



**U.S. GENERAL SERVICES ADMINISTRATION
COURTHOUSE MANAGEMENT GROUP**

MECHANICAL LIFT ANALYSIS

**(ACCESSIBILITY METHOD FOR ACCOMMODATION
OF PHYSICALLY DISABLED PEOPLE IN U.S. COURTHOUSE COURTROOMS)**

FINAL EDITION - MARCH 10, 2003



SUPPLEMENT - MARCH 17, 2005

**U. S. GENERAL SERVICES ADMINISTRATION
COURTHOUSE MANAGEMENT GROUP**

MECHANICAL LIFT ANALYSIS

TABLE OF CONTENTS

ACKNOWLEDGEMENTS

SECTION ONE

EXECUTIVE SUMMARY

FEASIBLE LIFT SYSTEMS	1-1
PLATFORM AND PIT STANDARDIZATION	1-2
RECOMMENDED DESIGN CRITERIA	1-2
CODES AND STANDARDS ISSUES	1-3
CONCLUSION	1-3
HYDRAULIC / SCISSORS LIFT	(ILLUSTRATION)
CANTILEVERED PLATFORM LIFT	(ILLUSTRATION)

SECTION TWO

EXISTING CRITERIA, CODES, AND STANDARDS

SUMMARY	2-1
EXISTING AGENCY CRITERIA	2-1
APPLICABLE CODES AND STANDARDS	2-2
(1) ADA STANDARDS FOR ACCESSIBLE DESIGN	2-3
(2) UNIFORM FEDERAL ACCESSIBILITY STANDARDS	2-3
(3) ICC / ANSI A117.1-1998	2-3
(4) ICC / ANSI A117.1-1992	2-3
(5) ASME A.18.1-1999 PLUS ADDENDA	2-4
SUMMARY OF THE MOST STRINGENT REQUIREMENTS	2-5

TABLE OF CONTENTS (CONTINUED)

SECTION THREE

DETAILED ANALYSIS AND FINDINGS

SUMMARY	3-1
PROBLEM ISSUES	3-2
FEASIBLE EXISTING SYSTEMS	3-4
DESIGN ISSUES	3-5
CODES AND STANDARDS COMPLIANCE	3-8
INSTALLATION	3-8
OPERATION	3-9
MAINTENANCE	3-10
RECOMMENDED PROTOTYPICAL	
PLATFORM LIFT ACCOMMODATION	(ILLUSTRATION)
OCCUPANT CONTROL POSITIONING	(ILLUSTRATION)
INSTALLATION CONFIGURATIONS	(ILLUSTRATION)

SECTION FOUR

CONCLUSIONS AND RECOMMENDATIONS

SUMMARY	4-1
CURRENT FUNCTIONAL ISSUES	4-1
SYSTEM SELECTION	4-2
DESIGN CONSIDERATIONS	4-3
CODES AND STANDARDS COMPLIANCE	4-3
INSTALLATION	4-4
OPERATION	4-5
MAINTENANCE	4-5
CONCLUSION	4-6

TABLE OF CONTENTS (CONTINUED)

SECTION FIVE

SURVEY RESULTS AND SITE VISIT FINDINGS

SUMMARY	5-1
BATON ROUGE, LOUISIANA	5-2
BROWNSVILLE, TEXAS	5-7
CORPUS CHRISTI, TEXAS	5-12
COVINGTON, KENTUCKY	5-16
DENVER, COLORADO	5-20
FARGO, NORTH DAKOTA	5-25
KANSAS CITY, MISSOURI	5-29
KNOXVILLE, TENNESSEE	5-35
LAFAYETTE, LOUISIANA	5-42
LAS VEGAS, NEVADA	5-47
MARICOPA COUNTY, ARIZONA	5-52
OMAHA, NEBRASKA	5-54
PHOENIX, ARIZONA	5-59
SCRANTON, PENNSYLVANIA	5-66
WILKES-BARRE, PENNSYLVANIA	5-70
WILLAMSPORT, PENNSYLVANIA	5-73
SUMMARY OF SURVEY & INTERVIEW RESPONSES	(SPREADSHEETS)

SECTION SIX

AVAILABLE MECHANICAL LIFT SYSTEMS

SUMMARY	(SPREADSHEETS)
PRODUCT SEARCH	6-1
MECHANICAL LIFT SYSTEMS COMPARISON	(TABLE)
(1) SOUTHWORTH / T.L. SHIELD	6-2
(2) GARAVENTA ACCESSIBILITY	6-4
(3) INCLINATOR COMPANY OF AMERICA	6-5
(4) ACCESS INDUSTRIES	6-6
(5) NATIONAL WHEEL-O-VATOR COMPANY	6-7
(6) ASCENSION	6-8
(7) CONCORD	6-9
(8) VERTICAL MOBILITY	6-10
(9) GIANT LIFT	6-11

TABLE OF CONTENTS (CONTINUED)

SECTION SEVEN

ANALYSIS PROCESS AND ACTIVITIES

<u>OVERALL PROCESS</u>	7-1
<u>SURVEY PROCESS</u>	7-2
<u>SURVEY GOALS AND INSTRUCTIONS</u>	7-2
<u>SURVEY</u>	(FORM)
<u>CONTACTS FOR SURVEYS AND SITE VISITS</u>	(SPREADSHEETS)

SECTION EIGHT

MECHANICAL LIFT ANALYSIS - SUPPLEMENT

PART 1 - ASSESSMENT OF THE SPIRALIFT SYSTEM

<u>PURPOSE OF THE SUPPLEMENT</u>	8-1
---	------------

SPIRALIFT SYSTEM

<u>DESCRIPTION OF THE SYSTEM AND ITS PRIMARY USES</u>	8-1
<u>CHARACTERISTICS OF THE BASIC DESIGN</u>	8-2
<u>ADAPTATION FOR ACCESSIBLE NEEDS</u>	8-2
<u>FEASIBILITY FOR THE COURTROOM ENVIRONMENT</u>	8-2
<u>NEW DESIGN</u>	8-3
<u>LIST OF ATTACHMENTS</u>	8-4

PART 2 - EVALUATION OF PORTABLE RAMPS AT THE JURY BOX

<u>PURPOSE OF THE SUPPLEMENT</u>	8-5
<u>OBSERVATIONS</u>	8-5
<u>MANUAL RECONFIGURATION FOR ACCESSIBLE ACCOMMODATION</u>	8-5
<u>MECHANICAL RECONFIGURATION FOR ACCESSIBLE ACCOMMODATION]</u>	8-6
<u>GENERAL ASSESSMENT</u>	8-6

TABLE OF CONTENTS (CONTINUED)

RECOMMENDATIONS

MINIMUM DESIGN CONSIDERATIONS (MANUAL RECONFIGURATION CONCEPT)	8-6
MINIMUM DESIGN CONSIDERATIONS (MECHANICAL RECONFIGURATION CONCEPT)	8-6

PHOTOGRAPHS TAKEN AT PACO CORPORATION

SIX INCH SPIRALIFT BEING CONNECTED TO INSTALLATION	8-7
STEEL SPRING BEING EXPANDED	8-8
SIX INCH SPIRALIFT AND SCISSORS GUIDE FOR 3 FT BY 5 FT PLATFORM	8-9

MECHANICAL LIFT SYSTEMS COMPARISON

COMPARISON CHART

PRODUCT LITERATURE

SPIRALIFT SYSTEM DESCRIPTION	
SPIRALIFT TUBULAR THRUST SCREW DESCRIPTION	
SIX INCH SPIRALIFT (NEXT GENERATION) CATALOG PHOTOGRAPH	
GENERAL SPECIFICATIONS AND ADDITIONAL PHOTOGRAPHS	
PLAN AND SECTIONS FOR A TYPICAL SPIRALIFT DESIGN	
DETAIL DRAWINGS	
PLAN AND SECTIONS FOR AN OFFSET CANTILEVER CONCEPT	
SPIRALIFT TANDEM SR EXTENDED CONFIGURATION DIAGRAM	
SPIRALIFT TANDEM SR DETAILS FOR THE DRIVE MECHANISM	
SPIRALIFT RIGID COLUMN DETAILS	
ILLUSTRATION OF THE TANDEM SR WITHIN THE COURTROOM ENVIRONMENT	

ACKNOWLEDGEMENTS

The successful accomplishment of this Analysis has been the result of valuable input from many people. In addition to those listed below, there are several people that made significant contributions by obtaining survey information and assisting at the site visits. These people are identified on the list of project contacts in Section 7 of the Report.

U.S. GENERAL SERVICES ADMINISTRATION COURTHOUSE MANAGEMENT GROUP

Gregory Segal, PMP
Project Director

UNITED STATES COURTS OFFICE OF THE CIRCUIT EXECUTIVE DISTRICT OF COLUMBIA CIRCUIT

Sara Delgado
Circuit Architect

LERCH, BATES, & ASSOCIATES, INC. ELEVATOR CONSULTING GROUP

Jay Popp, CEI

HDR ARCHITECTURE, INC.

Luis Pitarque
Rose Tillerson
Tom Niedbala
Tom Vanderveer
Gary Lewis
Greg Baird
Dan Pratt
Lynn Werman
Gerry Genrich

**U.S. GENERAL SERVICES ADMINISTRATION
COURTHOUSE MANAGEMENT GROUP**

MECHANICAL LIFT ANALYSIS

*(ACCESSIBILITY METHOD FOR ACCOMMODATION
OF PHYSICALLY DISABLED PEOPLE IN U.S. COURTHOUSE COURTROOMS)*

SECTION ONE

EXECUTIVE SUMMARY

The intent of this Analysis is (a) to develop a comprehensive understanding of the fundamental problems with current lift system designs and installations and (b) provide recommendations that serve as the basis for detailed performance criteria to eliminate these problems on future projects.

The main considerations that would lead to better functional performance are:

- Recognizing only two fundamental lift design concepts appropriate for the courtroom well environment;
- Standardizing the lift platform and pit dimensions;
- Developing planning guidelines, that effectively integrate the lift with other functional elements in the courtroom well;
- Formulating standard architectural details for all finish conditions, and incorporating them into the bidding documents;
- Optimizing the remote location of equipment;
- Refining the operation of the gate interlock system; and
- Formally removing the platform grab rail requirement.

FEASIBLE LIFT SYSTEMS

The two generic system designs most practical for this application were found to be: the hydraulic/scissors lift, with a remote hydraulic pump, and the cantilevered platform lift, incorporating a tower or mast element housing the operational apparatus. (Refer to the

diagrams of both systems at the end of this section.) Portable and inclined platform lifts were eliminated from consideration as practical solutions because of difficulties in maneuvering the portable unit in the courtroom and the necessary exposure of the apparatus related to an inclined platform system.

Limiting the feasible system concepts minimizes the impact on the design of the courtroom well. The only unique requirement that differentiates the two systems identified as practical for this situation is the equipment tower required for the cantilevered platform lift with the rear access panel for service, which can be concealed behind a wall.

PLATFORM AND PIT STANDARDIZATION

Without standardization of the platform size throughout the industry, it is impossible to determine specific dimensional requirements for incorporation of the system into the construction documents for bidding. This situation is the primary reason for inadequate coordination of finishes and details required for system incorporation.

Both the hydraulic/scissors and the cantilevered platform lifts will integrate better into the courtroom well environment if a pit is provided. This will allow the resting (non-operating) position of the lift to be at the lowest level, contiguous with the elevation of the adjacent courtroom well floor.

RECOMMENDED DESIGN CRITERIA

Every effort should be made to follow the suggested prototypical architectural planning layout, illustrated in *Section Three*, which includes the lift as an independent element. This concept will adapt to either of the recommended generic lift systems. It will also allow effective coordination of architectural detailing related to millwork, as well as platform finish conditions, to become part of the project construction documents for bidding.

Not all efforts to incorporate the lift platform into the normal path of travel to the witness box and judge's bench have been effective because of operational and architectural finish detail problems. These problems include the inability to maintain a raised position over an extended period of time (hydraulic / scissor lift) and excessive gaps between the platform and the fixed floor landing.

The basic architectural conditions that need to be included with the construction documents for bidding are the following:

- Courtroom well finish floor edge and return into the equipment pit;
- Lift platform surface finish and all edge conditions;

- Millwork enclosure and gates; and
- Equipment access panel finishes plus edge conditions.

The hydraulic system motor and its related electronics should always be located outside of the courtroom environment in an adjacent electrical or communications equipment closet.

It appears that problems with the gate interlocking system result from the system being continuously powered and overheating. Project specifications must include the requirement for wiring the gate interlocking system to allow power shutoff when the system is not in operation. The electromagnetic latch engagement at all access gates and the related electronics/controls of the system must be extensively tested before Substantial Completion of the project and acceptance of the system.

Specifications should require that the supplier identify and contract with a qualified service provider in the regional area of the installation in order to eliminate dependence on extremely remote sources of assistance and replacement parts.

CODES AND STANDARDS ISSUES

The consolidated most stringent requirements, detailed in *Section Two*, address the following design conditions:

- Net platform size;
- Controls locations;
- Gate dimensions;
- Enclosure height requirements;
- Running clearances;
- Platform/landing interface tolerances; and
- Platform grab rail requirements.*

*Recommend working with agency representatives to eliminate this requirement.

CONCLUSION

It was apparent that all the GSA staff, courts representatives, and architects of the 16 courthouses visited during the Analysis had put forth a very good effort to accommodate the mechanical lifts into the courtroom environment. Some had gone to extraordinary lengths to make the appearance of the lift as subtle as possible. In many of these instances, however, the good intentions have resulted in making the preparation for use and operation of the lift a complicated and time-consuming process.

The recommendations drawn from this Analysis, especially the development of detailed design and performance criteria, should help all those concerned to better plan for the

incorporation of the mechanical lift system into courtrooms at the appropriate time in the design process, with the least impact on the accommodation of functions in the courtroom well. The suggested performance criteria do not exclude any reputable manufacturer from bidding on lift system contracts.

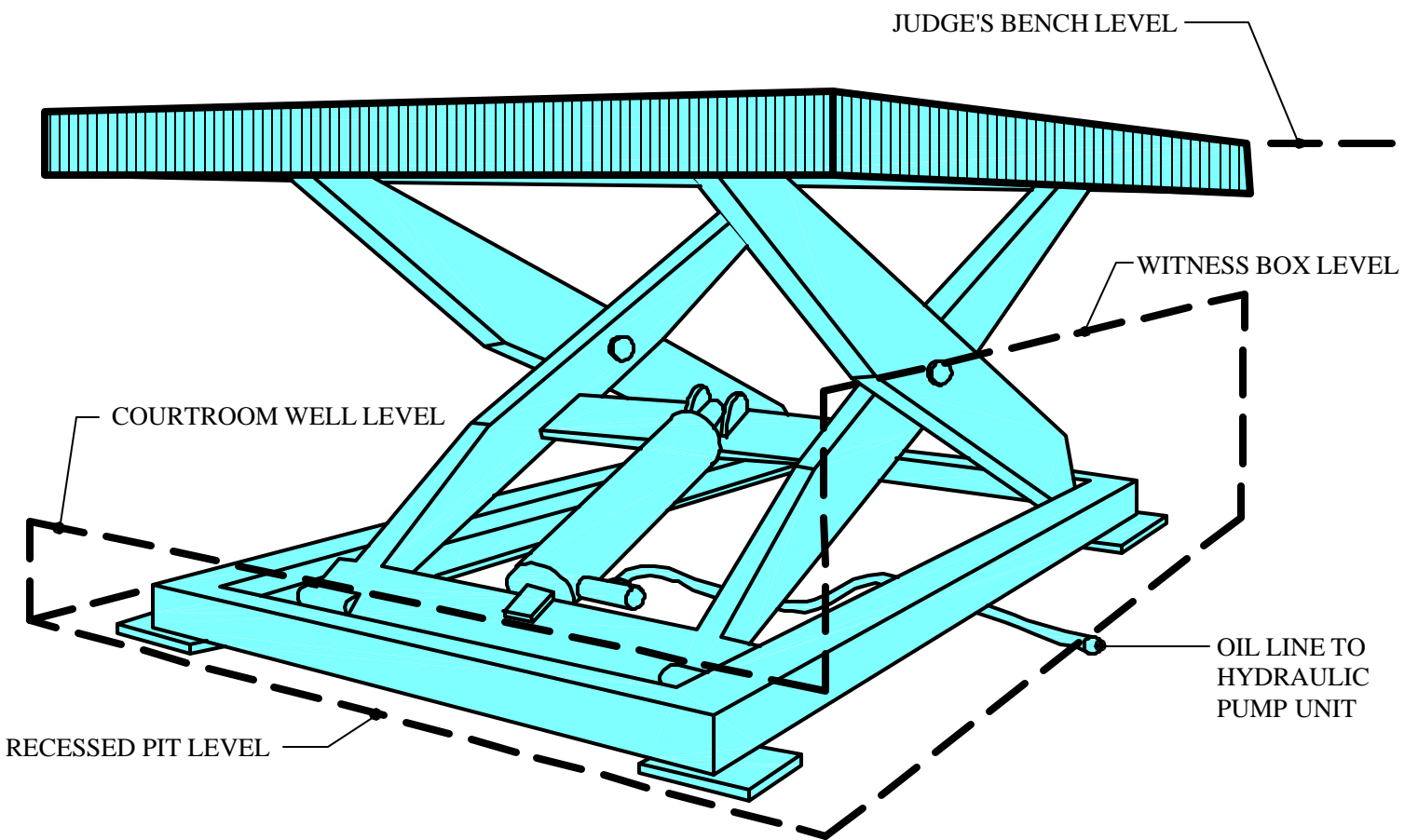

HYDRAULIC / SCISSORS LIFT

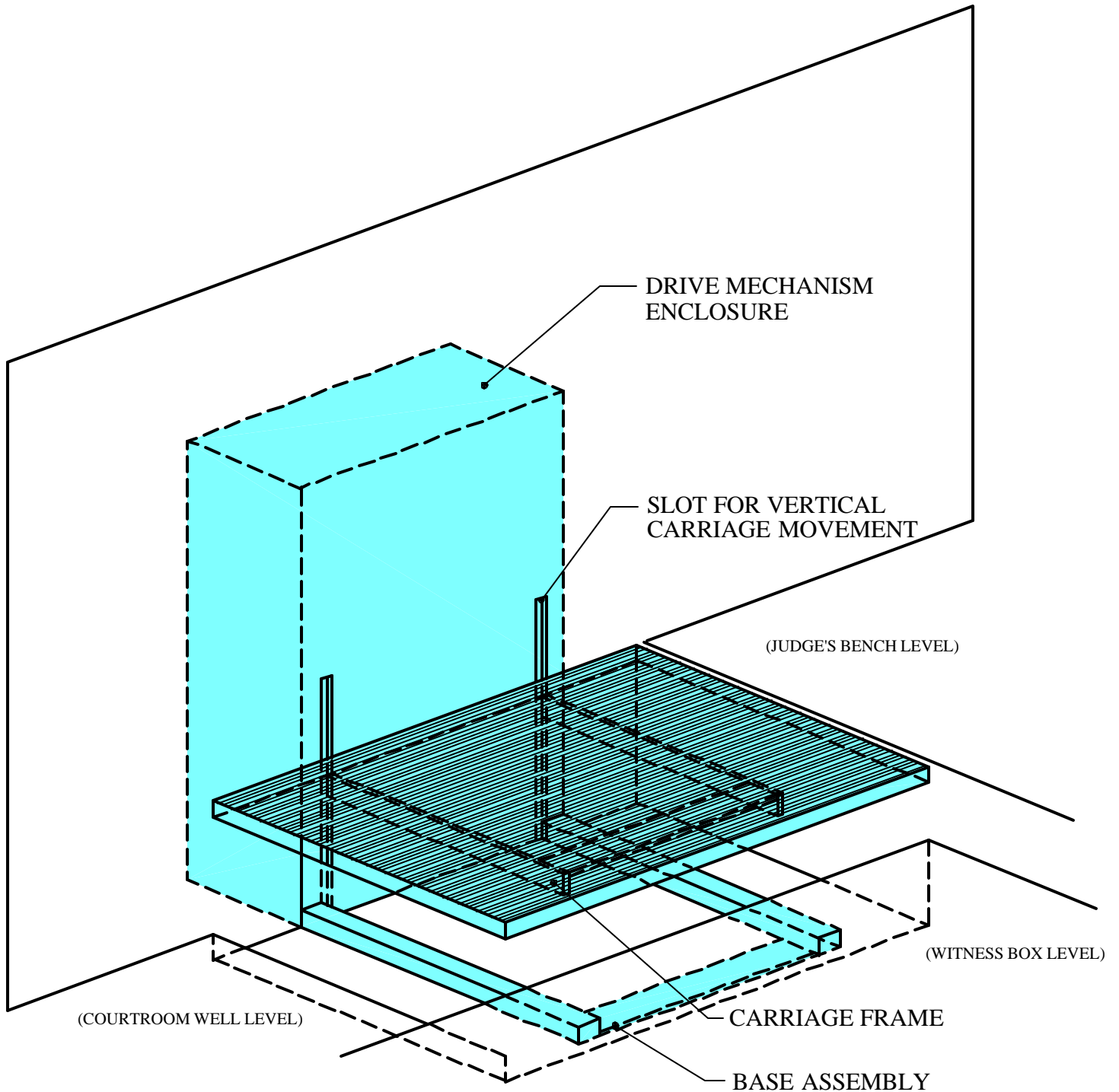

CANTILEVERED PLATFORM LIFT

SECTION TWO

EXISTING CRITERIA, CODES, AND STANDARDS

SUMMARY

Current performance criteria, provided by GSA and the Administrative Office of the U.S. Courts (AOUSC), are inadequate to ensure that a mechanical lift installation will meet industry minimum codes and standards. One of the major goals of this Analysis is to identify and consolidate the most stringent agency requirements, and then generate related performance criteria.

EXISTING AGENCY CRITERIA

The only directions currently given to the design A/E firm regarding function and placement of mechanical lifts within the courtroom environment are the following from GSA and AOUSC:

- GSA publication *PBS-100, Facilities Standards for the Public Building Service, Chapter 9, November 2000 edition*, states:

“ It is GSA and judiciary policy that all Federal courtrooms have the lectern, counsel tables, the witness box, and jury box accessible in the original design; and the judge’s bench, clerk’s station, and other court personnel workstations adaptable, regardless of local or state code.

Access to all raised areas in courtrooms requires lifts or permanent ramps. Since lifts must be an integral part of the architecture of the courtroom, bench areas will be designed to accommodate this equipment including structural slabs with a shallow pit for the lift platform. GSA and the U.S. Courts prefer the use of permanent lifts instead of ramps because they take less room, can be integrated into the design of the room, and are not tripping hazards. (Lifts are allowed by both UFAS and ADA.) ”

- AOUSC publication *U.S. Courts Design Guide, Chapter 4, 1997 edition*, makes only general reference to the requirement for lifts at the jury box, witness box, and judge’s bench within the diagrams that illustrate standard courtroom floor plans. (In the narrative information, Chapter 4 also mentions the option of using either ramps or lifts at all courtroom functions.)

APPLICABLE CODES AND STANDARDS

The following publications contain requirements pertaining to the design of vertical mechanical accessible lifts. All five regulatory standards are based on a “worst case” scenario where landings may be placed a maximum of 12 ft apart in vertical distance. (The maximum vertical travel distance between the courtroom well, witness box, and judge’s bench was never greater than 24 in. at the 21 installations investigated during this Analysis.)

- (1) ***Code of Federal Regulations (CFR)***
28 CFR Part 36
Americans with Disabilities Act (ADA) Standard for Accessible Design
(Revised July 1, 1994)
- (2) ***Uniform Federal Accessibility Standards (UFAS)***
Federal Standard 795
April 1, 1998
- (3) ***ICC/ANSI A117.1-1998***
American National Standard
Accessible and Usable Buildings and Facilities
(In conjunction with the International Building Code [IBC] 2000)
- (4) ***International Code Council (ICC) /***
American National Standards Institute (ANSI) A117.1 –1992
American National Standard
Accessible and Usable Buildings and Facilities
(In conjunction with the Building Officials
and Code Administrators, Inc. [BOCA] Code)
- (5) ***The American Society of Mechanical Engineers (ASME)***
Safety Standard for Platform Lifts and Stairway Chairlifts
ASME A18.1-1999 plus Addenda A18.1a-2000 and A18.1b-2001
(In conjunction with ASME A17.1-1993, where reference is made to this
document.)

The following summarizes the requirements from the five codes and standards that impact the design of the platform, enclosure surrounding the platform, control locations, and relationships between the platform and adjacent landing areas. The most stringent standard from each of the five codes and standards, related to a design issue, is indicated by (***Most Stringent***) and is included in the *Summary of the Most Stringent Requirements*.

(1) ADA Standards for Accessible Design

- (A) The minimum area required to accommodate a wheelchair is 30 in. by 48 in. When the wheelchair and occupant are on the lift and confined within three or four partitions, they must have an additional 6 in. clearance on the end of the platform and 12 in. clearance on the side. (The minimum clear platform area should be 36 in. by 60in., and the net area shall not exceed 18 sq ft.) (*Most Stringent*)
- (B) Side reach to the lift controls above the platform level, by the occupant in a wheelchair shall be within the range of 9 in. minimum to 54in. maximum in height.
- (C) Changes in level of more than ½ in. (in height) shall be accomplished by means of a ramp. (This condition may occur where the lift, in its lowest position resting on the frame, does not align with the elevation of the courtroom well.) (*Most Stringent*)

(2) Uniform Federal Accessibility Standards

This standard addresses 1A, 1B, and 1C, of ADA with the same requirements.

- (A) No removable barriers, including stair riser elements, shall be placed anywhere along the accessible route to the mechanical lift platform. (*Most Stringent*)

**(3) ICC/ANSI A117.1-1998
(In conjunction with the IBC 2000)**

- (A) End gates shall be a minimum of 32 in. in clear width. (*Most Stringent*)
- (B) Side gates shall be a minimum of 42 in. in clear width. (*Most Stringent*)
- (C) Openings in the floor (between the platform and enclosure) shall be of a size that does not permit the passage of a ½ in. sphere. (*Most Stringent*)
- (D) Same as 1A of ADA requirements.

**(4) ICC/ANSI A117.1-1992
(In conjunction with the BOCA Code)**

- (A) Same as 1A and 1C of ADA requirements.

- (B) Same as 1B of ADA requirements, but with a minimum side reach of 15 in.
- (5) **ASME A18.1-1999 plus Addenda A18.1a-2000 and A18.1b-2001**
- (A) Gates shall be self-closing and at least 42 in. high. *(Most Stringent)*
- (B) Gates shall be provided with a combination mechanical lock and electric contact. The locking device shall allow the gate to be opened only if the platform is within 2 in. of the landing. *(Most Stringent)*
- (C) The running clearance between the platform and landing shall be not less than 3/8 in. or more than 3/4 in. *(Most Stringent)*
- (D) A grab rail extending the full length of either side of the platform shall be provided at a height of 34 in. *(Most Stringent)*
- (E) Lift equipment pits are not required and a ramp shall be provided between the lowest lift level of the platform and the adjacent floor. (Retractable ramps, mounted to the platform, are allowed.) *(Most Stringent)*
- (F) The inside net platform area shall not exceed 18 sq ft. *(Most Stringent)*
- (G) The rated load on the platform shall not be less than 450 lb, or more than 750 lb. *(Most Stringent)*
- (H) Platforms with an area greater than 15 sq ft shall have a rated load of not less than 750 lb. *(Most Stringent)*
- (I) The lift shall be key operated from the upper and lower landings. *(Most Stringent)*
- (J) Deflection of the platform shall not exceed 3/8 in. vertically, if it is symmetrically loaded. *(Most Stringent)*
- (K) Platforms shall align vertically with each landing, within a 1/2 in. tolerance. *(Most Stringent)*
- (L) The lift shall be operated only by continuous pressure on the control button. *(Most Stringent)*

- (M) Controls shall be placed at a 48 in. maximum and 15 in. minimum distance above each landing floor and platform level. *(Most Stringent)*
- (N) The vertical runway for the lift platform shall be guarded by a solid enclosure extending from the lower landing to a height of at least 42 in. above the upper landing, including the height of the gates. *(Most Stringent)*

SUMMARY OF THE MOST STRINGENT REQUIREMENTS:

(Impacting the design of the lift platform, enclosure, and controls)

- *The minimum clear platform area shall be 36 in. x 60 in. and the net area shall not exceed 18 sq ft;*
- *Lift equipment pits are not required;*
- *Changes in level of more than 1/2 in. (in height) between the lift at its lowest position and the adjacent floor shall be accomplished by means of a ramp;*
- *Controls for the occupant shall be mounted in the range of 15 in. to 48 in. above the platform surface;*
- *End gates shall be a minimum of 32 in. in clear width;*
- *Side gates shall be a minimum of 42in. in clear width;*
- *Gates shall be at least 42 in. high;*
- *Openings between the platform and enclosure, at a landing, shall be of a size that does not permit passage of a 1/2 in. sphere;*
- *Gates shall be provided with a combination mechanical lock and electric contact. The locking device shall only allow the gate to open if the platform is within 2 in. of the landing;*
- *Running clearance between the platform and landing shall not be less than 3/8 in. or more than 3/4 in.;*
- *Grab rail running the full-length on one side of the platform shall be provided at a 34 in. height;*
- *Load limits on the platform shall be between 450 and 750 lb;*

- *Controls at the upper and lower landings shall be key operated;*
- *Maximum vertical deflection allowance of a symmetrically load platform shall be 3/8 in.;*
- *Platforms shall align vertically with each landing, within a 1/2 in. tolerance;*
- *Operation of the lift system shall be done by continuous pressure on the control button;*
- *A solid enclosure shall extend from the lower landing to a height of at least 42 in. above the upper landing, including the height of all gates; and*
- *No removable barriers, including stair riser elements, shall be placed anywhere along the accessible route to the mechanical lift platform.*

SECTION THREE

DETAILED ANALYSIS AND FINDINGS

SUMMARY

Topics and issues addressed in this section include:

- *A comprehensive summary of design, operational, and maintenance issues discovered during the Analysis;*
- *A description of the two most adaptable mechanical lift systems available, relative to the courtroom environment, and the three most common design configurations;*
- *Recommended standard architectural finishes and detail requirements;*
- *An analysis of the codes and standards issues applicable to the lift system indicating a minimum impact on the optimal design;*
- *Suggested refinements to the interlocking system that should significantly reduce maintenance problems as well as provide a basis for overall design and operational improvement;*
- *Opportunities for placement of mechanical lift equipment and related service access remote from the courtroom environment;*
- *General guidelines that should be developed for the service agreements, warranties, installation acceptance to be included in the construction documents for bidding on each project; and*
- *A recommended prototypical design for optimum incorporation of the lift into the functional components of the courtroom well. (Refer to the diagram entitled **RECOMMENDED PROTOTYPICAL PLATFORM LIFT ACCOMMODATION AT THE WITNESS BOX AND JUDGE'S BENCH** at the end of this section.)*

PROBLEM ISSUES **RELATED TO DESIGN AND INSTALLATION**

The following is a summary of the major functional problems discovered during this Analysis:

System Design

- ***There is lack of standardization by manufacturers for lift platform and pit sizes.***

The net useable area of the platform is dictated by code, but the gross area varies by manufacturer. Platform design variations among manufacturers are minimal and could be eliminated by provision of an industry standard.

- ***Operation of the electromagnetic lock system, interconnecting all the gates is sporadic.***

Problems with these systems are largely due to any one of three factors.

- (1) Continuously powered system, which at times this may lead to an overheated condition;
 - (2) Misalignment of lock components during construction; or
 - (3) Fatigue on the gates caused by inadequate support at the hinges.
- ***It is difficult to maintain a fixed position over extended periods (hydraulic lifts only).***

The dependence on hydraulic pressure to maintain a given landing stop height over an extended period is an issue because continuous pressure has been difficult to achieve in every instance reviewed in the Analysis.

Architectural Design

- ***Custom platform configurations are unstable.***

The standard system components are designed for a given load distribution. If the size and shape of the platform deviate from the manufacturer's design standard the system may be over-stressed to the degree of deviation from the original design intent.

Eighteen different configurations of the platform and/or the enclosure were incorporated at the 21 installations visited during this Analysis. (Refer to the *INSTALLATION CONFIGURATIONS* diagram at the end of this section.)

- ***Finish details at the platform and enclosure are currently adapted to field conditions for incorporation of the successful bidder's product, instead of being part of a comprehensive set of construction documents for bidding.***

Until there is basic standardization of the platform size, this situation will continue. Namely, finishes and details at the lift and enclosure will be adapted to field conditions rather than integrated as part of the entire design concept and included in the construction documents for bidding.

Codes and Standards

- ***Code and standards requirements are based on major height differences between the upper and lower landings.***

The requirements outlined in the previous section, from all five applicable regulatory standards are based on a “worst case” scenario where landings could be a maximum of 12 ft apart in vertical distance. (In contrast, the average distance between the courtroom well and the judge’s bench was actually not greater than 24 in. at all installations visited.)

Service

- ***Service and parts supplier are remotely located.***

Maintenance departments at most installations were dependent on both service and parts being supplied directly from the manufacturer, located thousands of miles away, thereby causing significant delays in reactivating the lift.

Agency Requirements (GSA/AOUSC)

- ***There is a lack of comprehensive guidelines for design and installation of system equipment that minimizes the impact of the lift and its components on the design of the courtroom well.***

The manufacturers of the cantilevered platform lift can provide access to the operating mechanism from the back of the tower, outside of the courtroom, but this concept was not utilized.

The hydraulic motor and electrical panel should be placed in a closet outside of the courtroom instead of under the judge's bench, but at least 80 percent of the installations had the equipment located under the judge's bench.

The appropriateness and completeness of finish details at the lift platform and enclosure were inconsistent because of the lack of standards for these conditions.

General

- ***At the outset of the Analysis, it was expected that vibration and noise during operation would be a significant issue.***

Based on 16 site investigations, vibration and noise during operation was determined to be minimal.

FEASIBLE EXISTING SYSTEMS:

From a review of the 16 installations visited and the nine manufacturers investigated, it became clear that only two system design concepts could provide the performance required while minimizing the impact on the courtroom environment and proceedings. The two systems are the hydraulic/scissors lift and the cantilevered platform lift. This Analysis focuses exclusively on the attributes, and strengths/weaknesses of the two systems.

Hydraulic/Scissors Lift

The hydraulic/scissors lift depends on hydraulic pressure for raising, lowering, and maintaining the platform in an elevated position. The electrical panel and drive motor can be in a location remote from the platform area. Hydraulic cylinders that raise and lower the platform are mounted on the pivoting scissors support frame. (Refer to the *HYDRAULIC/SCISSORS LIFT* diagram at the end of *Section One*.)

Cantilevered Platform Lift

The cantilevered platform lift system includes a tower containing the Acme screw drive mechanism and supports for the cantilevered arms that raise or lower the lift platform. All system apparatus is located in the tower with the exception of a stabilizing base frame, which extends to the full dimensions of the lift platform. (Refer to the *CANTILEVERED PLATFORM LIFT* diagram at the end of *Section One*.)

Both Lift Systems

The basic model, is competitively priced.

Some manufacturers have converted industrial lift designs, used for moving materials from level to level in a warehouse environment into versions being marketed for use by the physically disabled.

DESIGN ISSUES:

INTEGRATION OF THE LIFT SYSTEM INTO THE COURTROOM

There are three basic lift and enclosure planning configurations which allow access to both the witness box and the judge's bench in a typical courtroom.

Lift Platform (Entire Witness Box Floor)

The platform remains at an elevated position except when in operation to accommodate a physically disabled person.

If this elevated position is maintained by hydraulic pressure the possibility of the lift sinking over time is predictable. (The manufacturers of this type of unit have tried to correct the problem by replacing valves within the hydraulic system.)

An alternative to constant dependence on hydraulic pressure to maintain the height could be a set of retractable struts at each of the four corners of the lift platform. (When the struts are set in position, by a switch on the lift control panel, they form four legs supporting the platform. This allows the hydraulic pressure to be released.)

In the opinion of Lerch, Bates & Associates, Inc., it currently could be cost prohibitive for manufacturers to invest in the development of a four-cornered strut system.

Lift Platform (Partial Section Of Witness Box Floor)

This configuration results in the most complex lift system design, particularly when it services both the witness box and judge's bench at two independent elevated levels.

Mechanically operated wheel stop components, located at the lift edge facing the witness box and the fixed floor edge of the witness box, are required for operating the system in this configuration. (Refer to photographs of these conditions in *Section Five*.) The lift platform wheel stop extends when the platform moves up past the witness box level. The wheel stop at the witness box extends only when the lift platform is at the lower courtroom well floor level elevation. The finish conditions at the wheel stops were not well executed at the installations reviewed during the site visits.

Lift Platform (Independent Element) Recommended Concept

This configuration was not utilized at any of the 16 sites visited, largely because it consumes more courtroom well space than the other two alternatives. The dedication of 15 to eighteen 18 sq ft of area for this function is more than compensated for by eliminating dependence on the operation of the lift system to accommodate all people using the witness box.

DESIGN CRITERIA FOR THE LIFT SYSTEM

Guideline Requirements

To solve many of the problems identified during this Analysis, a series of focused and detailed design criteria must be incorporated into both the *U.S. Courts Design Guide* and the *GSA Facility Standards for the Public Building Service*. These criteria needs to address effective planning accommodation within the courtroom well environment; standardization of the platform size and pit depth; and finish and detail requirements for all architectural elements.

Recommended Prototypical Configuration

The most practical solution, in terms of interface with the witness box and judge's bench, is an independent lift and enclosure. This design would allow by-pass of the entire lift system under normal operating conditions when ambulatory individuals occupy the witness box or the judge's bench. (The **RECOMMENDED PROTOTYPICAL PLATFORM LIFT ACCOMMODATION** diagram at the end of this section illustrates the typical arrangement of the lift, witness box, and judge's bench in this design concept.)

Standard Platform Size

Industry standardization of system components must be accomplished, or GSA will need to dictate platform size. Concurrently, code/standard agencies must be encouraged to eliminate railing requirements that presently impact the size of the platform, depending on the manufacturer's required rail mounting or stanchion placement. Both of these issues must be resolved in order to achieve uniform dimensions to accommodate lift systems.

Pit Requirements

A pit is required for the lift system base supports in order to eliminate the need for a transition ramp between the courtroom well floor level and the platform at its lowest position, which is always slightly elevated because it rests on the base frame.

The depth of the base frame and attached equipment varies depending on the system design. (The cantilever platform lift design requires a maximum of a 4 in. recess, while the hydraulic/scissors concept needs as much as 8 in.) This variance is due to the fundamental differences in the design of the two (2) systems.

If it is the intent of GSA to keep options open for attracting several manufacturers of both systems to the bidding process, the guidelines must indicate a required pit depth of 8 in.

The structural engineer on the design A/E team should be made aware of the size and placement of each pit during the preparation of construction documents for bidding, and then be able to adapt the pit depth to the lesser dimension in the shop drawing review process if the manufacturer of the cantilevered platform system is the successful bidder.

Standard Lift Accommodation

The lift must be recognized as a piece of equipment, or machinery, that needs to be accommodated in its standard configuration in order to achieve the intended performance. Rarely does the architect dictate the shape of a mass-produced service element within the built environment. The designer must recognize the functional limits of the standard lift and incorporate them into the overall plan configurations and millwork elements for the courtroom.

Providing the lift system and the related enclosure elements as independent design elements, as this Analysis recommends, would eliminate several of the design and functional problems observed during the site visits, including the need for a retained raised platform condition, and the requirement for wheel-stop elements between levels.

Integrated Architectural Finishes and Details

GSA must develop design criteria, including an outline of all conditions requiring comprehensive architectural detailing related to the lift system installation.

Architectural finishes for the lift enclosure and platform surface should be thoroughly addressed as part of the project construction documents for bidding. Throughout this Analysis it was apparent that most lifts, and the related enclosure elements, were integrated as part of the product *Submittal for Approval* process during the construction administration phase of each project. This is not the appropriate time to develop millwork and floor finish details, because related construction trades have already committed to their scope of work on the project. The minimum basic architectural conditions requiring detailing are:

- Courtroom well finish floor edge and return into the equipment pit;
- Lift platform surface finish and all edge conditions;
- Millwork enclosure, including gates; and**
- Remotely located equipment access panel finishes, plus edge conditions.

**

(Gate construction, hinges, and related anchoring should be very durable, because of the substantial material weight and cantilever loading condition.)

CODES AND STANDARDS COMPLIANCE

From a review of the five applicable sets of regulations governing the design of vertical mechanical lifts, it is apparent that these requirements are focused on design conditions that have significantly greater elevation changes between landings than are required in the courtroom.

Handrails

Handrails, mounted on the platform, are currently required by code. Nearly all the installations visited during the Analysis did not include them, however, because the requirement was eliminated by code variance. It is highly probable that code officials would support a request by GSA for modified language, which would eliminate the handrail requirement for elevation changes of 24 in. or less.

Platform Occupant Controls

Careful measurement of lift occupant controls, using code guidelines relative to the elevation of the highest and lowest landings, would allow mounting on the wall in lieu of attachment to the platform. (Refer to the *OCCUPANT CONTROL POSITIONING* diagram at the end of this section.)

Platform Size

Regulations only dictate the net area of the platform size. When a panel is attached to the platform with a stanchion (hydraulic/scissors lifts) or a handrail (cantilevered platform lifts) mounted to it, the gross platform area may have some significant dimensional variations between the designs. Regardless of the handrail requirement, the lack of an industry standard for the overall platform size will continue to be the most significant issue interfering with the ability to provide comprehensive detailing of the lift enclosure within the construction documents for the bidding phase. The reason is that the exact dimensions of the platform will not be known until the successful bidder is identified.

INSTALLATION

Performance Requirements

A performance checklist developed by GSA, and included with the design criteria, would significantly benefit building facility engineers in evaluating the installation prior to official acceptance. These performance requirements must be addressed in the

specification/general condition requirements as part of the construction documents for bidding on each project.

Some of the issues that should be addressed at the time of installation include:

- Lift platform support framing being out of balance, resulting in excessive vibration and noise;
- Misalignment of the platform, within the enclosure, causing rubbing against the adjacent lift enclosure surfaces;
- Jerking or slipping sensation requiring adjustments to the drive mechanism; and
- Proper sequencing of operation controls.

OPERATION

Interconnected Locking System – Enclosure Gates

Interconnected electromagnetic locking systems are required by code. There are no known alternative systems that ensure the occupant against a condition where the gate could open between a lower floor level and an elevated platform condition.

Most of the problems with the electromagnetic system identified during this Analysis are not due to a quality issue relative to the electronic strike device itself, but are due to the method in which the electronic strike is typically incorporated into the circuits of the lift system.

The failure and/or intermittent operation of the electronic strikes occur because in most systems, strikes are continuously powered. This condition causes the armatures within the strike to overheat whether the lift is in use or not. The fact that the armature is always energized presumably causes the armature to “hang up” until the access panel or gate is jiggled, thereby freeing up the armature and allowing the switch to function properly.

The solution to this problem is to energize the electronic strike mechanism only when the lift is actually in operation. This can be accomplished by either (a) connecting the “common” wire on the electronic strike through to the key switch, which activates the lift prior to use, or (b) adding a switch to sense the position of the access panel or gate and utilizing this switch to energize or de-energize the circuit powering the electronic strike, based on whether the access panel or gate is open or closed.

This is a relatively simple modification to existing systems and specifications for future projects. This approach should be investigated further to determine if, in fact, it would provide a simple means of correcting the deficiencies noted at several of the existing

courthouse facilities where apprehension in utilizing the lifts was noted in surveys during site visits. (For the survey and site visit findings for each location, see *Section Five*.)

MAINTENANCE

Service Access

Standards for the provision of service access requirements for all system components must be developed and included in the design criteria. A distinction should be made between service requirements for system operational control components and those related to the platform supports and system frame. The former would require the vast majority of the service during the life of the system.

Electronics and electrical system elements, other than those included at the operational panel mounted on the lift enclosure, should be remotely located in an electrical or communications closet containing other equipment related and adjacent to the courtroom. All the lift systems investigated have similar limited access requirements for component servicing. Their generic requirements include:

(1) Elements below the platform

Hydraulic/scissor units

- *Base frame and pivoting scissors bars*
- *Hydraulic cylinders and lines*

Cantilevered platform units

- *Base frame*

(2) Remote equipment

Hydraulic/scissors units

- *Electrical panel*
- *Hydraulic system motor*

Cantilevered platform units

- *Electrical panel*

(3) Integral adjacent/concealed equipment

Hydraulic/scissors units

- none

Cantilevered platform units

- Drive mechanism in recessed tower*

*The cantilevered platform drive mechanism can be designed for front or rear service access.

Requirements for Regional Service and Parts

The project specifications and related general conditions should state that the lift system supplier be required to contract for service, for at least a 10 year period. Further, the contract should be with a proven reputable and experienced company that has system parts on hand, within a 500-mile radius of the installation site.

Warrantees

The project specifications should include a minimum requirement of a 10-year warrantee on all parts and operating controls.

System Cycling Requirement

The manufacturer of the lift system provided at a majority of the installations investigated in this Analysis T.L. Shields, requests that each lift unit be cycled through its operation sequence at least once a month to retain the hydraulic pressure while the platform is at a normal elevated position. Since the lift is rarely used, it does appear to be unrealistic to expect building maintenance to cycle through the operation sequence and test for leaks every month. The retention of the platform at an elevated position must be accomplished by means other than hydraulic fluid pressure.

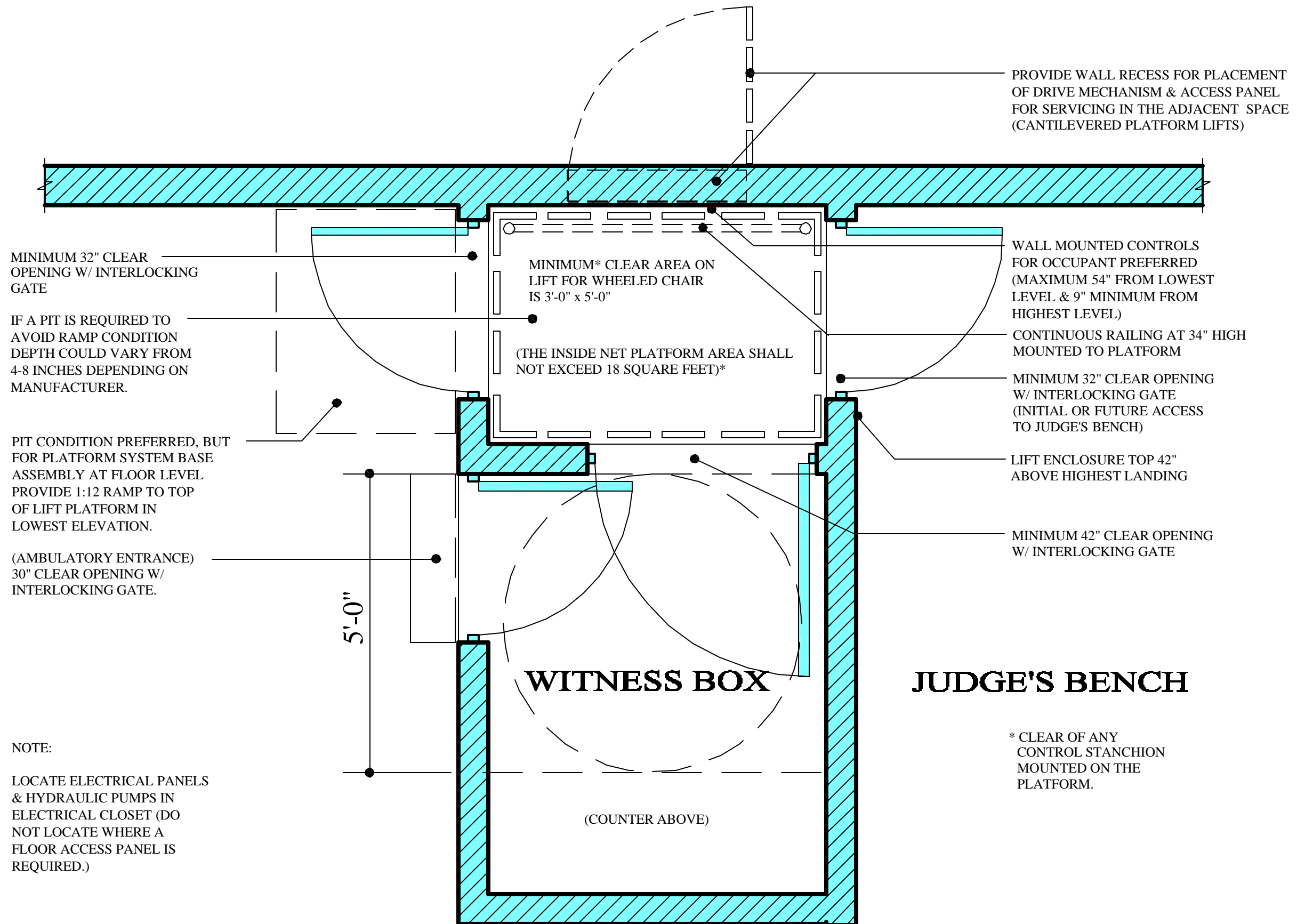

MINIMUM 32" CLEAR
OPENING W/ INTERLOCKING
GATE

IF A PIT IS REQUIRED TO
AVOID RAMP CONDITION
DEPTH COULD VARY FROM
4-8 INCHES DEPENDING ON
MANUFACTURER.

PIT CONDITION PREFERRED, BUT
FOR PLATFORM SYSTEM BASE
ASSEMBLY AT FLOOR LEVEL
PROVIDE 1:12 RAMP TO TOP
OF LIFT PLATFORM IN
LOWEST ELEVATION.

(AMBULATORY ENTRANCE)
30" CLEAR OPENING W/
INTERLOCKING GATE.

NOTE:

LOCATE ELECTRICAL PANELS
& HYDRAULIC PUMPS IN
ELECTRICAL CLOSET (DO
NOT LOCATE WHERE A
FLOOR ACCESS PANEL IS
REQUIRED.)

MINIMUM* CLEAR AREA ON
LIFT FOR WHEELED CHAIR
IS 3'-0" x 5'-0"

(THE INSIDE NET PLATFORM AREA SHALL
NOT EXCEED 18 SQUARE FEET)*

5'-0"

WITNESS BOX

(COUNTER ABOVE)

PROVIDE WALL RECESS FOR PLACEMENT
OF DRIVE MECHANISM & ACCESS PANEL
FOR SERVICING IN THE ADJACENT SPACE
(CANTILEVERED PLATFORM LIFTS)

WALL MOUNTED CONTROLS
FOR OCCUPANT PREFERRED
(MAXIMUM 54" FROM LOWEST
LEVEL & 9" MINIMUM FROM
HIGHEST LEVEL)

CONTINUOUS RAILING AT 34" HIGH
MOUNTED TO PLATFORM

MINIMUM 32" CLEAR OPENING
W/ INTERLOCKING GATE
(INITIAL OR FUTURE ACCESS
TO JUDGE'S BENCH)

LIFT ENCLOSURE TOP 42"
ABOVE HIGHEST LANDING

MINIMUM 42" CLEAR OPENING
W/ INTERLOCKING GATE

JUDGE'S BENCH

* CLEAR OF ANY
CONTROL STANCHION
MOUNTED ON THE
PLATFORM.

**RECOMMENDED PROTOTYPICAL PLATFORM LIFT ACCOMMODATION
AT THE WITNESS BOX AND JUDGE'S BENCH**

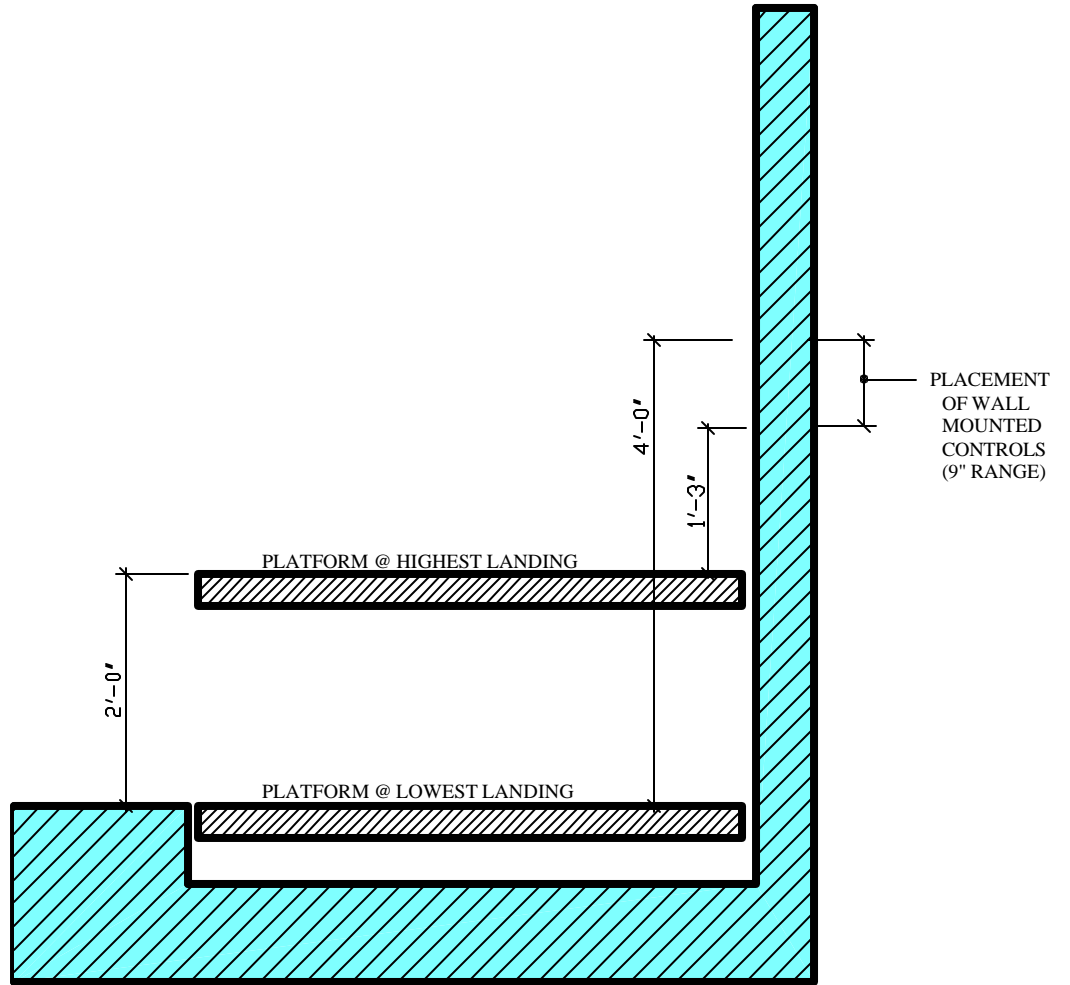

OCCUPANT CONTROL POSITIONING

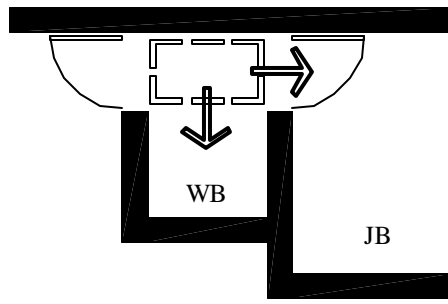

LAS VEGAS

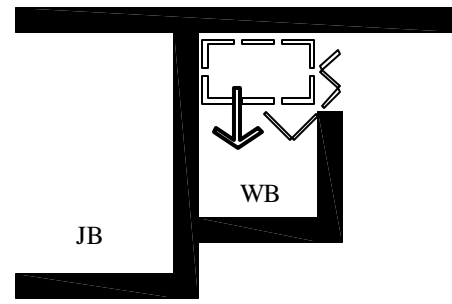

PHOENIX

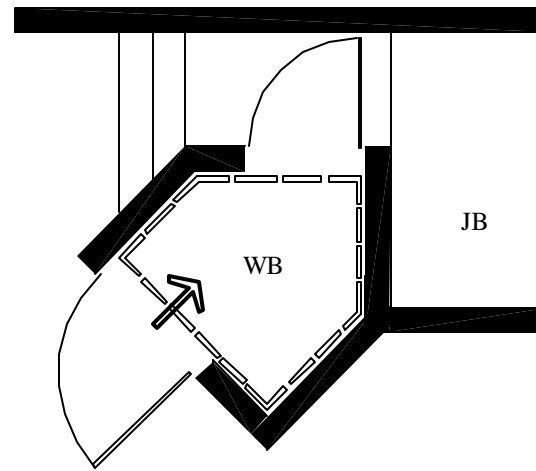

OMAHA

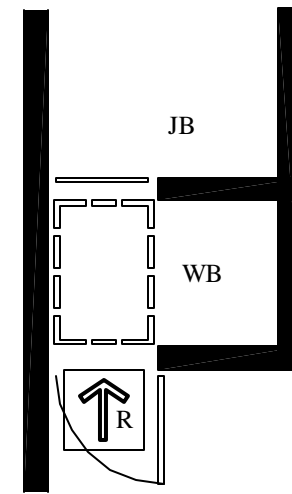

SCRANTON

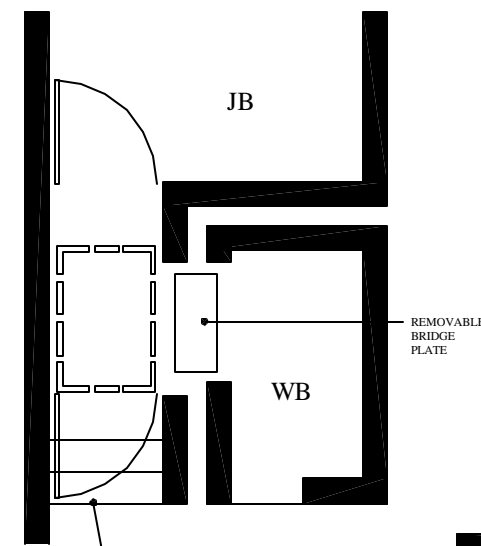

KNOXVILLE

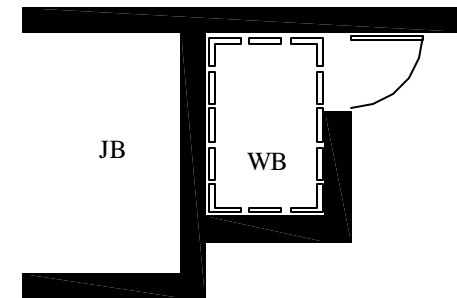

WILLIAMSPORT

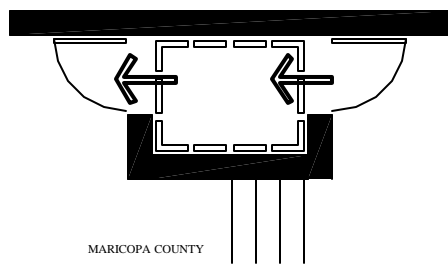

MARICOPA COUNTY

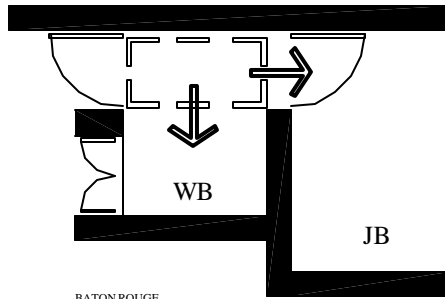

BATON ROUGE

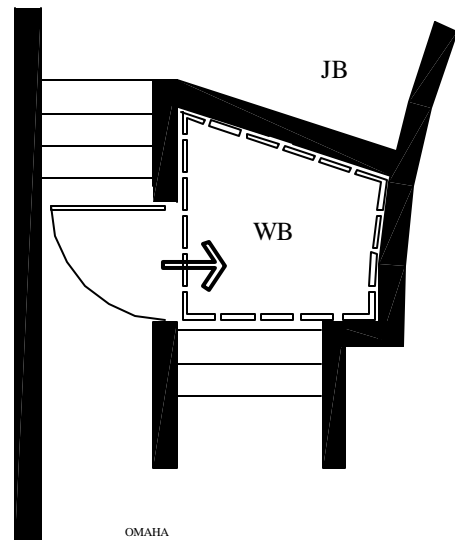

OMAHA

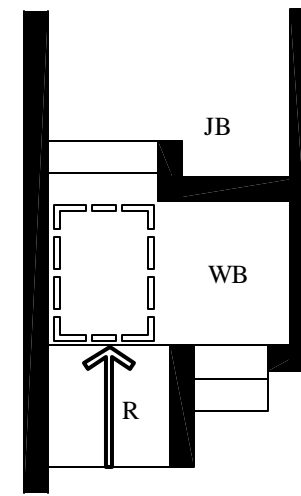

FARGO

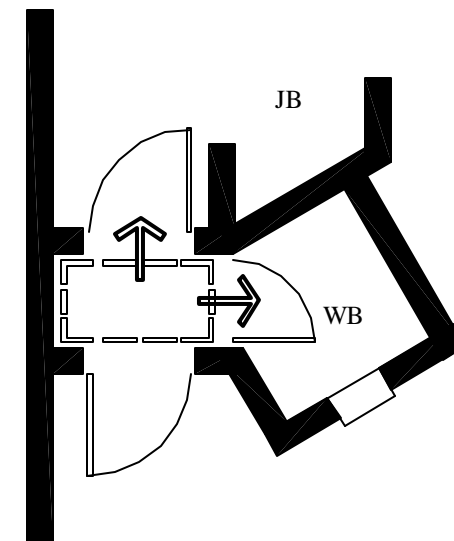

COVINGTON

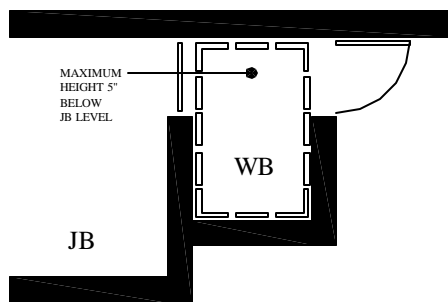

LAFAYETTE

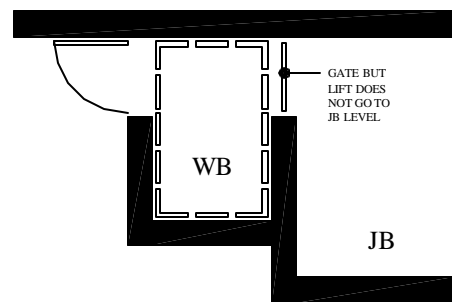

CORPUS CHRISTI

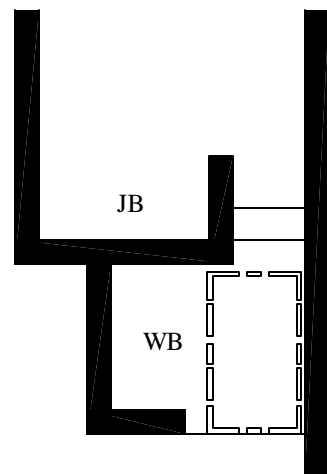

BROWNSVILLE

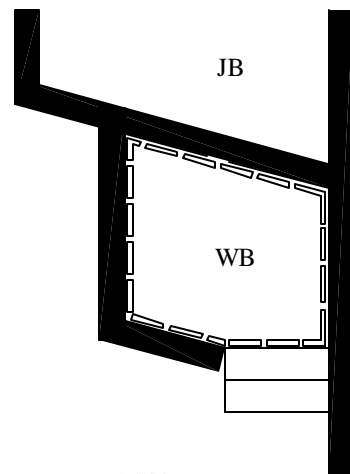

KANSAS CITY

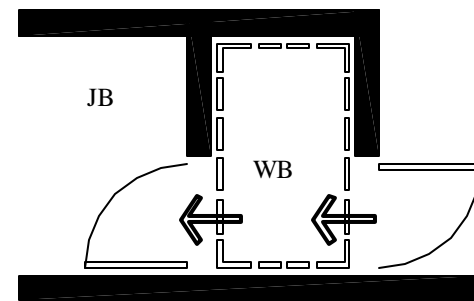

WILKES-BARRE

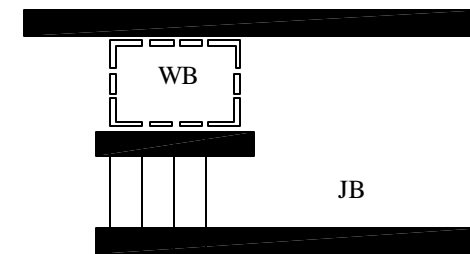

DENVER

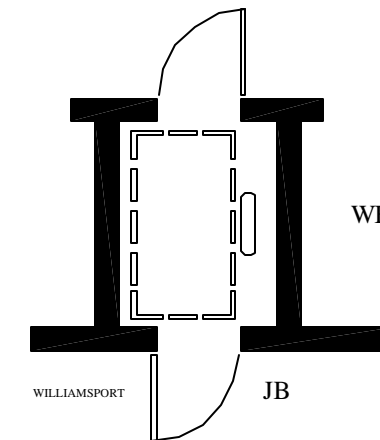

WILLIAMSPORT

INSTALLATION CONFIGURATIONS

SECTION FOUR

CONCLUSIONS AND RECOMMENDATIONS

SUMMARY

The desire of both GSA and the U.S. Courts to maintain a competitive bidding environment requires that suggested improvements in the design, installation, operation, and maintenance of the lift system and its components must be very practical in nature.

The Analysis has identified two system concepts that are feasible in the courtroom environment. Both systems easily can be accommodated in the recommended independent planning configuration. Standardization of the lift platform size would allow all architectural detailing to be incorporated into the construction documents prior to bidding. Concealing support equipment and related service access outside of the courtroom and working with regulatory agencies to eliminate the handrail requirement would leave the control buttons, mounted on the lift enclosure, and the platform surface as the only exposed system elements in the architectural environment.

CURRENT FUNCTIONAL ISSUES

Survey responses, site visit observations, and a review of applicable regulations during the Analysis generated the following summary of issues regarding system design, operation, and maintenance:

- Absence of dimensional standardization for the lift platform among the systems most feasible for accommodation into the courtroom environment;
- Codes and standard requirements that apply to conditions greatly exceeding the risks experienced at the lift installations in the courtroom setting;
- Many recent custom designs, which over-stress standard design lift systems;
- Nonexistence of planning guidelines that establish an effective relationship between the lift and the witness box/judge's bench;
- Enclosure gates that have unreliable operation;
- Inability of hydraulic pressure to maintain a suspended platform over an extended period of time; and

- Lack of design criteria related to architectural finishes and details.

SYSTEM SELECTION

Feasible Concepts

The hydraulic/scissors lift, the dominant system in use at the installations visited, is vulnerable to several functional problems. All of these problems could be addressed with relatively minor design considerations.

The cantilevered platform lift is a reliable alternative system because of the platform stability achieved with the Acme screw drive mechanism; however, operating equipment integration requires an approximately 40 in. wide by 12 in. deep and 48 in. high wall recess space located immediately adjacent to the lift platform.

Recommendations:

The suggested GSA/AOUSC performance criteria are as follows:

Hydraulic/scissors lift improvements

- Require retractable struts for sustained platform support at an elevated level; and
- Always locate the hydraulic motor and electrical apparatus outside the immediate courtroom environment.

Cantilevered platform lift improvements

- Maximize utilization of a service access panel at the back of the equipment tower.

Common improvements

- Standardize platform plan dimensions.

A specific lift system should not be selected until the GSA Project Manager is able to observe a manufacturer's product, first hand, in a courtroom installation and then assess its functional performance.

DESIGN CONSIDERATIONS

Independent Lift System

The best functional planning scenario is to put the lift in use only when a physically disabled person requires it for access to the witness box or judge's bench. An independent lift system and enclosure require approximately 15 to 18 sq ft of dedicated space within the courtroom well.

Standardization of Basic Elements

Once the planning configuration, platform size, and pit depth become standard; all related architectural finishes and detailing can be incorporated into the construction documents for bidding, with a minimum risk for change in adaptation to the selected lift system.

Recommendations:

The suggested GSA / AOUSC performance criteria for information to include in the project construction documents for bidding are as follows:

- Incorporate the prototypical independent platform lift configuration relative to the witness box and judge's bench as the standard;
- Develop a standard platform size in conjunction with code and standard requirements;
- Require a standard pit depth, to accommodate the hydraulic/scissors design (greatest depth required) and eliminate the need for a transition ramp at the lowest floor level in all cases; and
- Specifically describe all required finish material selections and detail conditions.

CODES AND STANDARDS COMPLIANCE

The most significant requirements that impact the design of the lift system and enclosure are those related to platform size, enclosure height, gate width, placement of system controls above the platform level, and handrails.

Standardization of the platform plan dimensions must reflect the code / standards requirement for a clear platform area of 36 in. by 60 in.

The minimum dimensional requirements related to the lift enclosure include:

- 42 in. height above the upper landing;
- 32 in. clear gate width at end conditions;
- 42 in. clear gate width at side conditions; and
- 39 in. to 48 in. height range above the lowest level for operator control placement (when the highest landing is located 24 in. above the lowest level).

Recommendation:

GSA and AOUSC should work with regulatory agencies to amend the handrail requirement so that the maximum vertical height distances between landings of 24 in. or less (typical for conditions between the courtroom well, the witness box, and the judge's bench) do not require a handrail.

INSTALLATION

Currently, there are at least four distinctly different standard lift system designs that could be incorporated into the courtroom well condition, not to mention the many custom designs that were observed during the site visits. This situation limits the ability to define the standard criteria used to check the initial installations for functional performance before acceptance.

Recommendations:

Assuming that GSA/AOUSC will limit the acceptable design concepts to the hydraulic/scissors and cantilevered platform systems, and not allow customization of the platform shape, the following issues, at a minimum should be addressed in performance criteria, and checked by the GSA Project Manager, before official system acceptance from the manufacturer:

- Check for excessive noise and vibration, which could indicate that the system is out of balance;
- Make sure that the platform is not rubbing against the enclosure because of misalignment;
- Test for a smooth ride, and if there is a sense of jerking or slipping, make adjustments at the drive mechanism;
- Run through the entire sequence of operations at each control station several times to ensure that they function correctly; and

- Verify that all gate interlocks operate correctly and are wired or switched to avoid the need for continuous power application.

OPERATION

The most significant problem with the operation of the lift system, as determined by the surveys and site visits, was a lack of confidence in the dependability of the interconnected locking system between the enclosure gates. (It could be a misconstrued opinion that the problem was caused by misalignment of the locking components on the gate and frame. The actual problem may be overheating of the armature because of continuous power being applied to the system.)

Recommendation:

GSA/AOUSC should confirm that the problem is as described and if so, do the following:

- For existing conditions, either connect the “common” wire on the electronic strike through to the key switch, which activates the lift prior to use, or add an additional switch to sense the position of the gate and utilize this switch to energize/de-energize the circuit strike, based on whether the gate is open or closed; and,
- For new designs, GSA/AOUSC must make sure that this refinement to the system is included in the wiring / switching requirements as part of the performance criteria, and GSA Project Managers need to review project specifications for compliance.

MAINTENANCE

The majority of operational parts for each of the two recommended system design concepts could be remotely located from the immediate courtroom environment to allow unlimited access for repairs. In most of the installations investigated, however, this was not the case. (Note the recommendations outlined under SYSTEM SELECTION in this section.)

In many of the installations investigated, service and parts for the lift equipment were provided only by the manufacturer located an extensive distance from the site, causing delays in completing repairs.

Recommendations:

The suggested GSA/AOUSC performance criteria are as follows:

- Require that the lift supplier contract with a local qualified service representative, who will maintain parts in stock, for a minimum period of 10 years; and
- Require that the project specifications include a minimum of a 10-year warrantee on all parts and operational controls.

CONCLUSION

Problems that have resulted at the lift system installations investigated were largely due to the lack of comprehensive performance guidelines. GSA had anticipated this situation, which is one of the main reasons for this Analysis. The related recommendations will form the basis for future guidelines.

Attempts to incorporate the lift platform into the required general circulation path to the witness box and judge's bench, and to eliminate the need for dedicated space in the courtroom well area, have not been successful. These attempts have led to significant service problems.

The disappointing results, particularly related to finish materials and details, are partially due to lack of platform size standardization within the industry. Because of this situation, GSA needs to limit the acceptable system design alternatives to those that can meet the anticipated redefined performance expectations. Dimensional limits should be included to assist the design A/E firm with effective integration of the architectural finish and detail requirements into the construction documents for bidding.

General maintenance challenges can be reduced with more stringent guidelines related to: requirements for regional service and parts; refinements to the interconnecting gate-locking system; a checklist review of the system before acceptance; and equipment warrantees.

SECTION FIVE

SURVEY RESULTS AND SITE VISIT FINDINGS

SUMMARY

This section is a consolidation of the information obtained during the survey process, interviews, and observations at the sites of the sixteen 16 installations.

Survey materials and a detailed list of all agency contacts participating in this Analysis are included in *Section Seven*.

The synopsis for each of the 16 site locations includes an outline of performance characteristics, a diagrammatic floor plan, and photographs of the immediate lift environment. (The plan diagrams include symbols indicate the direction of related photographs.)

Issues that appear in *red italics* identify problems with the particular lift system installation, and those that appear in *green italics* represent good design solutions.

At the end of this section is a summary matrix comparing the 16 installations, as they relate to the extensive list of performance criteria. Where a relatively consistent problem area for effective performance was indicated at several installations, a statement was placed in the right margin of the matrix summarizing the issue or issues.

(All of the identified performance issues are summarized and discussed in detail as part of the DETAILED ANALYSIS / FINDINGS in *Sections Three* of the Analysis.)

MECHANICAL LIFT ANALYSIS

SUMMARY OF SURVEY & INTERVIEW RESPONSES, PLUS SITE OBSERVATIONS

(INFORMATION IS BASED ON 38 RETURNED SURVEYS & INTERVIEWS FROM A TOTAL OF 18 LOCATIONS, PLUS 16 SITE VISITS)

File: sursum.j19

	BATON ROUGE, LOUISIANA	BROWNSVILLE, TEXAS	CORPUS CHRISTI, TEXAS	COVINGTON, KENTUCKY	DENVER, COLORADO	FARGO, NORTH DAKOTA	KANSAS CITY, MISSOURI	KNOXVILLE, TENNESSEE	LAFAYETTE, LOUISIANA	LAS VEGAS, NEVADA	MARICOPA COUNTY, ARIZONA	OMAHA, NEBRASKA	PHOENIX, ARIZONA	SCRANTON, PENNSYLVANIA	TALLAHASSEE, FLORIDA	WILKES-BARRE, PENNSYLVANIA	WILLIAMSPORT, PENNSYLVANIA	
ACCOMMODATION BY LIFT:																		
WITNESS BOX			2	2			1	7										
JUDGE'S BENCH (NOW)			3	3			1	7					DISCON.					
JUDGE'S BENCH (FUTURE) (Y/N)		N																
JURY BOX (MECH. RAMP / LIFT) - R / L					L		R					R						
TYPE OF LIFT:																		
HYDRAULIC / SCISSORS																		1
CANTILEVERED WITH TOWER																		1
PORTABLE																		
INCLINED PLATFORM																		
OTHER																		
MANUFACTURER:																		
SOUTHFORK / T.L. SHIELD																		WB
NATIONAL WHEEL-O-VATOR																		
CONCORD																		JB
CUSTOM / LOCAL																		
OTHER										NOTE 1				NOTE 2				
GENERAL ISSUES:																		
HOW MANY LIFTS ARE AT THE FACILITY IN TOTAL:	1	4	5	5	2	1	2	14	2	10	1	9	11	2	1	1	2	
HOW LONG HAVE THEY BEEN IN OPERATION: (YRS)	1.5	3	2.5	2.5	U.C.		4	3	3	3	10	2	3	3	OUT	3	3 MOS.	
ARE THE LIFTS DEPENDABLE: (Y/N)	Y	N.U.	N.U.	Y	N.U.	N	Y	Y	Y	Y	N	N	Y	N	N	Y	Y	
ARE PEOPLE APREHENSIVE IN THEIR USE: (Y/N)					N.U.		N	N	Y	N	Y	Y	N			N	N/A	
OPERATIONAL ISSUES						Y						Y		Y				
MINIMAL USE ISSUES	Y	N.U.	Y	N							Y							
SERVICE REQUIRED SINCE INSTALLATION: (Y/N)										N						N	N/A	
PARTS																		
ADJUSTMENTS																		
HYDRAULICS																		
SERVICE / PARTS (LOCAL / REMOTE) (L/R)			R					R	R			R		L				
ARE PROBLEMS RELATED TO:																		
DESIGN																		
INSTALLATION																		
OPERATION / ADJUSTMENTS																		
GENERAL MAINTENANCE																		
ARE THERE ACOUSTIC / VIBRATION ISSUES: (Y/N)	Y	N	Y	N		Y	N	N	N	N		Y	N			N		
MINOR																		Y
MEDIUM																		
MAJOR																		

WHY NOT ALL WITH BOTH WITNESS BOX & JUDGE'S BENCH INITIALLY INSTALLED ?

HEIGHT LIMIT GUIDES & HYDRAULIC VALVES REPLACED

EXTENDED TIME AT SUSPENDED LEVEL RESULTS IN "SINKING"

REMOTE SERVICE & PARTS SUPPLY

NEED FOR STANDARD CONCEPTUAL ARRANGEMENT

MECHANICAL LIFT ANALYSIS

SUMMARY OF SURVEY & INTERVIEW RESPONSES, PLUS SITE OBSERVATIONS

(CONTINUED)

	BATON ROUGE, LOUISIANA	BROWNSVILLE, TEXAS	CORPUS CHRISTI, TEXAS	COVINGTON, KENTUCKY	DENVER, COLORADO	FARGO, NORTH DAKOTA	KANSAS CITY, MISSOURI	KNOXVILLE, TENNESSEE	LAFAYETTE, LOUISIANA	LAS VEGAS, NEVADA	MARICOPA COUNTY, ARIZONA	OMAHA, NEBRASKA	PHOENIX, ARIZONA	SCRANTON, PENNSYLVANIA	TALLAHASSEE, FLORIDA	WILKES-BARRE, PENNSYLVANIA	WILLIAMSPORT, PENNSYLVANIA	
LIFT PARKED POSITION:																		
LOWEST LEVEL							JB											
WITNESS BOX LEVEL (UP 1 STEP)							WB											
JUDGE'S BENCH LEVEL (UP 2 OR 3 STEPS)																		
ARCHITECTURAL COORDINATION ISSUES:																		
ARE THERE GAPS BETWEEN THE LIFT & ADJACENT FLOOR AREAS BEYOND 3/8" IN WIDTH: (Y/N)	Y	Y	N	N	U.C.	N	Y	Y	N	Y		Y	N	Y		N	N	
SERVICE ACCESSIBILITY:																		
ADJACENT TO UNIT																		
ADJACENT & REMOTE																		
PLATFORM EDGE & PIT EDGE FINISHES WELL DETAILED & EXECUTED: (Y/N)	Y	N	Y/N	Y/N	U.C.	Y	Y	Y	Y	N		N	Y	N		Y	Y	
MILLWORK @ GATES & ENCLOSURE WELL DETAILED & EXECUTED: (Y/N)	Y	NOT ENCL.	Y	Y	U.C.	Y	Y	Y	Y	Y		Y	N	Y		Y	Y	
CONTROLS LOCATION APPROPRIATE FOR EASY USE OF THE LIFT: (Y/N)				Y	Y		Y	N	Y	Y		Y	Y	Y		Y		
BARRIERS BETWEEN LEVELS (Y/N)																		
MECHANICAL DEVICES	Y	N				N	N/A	N/A	N/A	N			N/A				N/A	
MANUAL PLACEMENT												Y		Y				
NOT NEEDED																		
NOT PROVIDED BUT SHOULD HAVE BEEN																		
ELECTROMAGNETIC LATCH POSITIVE CONTACT PROBLEMS INTERFERING WITH OPERATION:																		
MINOR ISSUE					U.C.		N/A					N		N		N	N	
MODERATE ISSUE																		
MAJOR ISSUE																		

POTENTIAL "SINKING" PROBLEM (HYDRAULIC LIFTS)

ADEQUATE ARCHITECTURAL DETAILING IS NOT PROVIDED

NEED CRITERIA FOR PLACEMENT

ADEQUATE ARCHITECTURAL DETAILING IS NOT PROVIDED

NEED STANDARD DETAIL & DEVICE FOR THIS CONDITION

POSITIVE CONTACT AT GATE LATCH IS DIFFICULT

- R** JURY BOX RAMP IS MANUALLY PLACED AT PHOENIX & ELECTRICALLY CONTROLLED AT KNOXVILLE.
- JB** LIFT AT THE MARICOPA COUNTY COURTHOUSE WAS LOCATED IN THE BUILDING ENTRANCE CORRIDOR.
- WB** IDENTIFIES TYPE OF SYSTEM, WHERE IT IS LOCATED, MANUFACTURER, OR GENERAL ISSUE RELATED TO INSTALLATION.
- 1** SAME AS DARK BLUE INCLUDING ADDITIONAL REFERENCES IN TERMS OF GENERAL NOTATION, QUANTITIES, OR YES / NO RESPONSE.
- PROBLEM** PROBLEM WITH DESIGN, INSTALLATION, MAINTENANCE, OR OPERATION.
- GOOD** GOOD SOLUTION RELATED TO DESIGN AND / OR PERFORMANCE.
- NOTE 1** PORCH LIFT UNIT
- NOTE 2** ASCENSION PORTABLE LIFT UNIT
- U.C.** COURTHOUSE UNDER CONSTRUCTION
- N.U.** NOT USED

File: liftfm.j07

PROJECT / LOCATION:

RUSSELL B. LONG U.S. COURTHOUSE
BATON ROUGE, LOUISIANA

SITE VISIT (Y/N): **Y**

SURVEYS (SENT / RECEIVED): **2/2**

NUMBER OF LIFTS: **1**

TYPE OF LIFT: 1 **HYDRAULIC / SCISSORS**
 2

MANUFACTURER: **SOUTHWORTH /**
T.L.SHIELD

MODEL #: 1 **LS05-28**
 2

CAPACITY: **500 LB**

NUMBER OF LEVELS SERVICED: **1**

ACCOMMODATION: 1 **WITNESS BOX**
 2 **JUDGE'S BENCH**

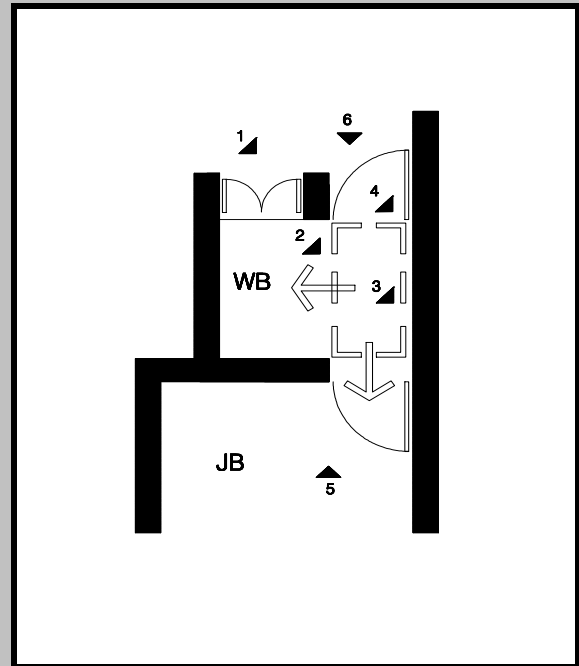

PLAN DIAGRAM AT LIFT LOCATION

CONSOLIDATED SURVEY & SITE VISIT INFORMATION:

A lift was installed in one courtroom as part of a renovation project completed approximately 1-1/2 years ago.

The lift system includes two retractable "blades", that act as wheel stops; one located on the edge of the platform facing the witness box, and the other at the edge of the witness box fixed floor facing the lift.

If the lift is at the lowest position, the blade at the elevated witness box floor is extended. When the lift moves up and past the witness box level, or is located at the Judge's bench, the blade on the lift platform is extended.

Ambulatory witnesses step up to the witness box at the riser located on the side of the box.

Problems exist relative to the electromagnetic locks on the gate latches. Positive contact is not always achieved without wiggling the gate back and forth, which leads to apprehension about use.

There is a 6" gap between the back wall of the courtroom and the lift platform when it is elevated because of projections in the wall surface.

The only service required on the lift system, since installation, has been for a minor leveling adjustment.

Exposed edges of the floor, adjacent to lift, have moldings and vertical surfaces extending into the lift pit and clad with wood veneer matching the millwork of the witness box and judge's bench.

Noise and vibration during lift operation is minimal.

There is some apprehension by Court personnel related to using the lift, but this can only be attributed to the infrequent use of the equipment, not because the lift is faulty.

1



Ambulatory Entrance To Witness Box

2

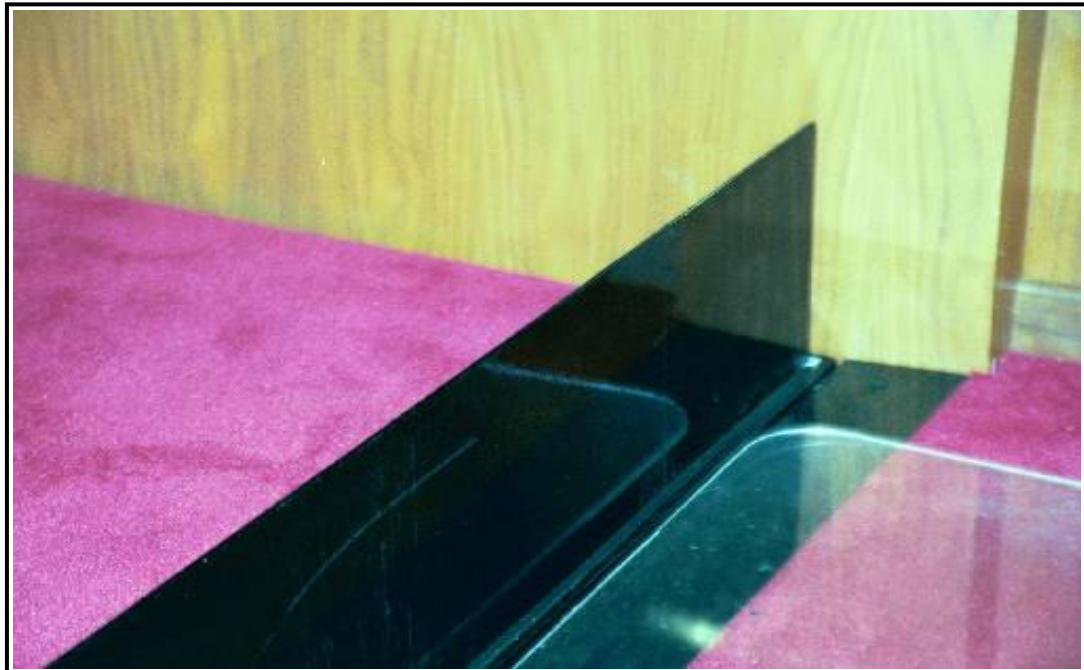

Wheel Stop Between Lift And Witness Box Floor

3



Lift Controls On Platform

4



Hinge At Gate Enclosing Lift

5



Access Panel To Lift Motor And Electrical Control Panel At Judge's Bench Floor

6



Lift Frame And Hydraulic Cylinders

File: liftfm.j07

PROJECT / LOCATION:

U.S. COURTHOUSE
BROWNSVILLE, TEXAS

SITE VISIT (Y/N):

SURVEYS (SENT / RECEIVED):

NUMBER OF LIFTS:

TYPE OF LIFT: 1
 2

MANUFACTURER:

MODEL #: 1
 2

CAPACITY:

NUMBER OF LEVELS SERVICED:

ACCOMMODATION: 1
 2

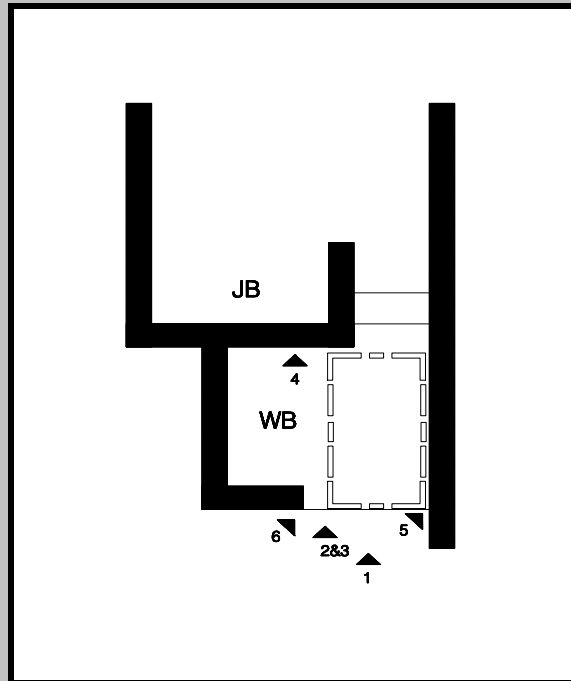

PLAN DIAGRAM AT LIFT LOCATIONS

CONSOLIDATED SURVEY & SITE VISIT INFORMATION:

The four lifts are all designed as an open section of the witness box level located one riser up from the courtroom well floor level. *A gated perimeter enclosure is not provided.* Motorized wheel stops are included at only one of the lift installations.

It would be very difficult to adapt these lifts to future accommodation of the Judge's bench because no gated enclosures are provided.

Large gaps (1" to 2" in width) occur along the perimeter of the lift and the adjacent floor plus wall surfaces. (Detailing and execution of the finishes at these locations is also marginal.)

Leveling between landings and the lift platform is not maintained; and with no perimeter enclosure around the platform, this becomes a significant tripping hazard.

There has been some concern expressed regarding the difficulty in service provision and related coordination with the supplier / installer.

The electrical panel and motor for the lift operation are located in the electrical closet behind the courtroom eliminating a need for a service access panel in the floor at the judge's bench.

1



Typical Installation

2



Wood Riser Removed For Service Access

3

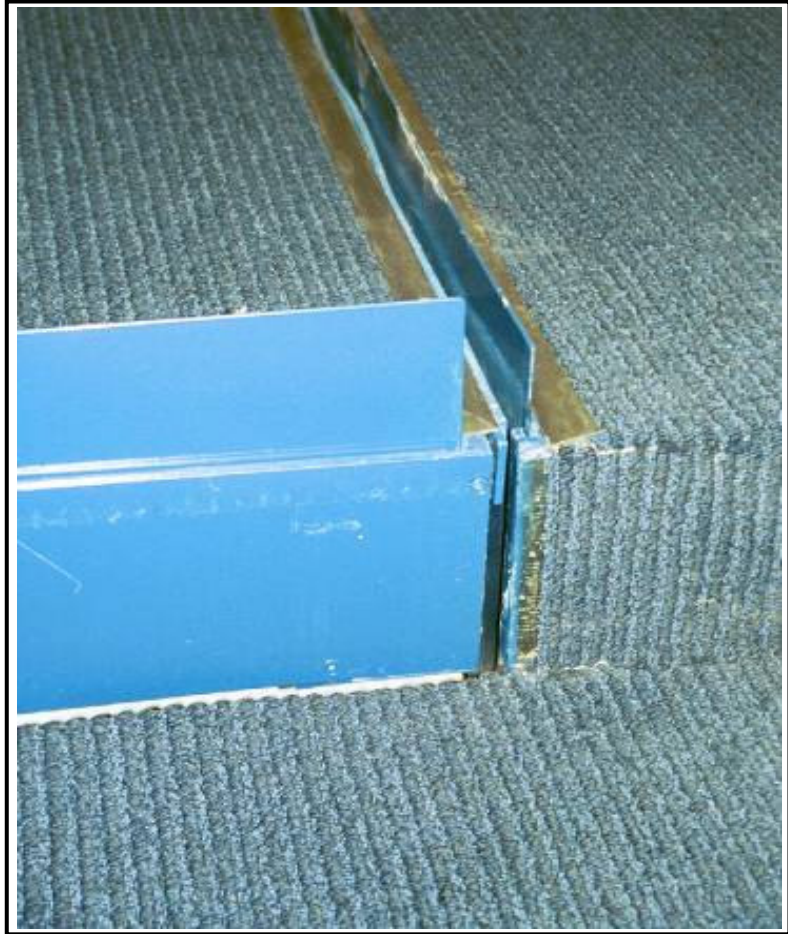

Motorized Wheel Stops At Second Courtroom

4



Instructional Plaque

5



Horizontal And Vertical Gaps

6

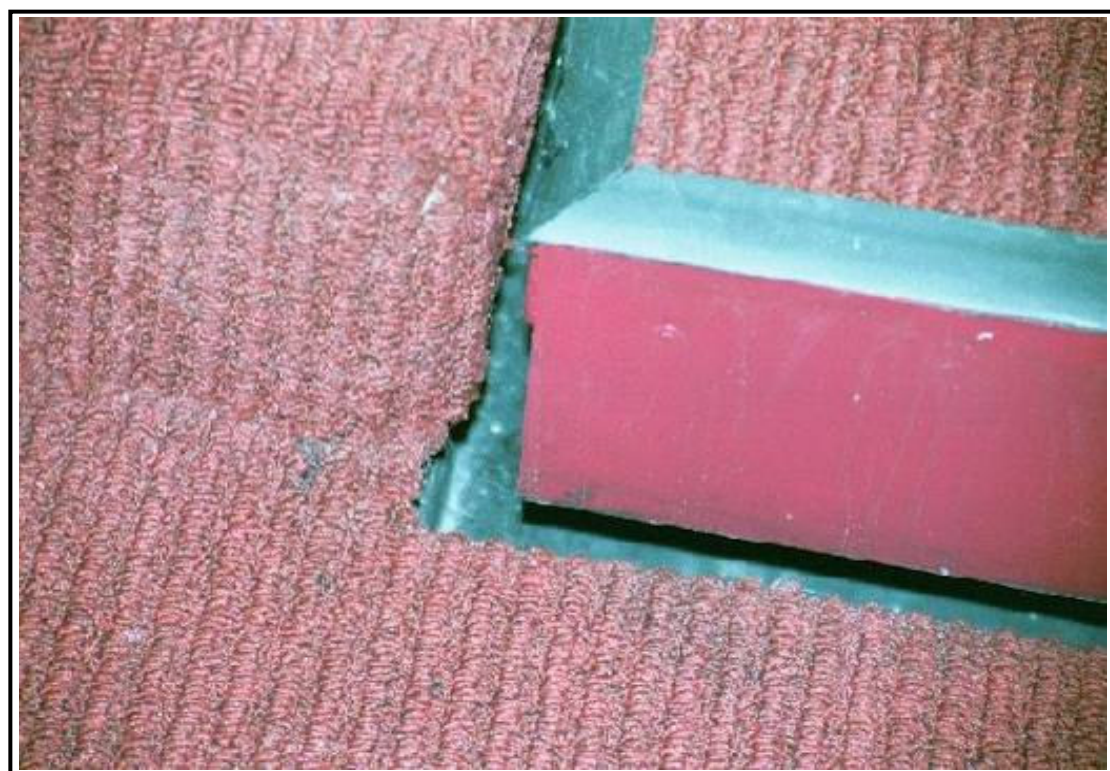

Two Inch Gaps At Perimeter

File: liftfm.j07

PROJECT / LOCATION:

U.S. COURTHOUSE
CORPUS CHRISTI, TEXAS

SITE VISIT (Y/N): **Y**

SURVEYS (SENT / RECEIVED): **4/3**

NUMBER OF LIFTS: **5**

TYPE OF LIFT: 1 **HYDRAULIC / SCISSORS**
 2

MANUFACTURER: **SOUTHWORTH /**
T.L.SHIELD

MODEL #: 1 **LS05-28**
 2

CAPACITY: **500 LB**

NUMBER OF LEVELS SERVICED:

ACCOMMODATION: 1 **WITNESS BOX (2 LIFTS)**
 2 **WITNESS BOX + JUDGE'S BENCH (3 LIFTS)**

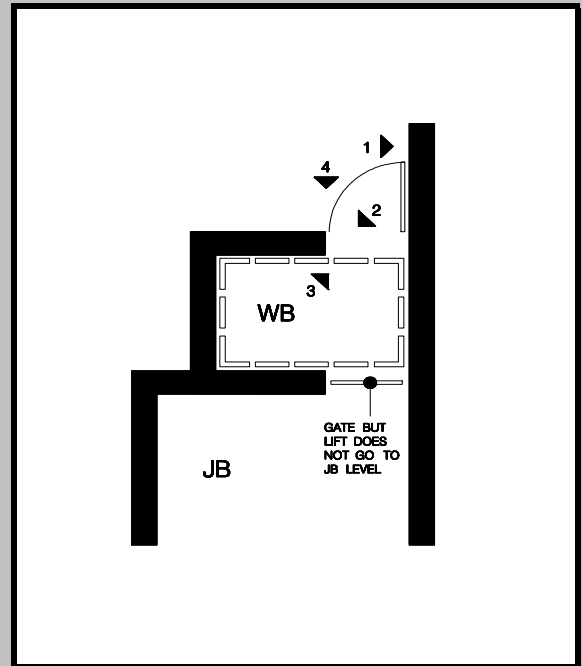

PLAN DIAGRAM AT LIFT LOCATIONS

CONSOLIDATED SURVEY & SITE VISIT INFORMATION:

The lifts are normally located at an elevated height equivalent to one riser. The riser element attached to the lift platform is a flexible vinyl strip that can be a tripping hazard. (A solid step element should be placed at the edge of the raised lift to eliminate this problem.)

All lifts are the full dimensions of the witness box.

The solenoid valve needed replacement after 2 months, along with hydraulic seals. (Sinking due to reduction of hydraulic pressure did occur.)

The abrupt movement was the only concern related to operation.

The 5-year warrantee, allowing 30 days to accomplish repair work, was amended to "5 working days to complete repairs."

A steel bar was provided to hold the scissors lift in the highest elevated position for servicing; but there is not enough space to place the bar in the frame as intended.

Minor noise and vibration, plus some binding occurs during operation. (The binding could be due to mis-alignment of the lift within the pit, or not enough clearance in the dimensions of the opening.)

The electrical panel and lift motor are located in the electrical closet on the side of the courtroom.

Local service for the lifts is provided.

The operator and maintenance representatives questioned the need for key operation. (It is more of an inconvenience rather than a security control issue.)

1

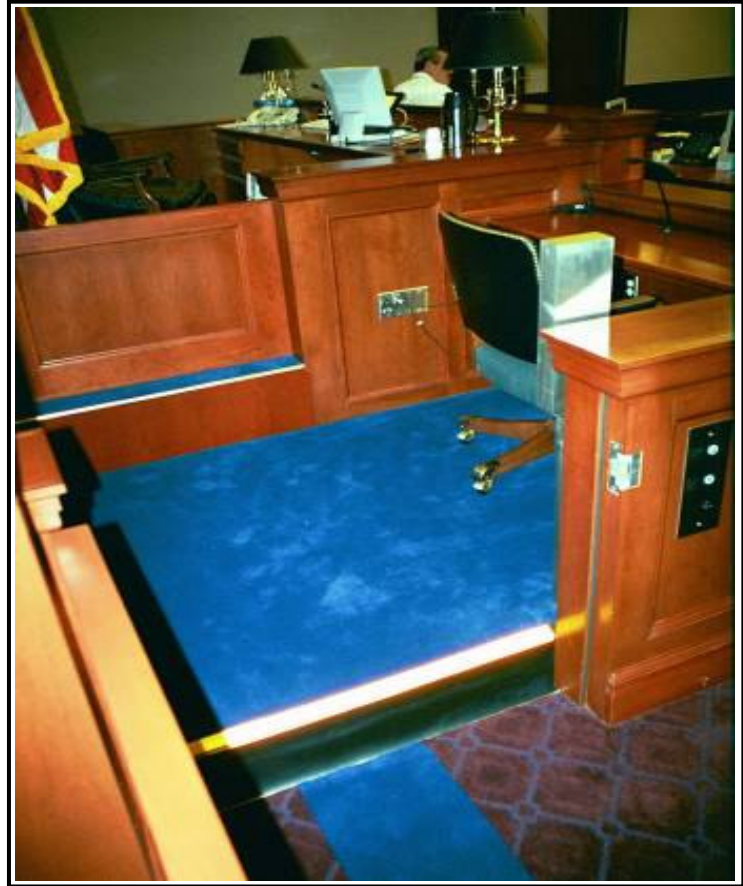

Ambulatory Entrance To Witness Box

2

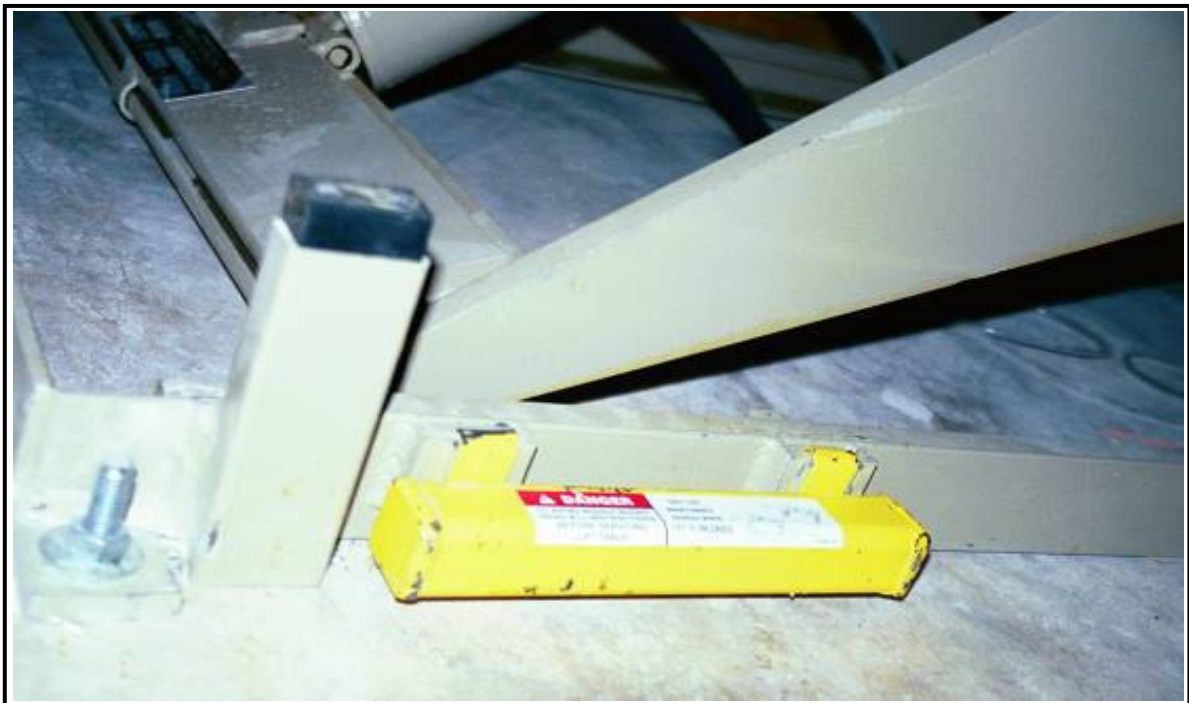

Bar To Secure Lift In Raised Position For Servicing

3



Lift Controls On Platform

4



Platform Framing And Scissors Lift Mechanism

File: liftfm.j07

PROJECT / LOCATION:

U.S. COURTHOUSE
COVINGTON, KENTUCKY

SITE VISIT (Y/N): **Y**

SURVEYS (SENT / RECEIVED): **3/2**

NUMBER OF LIFTS:

TYPE OF LIFT: 1 **HYDRAULIC / SCISSORS**
 2

MANUFACTURER: **SOUTHWORTH /**
T.L. SHIELD

MODEL #: 1 **LS05-28**
 2

CAPACITY: **500 LB**

NUMBER OF LEVELS SERVICED: **(BELOW)**

ACCOMMODATION: 1 **WITNESS BOX (2 LIFTS)**
 2 **WITNESS BOX + JUDGES BENCH (3 LIFTS)**

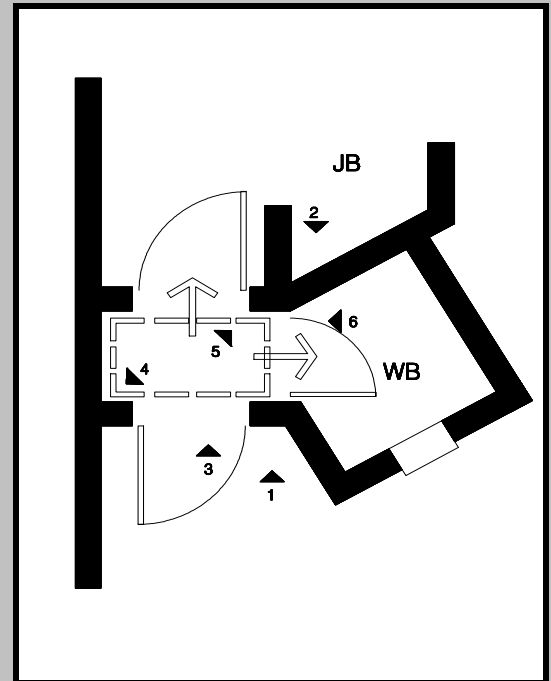

PLAN DIAGRAM AT LIFT LOCATIONS

CONSOLIDATED SURVEY & SITE VISIT INFORMATION:

There have been settlement problems when the lift platform remained at an elevated position over an extended period of time.

Frayed cables were the only maintenance issue to date.

Operating controls in the lift enclosure are mounted in the wall and are marginal in meeting the height limits of code in the raised position.

Service and parts must come from California.

The gaps between the lift platform and the enclosure exceed 1" on average.

1



Independent Ambulatory And Accessible Means To The Witness Box

2



Gate At Judge's Bench

3

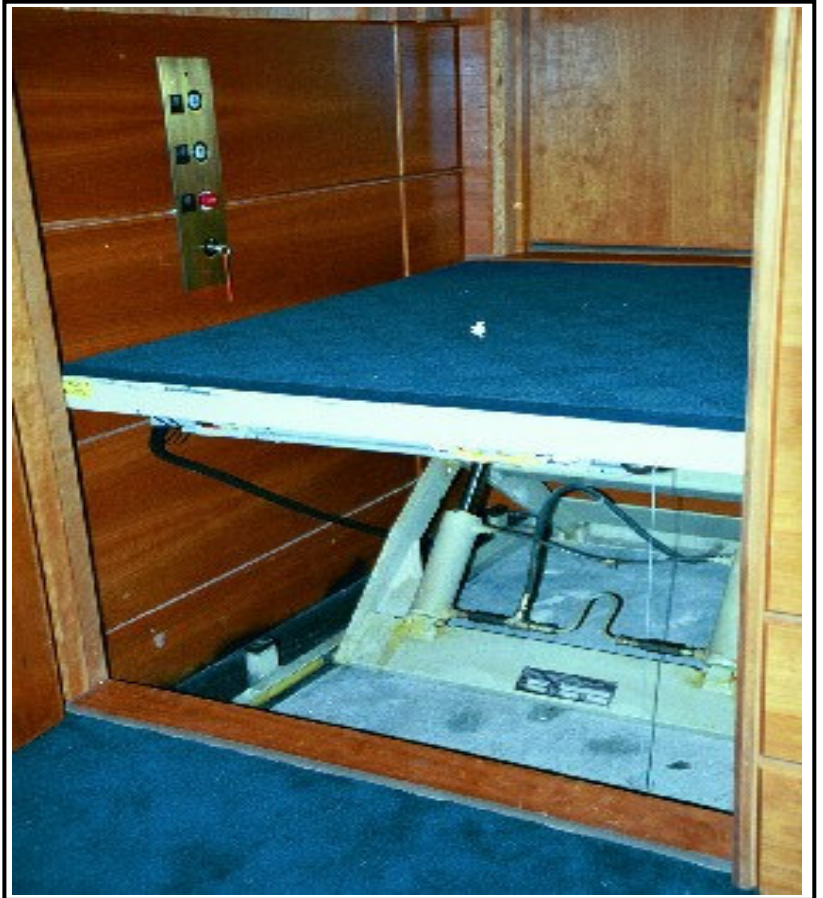

Controls Too Low At Elevated Lift Position

4



Large Gap Between Lift At Enclosure

5



Gate At Judge's Bench & Witness Box

6



Controls At Courtroom Well Level

File: liftfm.j07

PROJECT / LOCATION:

ALFRED A. ARRAJ U.S. COURTHOUSE
DENVER, COLORADO

SITE VISIT (Y/N): **Y**

SURVEYS (SENT / RECEIVED): **1/0**

NUMBER OF LIFTS: **2**

TYPE OF LIFT:
 1 **CANTILEVERED PLATFORM**
 2

MANUFACTURER:
NATIONAL
WHEEL-O-VATOR

MODEL #:
 1 **BC-42**
 2

CAPACITY: **700 LB**

NUMBER OF LEVELS SERVICED: **2**

ACCOMMODATION:
 1 **JURY BOX**
 2 **JUDGE'S BENCH**

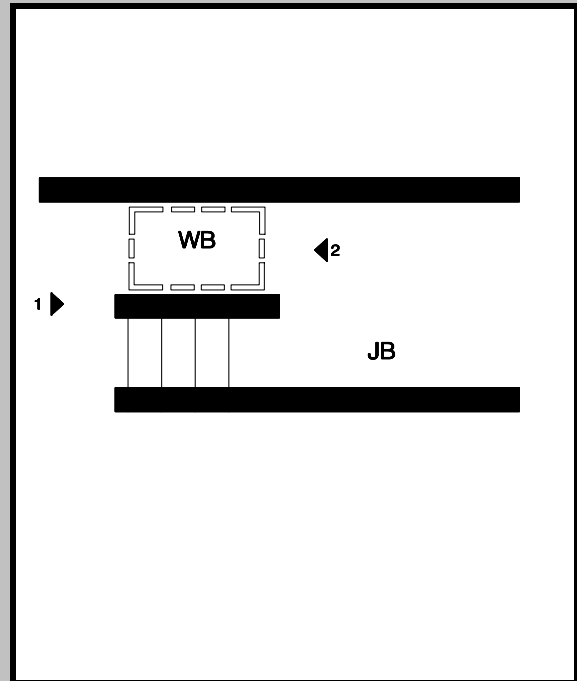

PLAN DIAGRAM AT JUDGE'S BENCH LIFT

CONSOLIDATED SURVEY & SITE VISIT INFORMATION:

This facility is currently under construction and offers a unique perspective that includes the actual installation of the lift.

There are two independent lifts in the Special Proceedings Courtroom for the jury box and the judge's bench. (The witness box is accessed by a short ramp.) Typical courtrooms have future provisions for lifts.

The tower element, which contains the Acme screw drive mechanism for the lift, is placed behind wood paneling well integrated into the lift enclosure at both conditions.

No protection is currently provided on the end of the lift platform at the jury box to prevent a wheelchair from rolling off the edge. (It is possible, given the fact that the installation is not complete, that some sort of raised/retractable edge protection remains to be installed to prevent a wheelchair from falling off the platform.)

It appears that the jury box lift will be in the raised position for ambulatory jurors. (This will not cause the "sinking" of the platform level over time, common to hydraulic units, because of the stability of the Acme screw drive.)

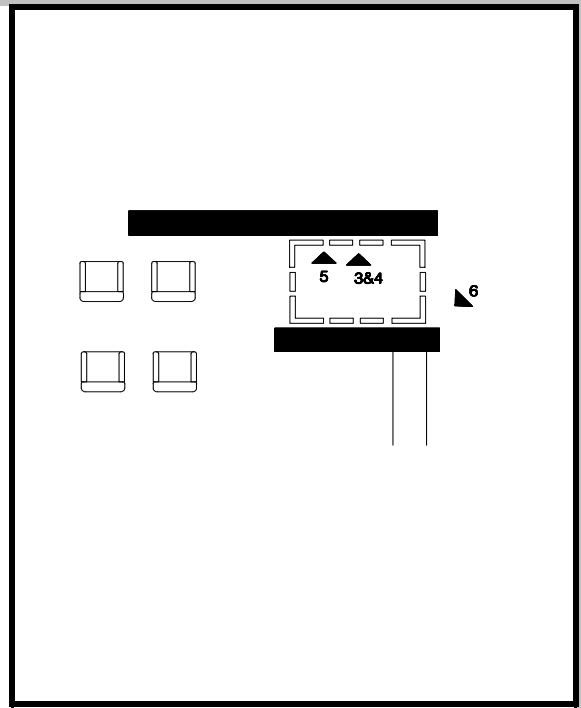

PLAN DIAGRAM AT JURY BOX LIFT

1



Lift And Ambulatory Access To Judge's Bench

2



Looking From Judge's Bench Into Lift Enclosure

3



Acme Screw Drive Recessed Into Millwork Enclosure

4

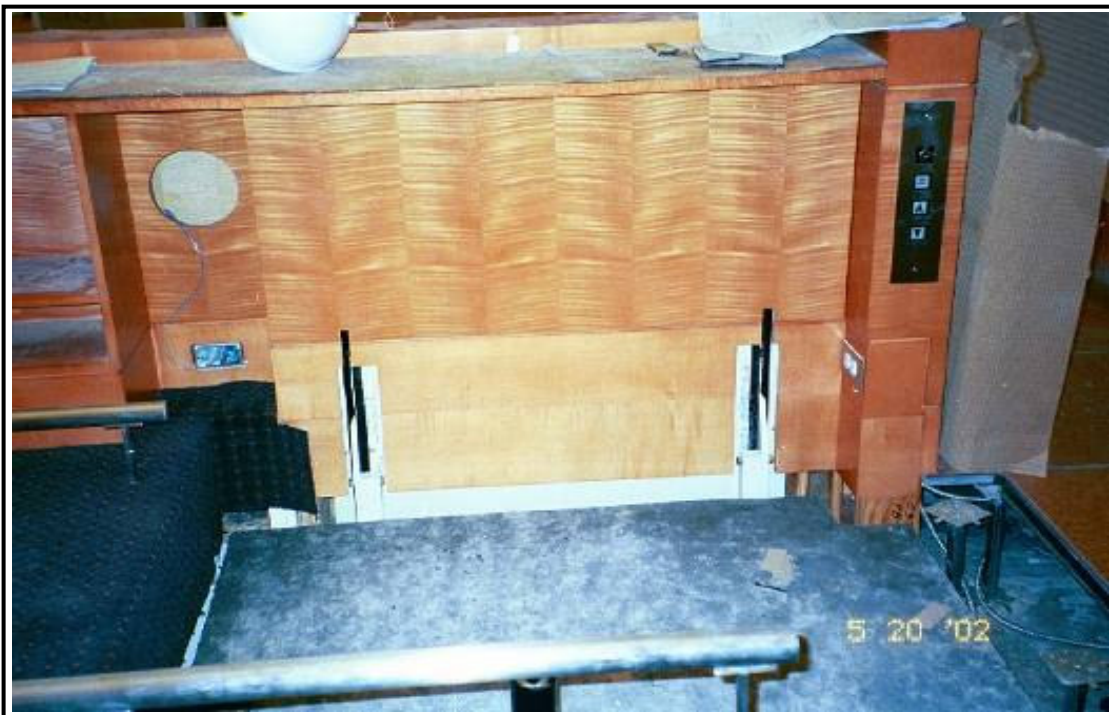

Upper Enclosure Panel Incorporated Into Millwork

5



Carriage Frame Protruding Through Enclosure

6



Jury Box Unit At Courtroom Well Level

File: liftfm.j07

PROJECT / LOCATION:

QUENTIN N. BURDICK COURTHOUSE
FARGO, NORTH DAKOTA

SITE VISIT (Y/N): **Y**

SURVEYS (SENT / RECEIVED): **3/2**

NUMBER OF LIFTS: **1**

TYPE OF LIFT: 1 **HYDRAULIC / SCISSORS**
 2 **T.L. SHIELD**

MANUFACTURER: **LS05-28**

MODEL #: 1
 2

CAPACITY: **500 LB**

NUMBER OF LEVELS SERVICED: **1**

ACCOMMODATION: 1 **WITNESS BOX**
 2

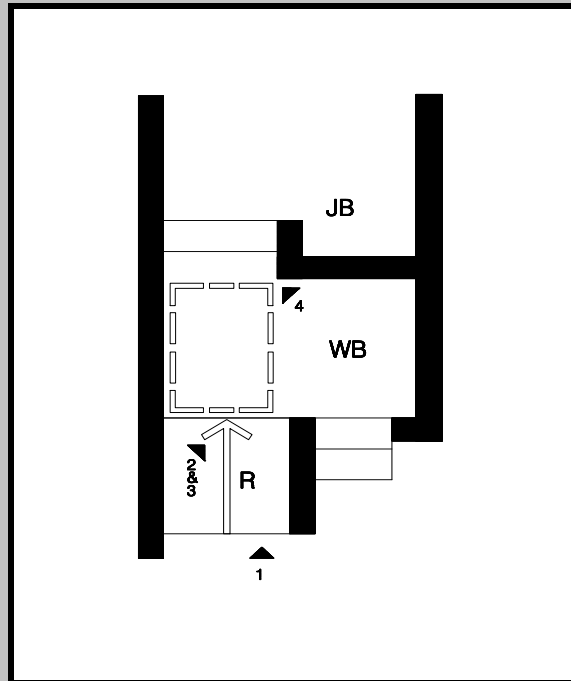

PLAN DIAGRAM AT LIFT LOCATION

CONSOLIDATED SURVEY & SITE VISIT INFORMATION:

Originally lifts were installed in three courtrooms and presently one courtroom retains an operating lift.

Courtroom 1: The lift is still in place, and according to the GSA Building Manager, it is never used. A door in the corner of the courtroom provides access to an enclosed hallway and the approach ramp. The door must be operated by a bailiff. The first set of lift controls is located at the bottom of the approach ramp, just inside the door, and must also be operated by a bailiff with a key. The second set of lift controls is located at the top of the approach ramp, adjacent to the lift platform, and also requires a key.

Although the lift mechanism is relatively quiet during operation, the judge is dissatisfied by the sharp clunk and/or squeak that results when the lift platform is stepped on while being raised or lowered.

Courtroom 2: This lift was removed because "the judge didn't like it." Apparently, the lift was inconvenient to use, and the appearance of the gate was objectionable. The original location of the lift entry has been cordoned off and the controls removed.

1



Approaching Ramp And Lift To Witness Box

2



Lift At Lowest Level

3



Wheel Stop Raised

4



View From Witness Box With Lowered Lift

File: liftfm.j07

PROJECT / LOCATION:

CHARLES EVANS WHITAKER U.S. COURTHOUSE
KANSAS CITY, MISSOURI

SITE VISIT (Y/N):

SURVEYS (SENT / RECEIVED):

NUMBER OF LIFTS:

TYPE OF LIFT:
 1 **HYDRAULIC / SCISSORS**
 2

MANUFACTURER:
SOUTHWORTH /
T.L. SHIELD

MODEL #:
 1
 2

CAPACITY:

NUMBER OF LEVELS SERVICED:

ACCOMMODATION:
 1 **WITNESS BOX (3)**
 2 **JUDGE'S BENCH (1)**

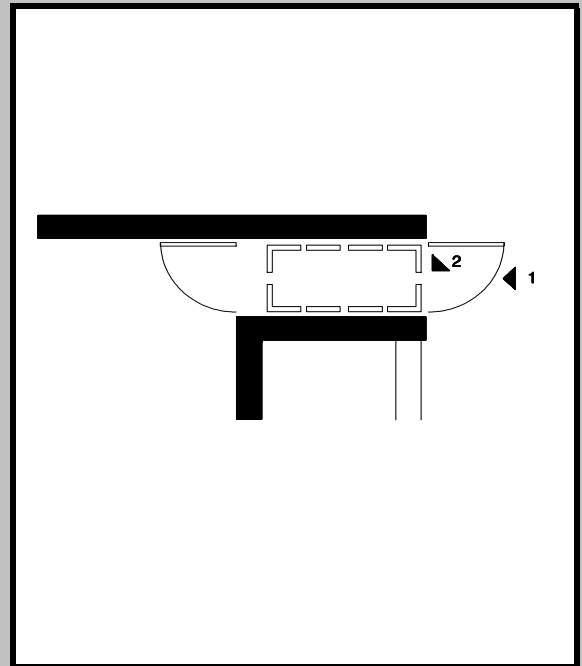

PLAN DIAGRAM AT LIFT LOCATIONS (WITNESS BOX)

CONSOLIDATED SURVEY & SITE VISIT INFORMATION:

Despite the slightly irregular shape of the platform, the movement of the platform does not result in a sense of instability or vibration.

The gate interlocks required servicing within one year of operation.

The primary concern from the user is that removal of the temporary access stairs from either the witness box or judge's bench lifts is difficult and cumbersome due to the weight of the steps and snug fit within the millwork opening.

Audible noise during lift operation was minimal with only a slight "clunk" noted when the lift platform is fully retracted, stopping in the scissors lift sub-frame. (The Mechanical "clunk" could undoubtedly be eliminated with the addition of a rubber isolation pad on the frame.)

Margins within standards between lift platform and millwork were consistent due in large part to care during installation of lift platform and adjacent floor and millwork structures. This included not only the clearances between the rectangular shaped lift platform at the judge's bench but also the trapezoidal shaped lift platform comprising the floor of the witness box.



Stair On Platform (Judge's Bench)

2

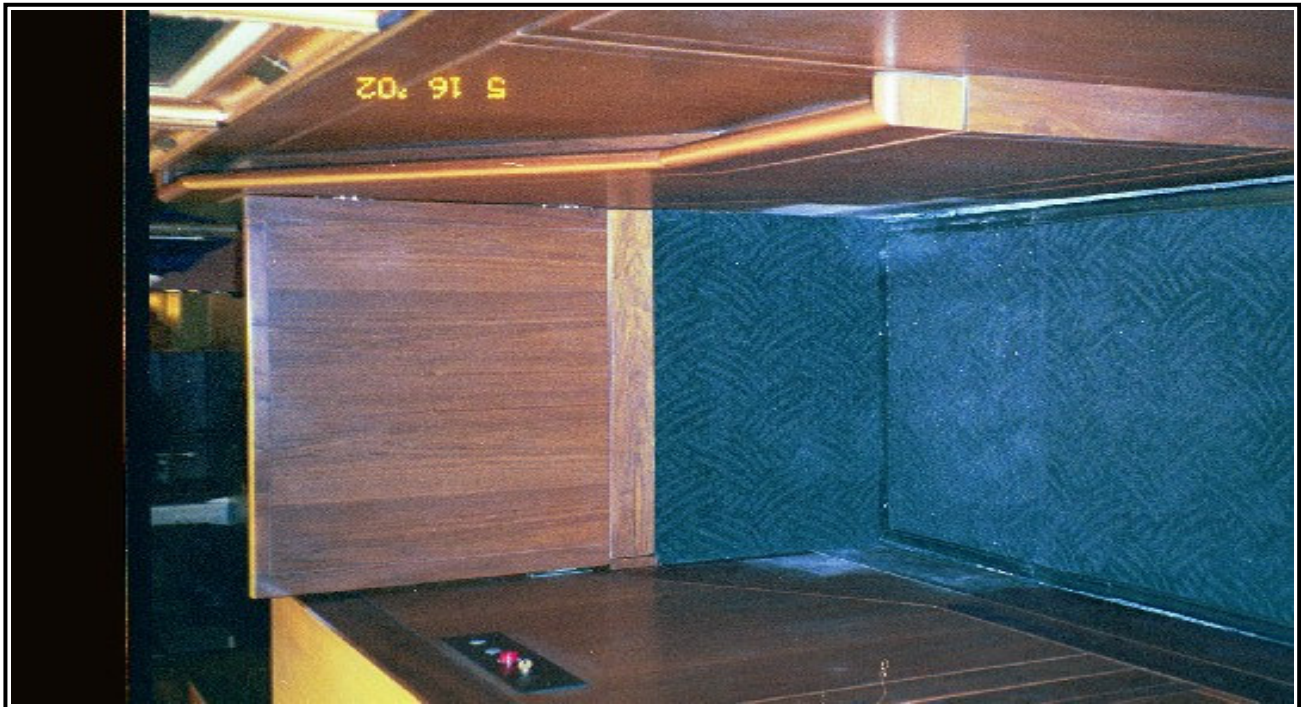

Stair Element Removed (Judge's Bench)

1

3

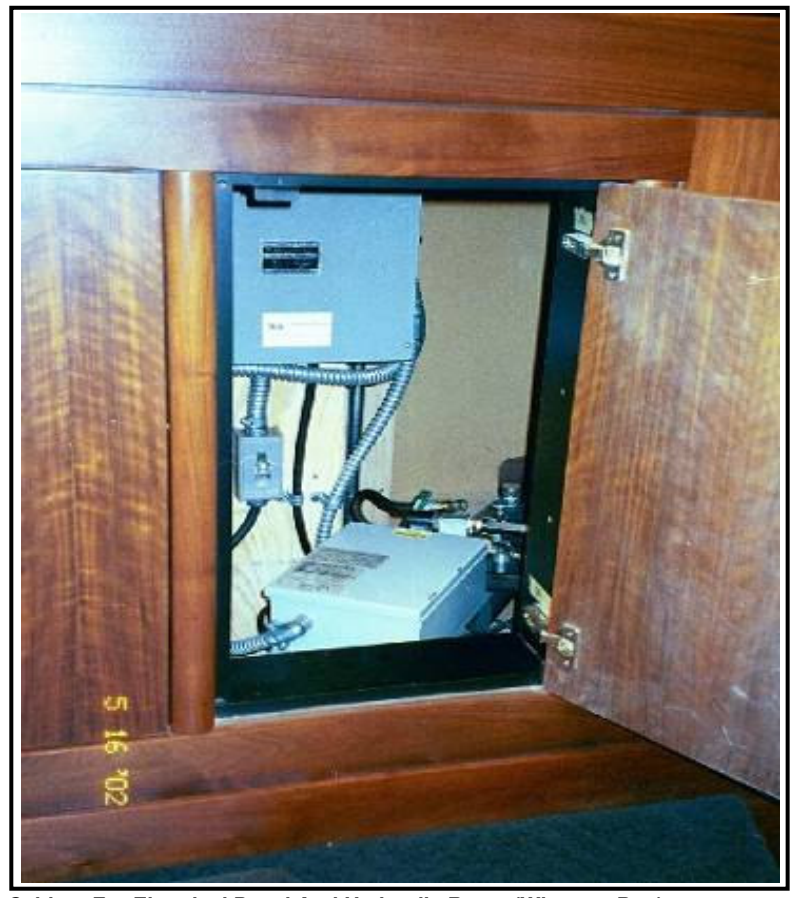

Cabinet For Electrical Panel And Hydraulic Ramp (Witness Box)

4



Millwork Enclosure (Judges' Bench)

5



Stair Element (Witness Box)

6



Millwork With Concealed Equipment (Witness Box)

7



Height Limiting Cable

8



Hydraulic Cylinder/Lines And Scissors Pivot Elements

File: liftfm.j07

PROJECT / LOCATION:

HOWARD BAKER, JR. U.S. COURTHOUSE
KNOXVILLE, TENNESSEE

SITE VISIT (Y/N): **Y**

SURVEYS (SENT / RECEIVED): **3/2**

NUMBER OF LIFTS:

TYPE OF LIFT: **1 HYDRAULIC / SCISSORS**

TYPE OF RAMP: **2 ELECTRIC / ROLLER**

MANUFACTURER: **T.L.SHIELD**

MODEL #: **1**
2

CAPACITY: **500 LB**

NUMBER OF LEVELS SERVICED: **2**

ACCOMMODATION: **1 WITNESS BOX**
2 JUDGE'S BENCH

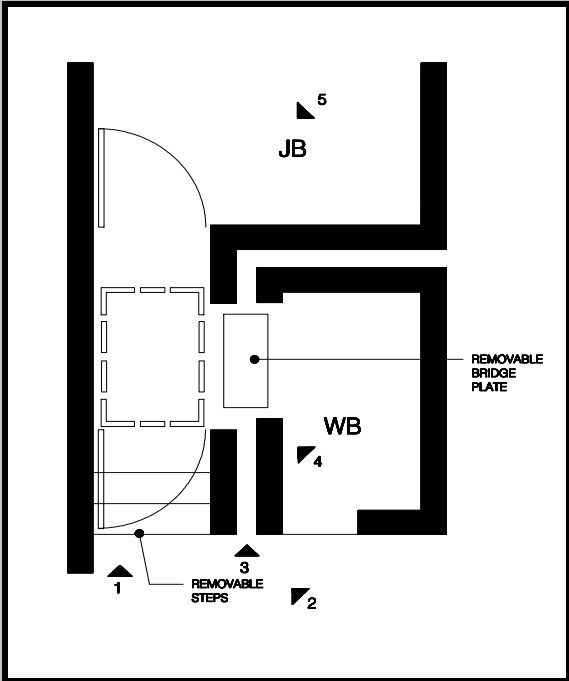

PLAN DIAGRAM AT LIFT LOCATIONS (WITNESS BOX / JUDGE'S BENCH)

CONSOLIDATED SURVEY & SITE VISIT INFORMATION:

The witness box at one courtroom was entirely independent of the lift enclosure and the judge's bench. (It appeared that the intent may have been to allow flexibility in its location, but the size and no evidence of rollers for movement, made it nearly impossible to relocate.) The double millwork half walls, each with a separate gate, between the lift platform and the witness box made it very difficult to adapt for accessible requirements. A small metal plate was installed between the lift platform edge and the witness box, bridging an 8" gap.

A pair of removable risers are placed at the lift, in an elevated position, when accessibility to the physically disabled is not an issue.

The lift was stable and displayed minimum noise and vibration.

A witness box at another courtroom was located away from the judge's bench, facing perpendicular to it. This installation included a 3 FT x 5 FT cabinet for equipment location. Only 10 percent of the cabinet was occupied by lift equipment and the remainder was reserved for other future systems components.

This facility has mechanical ramps for the jury boxes. They are electric powered and project from retract into space under the elevated platform. The hinged riser concealing the ramp automatically

opens and closes with the movement of the ramp over rollers.

The access way to the electric panel and the hydraulic motor in one installation was concealed under carpet at the judge's bench, which was impossible to lift without delaminating a corner of the carpet to pry open the plywood panel.

Operations personnel noted that there were electromagnetic contact problems at the gate latch. They also expressed a concern about slow response from the installer related to punch list and construction project closeout issues.

*Photo 9&10 are taken of independent witness box

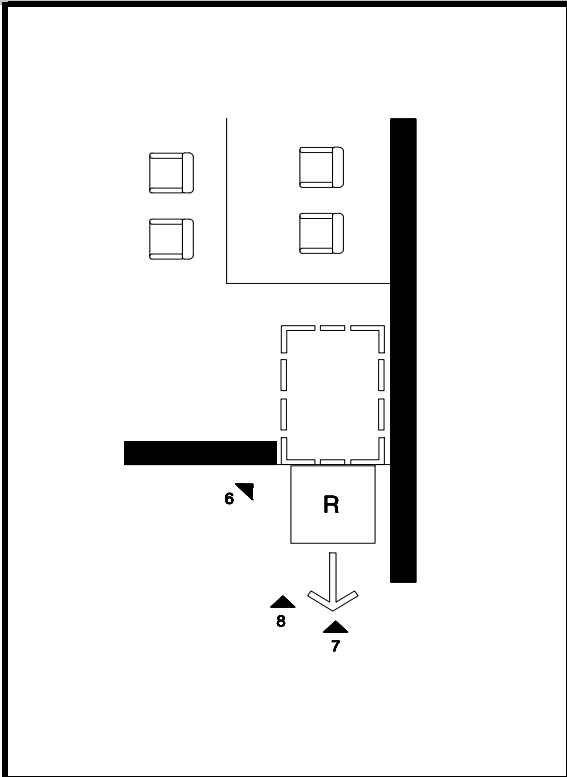

PLAN DIAGRAM AT LIFT LOCATIONS (JURY BOX)

1



Removable Steps At Lift

2



Millwork At Lift And Witness Box

3



Gap Between Lift Area And Witness Box

4

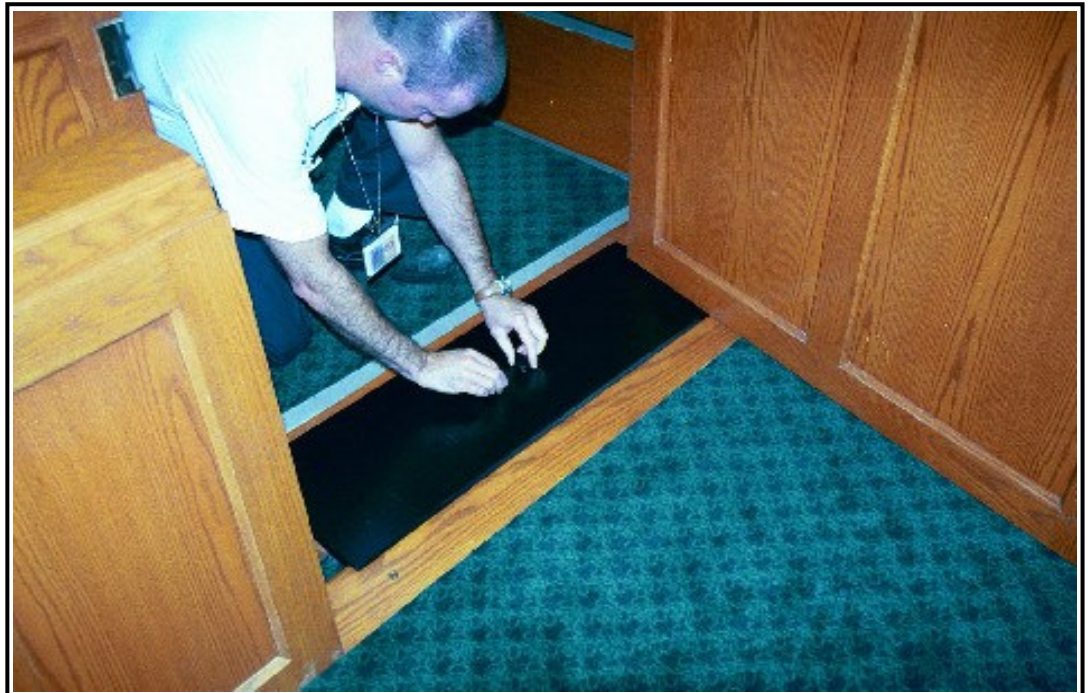

Metal Plate To Bridge The Gap

5

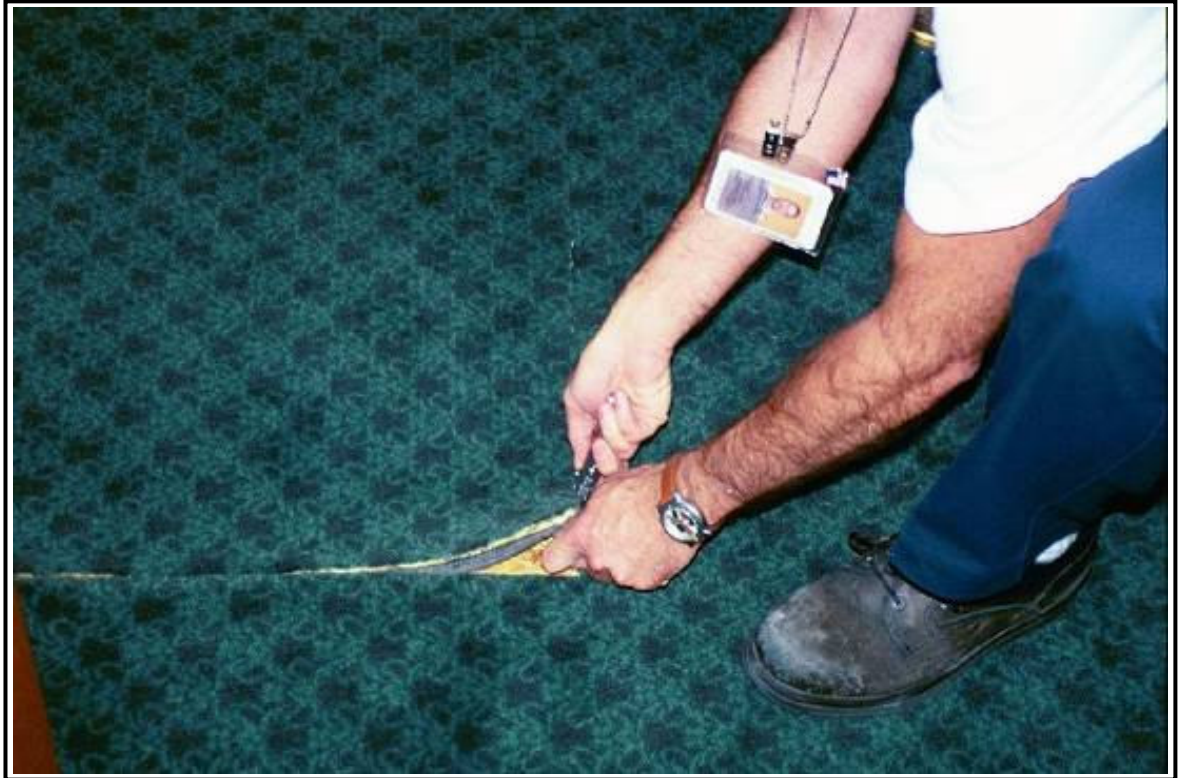

Pulling Up Carpet To Reach Access Panel

6



Retractable Ramp Stored Under Jury Box

7



Fully Extended Ramp At Jury Box

8

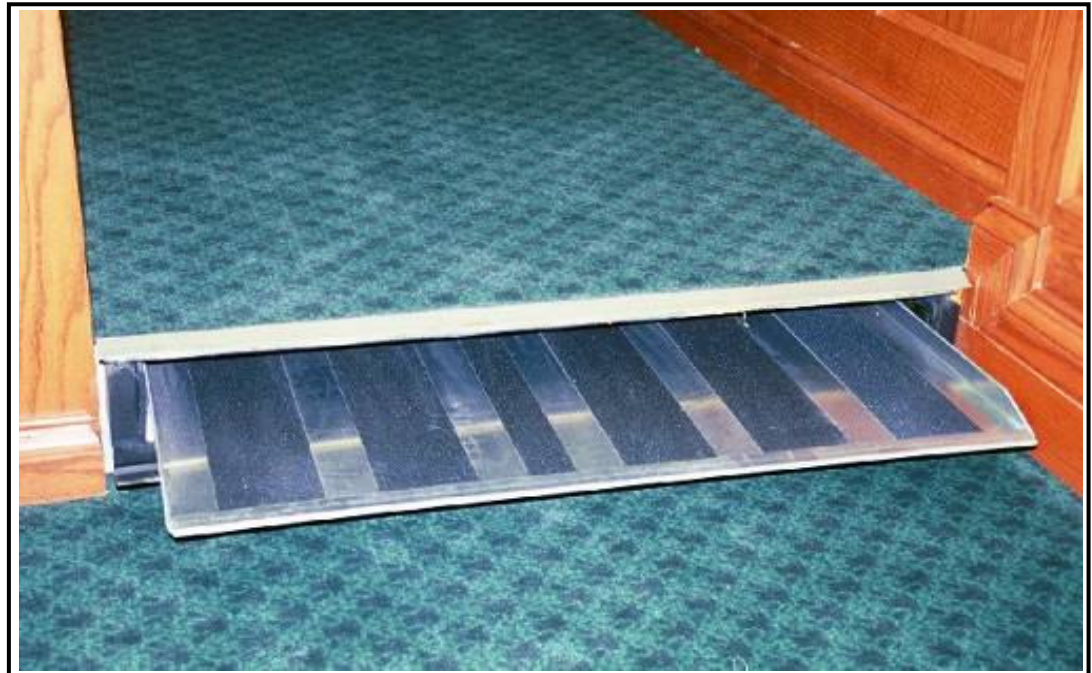

Ramp Being Extended From Under Jury Box

9

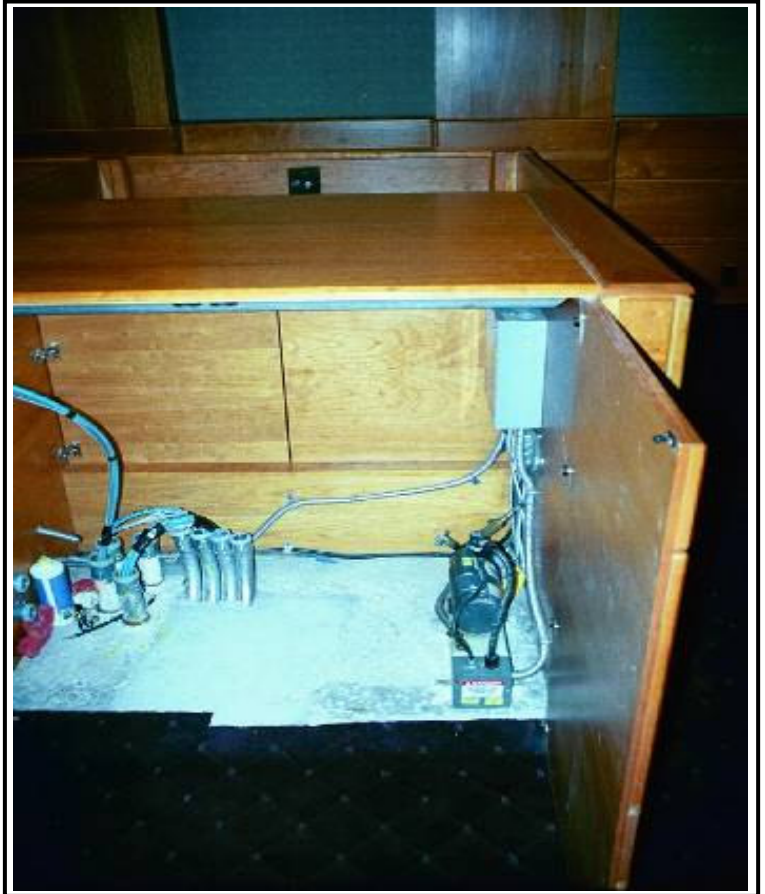

Equipment Storage Cabinet At Independent Witness Box

10



Independent Jury Box With Lift

File: liftfm.j07

PROJECT / LOCATION:

JOHN M. SHAW U.S. COURTHOUSE
LAFAYETTE, LOUISIANA

SITE VISIT (Y/N): **Y**

SURVEYS (SENT / RECEIVED): **6/4**

NUMBER OF LIFTS: **2**

TYPE OF LIFT: 1 **HYDRAULIC / SCISSORS**
 2

MANUFACTURER: **SOUTHWORTH /**
T.L.SHIELD

MODEL #: 1 **LS05-30**
 2

CAPACITY: **500 LB**

NUMBER OF LEVELS SERVICED: **1**

ACCOMMODATION: 1 **WITNESS BOX**
 2

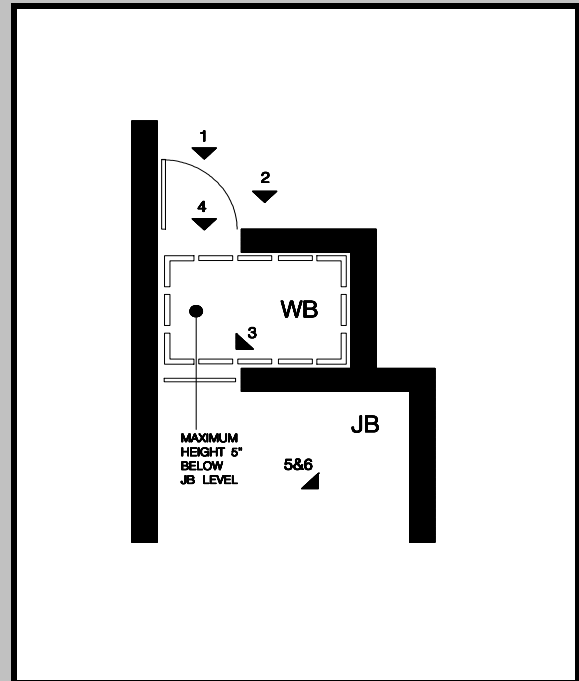

PLAN DIAGRAM AT LIFT LOCATIONS

CONSOLIDATED SURVEY & SITE VISIT INFORMATION:

The lift platform is actually the entire witness box floor and currently it can only be raised above the witness box level to within 5 IN of the judge's bench level. (The limit switch would need to be changed, plus the related cable mechanism lengthened in order to reach the judge's bench.)

A gate is provided at the judge's bench to access the lift platform. When the lifts are at the highest position (5 IN lower than the judge's bench) the gate at that level unlocks, which indicates an intent to access the judge's bench as part of the original design. It appears that there may have been a coordination problem between the specifications, performance criteria, and shop drawing approval process since the only issues that do not allow direct access to the judge's bench are the limit switch and cable length.

The main concern from both maintenance staff and those that operate the lift are the difficulties with the electromagnetic latch system. If the latch does not have total electromagnetic contact, the lift won't operate because there is only a small amount of tolerance in the system. (The gate needs to be jiggled until there is positive contact.) At this facility, and many others with similar installations, this issue has led to concerns by the operators about dependability.

When the lifts were first utilized, the latch solenoid overheated. (It was repaired by enlarging the lock cavity in the jamb to provide more air space.) In addition, the cable, which restricts the vertical movement of the lift, would initially jump the track until additional lubrication was provided.

Service for the lifts at this location is only provided from the manufacturer's headquarters in California.

The lifts have been installed for three years. Building maintenance receives a schedule on each Friday for courtroom use during the following week. (If it is anticipated that lift operation will be required, it will be highlighted on the court schedule.) The lifts are then tested prior to use.

Key control of the lift operation can provide some challenges, and it was questioned whether a keyed operation is really necessary. (Typically the building manager and the Clerk of Courts retain a key, but there is a potential situation that no key will be available when the lift operation is required.)

When this lift is not in operation, which is more than 95 percent of the time, the witness box floor level is in the suspended position (one step up from the courtroom well floor level.) The hydraulic system is in operation, under pressure, all of this time. It is apparent that loss of pressure within the hydraulic system will be more prevalent because of this condition. It would be more practical to provide retractable struts that would sustain the pressure at the suspended position and allow hydraulic pressure to be released for the non-operational period.

Gaps between the lift platform and adjacent fixed floor level edges are less than 3/4 IN.

Removable stairs (two risers) are used when accessibility for the disabled is not an issue. (The stair element is heavy and awkward to remove.)

Vibration and equipment noise are noticeable, but not of a high magnitude. Stability is not an issue.

A metal edge molding is used around the perimeter of the platform; and carpet at the fixed floor level edges is turned down into the pit.

Gates are well integrated into the millwork of both the witness box and judge's bench.

1



View Into Witness Box - Lift At Lowest Level

2



Lift At Witness Box Level / Controls / Exposed Mechanism

3

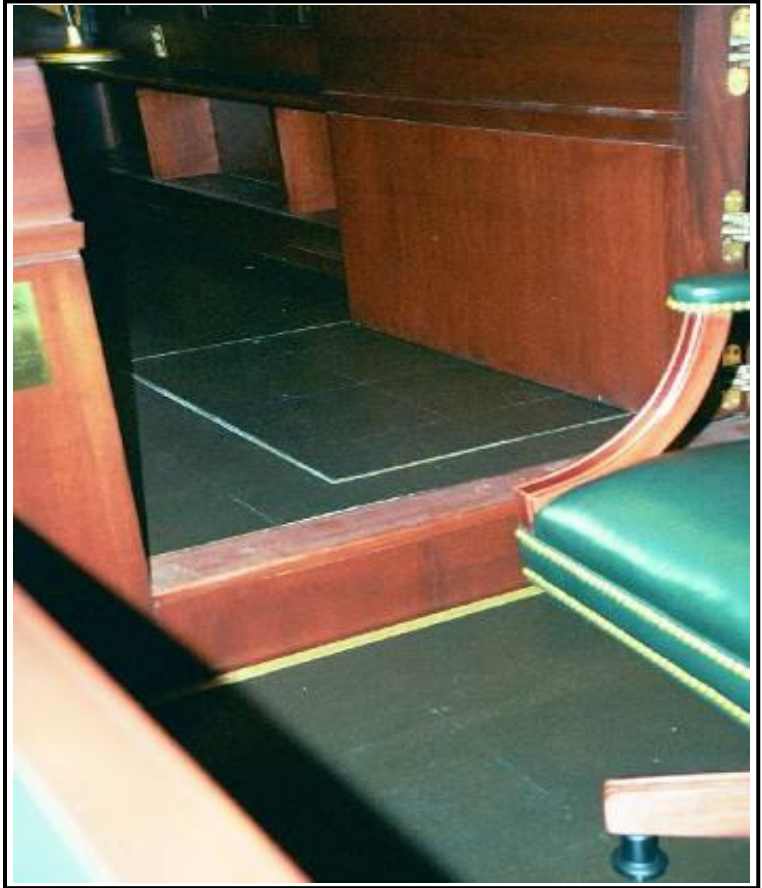

Access Panel To Service Electrical Panel And Hydraulic Pump

4



Lift Scissors Supports And Frame
(Note: Lifting Cable Fully Extended)

5

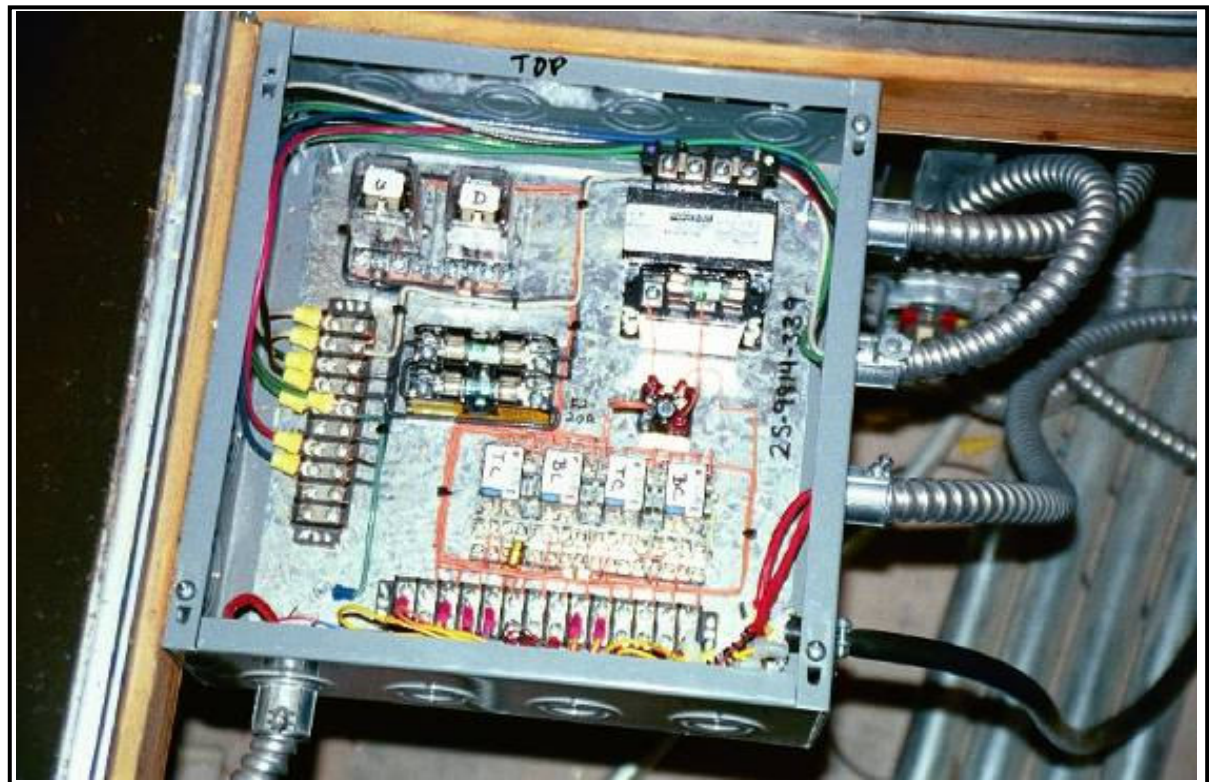

System Electrical Panel

6



Access Area With Electrical Panel And Hydraulic Pump

File: liftfm.j07

PROJECT / LOCATION:

LLOYD D. GEORGE U.S. COURTHOUSE
LAS VEGAS, NEVADA

SITE VISIT (Y/N): **Y**

SURVEYS (SENT / RECEIVED): **2/2**

NUMBER OF LIFTS: **10**

TYPE OF LIFT: 1 **CANTILEVERED PLATFORM**
 2

MANUFACTURER: **NATIONAL**
WHEEL-O-VATOR

MODEL #: 1 **BC-42**
 2

CAPACITY: **700 LB**

NUMBER OF LEVELS SERVICED: **2**

ACCOMMODATION: 1 **WITNESS BOX**
 2 **JUDGE'S BENCH**

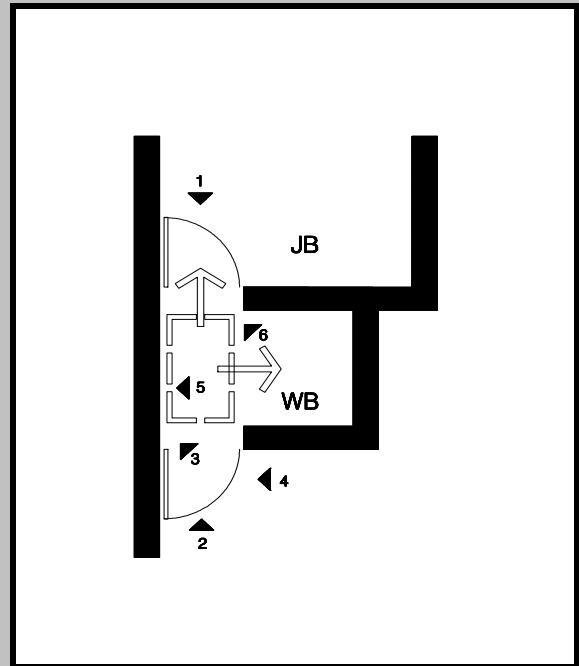

PLAN DIAGRAM AT LIFT LOCATIONS

CONSOLIDATED SURVEY & SITE VISIT INFORMATION:

This installation has a pit to provide a level transition between the platform and the courtroom well in the retracted position. A moveable step is placed adjacent to the platform, which is maintained at the witness box level for ambulatory participants. (Unlike the hydraulic lift design, the Acme screw drive will not settle at a lower elevation over time.)

There is minor vibration and noise when the lift is in operation. (It is steady and stable when loaded.)

There are significant horizontal gaps between the lift and adjacent fixed floor levels.

The most challenging aspect for integration of the lift into the courtroom architectural environment is the use of granite veneer on the access panels to the operating equipment. The weight of the panels, and possibility of chipping when they are removed for routine maintenance, will be a challenge for the operations personnel. From a practical standpoint it would have been better to continue the millwork across the back of the lift area and provide hardwood doors for equipment access.

In checking with the manufacturer of the lift, access for service could have been provided from the back of the drive tower, in an adjacent space.

The lift operation controls for the person occupying the lift are located high on the wall. They may comply with code, but should have been positioned lower on the wall, within the medium dimensional range of the standard.



Looking At The Lift Area From Courtroom Well Area

2



Looking Down From Judge's Bench Level

1



Gate And Controls At Lower Level

4



Gaps At Lift Edges

3

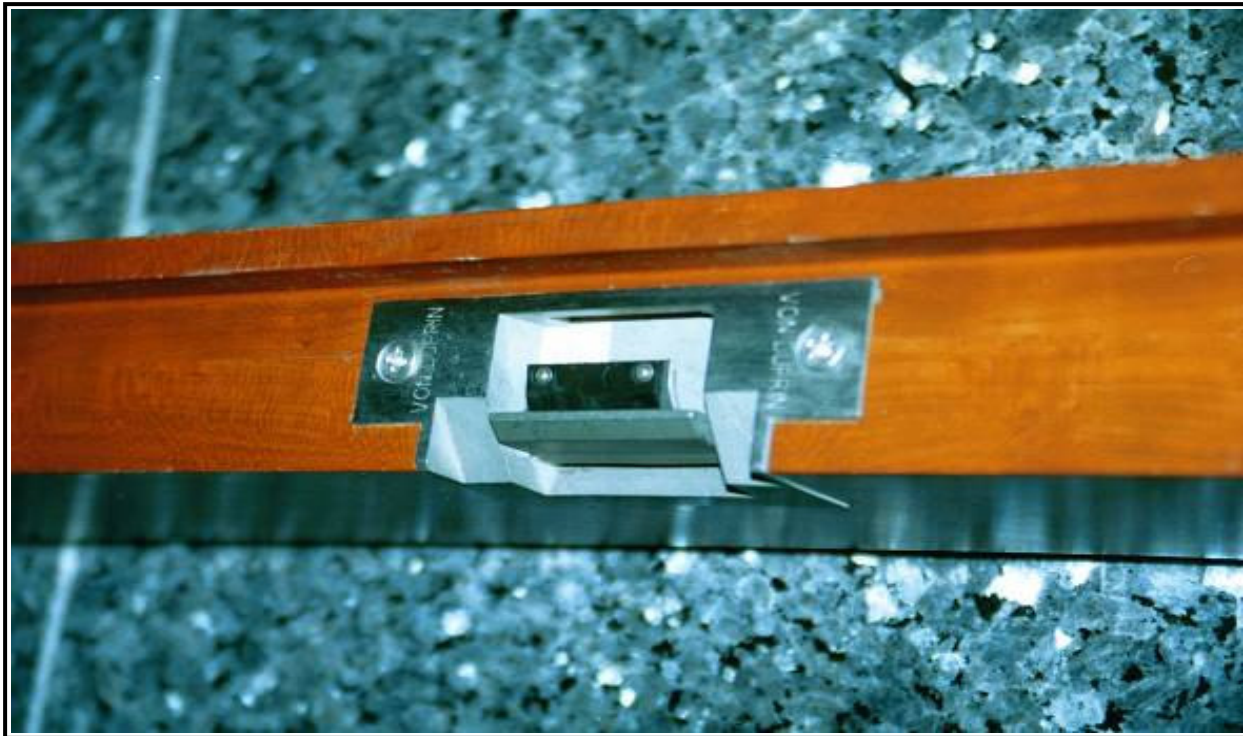

Electromagnetic Latch

6

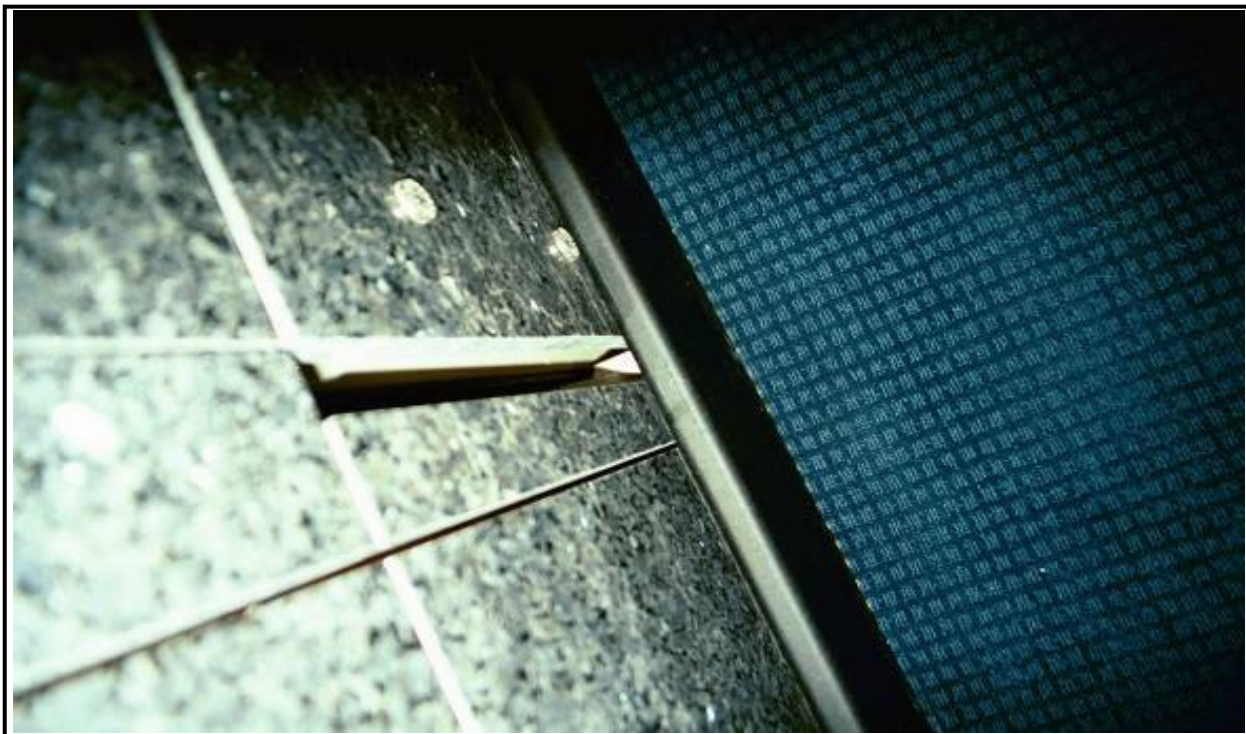

Detail At Recess For Cantilever Arm Movement

5

File: liftfm.j07

PROJECT / LOCATION:

MARICOPA COUNTY COURTHOUSE
PHOENIX, ARIZONA

SITE VISIT (Y/N):

SURVEYS (SENT / RECEIVED):

NUMBER OF LIFTS:

TYPE OF LIFT: 1
 2

MANUFACTURER:

MODEL #: 1
 2

CAPACITY:

NUMBER OF LEVELS SERVICED:

ACCOMMODATION: 1
 2

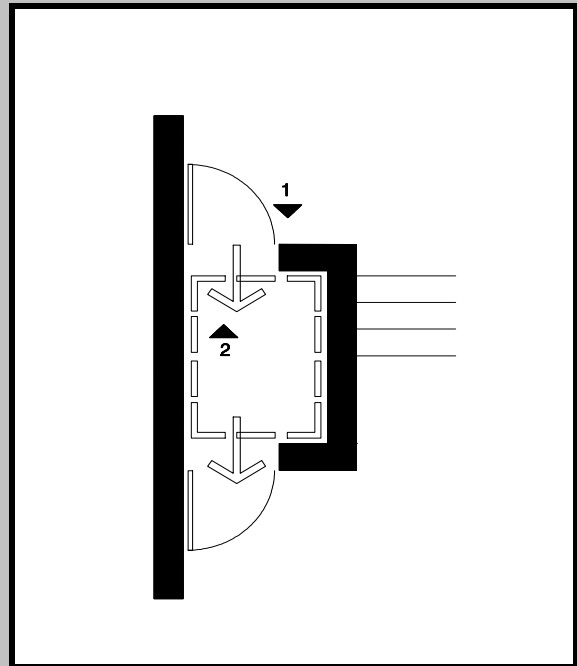

PLAN DIAGRAM AT LIFT LOCATIONS

CONSOLIDATED SURVEY & SITE VISIT INFORMATION:

This lift is 12 years old and is no longer in operation. It is an example of an entirely self-contained unit with the Acme screw mechanism enclosed in a tower. (The tower, the end gates, and an integral side panel with controls comprise the entire platform enclosure.)

Over time the infrequency of use, lack of maintenance, and provision of new accessible ramps as part of a building renovation have caused abandonment of the unit.

Maintenance personnel could not recall any significant operational problems over the life of the system.

No attempt was made to integrate the metal unit into the design of the courthouse lobby which made it appear as a very awkward element and overemphasized its presence.

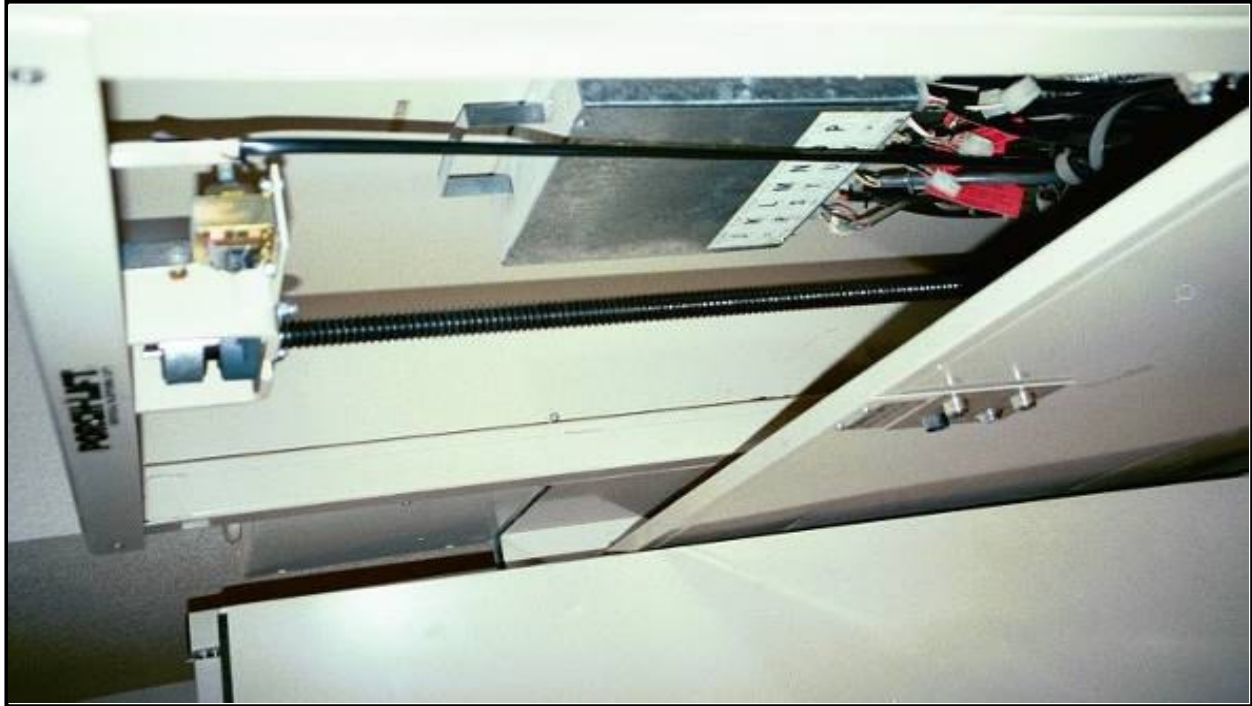

Acme Screw Drive Mechanism

2



Self-Contained Metal Lift Enclosure

1

File: liftfm.j07

PROJECT / LOCATION:

**ROMAN L. HRUSKA U.S. COURTHOUSE
OMAHA, NEBRASKA**

SITE VISIT (Y/N): Y

SURVEYS (SENT / RECEIVED): 4/2

NUMBER OF LIFTS: 9

TYPE OF LIFT:
1 HYDRAULIC / SCISSOR
2

MANUFACTURER:
 SOUTHWORTH /
 T.L. SHIELD

MODEL #:
1
2

CAPACITY:

NUMBER OF LEVELS SERVICED: 1

ACCOMMODATION:
1 WITNESS BOX
2

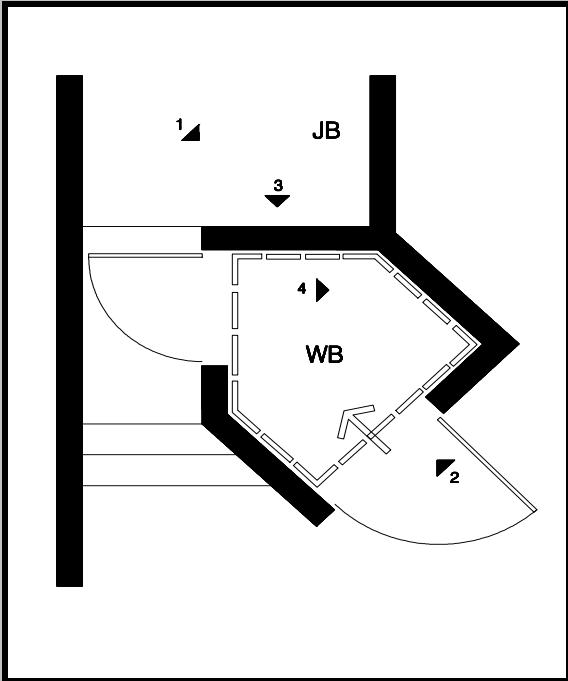

**PLAN DIAGRAM AT LIFT LOCATIONS
(WITNESS BOX - FIRST DESIGN)**

CONSOLIDATED SURVEY & SITE VISIT INFORMATION:

The most significant characteristics of the lifts at this facility are the shapes of the platforms. The challenges related to incorporation of these shapes has been the instability of the ride. The framework of the platform and the mechanism used to raise the lift were not adequately reconfigured from the standard rectangular shape to compensate for the irregular loading forces. Original factory fabricated perimeter reinforcing flanges had to be removed and platforms field modified due to insufficeint coordination with the millwork enclosure. (Reinforcement was accomplished by a local welder hired by the supplier.)

Maintenance items on these units have included: leaking check valves and hydraulic hose; ineffective gate latch contacts; a faulty height-limit switch; plus too much tolerance at the bearings and track on the height limit cable control. (Scheduling of service on all of these items was a challenge.)

The pit is deep enough to provide direct access from the courtroom well level without a short ramp.

Equipment access panel has carpet applied with no frame and the edges are frayed.

Local GSA contractor provides quarterly maintenance.

Both lift platform designs comprise the entire witness box area and must be at an elevated position for ambulatory use. (This position is retained by constant hydraulic pressure.)

Irregular configurations make it difficult to achieve minimum gaps between the platform and the millwork enclosure.

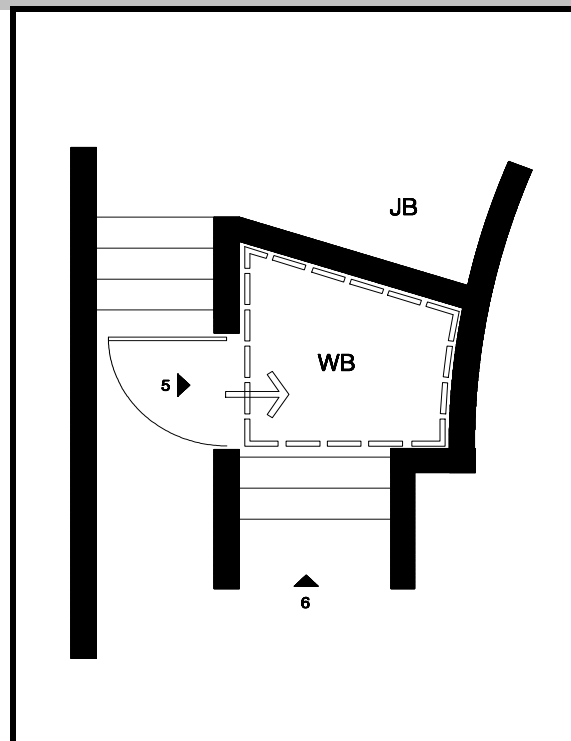

**PLAN DIAGRAM AT LIFT LOCATIONS
(WITNESS BOX - SECOND DESIGN)**

1



Judge's Bench Looking At Trapezoidal Shaped Witness Box

2



Note: Substantially Differing Heights Of Lift Controls

3



Platform And Witness Box Level

4



Irregular Edge Of Platform Results In Large Gaps

5



Entrance To Lift

6



Note: Board Placed Manually As Barrier At Steps

File: liftfm.j07

PROJECT / LOCATION:

SANDRA DAY O'CONNOR
U.S. COURTHOUSE - PHOENIX, ARIZONA

SITE VISIT (Y/N): Y

SURVEYS (SENT / RECEIVED): 1/1

NUMBER OF LIFTS:

TYPE OF LIFT: 1 **HYDRAULIC / SCISSORS**

TYPE OF RAMP: 2

MANUFACTURER: **SOUTHWORTH /**
T.L.SHIELD

MODEL #: 1
 2

CAPACITY:

NUMBER OF LEVELS SERVICED: 1

ACCOMMODATION: 1 **WITNESS BOX**
 2

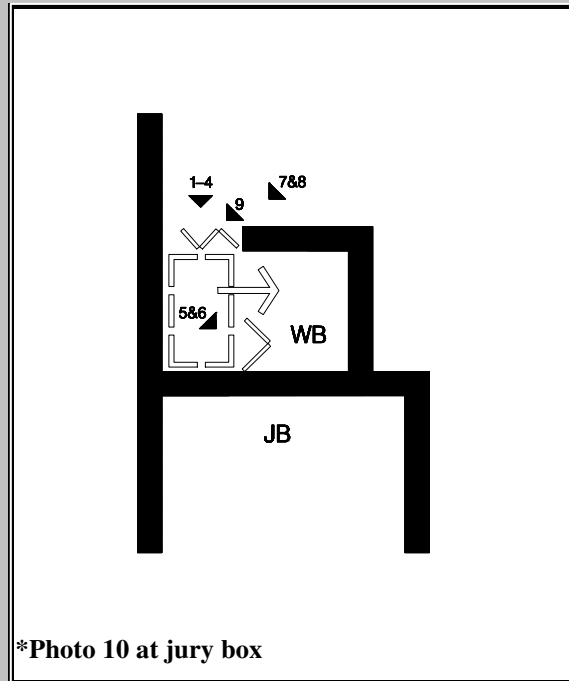

*Photo 10 at jury box

PLAN DIAGRAM AT LIFT LOCATION

CONSOLIDATED SURVEY & SITE VISIT INFORMATION:

The design intent of this installation was to absolutely minimize the impact of the lift, and its operating elements, on the appearance of the courtroom. A three riser stair element and landing platform, located directly over the lift, must be removed before it can be utilized. Each of these elements required two people to move them away from the witness box area. The recessed handles on the stair element broke while the demonstration was in progress.

Bi-fold panels are used to form the entry to the lift area at the courtroom well level and witness box. Neither set had a clip mechanism to hold them in the folded position, therefore they protruded from the wall recess.

When the folding panels, which are less than one inch thick, at the courtroom well entry, were closed they would bind because the guides and the floor track were too weak for the size of the panels. (Closure hardware was also sub-standard.)

Most coordination between the lift manufacturer/installer and the architect for the accommodation and enclosure were done by Requests for Information during the Construction Administration Phase of the project.

The access panel to service the electrical panel and hydraulic pump is in the fixed floor section of the witness box.

The lift platform does not have a finished surface.

In addition to the lifts, a manually activated ramp element is located at the jury box. It has the same issues related to finish details as the lift accommodation.

This installation epitomizes the situation where the best of intentions were not met because the timing within the project process did not allow adequate investigation of the millwork and other finish details. Even though the lift is in use only a small percentage of the time; the inconvenience and labor intensity of the adaptation process over-emphasizes the user's disability which is contrary to the philosophy of both the U.S. Courts and GSA.

1



Lift Concealed

2



Removal of 3-Step Riser

3



Removal Of Witness Box Platform

4



Lift Platform At Base Position

5



Folding Panels Protruding From Recess

6



Folding Panels Forming Enclosure

7



Damaged Folding Panels

8



Close-up Of Damage

9



Clamp At Top Of Folding Panels

10

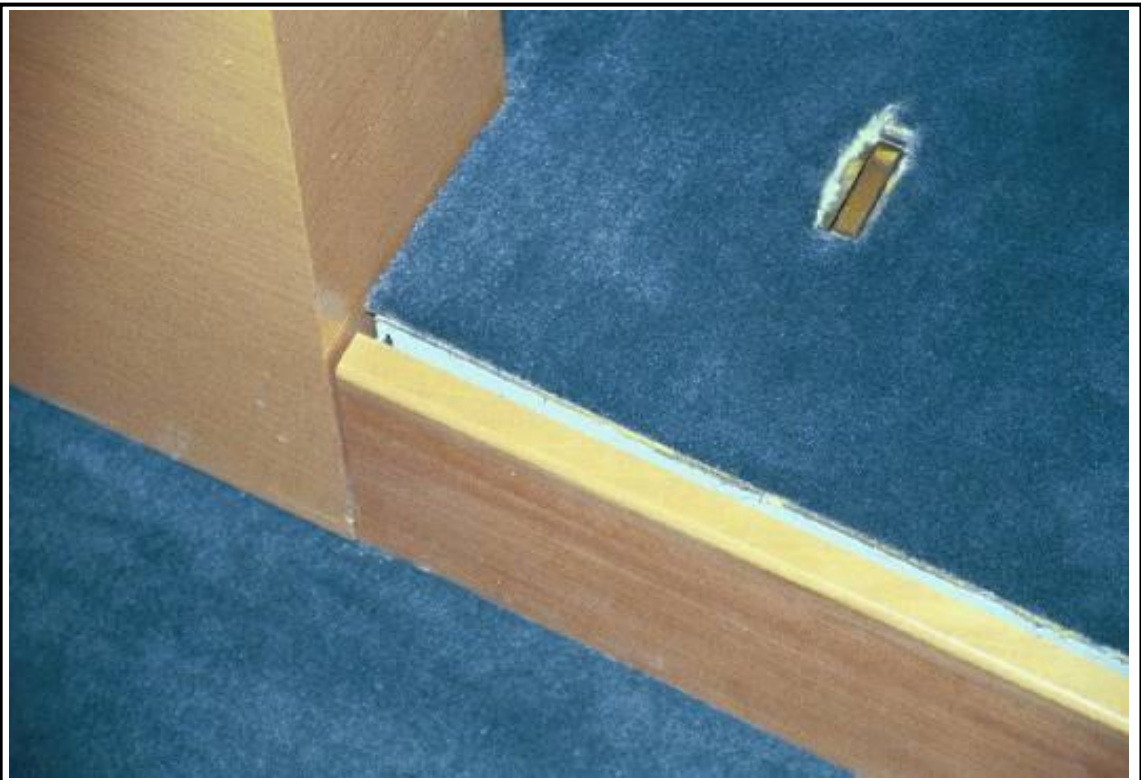

Ramp Edge At Jury Box

File: liftfm.j07

PROJECT / LOCATION:

WILLIAM J. NEALSON U.S. COURTHOUSE
SCRANTON, PENNSYLVANIA

SITE VISIT (Y/N): **Y**

SURVEYS (SENT / RECEIVED): **4/4**

NUMBER OF LIFTS: **2**

TYPE OF LIFT: 1 **HYDRAULIC / SCISSORS**
 2

MANUFACTURER: **CUSTOM**

MODEL #: 1
 2

CAPACITY:

NUMBER OF LEVELS SERVICED: **2**

ACCOMMODATION: 1 **WITNESS BOX**
 2 **JUDGE'S BENCH (FUTURE)**

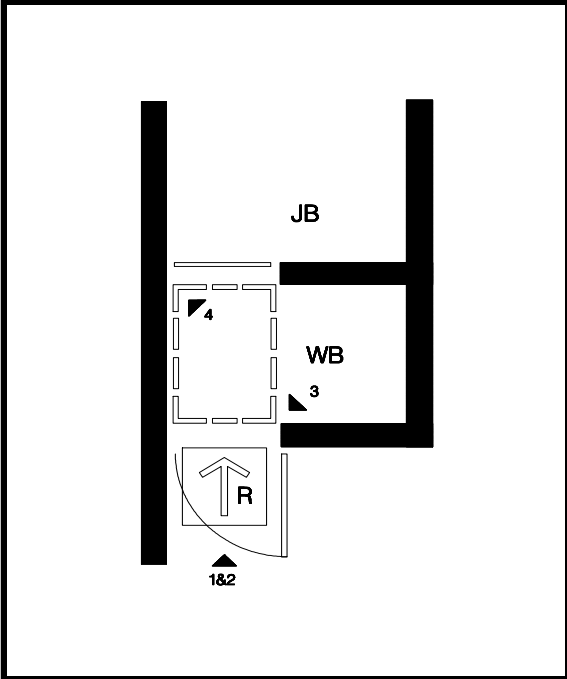

PLAN DIAGRAM AT LIFT LOCATIONS

CONSOLIDATED SURVEY & SITE VISIT INFORMATION:

A two-stop unit was installed in each of two courtrooms located in the new construction; built as an annex to the existing Courthouse and Federal Office Building. As designed, the unit provides accessibility for the witness box at the first stop; however, the second stop, providing access to the judge's bench, has been disconnected. The platform is approximately 5 FT-2 IN wide (facing the courtroom well) by 3 FT-1 IN deep. A 3 FT-3 IN wide door, with hinges toward the courtroom well, provides access to the witness box. A 3 FT-1 IN wide door, with hinges away from the courtroom well, provides access to the judge's bench from the witness box.

The witness box unit rises to a height of approximately 14 IN above the floor. *The floor slab below the lift platform was initially cut to an insufficient depth and needed additional space of approximately 4 IN below the surface.* The platform can be dismantled for servicing of the lift mechanism. All other equipment and hydraulics are located below the judge's bench platform, accessed through a floor panel.

A fixed ramp, approximately 1 FT-8 IN wide by 3 FT-0 IN deep having a 3 IN rise, provides access to the platform at its lowest operating position. The platform is normally placed at a raised position, accessed by portable steps for ambulatory witnesses.

Clearances between the platform and adjacent fixed floor levels exceed 1 IN.

There is a mechanism to prevent operating the lift when the gate is open, but there is no mechanism to prevent opening the gate when the platform is raised.

Operation is generally smooth, but there is a "clicking" noise when the platform reaches the lowest level.

It is possible to stop and start during a travel cycle.

Once the platform is at the raised height, it should remain at that position; however, it has a tendency to slowly drop over a short period of time.

A custom piece of folding hardware must be fitted onto the platform to be raised to the judge's bench height. When inserted, this hardware was misaligned and scrapped the adjacent fixed platform.

The platform is not rigid and stable, resulting in a substantial amount of flex.

Carpet is frayed at all edges where platform meets the adjacent fixed floor surfaces.

Access to the judge's bench from the platform was disconnected due to excessive movement and flex when the lift was raised to that level.

The components of the lift were well integrated into the millwork, although modifications to the design became necessary when the substitute manufacturer could not meet the project requirements.

The manufacturer, selected by substitution, did not produce a stable installation. *The acceptance of a non-standard, poorly engineered product led to the Court representatives deleting wheelchair lifts from the renovated courtrooms in the existing building.*

The lift occupies only a portion of the witness box floor area, with no wheel stops provided for conditions when the lift is at a different level.

1



Lift At Lowest Level

2



Lift With Manually Installed Wheel Stop And Ramp In Foreground

3



Lift Control And Witness Box Level

4



Platform Carpet Cover With Frayed Edges

File: liftfm.j07

PROJECT / LOCATION:

MAX ROSENN U.S. COURTHOUSE
WILKES-BARRE, PENNSYLVANIA

SITE VISIT (Y/N): Y

SURVEYS (SENT / RECEIVED): 3/3

NUMBER OF LIFTS: 1

TYPE OF LIFT:
 1 **HYDRAULIC / SCISSORS**
 2

MANUFACTURER:
SOUTHWORTH /
T.L.SHIELD

MODEL #:
 1
 2

CAPACITY:

NUMBER OF LEVELS SERVICED: 2

ACCOMMODATION:
 1 **WITNESS BOX**
 2 **JUDGE'S BENCH**

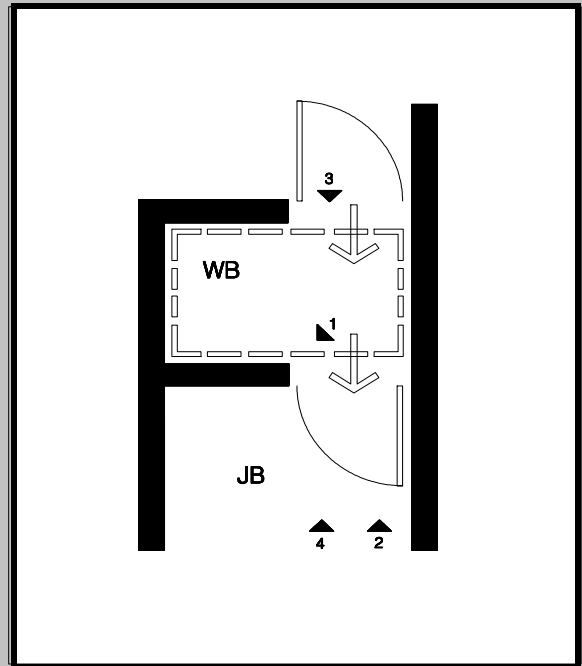

PLAN DIAGRAM AT LIFT LOCATION

CONSOLIDATED SURVEY & SITE VISIT INFORMATION:

The entire witness box level is a lift platform. In the ambulatory witness setting, the platform is raised 7 IN and maintained under hydraulic pressure.

The gaps at the perimeter of the platform and the enclosure are minimum. All edge conditions are finished with a molding element.

This project was a retrofit, from office space, and required cutting the floor slab down 4 IN for the lift equipment pit.

The electrical panel and hydraulic motor are accessible through a well-detailed removable floor section.

The millwork enclosure appears lower than 42 IN minimum height required, when lift is raised to judge's bench level.

1



Lift At Judge's Bench Level

2



Witness Box From Judge's Bench

3



Transition From Courtroom Well To Witness Box

4



Access To Electrical Panel At Hydraulic Pump In Judge's Bench Floor

File: liftfm.j07

PROJECT / LOCATION:

HERMAN T. SCHNEEBELI U.S. COURTHOUSE
WILLIAMSPORT, PENNSYLVANIA

SITE VISIT (Y/N): **Y**

SURVEYS (SENT / RECEIVED): **4/3**

NUMBER OF LIFTS: **2**

TYPE OF LIFT: **1 CANTILEVERED PLATFORM**
2 SCISSORS / HYDRAULIC

MANUFACTURER: **CONCORD**
SOUTHWORTH / T.L. SHIELD

MODEL #: **1**
2

CAPACITY:

NUMBER OF LEVELS SERVICED: **1 EACH**

ACCOMMODATION: **1 WITNESS BOX**
2 JUDGE'S BENCH

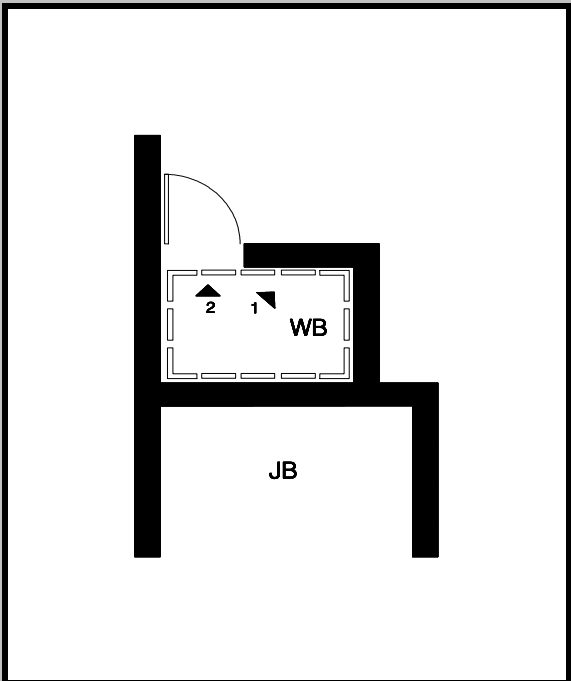

PLAN DIAGRAM AT LIFT (WITNESS BOX)

CONSOLIDATED SURVEY & SITE VISIT INFORMATION:

Mechanical lifts independently service the witness box and judge's bench. Both units are installed at a third floor location, in office areas recently converted to courtroom use.

WITNESS BOX LIFT:

The witness box unit rises to a height of approximately 7-1/2 IN above the floor. The slab below the lift platform was cut out, new steel reinforcing put in, and a new floor slab was poured-in-place, approximately 4 IN below the surface.

The platform can be pivoted up 90 degrees for servicing of the lift mechanism. All other equipment and hydraulics are located below the slab, and accessed through the ceiling below.

Clearance between the platform and surrounding millwork is approximately 1/2 IN along the sides and back, and 1 IN at the front. (When the access door is closed, there is approximately a 3-1/2 IN space between the platform and the gate.)

There is a control to prevent operating the lift when the gate is open, but no mechanism to prevent opening the gate when the platform is in a raised position. (According to the building engineer, the electromagnetic strike was removed during installation.)

Raising the platform is accomplished by push button control, either from inside or from outside the witness box, with the gate closed. (Operation is smooth and not quiet.)

Similarly, lowering the platform is accomplished in the same manner. (Operation is generally smooth, with a slight scraping noise near the end of the travel cycle. There is also a slight popping noise from the pump whenever the cycle is initiated. It is possible to stop and start during a travel cycle.)

The platform is level, rigid, and stable, plus it does not flex when loaded.

JUDGE'S BENCH LIFT:

The second unit provides accessibility for the judge's bench. It is accommodated within a room approximately 4 FT-2 IN wide by 4 FT-6 N deep, adjacent to the courtroom, accessible off the the ante-room serving the secure corridor and judges chambers. (The platform is approximately 3 FT-2 IN wide by 4 FT-0 IN deep.)

A pair of 3 FT-6 IN wide doors, interconnect to prevent opening both at the same time, provide upper and lower access to the lift.

Clearances between the platform and doorways is approximately 1/2 IN along the front and back.

When the access doors are closed, there is approximately a 1-1/2 IN space between the raised platform and the lower door.

There is a mechanism to prevent operating the lift when the doors are open, and also a control to prevent opening the doors when the platform is in operation.

The anteroom access doors have strikes near the top that engage when the platform is in operation. There are metal rods that project horizontally from these strikes and engage small diameter holes cut into the doors. It appears that these rods serve the function of accessing and overriding the mechanism from outside the room in case of a mechanical failure

Raising or lowering the platform is accomplished by holding in a button, either from the platform or from outside the access doors. (Operation is generally smooth, but is very noisy.)

It is not possible to stop and start the lift during a travel cycle. If travel is interrupted, it must be resumed in the opposite direction.

1



Controls Within The Witness Box

2



Gate And Floor Joint Within The Witness Box

3



Anteroom With Self-Contained Lift Adjacent To Judge's Bench

4



Controls And Rail At Judge's Bench Lift

SECTION SIX

AVAILABLE MECHANICAL LIFT SYSTEMS

(LISTED BY MANUFACTURER)

PRODUCT SEARCH

There are several mechanical lift concepts available to assist physically disabled people in obtaining access to elevated areas of the courtroom. They can be categorized in the following manner:

- (1) Hydraulic/Scissors Lift
- (2) Cantilevered Platform
- (3) Portable Lift Unit
- (4) Inclined Platform Lift

The most practical methods to accommodate witnesses, jurors, and the judge are the hydraulic/scissor and the cantilevered platform units. The primary reason to use either of these systems is the relatively minimal impact they have on the overall architectural features of the courtroom, and the potential minor disruption to the judicial proceedings when the units are put into service.

The information in this section represents only a brief synopsis of the design characteristics for the nine different mechanical lift systems that were identified during this Analysis. A comparison of the manufacturer's products, based on a common outline of system characteristics, is provided on the next page.

MECHANICAL LIFT SYSTEMS COMPARISON

(INVESTIGATION BY HDR & LERCH / BATES)

EVALUATION CRITERIA:

MEETS BASIC REQUIREMENTS (COURTROOMS) >

STANDARD PRODUCTION SYSTEM:

WILL THEY PROVIDE THEIR BASIC OPERATIONAL PLATFORM & DRIVE MECHANISM COORDINATED WITH A CUSTOM ENCLOSURE?

TYPE OF DRIVE MECHANISM:

IS THERE LEVELING ADJUSTMENT CAPABILITY? (WITHIN FRACTIONS OF AN INCH.)

HAVE THEY EVER PROVIDED WITNESS BOX & JUDGE'S BENCH LIFTS?

HOW MANY INSTALLATIONS?

ARE THEY DOING ANY PRODUCT REFINEMENTS / RESEARCH APPLICABLE TO THEIR LIFT DESIGN?

DO THEY PROVIDE A MODEL REQUIRING PIT?

DO THEY PROVIDE A MODEL WITHOUT A PIT REQUIREMENT?

IS A PORTABLE UNIT AVAILABLE?

WILL THEY BID ON LIFTS FOR COURTROOMS?

UNIFORMITY / CONSISTENCY OF PRODUCT (RANGE 1- 5) LOW - HIGH (DETERMINED BY LERCH, BATES & ASSOC. ELEVATOR / LIFT ENGINEERING)

GENERAL INFORMATION

NOTE: NOT ALL MANUFACTURERS LISTED CAN PROVIDE LIFTS FOR A FREESTANDING WITNESS BOX OR JURY BOX DUE TO INFLEXIBILITY OF TOWER / MAST HEIGHT.

CONTACTS

	SOUTHWORTH / T.L. SHIELD	GARAVENTA (GENESIS SERIES)	INCLINATOR	ACCESS INDUSTRIES	NATIONAL WHEEL-O-VATOR	ASCENSION	CONCORD	VERTICAL MOBILITY	GIANT LIFT
STANDARD PRODUCTION SYSTEM:	SCISSORS PLATFORM	CANTILEVERED PLATFORM W/ TOWER OPERATION	CANTILEVERED PLATFORM W/ TOWER OPERATION	CANTILEVERED PLATFORM W/ TOWER OPERATION	CANTILEVERED PLATFORM W/ TOWER OPERATION	PORTABLE	CANTILEVERED PLATFORM W/ TOWER OPERATION	CANTILEVERED PLATFORM W/ TOWER OPERATION	CANTILEVERED PLATFORM W/ TOWER OPERATION
		INCLINED PLATFORMS			INCLINED PLATFORMS				
					PORTABLE				
WILL THEY PROVIDE THEIR BASIC OPERATIONAL PLATFORM & DRIVE MECHANISM COORDINATED WITH A CUSTOM ENCLOSURE?	YES	YES	NO	YES	YES	NO	YES	YES	YES
TYPE OF DRIVE MECHANISM:	HYDRAULIC	ACME SCREW	HYDRAULIC CHAIN	RECIRC. BALL SCREW	ACME SCREW	HYDRAULIC	CABLE HYDRAULIC	SCREW DRIVE	HYDRAULIC CHAIN
		HYDRAULIC OPTION		ROPE HYDRAULIC OPTION					
IS THERE LEVELING ADJUSTMENT CAPABILITY? (WITHIN FRACTIONS OF AN INCH.)	YES	1/2" IN FIELD	YES	CAN BE MADE WITHIN 3/8"	CAN BE MADE WITHIN 3/8"	YES	YES	YES - LIMIT SWITCH ADJUSTMENTS	YES - LIMIT SWITCH ADJUSTMENTS
HAVE THEY EVER PROVIDED WITNESS BOX & JUDGE'S BENCH LIFTS?	YES	YES	YES	YES	YES	1	YES	YES	YES
HOW MANY INSTALLATIONS?	>200 (21 U.S. CTS)	>6	>5	>10	>200 (10 U.S. CTS.)	1	>10	>10	>10
ARE THEY DOING ANY PRODUCT REFINEMENTS / RESEARCH APPLICABLE TO THEIR LIFT DESIGN?	NO	NO	NO	NO	NO	NO	NO	NO	NO
DO THEY PROVIDE A MODEL REQUIRING PIT?	YES	YES	NO	YES	YES	N/A	YES	NO	YES (3 1/4" RAMP RQD.)
DO THEY PROVIDE A MODEL WITHOUT A PIT REQUIREMENT?	YES	YES	YES	YES	YES	N/A	YES	YES	YES (3 1/4" RAMP RQD.)
IS A PORTABLE UNIT AVAILABLE?	NO	NO	NO	YES (DOES NOT MEET ADA)	YES	YES (WILL MEET ADA)	YES	NO	NO
WILL THEY BID ON LIFTS FOR COURTROOMS?	YES	YES	YES	YES	YES	NO	YES	YES	YES
UNIFORMITY / CONSISTENCY OF PRODUCT (RANGE 1- 5) LOW - HIGH (DETERMINED BY LERCH, BATES & ASSOC. ELEVATOR / LIFT ENGINEERING)	5	5			5	N/A	2	N/A	
GENERAL INFORMATION	SOUTHWORTH MANUFACTURERS THE LIFT & T.L. SHIELD DOES ALL CONTROLS & INSTALLATION. CHECK VALVE CHANGED TO STOP "SINKING". RECOMMEND CYCLING THE SYSTEM 17 / WEEK. ONE CODE ISSUE IS "THE HANDRAIL". ANSI APPROVED UNDER "NEW TECH." DESIGNATION.	WALL PANELS CAN BE ELIMINATED, EXCEPT ONE WITH CONTROLS & RAILING MOUNTED ON IT. HAVE USED INCLINED LIFT IN COURTROOM. NEED ACCESS TO TOP OF EQUIPMENT TOWER FOR SERVICE. TOWER HEIGHT IS 61 3/8".	TWO MODELS: (1) STEEL ENCLOSURE W/ 6"-8" TOWER. (2) INTEGRAL FIBERGLASS ENCLOSURE W/ 8" HIGH TOWER. (NOISE IS A FACTOR W/ THE STEEL UNIT.)	TWO MODELS: SHAFT MODEL & ENCLOSURE MODEL. CAN INCORPORATE CUSTOM MILLWORK.	THREE STOP LIFT >24" W/ TOWER OF 45" HEIGHT. THEY DO NOT RECOMMEND USE OF THEIR PORTABLE LIFT IN COURTROOMS. FRONT OR BACK SERVICE ACCESS IS AVAILABLE.	NOT PRACTICAL FOR MANEUVERING IN A COURTROOM ENVIRONMENT.	BOTH FIXED OR PORTABLE UNITS ARE AVAILABLE.	THE STEP IS INTEGRAL W/ THE GATE.	INDUSTRIAL UNIT.
CONTACTS	EVELLYN (NATIONAL) (818) 589-8228	CARY (INTERNATIONAL) (800) 663-6556	JEFF (NATIONAL) (800) 343-9007 EASTERN ELEVATOR RAY CLARK (940) 631-9180	KEVIN DUNWORTH AREA ACCESS FALLS CHURCH, VA. (703) 573-2111 (703) 207-0446 FAX	KEITH (NATIONAL) (800) 581-9685	LINDA GREEN (NATIONAL) (800) 459-0440	DONNA CONSOLIDATED ELEVATOR (760) 393-2510	JIM LEACH (937) 236-2888	DONNA (800) 52-GIANT

(1) **SOUTHWORTH / T.L. SHIELD**
(INVISIBLE LIFT)

This model was the most frequent installation at the courthouses visited during the Analysis. (Eleven of 16 facilities had the *Invisible Lift*.)

Southworth manufactures the lift platform and its supporting frame; and the T.L. Shield Company provides both the operational controls and coordination of the lift installation. The *Invisible Lift* design has evolved from industrial models used to move bulk materials between various levels within a warehouse environment. The typical courtroom installation had the platform surface clad with carpet; gate controls mounted in the millwork; and lift movement controls placed within a stanchion mounted to the platform. (Many installations also included wall-mounted controls in lieu of the stanchion.)

The problems related to the use of this unit were consistent, though not apparent at every installation. The primary issue was sinking of the platform, due to the dependence on hydraulic pressure, if it was maintained in a raised position for a long period of time.

The manufacturer should investigate the possibility of providing retractable struts to support the platform at elevated positions over an extended period of time, without the dependence on hydraulic pressure. The typical position for ambulatory access to the raised courtroom functions should be with the platform at its lowest position, resting on the base frame, flush with the courtroom well floor.

None of the *Invisible Lift* installations observed during the site visits had a handrail mounted on the platform. The manufacturer's representative indicated that a code variance to eliminate this requirement was not difficult to obtain due to the minimum variations in height between landings. (Southworth has provided handrails mounted to the platform when it was absolutely deemed necessary by the jurisdiction.)

The area under the platform is only accessible for service within the dimensional limits from the courtroom well floor to the highest landing, which is typically 24 in. (Some installations accommodate the witness box level only, with the resultant service clearance of approximately 7 in.)

Check valve replacement on this hydraulic/scissors lift system has eliminated the sinking platform issue, according to a manufacturer's representative, and they have no immediate plans to incorporate retractable struts into the system to maintain a raised platform over an extended period of time.



T. L. SHIELD AND ASSOCIATES, INC.

The Invisible Lift™



Break the barrier dilemma with the custom, visually pleasing INVISIBLE LIFT™. This architectural solution to the "industrial look" is designed to provide adequate lifting capabilities while saving valuable space by concealing the entire lift mechanism. Additional custom features include colors, materials, and finishes to blend with your surrounding decor. Proven dependability, easy maintenance, and safety features provide many efficient and practical possibilities, indoors and out. Courthouses and other buildings faced with specialized requirements are easily brought into ADA compliance with this popular and economical alternative to standard wheelchair lifts.

VERTICAL INVISIBLE WHEELCHAIR LIFT™

1. GENERAL

1.01 Description of product: The product described herein is a custom manufactured, vertical wheelchair platform lifting device consisting of a lifting platform, selected and dimensioned to provide adequate lifting height to suit the individual building requirement. The Lift can be used indoors and out to vertically transport a wheelchair user, or other mobility-impaired person, up and over a low-rise barrier created by stairs, thus creating access to the building interior.

1.02 Scope: Furnish all labor, material and equipment required to complete the wheelchair lift as shown on the drawings and specified herein. Concrete pit shall be provided by General Contractor if so designed. Wheelchair lift shall be installed so gates (by others) will only open when the lift is at the elevation of the adjoining floor.

2. QUALITY ASSURANCE

2.01 Manufacturer: A company with no less than eight (8) years of experience in the design, fabrication and installation of specialized lifting equipment for handicapped and geriatric consumers should supply the lift. Wheelchair lift - INVISIBLE LIFT custom manufactured by T.L. SHIELD & ASSOCIATES, INC., Post Office Box 6845 Thousand Oaks, CA 91359-6845, (818)509-8228 FAX (818)509-8596 & 2605 Saklan Indian Drive, Walnut Creek, CA 94595, (510)934-2714.

2.02 Technical Services: Manufacturer and authorized dealer (where applicable) should maintain a team of design personnel to work with architects, engineers, contractors and must visit the site prior to installation in order to adapt the wheelchair lift product to the design and structural requirements of the building or site.

2.03 The unit shall be easy to operate by the user or attendant and be capable of functioning in all weather conditions. Unit shall have the capacity to lift up to 750 lbs. to the desired lifting height up to a maximum lift height as specified in drawings.

2.04 Composition and Materials: Speed -10 feet per minute (est.) Drive System - Motor shall have maximum 3/4 Horse Power, 115/230V, 60 HZ, 30AMP single phase intermittent duty cycle, super torque motor. Integral oil reservoir and torsion tube, 63 mesh suction line oil filter, high pressure gear pump containing an integral check relief valve and down solenoid valve cartridge with filter. The coil operating voltage is 24 volts AC. Liquid tight strain relief type electrical cord connectors. Hydraulic hoses SAE 100 R2AT double wire braid, pressure line 25 micron cartridge filter. Vented oil filler plug, pressure compensated flow control valve is furnished for consistent lowering speeds.

2.05 Safety features: Standard up and down limit switches with a backup final limit switch which cuts power to the entire unit in the event of a switch failure. Platform size as per drawings, key switch control on platform center stanchion and standard upper & lower level call/send controls. All operating controls are low voltage 24 volt.

2.06 Items by others: 0% slope recessed concrete pad with the dimensions as per drawings and a stress load of 3500 psi. Electrical service to the lift's control panel to be by others. Thus, electrical service is to be terminated with a disconnect switch. 1/2" conduit to be run from lift control panel to lower level call/send, upper level call/send and to J-box mounted below the lift. 1/2" conduit to be run from lift control panel to each electric door strikes. Provisions are to be made to eliminate any sheer points and maintain adequate clearances between Invisible Lift, sides, or gates and adjacent openings, railings, ceilings, or other architectural features. Provisions are to be made to allow T. L. Shield & Associates, Inc. to move the lift unit in one piece from a truck delivery point to the actual installation point.

2.07 Warranty: This product is covered by a limited 1 year warranty, a copy of which can be obtained upon request.

2.08 Finish: Primer coat weatherproof enamel - ready to accept final finish coat by others.

2.09 Construction: Bolted and/or welded corrosion resistant panels and frames.

3. INSTALLATION

3.01 Installation: Wheelchair lift shall be installed in strict accordance with manufacturers recommendations. Installer must be manufacturer trained and C11 licensed.

D-4413261

REV	DATE	BY	CHKD	DESCRIPTION
1				ISSUED FOR CONSTRUCTION
2				REVISED TO SHOW REVISIONS
3				REVISED TO SHOW REVISIONS
4				REVISED TO SHOW REVISIONS
5				REVISED TO SHOW REVISIONS

WIRE ON HOOKS FOR HOLDING BIKES SECURELY LOCATED AT POINTS INDICATED BY DASHED LINES TO BE RAN ON WALL AROUND PLATFORM'S UNDERSTOOP PERIMETER

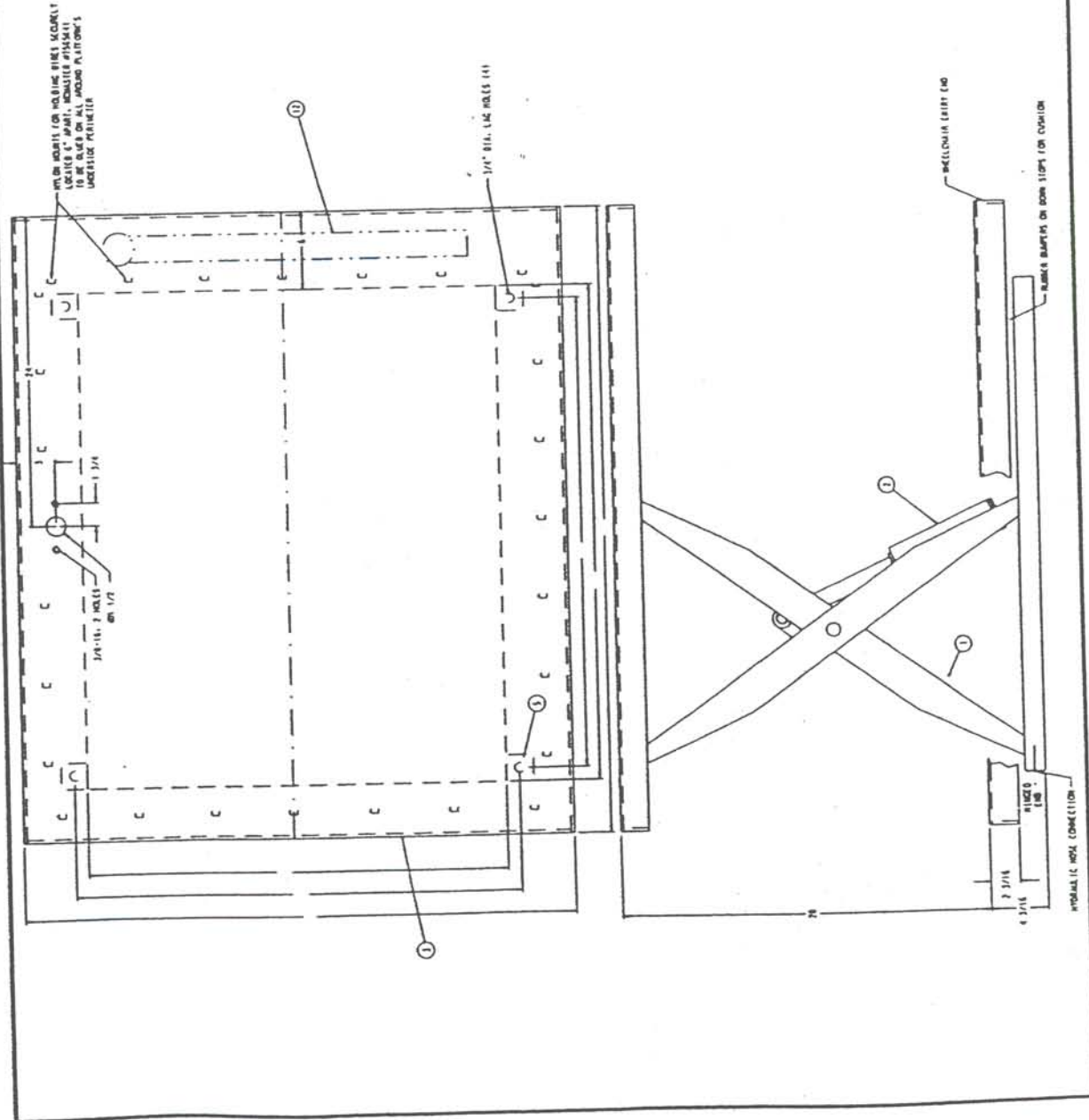

GENERAL DESCRIPTION

MODEL 1500-20
 WORKSHEET: 6 IN. OF 3/16" PLATE
 BASE: 37" x 34" WITH 8 INCH LUGS
 LOWERED POSITION: 4 3/16"
 CAPACITY: 500 LBS. WITH 1000 LB. LOAD
 LOWERING TIME: ADJUSTABLE WITH 1/2 RPM MAX. RISES CONTROL
 AT BASE OF EACH COLUMN FOR MAX DOWN SPEED OF 1.0 RPM
 MANUAL LOWERING VALVE INCLUDED
 POWER: 115-1-60, EXTENSION POWER UNIT
 CONTROL: 3-1/2" SOUTHORTH BEICE MOUNTED BY FRAME
 FINISH: TWO COATS SOUTHORTH BEICE MOUNTED BY FRAME

12	1	LIFT TABLE INSTALLATION	P-3041311
13	1	CONNECTION BILBOUR	P-3041312
14	1	HYDRAULIC CYLINDER	P-3041313
15	1	COIL DOWN VALVE 1/2" x 1/2"	P-3041314
16	1	MANUAL LOWERING VALVE	P-3041315
17	1	HYDRAULIC CYLINDER UNIT, INTERNAL	P-3041316
18	1	CONTROL UNIT	P-3041317
19	1	VALVE OF RELEASE	P-3041318
20	1	HYDRAULIC ARRANGEMENT	P-3041319
21	1	BASE AND LEG ASSEMBLY	P-3041320
22	1	CONTROL UNIT	P-3041321

REVISIONS (COPY THIS SHEET)	
NO.	DESCRIPTION
1	ISSUED FOR CONSTRUCTION
2	REVISED TO SHOW REVISIONS
3	REVISED TO SHOW REVISIONS
4	REVISED TO SHOW REVISIONS
5	REVISED TO SHOW REVISIONS

REVISIONS EXISTING COIL ON W/P
 SOUTHORTH
 LIFT TABLE ASSEMBLY
 D-4413261

(2) GARAVENTA ACCESSIBILITY
(GENESIS LIFT)

Garaventa manufactures cantilevered platform and inclined platform lift systems. (Neither of these systems was installed at any of the courtrooms visited during this Analysis.)

The standard cantilevered platform lift includes a painted steel or acrylic panelized enclosure mounted to the platform. All panels can be removed with the exception of the one that has the integrated system controls and handrail, located adjacent to the operating equipment.

The Acme screw drive mechanism is placed within the metal-clad 'tower' or 'mast' enclosure, having a standard height of 5'-1 3/8"; recessed within a wall cavity and serviced by means of a front or rear access panel. The access panel can be clad with materials that match adjacent room finishes. The recessed wall cavity is required to be 6 ft tall to allow service access at the top of the 'tower'.

System Overview

The Genesis vertical platform lift is offered in a variety of models for different accessibility challenges. This Design and Planning Guide applies to our hoistway unit which we call the Genesis Shaftway Model.

It consists of a complete vertical elevating system placed into a shaftway, constructed by others, fitted with doors and interlocks. It can be used to provide access indoors or outdoors.

The Genesis is constructed of a custom anodized aluminum extrusion mast frame and powder coated 16 gauge galvanized steel platform and most panels. The Genesis can be installed directly on the floor or in a 76 mm (3") deep pit. The mast of the lift must be anchored to the wall with support brackets.

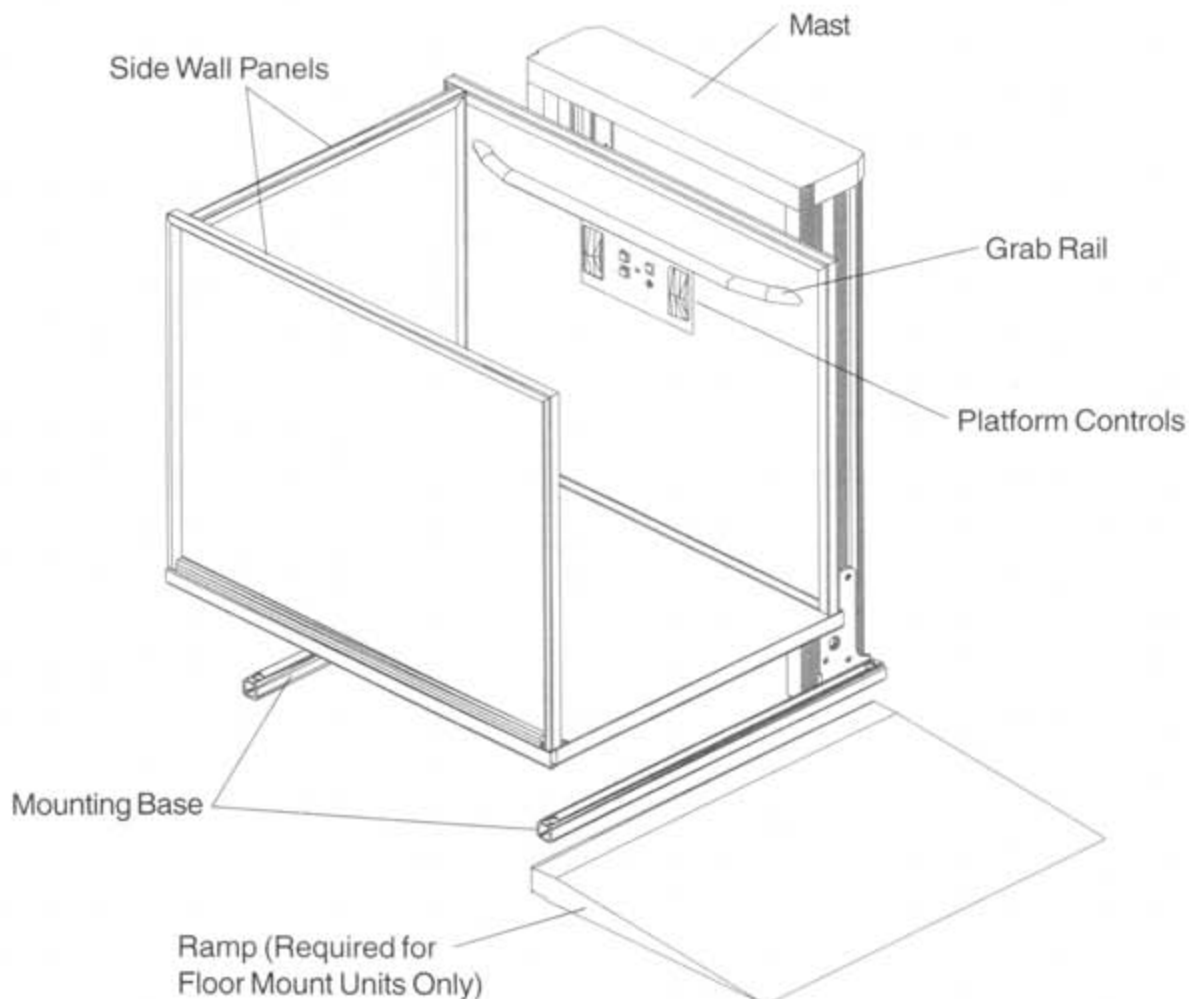

Fig. 1 - On/Off Same Side (Adjacent to Mast) Configuration

Drive System

Driven by a single-phase motor attached to a 1" ACME screw, the Genesis shaftway platform travels between landings at 3.35 meters (11 ft.) per minute.

The GVL-SW-41, GVL-SW-57 and GVL-SW-72 mast sizes are driven by a 0.75 H.P. motor

The GVL-SW-96, GVL-SW-120 and GVL-SW-144 mast sizes are driven by a 1.0 H.P. motor

Mains Power

The mains power requirement is 208 to 240 VAC, on a dedicated 15-amp circuit.

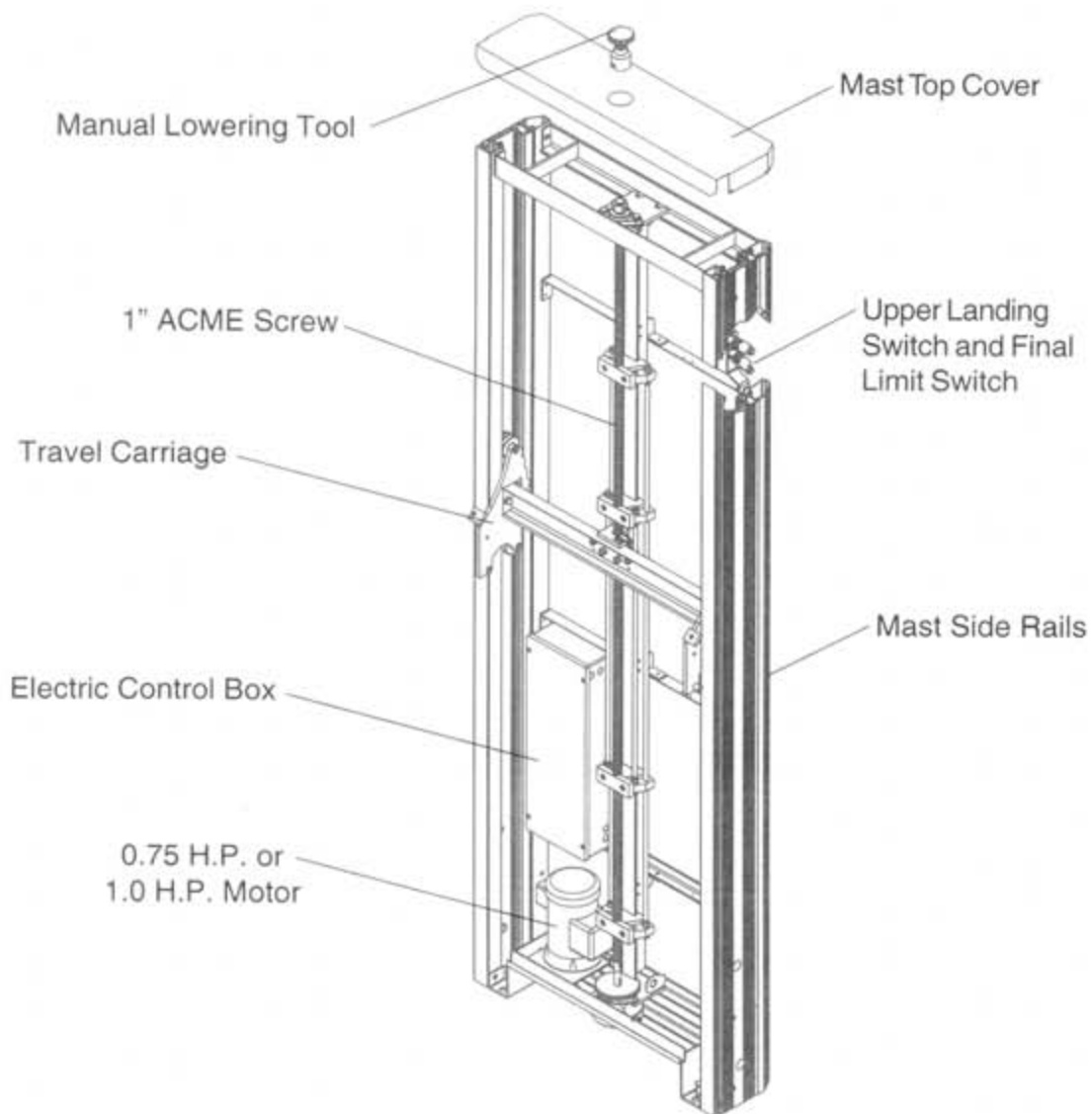

Fig. 4 - Drive System

Garaventa (Canada) Ltd.
7505-134A Street, Surrey, B.C. Canada V3W 7B3
Phone: 1+(604) 594-0422 Fax: 1+(604) 594-9915
Toll Free: 1-800-663-6556
www.garaventa.ca email: designhelp@garaventa.ca

**GARAVENTA GENESIS VERTICAL-LIFT
DESIGN SPECIFICATIONS**

**IMPORTANT: PLEASE CONTACT GARAVENTA FOR DEALER ASSISTANCE IN
DEVELOPING CURRENT AND LOCATION SPECIFIC DESIGN SPECIFICATIONS**

VERTICAL LIFT DESIGN SPECIFICATIONS

PART 1 GENERAL

1.01 DESCRIPTION OF PRODUCT

The product described herein - manufactured by Garaventa (Canada) Ltd., Surrey, B.C., Canada - is a vertical platform lift for indoor/outdoor use consisting of a machine tower with a lifting platform, selected and dimensioned to provide building access for mobility impaired persons.

1.02 QUALITY ASSURANCE

All load ratings and safety factors shall meet or exceed those specified in the local applicable elevator safety code and shall be certified by a professional engineer. Welders certified in accordance with requirements of CWBW47.1 shall execute all welding of parts. Design and installation shall be in compliance with applicable regulations of all governing agencies with jurisdiction.

MANUFACTURER

Supplier with design personnel available to work with architects/contractors to adapt product to requirements of building and with not less than twenty (20) years experience in design, fabrication, and installation of specialized equipment for mobility impaired persons.

INSTALLER

Must be a contractor licensed to install equipment of this scope, with evidence of experience with this equipment. The installer must also employ competent personnel, maintain an adequate stock of replacement parts, have qualified people available to ensure fulfillment of maintenance and call-back service without unreasonable loss of time in reaching the job site.

1.03 WARRANTY

- A. Warranty: Manufacturer shall warrant the Genesis vertical lift materials and workmanship for one year following completion of the installation.
- B. Extended Warranty: Manufacturer shall warrant the Genesis vertical lift materials and workmanship for three [five] years following completion of the installation and execution of a Preventive Maintenance Program Agreement for three [five] years.

1.04 MAINTENANCE

- A. The cost of renewals or repairs caused by reason of negligence, misuse, or accidents beyond the control of the lift contractor shall not be the responsibility of the contractor.
- B. If call-back service is required between regular inspections, and is necessitated by defects, which are not covered by the warranty, this contractor will be reimbursed by the owner. Call-back service necessitated by defects, which are covered by the warranty, shall be provided without charge.

PART 2 PRODUCT

This section covers the supply and installation of one vertical platform lift system.
(Optional equipment and selection items are underlined and are usually an extra cost).

2.01 MANUFACTURER/EQUIPMENT:

MODEL TYPE: Garaventa Genesis Vertical Lift with; (specify)

- 1041mm (41")
- 1448mm (57")
- 1829mm (72")
- 2438mm (96")
- 3048mm (120")
- 3658mm (144")

Max. lifting height and with; (specify)

- Compact - 915mm x 1262mm (36" x 49 1/2") Nominal
- Standard - 962mm x 1374mm (38" x 54") Nominal
- Mid-Size - 962mm x 1526mm (38" x 60") Nominal
- Large - 1089mm x 1526mm (43" x 60") Nominal
- Custom

platform manufactured by Garaventa (Canada) Ltd., Surrey, B.C. distributed by _____ configured as follows:

1. Machine Tower: Custom aluminum extrusion - anodized champagne finish.
2. Base Frame: structural steel tubing.
3. Platform side guard panels: 16 gauge galvanized steel sheet panels. Custom anodized aluminum extrusion tubing frame.
4. Enclosure Panel: 16 gauge galvanized steel sheet, acrylic panels (optional).
5. Platform and Access Ramp: 16 gauge galvanized steel plates; slip-resistant surfaces.
6. Coatings/Surfacing: Finished in process consisting of alkaline detergent wash, clear water rinse, iron phosphate coating, clear water rinse, non-chromate rinse, and baked polyester electrostatically applied for indoor/outdoor use.
7. Drive: self-lubricating acme drive nut and screw gear belt pulley with gearbelt.
8. Emergency Operation: (1) Battery powered emergency lowering device capable of lowering platform and (2) Manual lowering device capable of raising or lowering platform in event of power or component failure.

9. Capacity: Maximum 340 kg. (750 lbs.) operating load.
10. Lifting Height: (to suit) (3658 mm/144" maximum).
11. Travel Speed: 3.35 meters/minute (11 feet per minute).
12. Motor:
 - 0.75 H.P Motor: 208-240 VAC, 60Hz., 8 amp, single phase with minimum 1750 RPM instant reverse capability, for the 1041mm (41"), 1448mm (57") and 1829mm (72") lifting height.
 - 1 HP Motor: 208-240 VAC, 60 HZ, 9 amp, single phase with a minimum 1750 RPM instant reverse capability for the 2438mm (96"), 3048mm (120") and 3658mm (144") lifting height.Lift shall stop automatically at desired landings.
13. Platform and Mast Panel color: RAL #7030 - Stone Grey. (Optional RAL colors are available from Manufacturer).
14. Flush mount doors: 2032mm (6'8") with self-closers at the lower and middle (optional) landings and (specify) 2032mm (6'8") flush mount door or 1069mm (42") gate with self-closer at upper landing. Fire doors and Garaventa Style doors, are optional, and to be selected.
15. Side guard panels: 1070 mm (42 1/8") on platform.
16. Safety Devices:
 - a) Platform lighting integral to the platform control panel, automatically activated during travel and for at least 8 seconds after platform arrives at the designated landing.
 - b) Grounded electrical system with upper, lower, and final limit switches and 24 VDC operating controls.
 - c) Non-slip platform and access ramp surfaces.
 - d) Security key-locks on controls.
 - f) Solenoid activated interlock electrically monitors that the door is in the closed position and the deadbolt is engaged. The interlock cannot be defeated without special tools.
 - g) Integral safety nut assembly with safety switch.
 - h) Emergency stop switch shuts off power to lift and activates audio alarm.
 - i) Pit stop switch mounted on the shaftway wall (optional).
 - j) Battery powered emergency lighting.
 - k) Battery powered emergency alarm.

2.02 APPLICABLE STANDARDS

Lift shall be designed and manufactured in accordance with the following standards:

- 1) ASME A17.1 "Safety Code for Elevators and Escalators", Part XX (Commercial Public Buildings) or ASME A18.1 "Safety Standard for Platform Lifts and Stairway Chairlifts."
- 2) CSA-B355 "Lifts for Persons with Physical Disabilities."
- 3) ANSI A117.1 "Providing Accessibility and Usability for Physically Handicapped People."
- 4) NFPA No 70 National Electric Code.
- 5) CSA testing for mechanical and electrical equipment.
- 6) _____ Building Code.

2.03 ELECTRICAL SYSTEMS**WIRING:**

Electrical contractor shall provide electrical piping and wiring. Lift contractor will make final electrical connections.

CONTROLS:

24VDC constant pressure directional buttons on platform and On/Off key switches at landings and on platform. Emergency stop on platform.

Note: If the Genesis vertical lift has the keyless option, the key switches are removed from all call stations and the platform control panel.

(3) **INCLINATOR COMPANY OF AMERICA**
(SPECTRALIFT AND INCLINATOR VL LIFTS)

The *SpectraLift* cantilevered platform lift design manufactured by Inclinator was not installed in any of the courtrooms reviewed during the Analysis.

The most significant feature of the standard unit is the total integration of fiberglass cladding on all enclosure panels to provide adequate protection for outdoor use.

The basic drive mechanism and platform are similar in design to other cantilevered platform lift design concepts. (The only exception is the use of a hydraulic leaf chain drive to provide platform movement.)

The *Inclinator VL* unit basic framework and drive mechanism could possibly be adapted to the courtroom environment without the fiberglass enclosure.

[Elevators ▲](#)
[Stair Lifts ▲](#)
[Vertical Lifts ▲](#)
[Dumbwaiter ▲](#)
[Dealer Support ▲](#)
[Contact Us ▲](#)
[Literature ▲](#)
[Architect Support ▲](#)
[Press Kit ▲](#)

Vertical Lift Styles

SpectraLift | Inclinator VL

SpectraLift™

VERTICAL LIFT

General Information

Specifications
SpecData
ManuSpec

Specifications

Dimensions:

Tower: 11" x 43" x 81"

Platform: 36" x 51" x 42"

Toe Guard: 50" x 58" x 61"

Total Footprint: 59" D x 58" W

Material:

Platform, tower & ramp: Rust-free, fiberglass, non-skid surface
Internal components: Steel with anti-rust primer

Bridge Optional:

Polished aluminum, non-skid surface

Color:

Twenty pre-mixed standard colors, custom colors available

Capacity:

750 pounds

Lift:

54 inches

Motor:

24 VDC

Power:

Two 12 volt, 33AH sealed maintenance-free batteries, in series and charged with automatic 115 VAC powered, 24 VDC 10 Amp battery charger, with automatic charger switches that charge rates to maintain full service capacity



Platform interior



Control panel

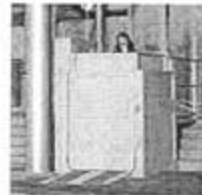

Operating SpectraLift



Optional Bridge

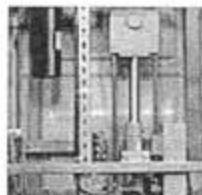

Drive System

Full Service Capacity**Drive:**

Two 7500 lb. tensile strength leaf chains, single stage constant displacement sealed hydraulic cylinder 1 GPM, and a 1250 PSI pump, providing a lift speed of 20 feet per minute

Control Switches:

24 VDC up-down switches with constant pressure and key operation

Safety Devices:

Slack chain safety device stops unit in the down direction in the event that the leaf chain becomes slack. Units without toe guard (enclosure) will have a diaphragm mounted beneath the platform, which will shut down the lift if an obstruction is encountered.

Manual Operation:

Operational in down direction

Ramp:

40 inches, non-skid, stationary

Hand Rail:

One ADA-compliant, stainless steel grab bar mounted on platform

Consult your local codes before ordering

Warranty

5-year warranty on all parts (excluding batteries); 2-year unconditional and an additional 3-year based on extended warranty via service contract with certified dealer. Labor not included.

[▲ BACK TO TOP](#)

Inclinator Company of America

INCLINATOR
COMPANY OF AMERICA

1. Product Name

- Inclinator SpectraLift™ Wheelchair Lift
- Inclinator® VL Wheelchair Lift

2. Manufacturer

Inclinator Company of America
P.O. Box 1557
2200 Paxton Street
Harrisburg, PA 17105
(800) 343-9007
(717) 234-8065
Fax: (717) 234-0941
E-mail: isales@inclinator.com
www.inclinator.com

3. Product Description

BASIC USE

Since 1923, Inclinator Company of America has been the pioneer in the development of air lifts and remains a leader in the residential elevator and vertical lift markets.

The Inclinator SpectraLift™ and Inclinator® VL vertical wheelchair lifts offer people with physical limitations an answer to stairs. They are ideal for indoor and outdoor applications such as schools, churches, meeting halls, boat docks, amusement parks, stadiums, offices and homes.

Inclinator SpectraLift Wheelchair Lifts

SpectraLift is a new vertical lift from the ground up. This unit consists of a platform, tower and ramp, sealed hydraulic lifting mechanism and Inclinator's newest drive system. The unit's fiberglass construction eliminates the rattling noise sometimes heard on metal units.

SpectraLift is available with a toe guard enclosure designed to comply with ANSI/ASME A17.1 Section 2000.1 B. The toe guard's optional features include a self-closing, lower landing gate, platform gate and upper landing gate. These lifts offer flexible installation and servicing options, emergency manual lowering capabilities and emergency stop, alarm, key switch and other safety features.

ADVANTAGES

SpectraLift

- 24 VDC up-down switches with constant pressure and key operation
- Slack chain safety device
- ADA compliant grab bar mounted on platform
- Manual operation in down direction

Inclinator VL Wheelchair Lifts

Inclinator VL is manufactured from steel with a weather resistant coating and is adaptable for indoor and outdoor usage. It is designed for quiet operation and easy installation and service. It features an emergency stop, alarm and keyswitch and offers 750 lb (341 kg) capacity, a standard 12 ft² (1.1 m²) platform and travel distance of 12 (3.7 m).

OPTIONAL EQUIPMENT

SpectraLift Wheelchair Lifts

- Bridge of polished aluminum with nonskid surface up to 5' (1524 mm)

Inclinator VL Wheelchair Lifts

- 15 ft² (1.4 m²) platform
- 42" (1067 mm) high platform gate
- 42" (1067 mm) high landing gate
- Auto-fold ramp
- Stationary ramp at lower landing
- 90 degree exit

COMPOSITION & MATERIALS

The SpectraLift platform, tower and ramp are constructed of rust-free fiberglass with a non-skid surface. Internal components are made of steel and treated with an antirust primer.

The Inclinator VL platform is fabricated from 16 gauge carbon steel with a weather resistant, baked-on, standard beige powder coating.

COLORS

The SpectraLift is available in 20 premixed standard colors and custom colors can be ordered. The Inclinator VL is available in beige only.

SIZES

SpectraLift

- Tower - 11" x 43" x 81" (279 x 1092 x 2057 mm)
- Platform - 36" x 51" x 42" (914 x 1295 x 1067 mm)
- Toe guard - 50" x 58" x 61" (1270 x 1473 x 1549 mm)
- Total footprint - 59" (1499 mm) deep x 58" (1473 mm) wide
- Ramp - 40" (1016 mm)



Inclinator's SpectraLift™ is the industry's only fiberglass wheelchair lift.

Inclinator VL

- Platform - Offered in a standard 12 ft² (1.1 m²) size 36" x 48" (914 x 1219 mm) usable space, with a 15 ft² (1.4 m²) option for 36" x 60" (914 x 1524 mm) usable space

ELECTRICAL

SpectraLift is powered by two 12 V 33AH sealed maintenance-free batteries and charged with an automatic 115 VAC powered, 24 VDC, 10 amp battery charger with automatic charge rates to maintain full service capacity.

Inclinator VL uses an ACME screw powered by a 1 hp, 60 hz, 1 phase 110 V instant reversing motor.

LIMITATIONS

Use and installation of these systems are design dependent. Do not exceed rated load capacity. Consult manufacturer for more information.

4. Technical Data

APPLICABLE STANDARDS

American National Standards Institute/American Society of Mechanical Engineers - ANSI/ASME A 17.1 Parts XX and XXI, 1996 Edition

ENVIRONMENTAL CONSIDERATIONS

Metal components are presumed to be recyclable upon final disposition.

APPROVALS

Contact manufacturer for information on approvals by industry entities.



Inclinator Company of America

PHYSICAL/CHEMICAL PROPERTIES

The SpectraLift has a 750 lb (341 kg) lift capability and a 54" (1372 mm) lift height. The drive system consists of two 7500 lb (3405 kg) tensile strength leaf chains, a single stage constant displacement sealed hydraulic cylinder, a 1 gpm (0.063 L/s) and a 1500 psi (10,343 kPa) pump, providing a lift speed of 20' (6 m) per minute.

The Inclinator VL is designed to meet or exceed ANSI A17 requirements. It has a 750 lb (341 kg) lift capability. VL lifts are capable of travel distances up to 12 (3.7 m).

Test reports and additional technical and product information are available to design professionals upon request.

5. Installation

PREPARATORY WORK

Handle and store product components according to Inclinator Company of America recommendations. Furnish labor, materials and equipment necessary or required to fully complete the installation of the wheelchair lift as indicated on the drawings and in the specifications. Shop drawings should show complete layout of lifting equipment, detailing dimensions and clearance. Loads and reactions will be provided by the manufacturer.

Provide a 120 VAC, 20 amp dedicated service with lockable disconnect. Provide a level mounting surface of minimum 4" (102 mm) thick, 3000 psi (20,670 kPa) concrete.

To install the platform flush with the ground, a 3" (76 mm) pit is required. A ramp is required if the unit will sit flush to the ground.

METHODS

Jobsite dimensions should be taken to ensure that tolerances and clearances have been maintained and meet local regulations. Inspect the construction and service requirements for work by others. These requirements will be included in drawings, diagrams, engineering data sheets and special instructions before the work commences.

Installation of all components of the wheelchair lift should be carried out by an authorized installer, in accordance with the installation and operating instructions provided by the manufacturer. Complete installation recommendations are available from Inclinator Company of America.

PRECAUTIONS

Supports and all structural framing must be properly designed and installed to resist imposed loads. Normal terminal stopping devices should be located at the top and bottom of the hoistway to stop the car automatically. All limit switches and leveling devices should be inaccessible to unauthorized persons. Wiring and electrical connections must comply with applicable codes.

After installation, and before general use, verify the following:

- Lift will not operate with any door/gate open
- Doors/gates will not open when the lift is not at the landing
- Safety pan will stop the downward travel of the lift by using a stick or other object to reach under the unit and push up on the pan at several locations
- Emergency stop/alarm button stops unit and sounds alarm
- Final limit prevents operation in either direction by depressing the roller lever
- Flip up ramp rises to approximately 45 degrees and holds as lift travels upward
- Unit will not run unless key is in "on" position

BUILDING CODES

Current data on building code requirements and product compliance may be obtained from Inclinator Company of America technical support specialists. Installation must comply with the requirements of all applicable local, state and national code jurisdictions.

6. Availability & Cost

AVAILABILITY

Inclinator Wheelchair Lifts are available through a network of authorized National Inclinator of America Dealers. Contact manufacturer for more information.

COST

Installed cost will vary by specific installation. Budget installed cost information may be obtained from the manufacturer.

7. Warranty

For SpectraLift, Inclinator Company of America offers a 5 year warranty on all parts (excluding batteries); 2 year unconditional and an additional 3 year based on extended warranty via service contract with certified dealer. Labor not included. For Inclinator VL, Inclinator Company of America offers a war-

ranty of 1 year on parts only. For more information on warranty conditions, duration and remedies, contact the manufacturer.

8. Maintenance

A service contract with the installer is recommended. Routine inspections and tests should be conducted per the guidelines in ANSI/ASME A17.1, Rules 10.10.2 and 10.10.10 for residential and commercial applications, or A18.1, Section 10. An authorized National Inclinator Company of America Dealer should complete planned maintenance at least every 6 months. Additional maintenance requirements, including the items to be serviced and how often, may be obtained from the manufacturer.

9. Technical Services

The manufacturer offers technical support to the specifier regarding equipment specifications, product warranties and cost estimates. For technical assistance, contact Inclinator Company of America.

10. Filing Systems

- CMD First Source
- MANU-SPEC™
- Sweet's Catalog Files
- Additional product information is available from the manufacturer upon request.



[Home](#)
[Elevators ▲](#)
[Stair Lifts ▲](#)
[Vertical Lifts ▲](#)
[Dumbwaiter ▲](#)
[Dealer Support ▲](#)
[Contact Us ▲](#)
[Literature ▲](#)
[Architect Support ▲](#)
[Press Kit ▲](#)
VERTICAL LIFT STYLES: [Spectralift](#)...[Inclinor_VL](#)

Inclinor®VL

VERTICAL LIFT

The Inclinor VL eliminates the problems that stairs cause people with physical limitations. Perfect for churches, schools, meeting halls, offices and homes.

- * 16 gauge carbon steel with weather resistant coating
- * Adaptable for indoor and outdoor usage
- * Easy installation and service
- * Emergency stop, alarm and keyswitch
- * 750 lb. capacity
- * Standard 12 sq. ft. platform (15 sq. ft. option)
- * Up to 12' travel distance
- * CSA approved

Consult your local codes before ordering



▲ [BACK TO TOP](#)

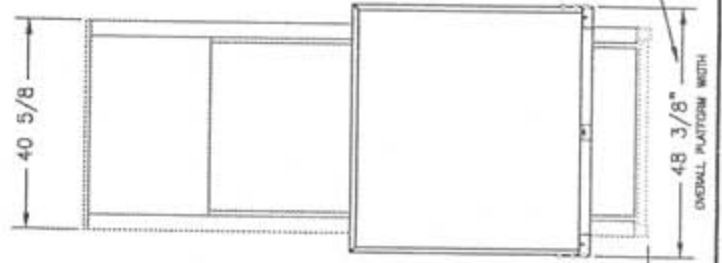
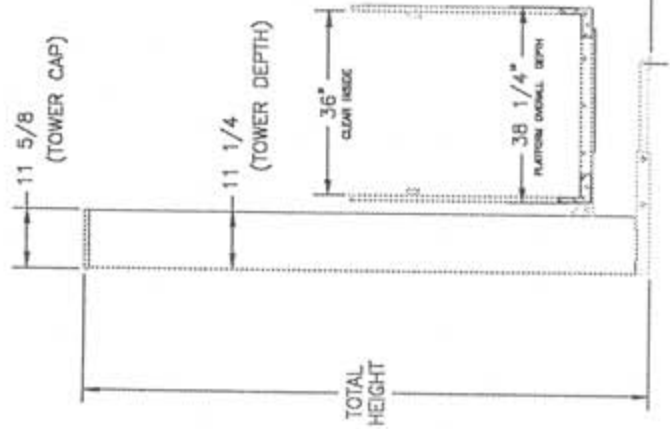

UNIT SIZE	TOTAL HEIGHT
4 ft	80 1/2"
6 ft	104 1/2"
8 ft	128 1/2"
10 ft	152 1/2"
12 ft	176 1/2"

NOTE: ALL DIMENSIONS ARE INCHES AND ARE FOR REFERENCE ONLY.

INCLINATOR
 COMPANY OF AMERICA
 HARRISBURG, PA

TITLE: LIFTETTE DIMENSIONS
 48" THRU CAR
 DATE: 4/26/99
 DRAWN BY: BW/W

REFLECTS THE ADDITION OF L-BRACKETS ON EACH END OF PLATFORM

FIND NO.	PART NO.	DESCRIPTION	QTY. REQ.
1	LFT-249	BOLT ANCHOR, 1/2 x 5-3/4	4
2	LFT-200	SPRING PIN, 1/2 x 2 1/2	4

MOUNTING INSTRUCTIONS (concrete floor)

1. SECURE EXTENSION FEET TO FRAME USING THE 1/2 x 2-1/2 SPRING PINS. PINS MUST BE FLUSH WITH THE SIDES OF THE 2-1/2" SQ. TUBE .
2. THE FRAME SHOULD BE ANCHORED AFTER THE CAR IS INSTALLED AND POSITIONED FOR PROPER CLEARANCE OVER THE FULL TRAVEL OF THE CAR.
3. DRILL FOUR 1/2" DIAMETER HOLES, A MINIMUM OF 3-3/4" DEEP, (INTO CONCRETE) THROUGH THE FRAME IN THE LOCATIONS SHOWN.
4. DRIVE THE BOLT ANCHORS THROUGH THE FRAME UNTIL THE BOLT HEAD IS FIRMLY SEATED AGAINST THE FRAME.
5. TIGHTEN BOLTS TO 60 ft-lbs (APPROX. 3-4 TURNS).

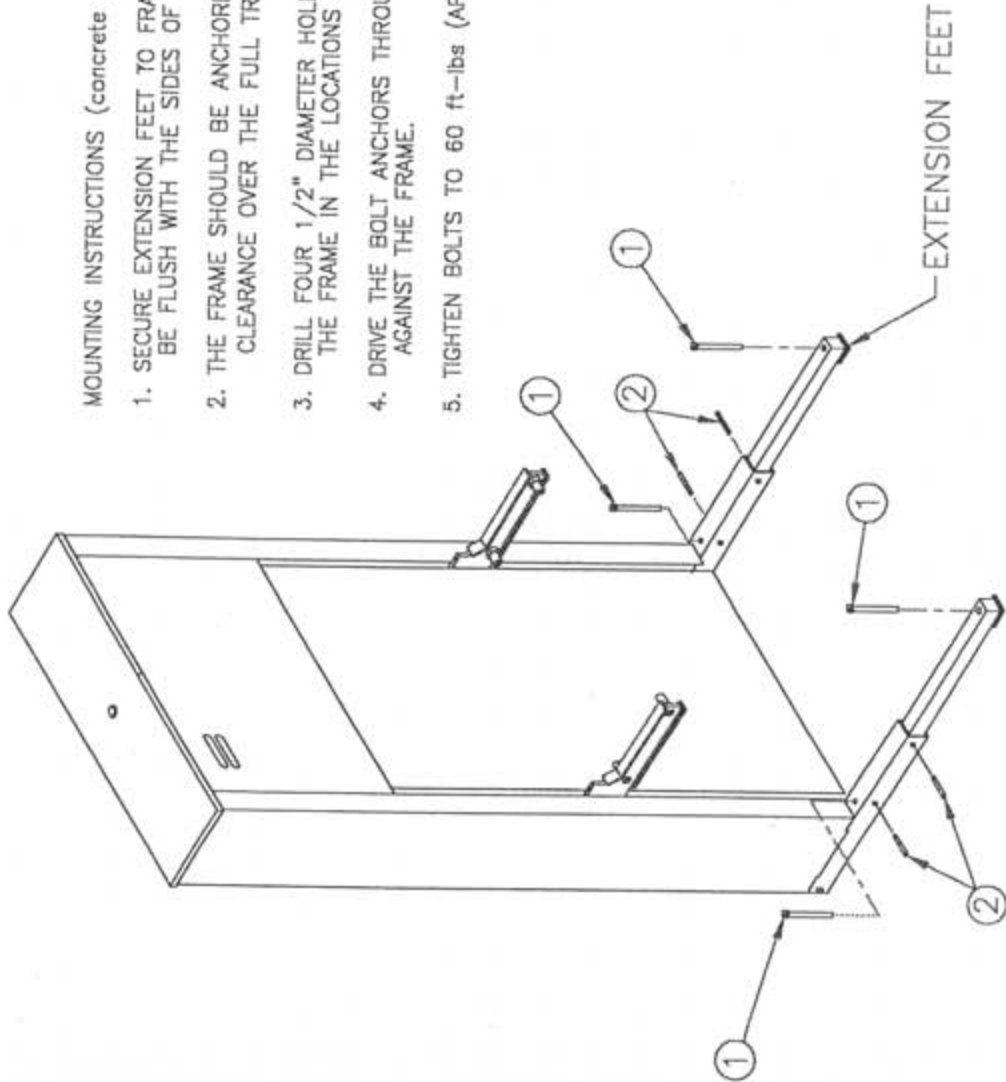

INCLINATOR
 COMPANY OF AMERICA
 HARRISBURG, PA

TITLE

MOUNTING HARDWARE
 (4 & 6 ft. Towers)

DVN. BY

BWW

DATE

7/8/99

SCALE

REV. DATE

ECN

DESC.

REVISIONS

DW. BY

PART NO. LFT-251-1

(4) **ACCESS INDUSTRIES**
(PORCH-LIFT)

This self-contained unit is clad with metal panels to allow versatility in use both indoors and outdoors. The *Porch-Lift* provides a cantilevered platform lift with a re-circulating ball screw, or a rope hydraulic system as the two drive mechanism options.

An older model of this unit, located at the Maricopa County Courthouse in Phoenix, Arizona, was reviewed as part of the Analysis. (The unit was not in operation due to provision of other means for accessibility by the physically disabled, incorporated as part of the recent building renovation.)



Porch-Lift Residential

For personal use, a residential model makes it easier to enter and exit your home.

Porch-Lift Standard

The most popular vertical platform lift for custom designs.



Porch-Lift Toe Guard

Stationary lower landing walls and gate shield the underside of the platform as the platform rises.

Porch-Lift Portable

For temporary access at a moments notice, the Portable Vertical Platform Lift is the answer!

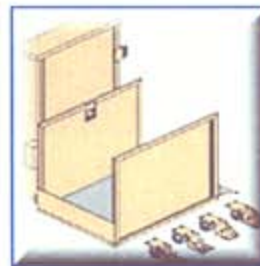

[| Home](#) | [| About Us](#) | [| Careers](#) | [| Architect Support](#) | [| Contact Us](#) |
[| Stairway Lifts](#) | [| Vertical Platform Lifts](#) | [| Inclined Platform Lifts](#) |
[| Elevators](#) |

©2001 Access Industries webmaster@accessind.com

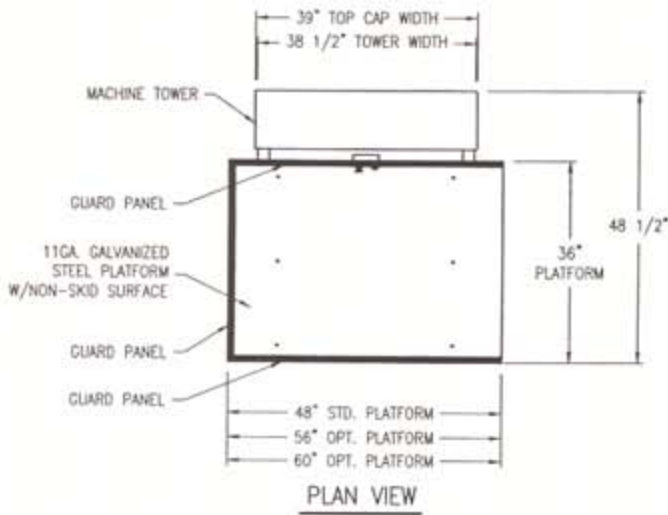

PLAN VIEW

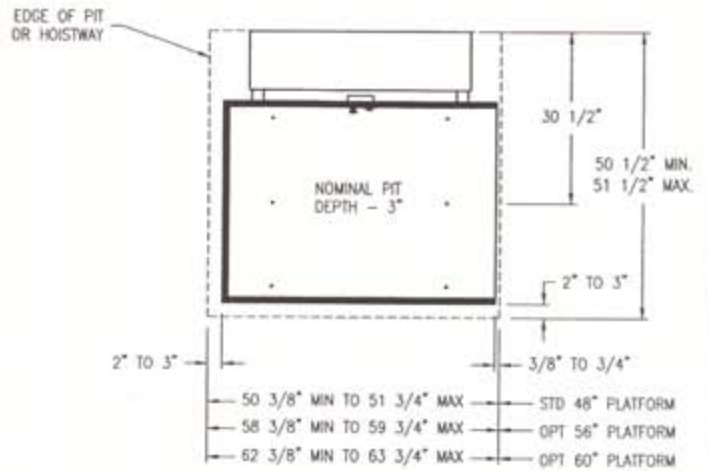

HOISTWAY OR PIT LAYOUT

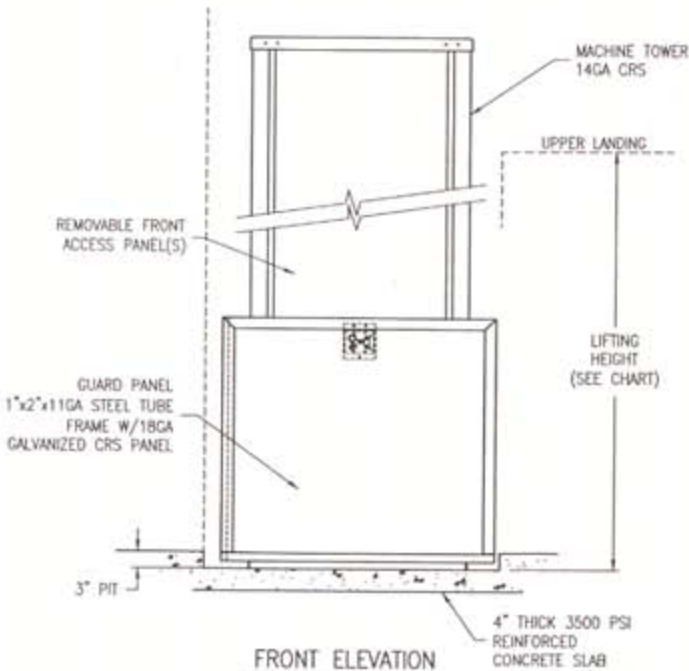

FRONT ELEVATION

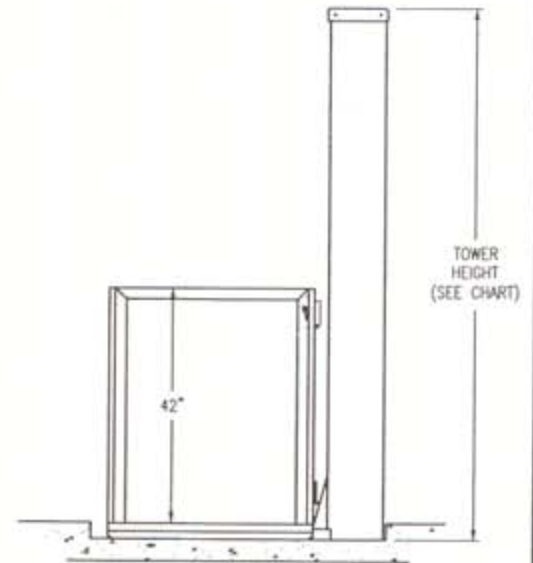

LOWER LANDING SIDE ELEVATION

MODEL	Max. Lifting Ht.	Tower Height
96	99"	119.25"
120	123"	143.25"
144	147"	167.25"
168	171"	191.25"

			MODEL:		
			DEALER:		
			CUSTOMER:		
			JOB or P.O.#:		
SCALE:		DATE:		ORDER NUMBER:	
NTS		10/25/00		PL-S 03	

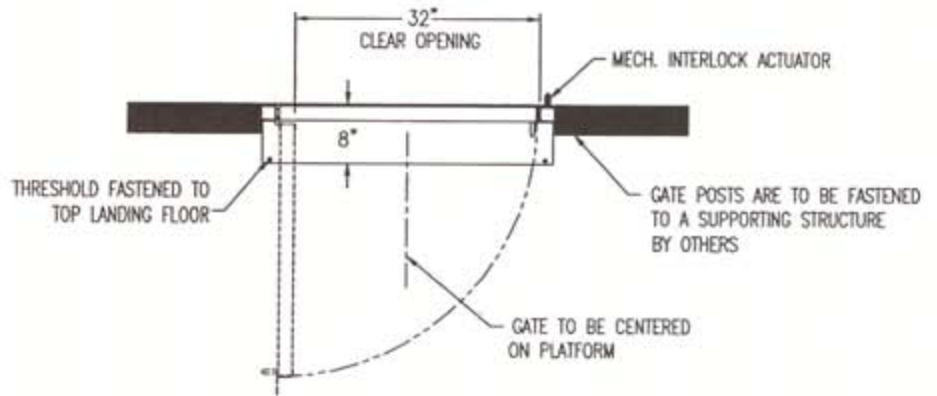

PLAN VIEW

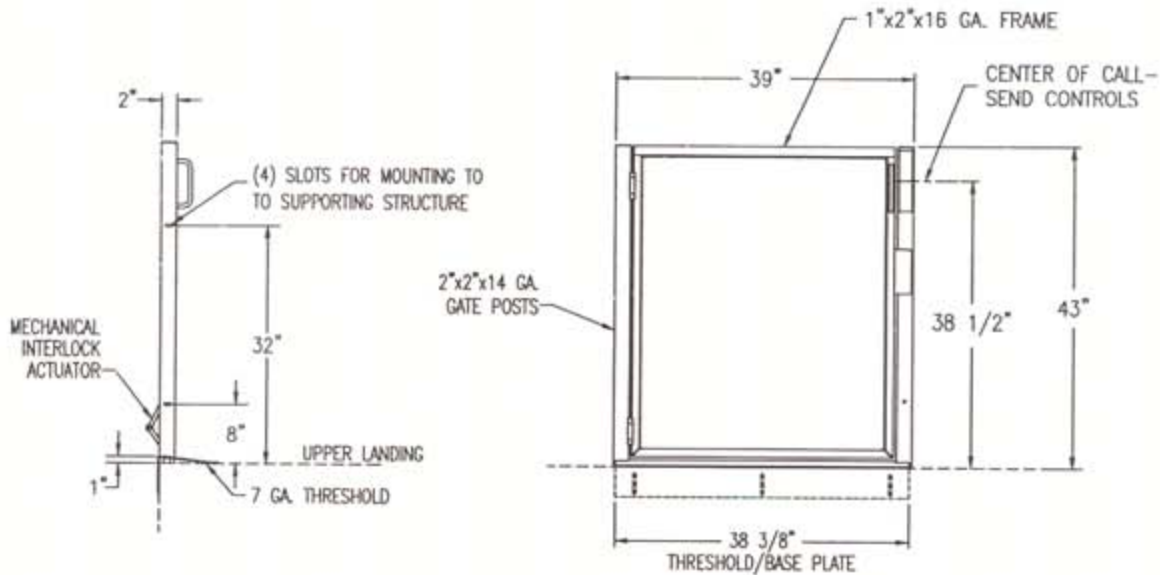

SIDE VIEW

FRONT VIEW

GATE OPTIONS	
<input type="checkbox"/>	22 GA. STEEL DOOR PANEL
<input type="checkbox"/>	CLEAR ACRYLIC DOOR PANEL
<input type="checkbox"/>	BRONZE TINTED ACRYLIC DOOR PANEL
<input type="checkbox"/>	CALL/SEND CONTROLS MOUNTED IN GATE POST
<input type="checkbox"/>	AUTOMATIC OPENER/CLOSER

 <p>ACCESS INDUSTRIES, INC. 4001 East 138th Street Grandview, MO 64030-2837</p>	MODEL:	
	DEALER:	
	CUSTOMER:	
<p>PORCHLIFT. VERTICAL PLATFORM LIFT 39" Landing Gate 32" Clear Opening</p>	JOB or P.O.#:	
	SCALE:	DATE:
	NTS	01/28/99
		ORDER NUMBER: GATE-02

Access Industries - Porch-Lift® Vertical Platform Lifts - Model PL-S

PART 1 - GENERAL

1.01 DESCRIPTION OF PRODUCT

A vertical platform (wheelchair) lifting device, manufactured by Access Industries, designed to provide access to or within a building for mobility impaired persons. The lift consists of machine tower and lifting platform selected and dimensioned to provide adequate lifting height to suit building access requirements indoors and outdoors. The lift shall have capacity to lift 750 lbs. (340 kg) to lifting height of 171 inches maximum when anchored on level, 4" (102mm) thick 3500 psi (241 MPa) concrete pad.

1.02 QUALITY ASSURANCE

The lift shall be designed, tested and installed in compliance with applicable regulations of all governing agencies with jurisdiction and in accordance with ASME-A18.1 (formerly A17.1: Part XX, Section 2000, Rule 2000.1a for elevators in buildings) and ADAAG compliant. All load ratings and safety factors shall be certified by a professional engineer. Lift shall be subject to applicable state and city approval prior to installation and subject to inspection after installation. Submittals: Lift contractor will submit drawing and (or) manufacturer's approval. Drawings shall show rough-in and wiring requirements. Substitutions: No substitutions will be considered unless written request for approval has been submitted by the bidder and received by the architect 10 days prior to the date of receipt of bids.

PART 2 - PRODUCT

2.01 MANUFACTURER/EQUIPMENT

The lift shall be the PORCH-LIFT® PL-S Model with maximum lifting height (specify:) 39" (ballscrew only), 53", 75", 99", 123", 147" or 171" (990mm, 1395mm, 1905mm, 2514mm, 3124mm, 3733mm or 4343mm) and a platform size of 36" x 48" (914mm x 1219mm),

36" x 56" (914mm x 1422mm) or 36" x 60" (914mm x 1524mm) manufactured by Access Industries, Grandview, MO, (816) 763-3100, FAX (816) 763-3100.

1. Capacity: 750 lbs. (340 kg) with minimum safety factor of 5X.

2. Travel Speed: 15 fpm (.08 m/s) maximum. Lift shall stop automatically at all landings.

3. Drive: (Specify)

A. Recirculating Ball Screw, 115 V, 60 Hz, 7.6 amp single-phase motor with minimum 1/2 hp, 1725 rpm instant reverse capability. Ball bearing drive system, three groove pulleys with matched multi-V-belt and a broken belt system.

B. 1:2 Roped Hydraulic, full time 24V Battery Operation and dual stage Charge system.

4. Static Load Test: All load ratings and safety factors shall meet or exceed those specified in ASME-A18.1 for public buildings and shall be certified by a professional engineer.

5. Independent Laboratory Testing: The lift shall have been tested by a recognized Laboratory to conform to ASME-A18.1, and carry the UL Label.

Fabrication/Components:

1. Machine Tower: 14 ga. steel sheet.
2. Base Frame: 2" x 2" x 1/4" (51mm x 51mm x 6mm) structural steel angle.
3. Lift Weldment: 3/8" (9.5mm) hot rolled steel plate and 2" x 2" x 1/4" (51mm x 51mm x 6mm) wall structural steel tubing.
4. Tower Cap: Heavy gauge steel sheet.
5. Side Guard Panels: 18 ga. steel sheet panel in 1" x 2" x 14 ga. (2" x 14 ga.) steel tubing frame.
6. Front Panel: 20 ga. steel sheet.
7. Platform: 11 ga. galvanized steel plate; slip resistant surface.
8. Access Ramp: 11 ga. galvanized steel plate; slip resistant surface
9. All Welded Parts: welders certified in accordance with requirement D1.1.
10. Coatings/Surfacing: Lift shall be finished by the following process: detergent wash, clear water rinse, iron phosphate coating, clear water wash, chromate rinse, electrostatically applied thermosetting powder coat finish for indoor or outdoor use. Standard color is Ivory.

Controls and Safety Devices:

The lift shall have the following:

1. Platform Controls - 24 V on/off key switch, constant pressure directional switches, emergency stop switch. (option:) Attendant operated pack controls substituted for platform controls.
2. (option:) Landing Controls - on/off key switch and constant pressure call/send paddles. Call/Send controls shall be installed in upper landing gate/control panel.
3. Ball Screw Drive:
Integral ball screw safety device and electromechanical brake.
4. Hydraulic Drive:
Slack rope safety device.
Hydraulic flow control valve.
5. Grounded electrical system with upper, lower and final limit switch operating controls.
6. 42" (1067mm) high side guard panels, and non-slip platform and landing surfaces.
7. Security key locks at controls for limited access to meet requirement A18.1.
8. Platform underpanel equipped with obstruction sensitive cut-out switches.
9. (option:) 42" (1067mm) self-closing gate with VDR™ Mechanical Interlock to be provided at top landing and/or 6'8" (2032mm) flush mount 1-1/2" high door with self-closure and VDR™ mechanical interlock. VDR™ mechanical interlocks allow platform ascent/descent only when gates/doors are locked.
10. (option:) Grab rail on platform for rider security.
11. (option:) Signaling device shall provide audio alarm that can be activated from platform or landings when emergency assistance is required.
12. Hand wheel manual lowering device on ball screw drive (or) emergency stop switch.

lowering valve on hydraulic drive to lower platform in event of power failure.

Applicable Standards: Lift shall be designed and manufactured in accordance with the following standards:

1. American Society of Mechanical Engineers (ASME)
2. Underwriters Laboratories (UL)
3. ADA Accessibility Guidelines (ADAAG)
4. National Building Code (BOCA)
5. National Electrical Code (NEC)
6. American Society for Testing Materials (ASTM)
7. American Welding Society (AWS)

2.02 ELECTRICAL SYSTEMS

Wiring: The electrical contractors shall provide a 115V, single phase electrical power source connection.

PART 3 - EXECUTION

3.01 INSTALLATION

Lift shall be installed in accordance with manufacturer's instructions specified and approved by architect. Lift contractor shall provide and install all specified lift components. Landing gates and doors shall be installed by others. Electrical piping and wiring by others. Final electrical connections and adjustments by lift contractor. Lifts subject to local, city and state code requirements. Specification is to broadly outline equipment required but does not cover design and construction.

Codes: All designs, clearances, workmanship and material, unless specifically noted, shall be in accordance with all codes having legal jurisdiction in the project area. Compliance with all applicable inspection requirements. Determining adherence to these regulations is the responsibility of the lift contractor.

Maintenance: Lift must be maintained in accordance with manufacturer's instructions.

Warranty: Basic lift components shall carry a one year limited warranty. Landing gates shall carry a two year limited warranty.

Note: Dimensions and specifications are subject to constant change due to evolving codes and product applications. For additional technical information, contact Access Industries, at (800) 925-3100.

(5) **THE NATIONAL
WHEEL-O-VATOR COMPANY**

This manufacturer provides cantilevered platform; portable; and inclined platform lifts. The cantilevered platform lift is the product most suited for the courtroom environment. (A manufacturer's representative recommends against use of the portable lift in courtrooms because of size and maneuvering challenges.)

The cantilevered platform unit was installed in two of the courthouses visited as part of this Analysis. Platform surface and mechanical drive enclosure finishes have been adapted to the architectural design at both facilities.

Typically, the standard unit is provided with the controls and handrail mounted on a panel connected to the platform, located adjacent to the equipment tower.

In checking with the manufacturer, it is possible to provide service access at the back of the drive mechanism tower. (This approach would have eliminated the need for an access panel in the granite wall at the Las Vegas Courthouse courtrooms.)

The mechanism tower can be custom designed to a minimum height of 45 in. Pit depth required is typically 3 in. and the drive mechanism is an Acme screw system.

Section 2

Vertical Lift Section Specifications

Reference:	Material Contained
2.0	Vertical Lift Code Summary
None	Brochure
2.1	Model BC Basic Commercial Vertical Lift Acme Screw Drive For installation in a runway by others or as an unenclosed lift when allowed by code authorities
2.2	Model HBC Basic Commercial Vertical Lift Self-Contained DC Hydraulic Lift Drive For installation in runway by others or as an unenclosed lift when allowed by code authorities
2.3	Model BC Portable Vertical Lift Acme Screw Drive
2.4	Intentionally Blank
2.5	Model CDE Commercial Vertical Lift Acme Screw Drive With metal enclosure (runway) by National Wheel-O-Vator
2.6	Model HCDE Commercial Vertical Lift Self contained DC Hydraulic Drive With metal enclosure (runway) by National Wheel-O-Vator
2.7	Model PCDE Commercial Vertical Lift Acme Screw Drive With metal enclosure (runway) frame with clear or tinted acrylic panels in enclosure by National Wheel-O-Vator
2.8	Model HPCDE Commercial Vertical Lift Self Contained DC Hydraulic Drive With metal enclosure (runway) frame with clear or tinted acrylic panels in enclosure by National Wheel-O-Vator
2.9	Model CR Courtroom Vertical Lift Acme Screw Drive
2.10	WOV355 Commercial Vertical Lift Brochure Elevator Style Lift Rail System Remote Hydraulic Machine Room, full size cab, install in runway by others Requires variance in most areas
2.11	Doors, Door Operators, Ventilation, Lighting

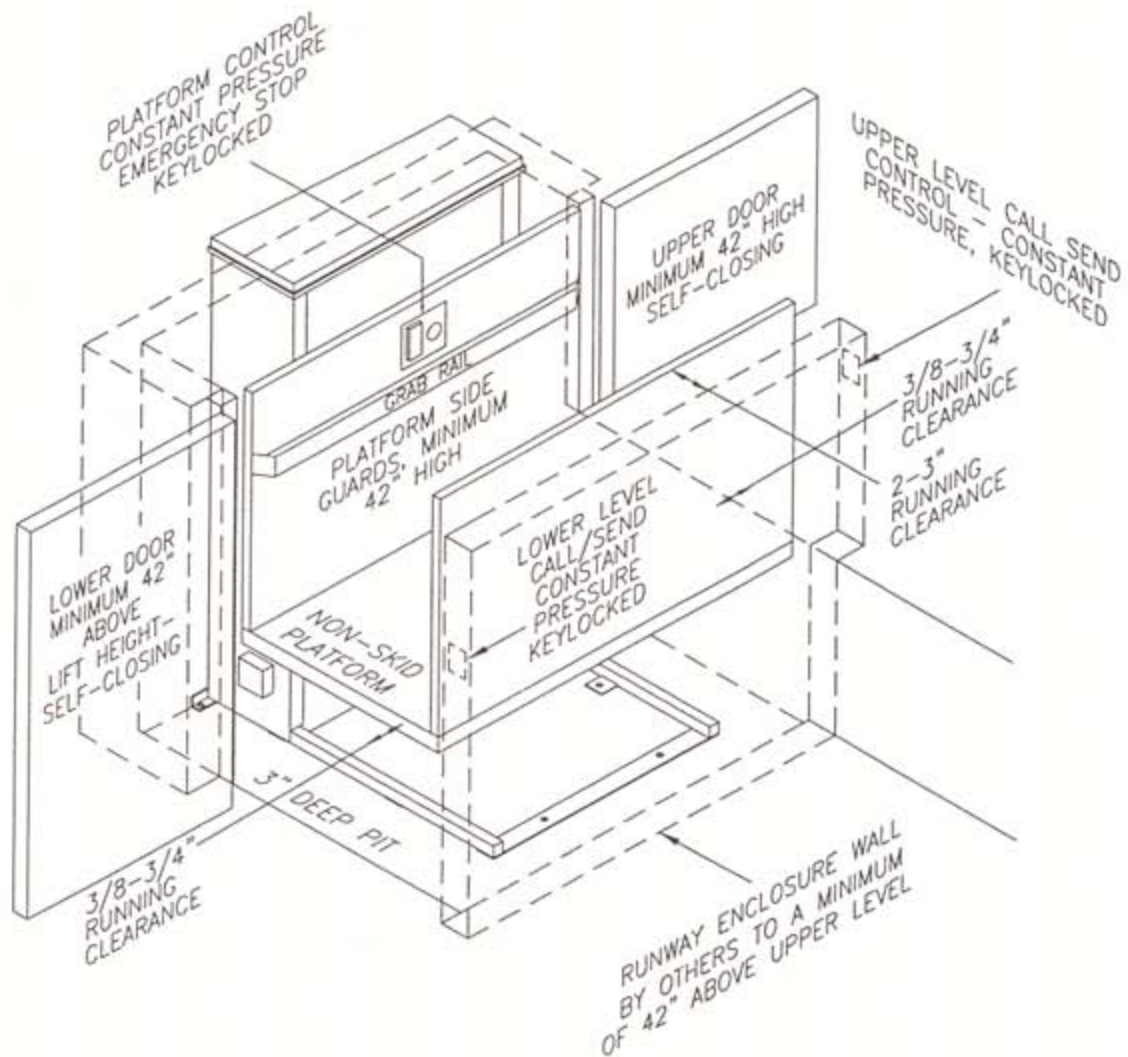

TYPICAL VERTICAL WHEELCHAIR LIFT

NOTE: VARIOUS UNLISTED CONDITIONS ARE REQUIRED FOR LIFT TO BE CODE COMPLIANT.

NATIONAL WHEEL-O-VATOR			
509 W. FRONT ST. ROANOKE, ILLINOIS 61561 800-551-9095			
SCALE:	DATE:	DRAWN BY:	DRAWING NUMBER:
40	4/00	AS	BC2
DESCRIPTION:			
TYPICAL VERTICAL PLATFORM LIFT			

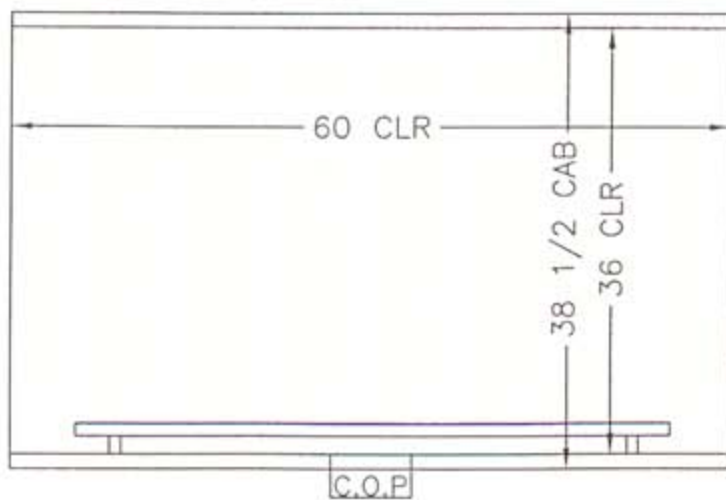
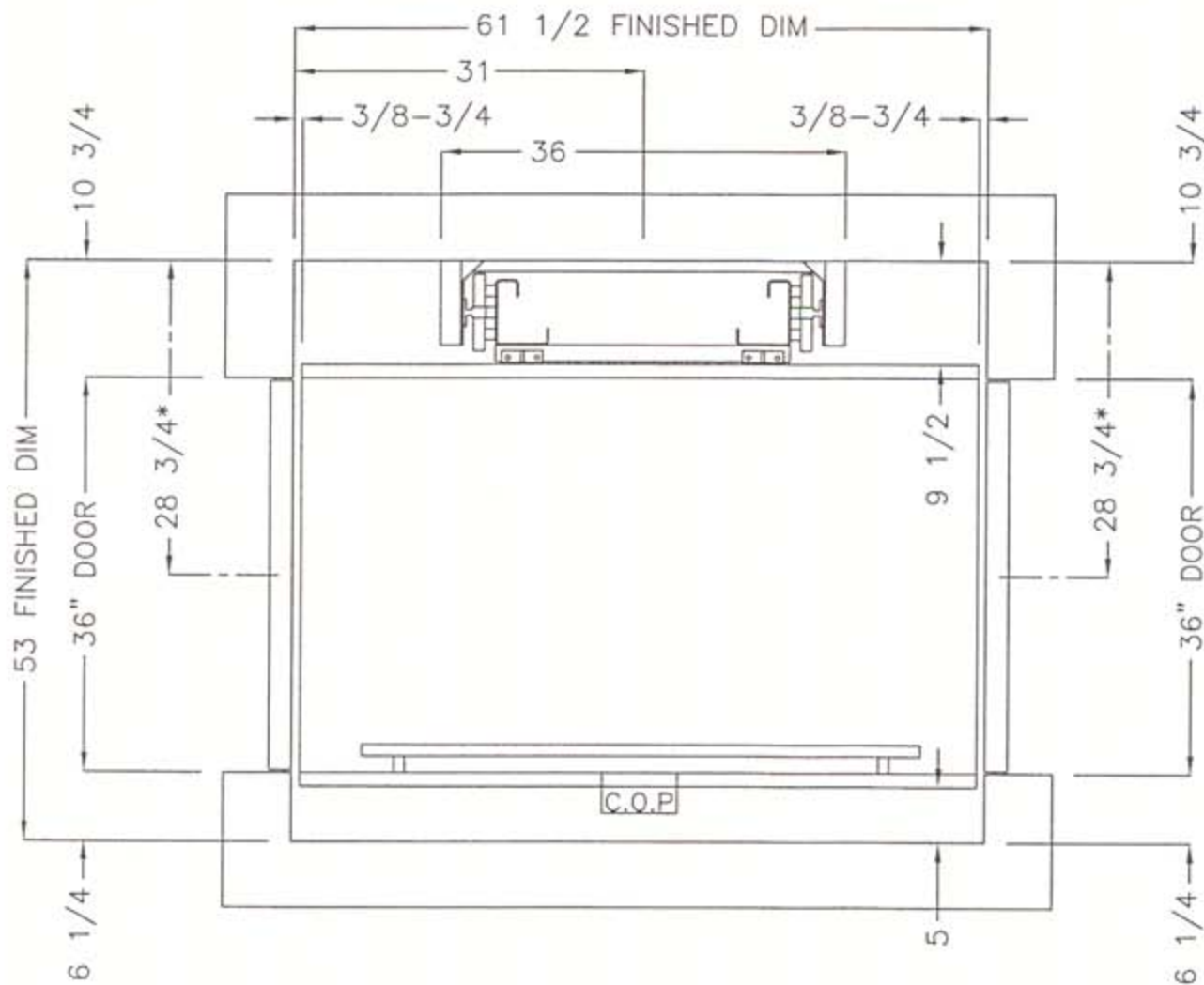

NOTES:

1) *-DIMENSION IS FOR A STANDARD 36" DOOR WITH AN ELECTRIC STRIKE INTERLOCK. FOR OTHER SIZE DOOR OR INTERLOCK TYPE, CONSULT FACTORY.

NATIONAL WHEEL-O-VATOR			
509 W. FRONT ST. ROANOKE, ILLINOIS 61561 800-551-9095			
2 OPEN/36X60			
WOV355			
SCALE: NONE	DATE: 4/10/98	DRAWN BY: AS	DRAWING NUMBER: WV-2006
DEALER:			
JOB:			

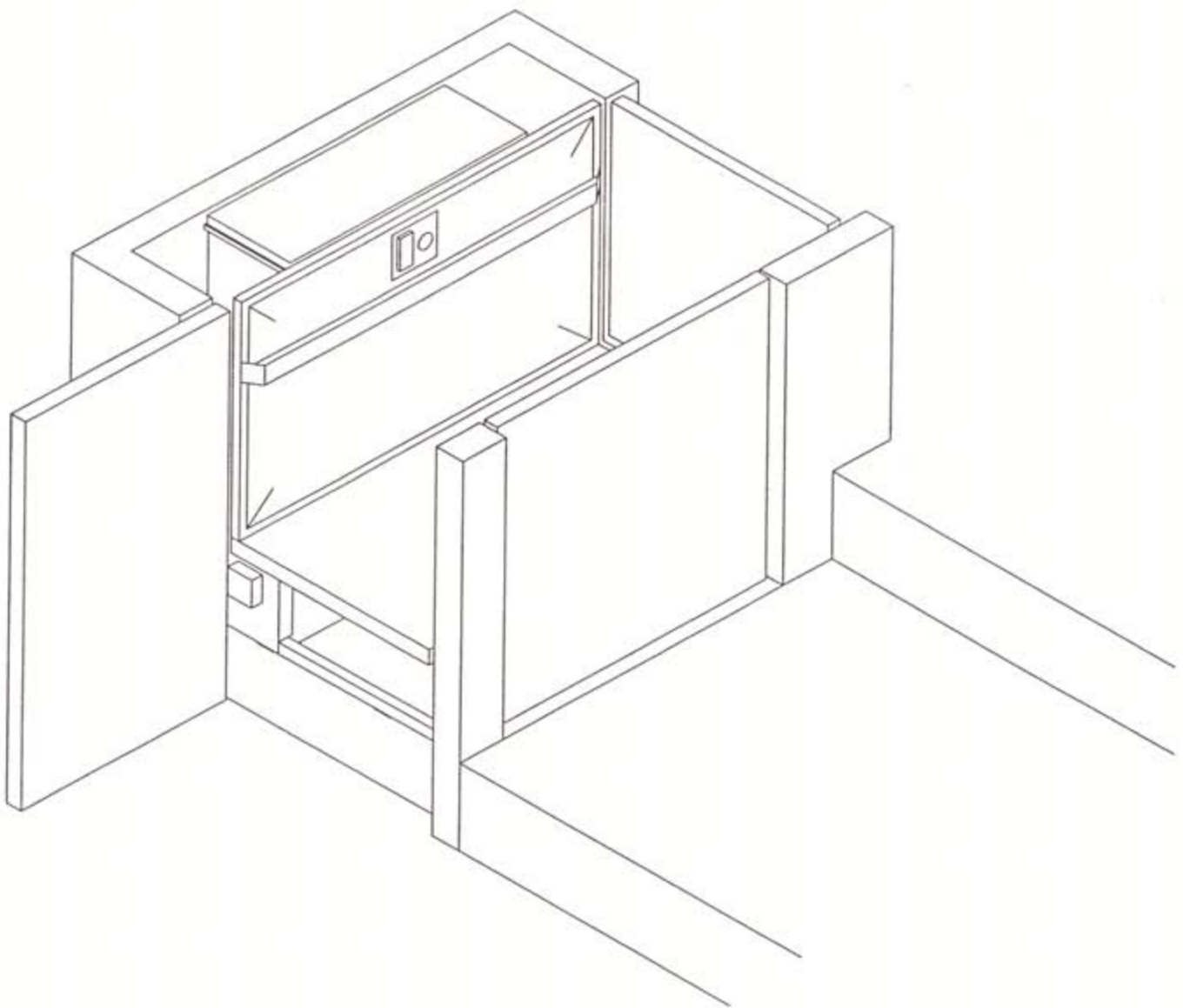

TYPICAL COURT LIFT APPLICATION

NOTE: VARIOUS UNLISTED
CONDITIONS ARE REQUIRED FOR
LIFT TO BE CODE COMPLIANT.

NATIONAL WHEEL-O-VATOR			
509 W. FRONT ST. ROANOKE, ILLINOIS 61561 800-551-9095			
SCALE:	DATE:	DRAWN BY:	DRAWING NUMBER:
NONE	11.3.00	AS	BCCOURTLIFT
DESCRIPTION:			
TYPICAL COURT LIFT APPLICATION			

(6) **ASCENSION**

Ascension provides only portable lift units. The typical design includes an enclosure comprised of a metal frame with clear thermoplastic panels. (Side or end panels can be hinged for access.)

A ramp is required to reach the platform at the lowest level.

Originally, the U.S. Courthouse at Tallahassee, Florida was intended to be one of the sites visited during the Analysis. An Ascension Portable Lift was provided at the courthouse but proved to be impractical. (The building design did not provide adequate clearance along the route of travel between, and within, courtrooms to accommodate the unit.)

The portable lift unit relies on hydraulic pressure for vertical movement.

TABLE OF CONTENTS (CONTINUED)

SECTION THREE

DETAILED ANALYSIS AND FINDINGS

SUMMARY	3-1
PROBLEM ISSUES	3-2
FEASIBLE EXISTING SYSTEMS	3-4
DESIGN ISSUES	3-5
CODES AND STANDARDS COMPLIANCE	3-8
INSTALLATION	3-8
OPERATION	3-9
MAINTENANCE	3-10
RECOMMENDED PROTOTYPICAL PLATFORM LIFT ACCOMMODATION	(ILLUSTRATION)
OCCUPANT CONTROL POSITIONING	(ILLUSTRATION)
INSTALLATION CONFIGURATIONS	(ILLUSTRATION)

SECTION FOUR

CONCLUSIONS AND RECOMMENDATIONS

SUMMARY	4-1
CURRENT FUNCTIONAL ISSUES	4-1
SYSTEM SELECTION	4-2
DESIGN CONSIDERATIONS	4-3
CODES AND STANDARDS COMPLIANCE	4-3
INSTALLATION	4-4
OPERATION	4-5
MAINTENANCE	4-5
CONCLUSION	4-6



Testimonials - NEW!

Lift Operation

ASCENSION PORTABLE WHEELCHAIR LIFT

**The Most Cost-Effective Way
to Access ALL of Your
Stages and Platforms**



**ISO9001:2000
COMPLIANT**

The Ascension portable wheelchair lift provides access to stages, platforms, and risers for individuals with disabilities. The portability makes it possible for public facilities to substantially reduce the exc costs of permanent access equipment or ramps since one lift can s multiple locations.

The Ascension portable wheelchair lift also provides for independence as required by the Americans with Disabilities Act (ADA).

Two models are available: the Ascension SLA-2050ED and the As SLA-2050ESD (side opening model). Both models are covered by standard ten-year warranty and designed to meet all applicable requirements of the ADA. There is no installation; the lift plugs into standard wall outlet and is ready for use. No building alterations or preparations are required. Additionally, the Ascension lift is the ideal solution for providing access to temporary stages and platforms.

**The Ascension portable wheelchair lift is the safest, qu
most durable, and easiest-to-use lift on the marke**



A DIVISION OF AGM

**3526 E Ft Lowell Rd
PO Box 40020
Tucson, AZ 85717-0020**

TEL: 1-800-459-0400 / 520-881-3993

FAX: 520-881-4983

**For additional information and a free demonstration video co
Brent Williams, Account Representative**

E-mail: sales@wheelchairlift.com

Site best when viewed with;



This site has been accessed

times since May 30, 1996

Copyright Ascension 1996-2002

ASCENSION MODEL SLA-2050ED

PORTABLE LIFT SPECIFICATIONS

Patent No. 6,182,798

PART 1 - GENERAL

1.1 Description of Product

The product described herein, manufactured by ASCENSION, Tucson, AZ, is a portable, lifting device intended for the exclusive use of individuals with disabilities. The lifting device shall be used only by individuals who are unable to negotiate stairs. The device shall be self contained, requiring no additional components or modifications of the using facility. The device shall consist of a car supported on an electro-hydraulic lifting mechanism that is attached to a wheeled undercarriage. The unit shall provide for independent use by individuals with disabilities and include a folding access ramp and all applicable operating and safety devices for compliance with ADA requirements. The wheeled undercarriage shall permit easy movement of the unoccupied device over hard, level surfaces. With the wheels retracted, the device shall rest firmly on any hard, level surface, and provide a stable base for operation of the lift. The unit shall provide adequate lifting force to raise the car and occupant to a height suitable for access to most stages, platforms, or similar elevated surfaces.

PART 2 - PRODUCT

2.1 Manufacturer

The unit shall be the Ascension Model SLA-2050ED Portable Wheelchair Lift, manufactured by ASCENSION, 3526 E Ft Lowell Rd, Tucson, AZ, 85716, TEL: 800-459-0400, FAX: 520-881-4983, E-MAIL: sales@wheelchairlift.com.

2.2 Physical Characteristics

- A. Occupancy capacity: one (1) person.
- B. Lifting capacity: 750 pounds [341 kg].
- C. Unit weight: 1200 pounds maximum [544 kg].
- D. Vertical speed: seven (7) fpm (feet per minute) [2.1 m/min (meters per minute)].
- E. Vertical travel: 6" to 50" [178 mm to 1270 mm], infinitely adjustable.

2.3 Dimensions

- A. Platform area: 39" x 54" [991 mm x 1372 mm] with 42" [1067 mm] high gates and side panels.
- B. Space requirements, operational: 49" [1245 mm] high, 50" [1270 mm] wide, 132" [3353 mm] long.
- C. Space requirements, storage and transport: 49" [1245 mm] high, 66" [1676 mm] long (ramp folded), 47" [1194 mm] wide.
- D. Ramp when lowered: 44" [1118 mm] wide, 72" [1829 mm] long, with a 1:12 slope.

2.4 Materials

- A. The car, base frame, and lifting device shall be constructed from ASTM A36, AISI 1018, or AISI 1020 Steel.
- B. The ramp shall be constructed of aluminum alloy.
- C. The windows shall be fabricated from 1/4" [6.35 mm] thick high impact strength clear thermoplastic.

2.5 Finish

All metal components shall be thoroughly cleaned to remove any foreign substance. Exposed metal surfaces shall be finished with an oven baked powder coating.

2.6 Electrical Requirements

Electric power requirements shall be compatible with 120VAC, 60 hertz, single phase, 10 amp service. The unit shall be supplied with a three prong grounded electrical cord. The unit shall contain a Ground Fault Circuit Interrupter (GFCI). The hydraulic pump shall be directly coupled to a capacitor start 1/2 hp motor. Other than the motor, all control and operating circuits shall be serviced by a 12 VDC solid state linear power supply. Electrical system components shall be UL listed and CSA registered.

ASCENSION MODEL SLA-2050ED

PORTABLE LIFT SPECIFICATIONS

Patent No. 6,182,798

2.7 Safety Devices

The unit shall be constructed to meet the applicable requirements of ADAAG, ASME A17.1 1996 or older (PART XX, SECTION 2000), ASME A18.1 1999, and ANSI A117.1 as they would apply to a portable lifting device. The assembly shall include the following safety features for protection of the passenger and general public.

- A. Grounded electrical system.
- B. 12 VDC operating controls.
- C. Key lock control switch.
- D. Constant pressure operating switches.
- E. Emergency stop buttons at all control locations.
- F. Latching gates.
- G. Electro-mechanical interlocks to prevent accidental gate opening.
- H. Gate switches to prevent car movement if either gate is open.
- I. Upper limit switch.
- J. Stage sensor box to stop ascent and release stage gate interlock at stage elevation.
- K. Toe-guard to automatically stop car descent if contact occurs.
- L. 42" [1067 mm] high walls and gates.
- M. Unobstructed view through transparent sides and gates.
- N. Grab bar extending full length of inside wall.
- O. Slip resistant surfaces on car floor, ramp, and dock plate.
- P. Indicator light to show when car is level with stage.
- Q. 7:1 structural safety factor.
- R. Floor switch to prevent operation if lift is not completely off its wheels.
- S. Self-closing gates.

2.8 Portability

Retractable wheels shall be permanently attached to the undercarriage. The wheels shall be capable of being raised or lowered with common hand tools. When the wheels are lowered and the access ramp folded for storage, the unit shall roll easily over any hard, smooth, level surface. The unit shall be capable of being moved by forklift or truck.

2.9 Operating Characteristics

- A. The unit shall include a single three (3) position key switch. One key position shall be marked "PASSENGER", one marked "ATTENDANT", and one marked "OFF". The key shall be removable only in the "OFF" position. The key position marked "PASSENGER" shall activate constant pressure "UP/DOWN" switches, located outside of the car at both ends and inside the car for the passenger's convenience. The key position marked "ATTENDANT" shall deactivate the passenger "UP/DOWN" switch located inside the car.
- B. All three (3) switch positions shall be provided with a separate "PUSH TO STOP" emergency button. The emergency stop button shall lock when pushed and require manual reset before operation can resume.
- C. A stage sensor box shall be provided which automatically stops the car when it reaches stage level. Additionally, the stage sensor box shall automatically activate an electro-mechanical interlock preventing the stage gate from being opened when the car is not at stage level. An indicator light shall be provided inside the car to show when the car has stopped at the correct level.
- D. Opening the stage gate shall deploy a dock plate that will rest on the adjacent stage surface. The dock plate shall provide a smooth transition between the car and the stage. Closing the stage gate shall retract the dock plate.
- E. The ramp gate shall be provided with a mechanical interlock that prevents the gate from being opened whenever the car is more than 1 inch [25.4 mm] above the full down position.

2.10 Disassembly/Reassembly

The unit shall be capable of being disassembled and reassembled on site to facilitate relocation through a 36" wide doorway. (Requires the use of an additional apparatus; available from Ascension.)

ASCENSION MODEL SLA-2050ED

PORTABLE LIFT SPECIFICATIONS

Patent No. 6,182,798

PART 3 - EXECUTION

3.1 Installation

Set up unit for operation as described in manufacturer's operating manual.

3.2 Maintenance

Maintenance of the unit shall consist of regular cleaning as deemed necessary by the using activity. General inspection, maintenance, and lubrication shall be specified in the manufacturer's service manual.

3.3 Warranty

A ten (10) year drive train, two (2) year parts, one (1) year labor limited warranty shall be provided.

NOTE: This specification has been written to assist in preparing a detailed description of a portable lift. All or part of this specification may be reproduced. Additional technical information may be obtained from ASCENSION, Tucson, AZ. Specifications are also available electronically in PDF at www.wheelchairlift.com. Specifications are subject to change.

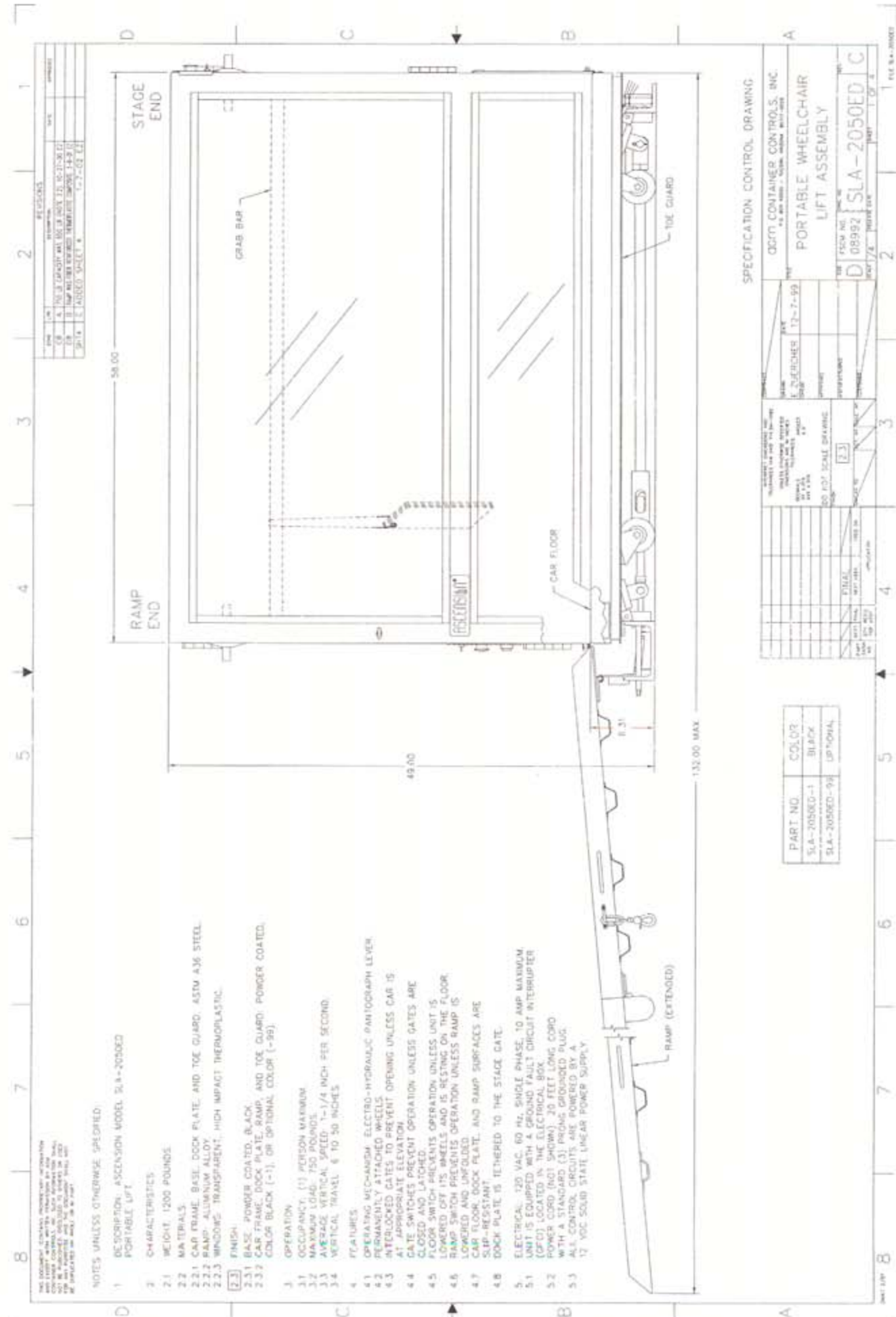

REV	DATE	DESCRIPTION
1	01-15-99	ISSUED FOR CONSTRUCTION
2	02-15-99	REVISED TO ADD TOE GUARD
3	03-15-99	REVISED TO ADD REFLECTOR
4	04-15-99	REVISED TO ADD GRAB BAR
5	05-15-99	REVISED TO ADD RAMP GUARD
6	06-15-99	REVISED TO ADD TOE GUARD
7	07-15-99	REVISED TO ADD REFLECTOR
8	08-15-99	REVISED TO ADD GRAB BAR

NOTES UNLESS OTHERWISE SPECIFIED:

- 1 DESCRIPTION: ASCENSION MODEL SLA-2050SD PORTABLE LIFT.
- 2 CHARACTERISTICS:
 - 2.1 WEIGHT: 1200 POUNDS.
 - 2.2 MATERIALS:
 - 2.2.1 CAR FRAME, BASE, DOCK PLATE, AND TOE GUARD: ASTM A36 STEEL.
 - 2.2.2 RAMP: ALUMINUM ALLOY.
 - 2.2.3 WINDOWS: TRANSPARENT, HIGH IMPACT THERMOPLASTIC.
 - 2.3 FINISH:
 - 2.3.1 BASE: POWDER COATED, BLACK.
 - 2.3.2 CAR FRAME, DOCK PLATE, RAMP, AND TOE GUARD: POWDER COATED, COLOR BLACK (-1), OR OPTIONAL COLOR (-99).
- 3 OPERATION:
 - 3.1 OCCUPANCY: (1) PERSON MAXIMUM.
 - 3.2 MAXIMUM LOAD: 750 POUNDS.
 - 3.3 AVERAGE VERTICAL SPEED: 1-1/4 INCH PER SECOND.
 - 3.4 VERTICAL TRAVEL: 6 TO 30 INCHES.
- 4 FEATURES:
 - 4.1 OPERATING MECHANISM: ELECTRO-HYDRAULIC PANTOGRAPH LEVER.
 - 4.2 PERMANENTLY ATTACHED WHEELS.
 - 4.3 INTERLOCKED GATES TO PREVENT OPENING UNLESS CAR IS AT APPROPRIATE ELEVATION.
 - 4.4 GATE SWITCHES PREVENT OPERATION UNLESS GATES ARE CLOSED AND LATCHED.
 - 4.5 FLOOR SWITCH PREVENTS OPERATION UNLESS UNIT IS LOWERED OFF ITS WHEELS AND IS RESTING ON THE FLOOR.
 - 4.6 RAMP SWITCH PREVENTS OPERATION UNLESS RAMP IS LOWERED AND UNFOLDED.
 - 4.7 CAR FLOOR, DOCK PLATE, AND RAMP SURFACES ARE SLIP-RESISTANT.
 - 4.8 DOCK PLATE IS TETHERED TO THE STAGE DATE.

- 5 ELECTRICAL: 120 VAC, 60 HZ, SINGLE PHASE, 10 AMP MAXIMUM.
- 5.1 UNIT IS EQUIPPED WITH A GROUND FAULT CIRCUIT INTERRUPTER (GFI) LOCATED IN THE ELECTRICAL BOX.
- 5.2 POWER CORD (NOT SHOWN): 20 FEET LONG CORD WITH A STANDARD (3) PRONG GROUNDED PLUG.
- 5.3 ALL CONTROL CIRCUITS ARE POWERED BY A 1/2 VDC SOLID STATE LINEAR POWER SUPPLY.

SPECIFICATION CONTROL DRAWING.

DORM CONTAINER CONTROLS, INC. 410 5TH AVE. S.W. TOLSON, ALABAMA 36503	
DATE: 12-7-99	BY: E. BURCHNER
PROJECT: PORTABLE WHEELCHAIR LIFT ASSEMBLY	SCALE: 3/4" = 1'-0"
PROJECT NO: D 08992	REV: 0
PART NO: SLA-2050ED	REV: 0

PART NO	COLOR
SLA-2050ED-1	BLACK
SLA-2050ED-99	OPTIONAL

(7) **CONCORD**

A cantilevered platform lift is manufactured by Concord in fixed position or portable unit model. The platform movement is controlled by a hydraulic cable drive. Operational controls are housed in the panel, fixed to the platform, and adjacent to the drive mechanism tower; therefore, this panel must be retained in any design scheme.

The fixed position unit was used to provide access to the judge's bench at the Williamsport, Pennsylvania U.S. Courthouse, visited as part of this Analysis.

P.A.L.® Standard Features

The following features are standard on all P.A.L. models making Concord lifts different from all others.

- 1:2 Cable Hydraulic Drive System provides smooth, quiet, dependable operation and leveling
- Emergency Battery Powered Lowering and Raising with Automatic Battery Recharging and Monitoring System for safe, dependable and uninterrupted use in the event of main building power failure
- Automatic Emergency Platform lighting in the event of main building power failure for added safety
- Choice of two large clear platform sizes of 35" W (890 mm) x 48" L (1220 mm) or 35" L (890 mm) x 54" L (1372 mm)
- Full 750lbs. of rated capacity providing a greater range of loading
- 42 1/4" (1073 mm) Aluminum Cab Frame for durability
- Elevator Guide Rail System for a stable and comfortable ride
- Cab Handrail for added safety and convenience
- Skid Resistant Flooring for increased safety
- Each component is individually painted with an electrostatic powder coated baked enamel finish for long lasting durability
- Fixed Ramp for non-pitted applications, or a flip-up ramp in non-enclosed, non-pitted applications
- Under Platform Obstruction Safety Sensor Plate stops the lift should the lift encounter an obstruction in the down direction in non-enclosed applications

Options

- Variety of platform configurations available including 90 degree exit and entry/exit same side
- 60" (1525 mm) platform lengths to accommodate larger mobility devices
- Exterior packages include weather resistant switches, control buttons, aluminum underpan, weather stripping and a heater blanket for colder climates
- Call/Send Controls at landings provide convenient access and attendant control from a single station
- Time Delay Door Locking for enhanced security
- Optional colors in electrostatic, powder coated, baked enamel finish to coordinate with any surroundings
- Automatic gate and door openers for additional convenience
- Flip up seat for versatility
- Optional gates, doors, and canvas covers are available to suit most applications



Optional two hour, UL/ULC Fire rated Doors for enclosed hoistway applications



Optional custom finishes in stainless steel, glass or bronze are available



Optional portable units are available on standard P.A.L. 4, and 6 foot units only

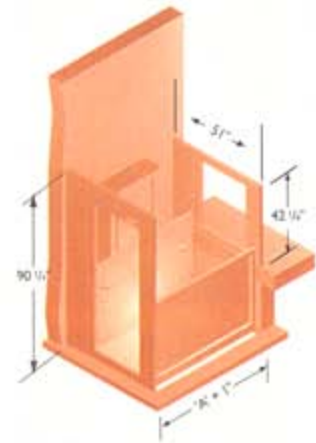

PAL-S - 48
2 stop, 36" of travel in a hoistway, in a pit, with full bottom door and top gate

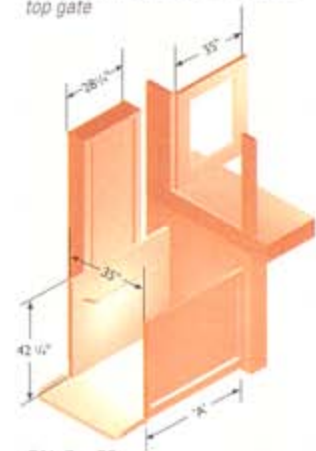

PAL-S - 72
2 Stop, thru cab with flip up ramp and top gate with no pit

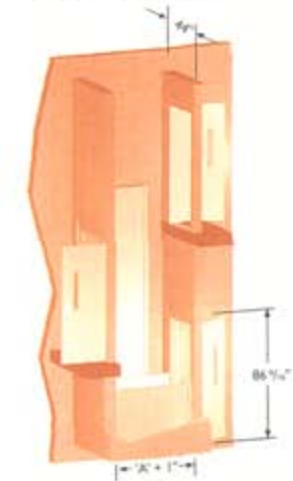

PAL-S - 168
In a hoistway with 3 fire rated doors, with a thru cab in a pit

A=platform length

P.A.L.®

Vertical Wheelchair Platform Lift

Warranty:

The Concord Limited Warranty covers replacement of any defective parts for a period of one (1) year.

For Suggested Specifications, and more information about the Concord P.A.L. Vertical Wheelchair Platform Lift and other Concord Products, visit our website at:

www.concordelevator.com or order your free CD ROM of Concord products by contacting us at:

Concord Elevator Inc.

107 Alfred Kuelme Blvd.
Brampton, Ontario
Canada L6T 4K3
Tel: (905) 791-5555
Fax: (905) 791-2222
1-800-661-5112

P.A.L.® Standard/Optional Feature Chart

	DESCRIPTION	MODEL		
		S	EN	SE
Standard Features	Drive - 1:2 Cable Hydraulic	S	S	S
	Capacity - 750 lbs. (341kg)	S	S	S
	Emergency Manual Lowering Device	S	S	S
	Cab Handrail	S	S	S
	Travel Speed - 14 feet per minute (0.07 m/s)	S	S	S
	Low Voltage (24 Volt DC)	S	S	S
	Emergency Power Lowering and Raising and Automatic Battery Recharging System	S	S	S
Controls	Emergency Platform Light	S	S	S
	Emergency Stop Switch	S	S	S
	Emergency Alarm Button	O	S	S
	Key Operation	S	S	S
	Intermediate Stop	O	O	-
	Platform Control Directional Switches	S	S	S
	Landing Call Stations	O	O	O
Platforms	Standard Platform 35" (890 mm) Width x 48" (1220mm) or 54" (1372 mm) Length	S	S	S
	60" (1524 mm) Platform Length	O	O	O
	Enter/Exit Same Side	O	O	-
	90 degree exit	O	O	-
	Flip-Up Ramp	S	-	-
	Stationary or Fixed Permanent ramps (if applicable)	S	S	S
	Under Platform Safety Fan in Non-Hoistway Applications	S	S	S
Doors & Gates	Pit Switch for Hoistway Applications	S	S	S
	Platform Gate	O	-	S
	Lower Landing Gate/Door	O	S	S
	Upper Landing Gate	O	O	S
	Upper Landing Door	O	O	O
	6" - 8" (2032 mm) Flush Mounted, 2 hour Fire-Rated Door & Frame	O	O	O
	Time Delay Door Locking	O	O	O
Miscellaneous	Removable Base	S	S	S
	Portable Unit	O	-	-
	Exterior Package	O	O	O
	Dome or Slope Roof	-	O	-
	Interlocks	O	S	S
	Flip-Up Seat	O	O	O
	Baked Electrostatic Powder Coat Paint, Architectural White Colour (standard)	S	S	S
Optional and Custom Paint Colours	O	O	O	

Legend: S = Standard, O = Optional, - = Not Available

Technical Aspects

Power:	110 Volt, single phase, 60 hertz 220 Volt, single phase, 50 hertz
Drive:	1:2 Cable Hydraulic
Speed:	14 ft/min, (0.08 m/s) nominal
Rated Load:	750 lbs. (341 Kg)
Platform Dimensions:	35"W (890 mm) x 48"L (1220 mm) or 35"W (890 mm) x 54"L (1372 mm)
Emergency Backup:	Automatic Emergency Battery Powered Lowering & Raising with Automatic Battery Recharging
Control Type:	Constant Pressure
Electronics:	Solid State 24 Volt DC Circuitry
Maximum Travel:	14 Feet (4.25 m)
Finish:	Electrostatic powder coated baked enamel

Authorized Dealer



Handilift® Standard Features

The following features make the Handilift one of the most dependable, easy to install, and cost effective vertical wheelchair lifts available today.

- Self-Lubricating Acme Screw Drive system for maintenance free operation
- Rigid extruded aluminium cab with steel inserts for strength and durability.
- Automatic flip-up ramp or permanent ramp for increased safety
- Cab handrail for added safety and convenience
- Skid resistant flooring
- All parts individually painted with an electrostatic, powder coated baked-on enamel finish for long lasting durability and appearance



Handilift with top gate with steel inserts



Optional portable units are available on 3, 4, and 6 foot units

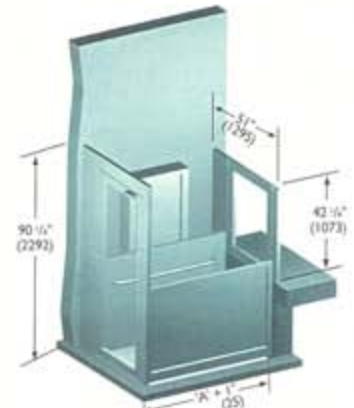

Handilift - 36
2 stop, 36" of travel in a hoistway, in a pit, with full bottom door and top gate



Handilift - 72
2 Stop, thru cab with flip up ramp and top gate with no pit

A=platform length

Options

- Exterior package with water-resistant switches and buttons, weather stripping, and aluminium underpan
- Call/Send controls at landings allow attendant control and also enables the lift to be 'called' or 'sent' to another landing
- Under Platform Obstruction Sensors for added safety
- A variety of doors, fire doors and gates are available to suit any application
- Domed or sloped roofs available on the EN model
- Optional colors in electrostatic, powder coated baked-on enamel finish for long lasting durability and appearance



Optional two hour UL/ULC Fire-Rated doors for enclosed hoistway applications

(8) VERTICAL MOBILITY
(WITNESS STAND ACCESSOR)

This manufacturer provides a cantilevered platform lift with an Acme screw drive mechanism. Occupant controls and a handrail are integrated into the enclosure panel adjacent to the drive mechanism tower. (The panel can be clad with various materials as shown in the photographs on the following pages.)

A combination two-step riser and gate assembly that swings away from the lift enclosure as one element is an accessory that can be incorporated into the installation.

Witness Stand Accessor



Normal position



Barrier arm up — ready for platform to lower for access



Platform lowered for wheelchair access — gate/step hinged open



Platform at judge's bench level



VERTICAL Mobility, L.L.C.
Innovative Products for Independent Access

3949J Dayton Park Drive • Dayton OH 45414
937-236-2888, voice • 937-236-3680, fax
www.verticalmobility.com • info@verticalmobility.com

Vertical Mobility Witness Stand Accessor Specifications

Part 1 – General

1.1 Product

The product described is a courtroom witness stand combined with the function of a platform lift for use by persons with disabilities. The product consists of a motor driven platform lifting mechanism, which moves the floor of the witness stand up and down.

1.2 Quality Assurance

The product complies with applicable sections of ADAAG and NFPA 70. The product is manufactured by an ISO 9001 registered facility. A one year limited warranty is provided. Vertical Mobility's Optional Six-Year Warranty requires inspections every six months and covers most maintenance requirements.

Part 2 – Product

2.1 Manufacturer

Vertical Mobility LLC
3949-J Dayton Park Drive
Dayton, Ohio 45414

2.2 Lift Equipment

- A. **Model:** Vertical Mobility VMW Witness Stand
- B. **Capacity:** 750 pounds with a 5x-safety factor
- C. **Nominal Speed:** 10 feet per minute max.
- D. **Platform:** Platform is lifted by an acme screw mechanism. Platform is the floor of the witness stand. Platform is constructed from aluminum plate. The platform is covered with commercial flooring surfaces selected by customer. Platforms are sized for the application.
- E. **Suspension Means:** Steel acme screw column assembly
- F. **Structure:** Framework is constructed of structural steel welded to the appropriate dimensions. Steel surfaces are covered with a corrosion resistant coating.
- G. **Lift Mechanism:** Maximum travel is 24 inches. The lifting forces are carried by (4) 1" diameter steel acme screws. The 4 screw columns are connected to the platform at the corners. Mechanical travel limiting stops are included at the top and bottom.
- H. **Drive System:** The lift mechanism is operated by (1) 2 horsepower, 208/230 VAC electric motor. The acme screw columns can not be back-driven and hold the platform in position when the motor stops. Manual lowering is included. The electrical cabinet is located in the sidewall and is accessible through a removable panel. The entire operating mechanism is completely guarded by being enclosed in the witness stand sidewalls.
- I. **Finish:** The visible surfaces are covered with decorative panels of the customer's choice. Label plates stating the lift capacity rating, product identification number, and the machine data are prominently displayed.
- J. **Power Requirements:** 208/230 VAC 60 Hz 30 amp single-phase power source is required. Disconnect switch is provided for the 208/230 VAC.

2.3 Safety Features

- A. **Lift Operating Controls:** Controls include a security key switch, constant pressure push buttons for raising and lowering, and an emergency stop. Up and down controls will not operate at the same time. Audible alarms are available if permitted in the courtroom.
- B. **Safety:** Lift movement stops in either direction if safety gate opens or if obstruction is encountered. Lift can be "backed away" from an obstruction without the requirement to first clear the obstruction.
- C. **Platform Side Guard:** The sidewalls and safety gate provide full perimeter side guarding; the height of these side guards will be determined by the courtroom layout.

Part 3 – Execution

3.1 References

- A. Unit Installation Manual
- B. NFPA 70
- C. All local codes having legal jurisdiction

3.2 Installation

- A. No pit is required. The Witness Stand sets flat on building floor.
- B. Authorized and Trained Vertical Mobility Dealer to deliver and set-up unit per Installation Manual and applicable codes.
- C. Electrical connection is to power supplied to nearby "J" box by others.

3.3 Maintenance

Witness Stand is to be maintained per manufacturer's instructions. Vertical Mobility's Optional Six-Year Warranty covers most maintenance requirements.

(9) **GIANT LIFT**
(LIFE LIFT)

The *Life Lift* model is a cantilevered platform lift without the requirement of a equipment pit, but it does need a small approach ramp at the lowest level.

The design depends on a hydraulic chain drive operating mechanism mounted in the equipment tower and controls are attached to platform enclosure panels.

None of the units manufactured by Giant Lift were installed at the courtrooms visited during this Analysis.

[Home](#)[Products](#)[News](#)[Contact Us](#)

GiantLift Equipment Mfg Co Inc

E-Mail: GiantLift@aol.com

*PO Box 626 * North Hampton NH 03862 * 800-52-GIANT*

NEED A LIFT? CALL THE GIANT!



Let Giant Lift show you the dependability and reliability of a manufacturer who's been designing and manufacturing for 27 years.

From it's inception in 1972, Giant Lift has been committed to manufacturing the highest quality products possible. Giant Lift has both the facilities and the know-how to handle virtually any type of design/manufacturing assignment.

Our biggest assets are the pride our staff takes in their work, and a nationwide network consisting of over 700 Material Handling Distributors. This combination is clearly reflected in the quality of our products and service.

High technology, computer-aided design techniques, and 27 years of expertise, has enabled us to develop equipment and systems that fit a customer's operation and facilities.

Giant Lift Equipment Mfg Co Inc

E-Mail: GiantLift@aol.com

PO Box 626 * North Hampton NH 03862 * 800-52-GIANT

Constructed of highest quality materials and engineered for safety

A full three (3) foot by four (4) foot non-skid platform provides a sufficient space for the wheelchair as well as a person to assist.

For construction convenience and economy, the Life Lift has been designed with an above the ground frame, eliminating the need for a pit. The retractable ramp allows easy access to the platform, with a very slight incline that is easy to maneuver. An integral part of the ramp is hinged plate which automatically prevent the wheelchair from rolling off the raised platform.

The emergency hand lowering valve allows the platform to be lowered, even if the electrical power has failed. This prevents the passenger from being trapped upstairs.

Standard construction features such as a TEFC motor allow the machine to be indoors or outdoors with few additional requirements. Durable enamel paint gives a wear-resistant professional finish.

For safety reasons solid panels are 72 inches high on the lift mechanism side of the platform and 42 inches on all other non-access sides.

The heavy duty hydraulic drive unit includes an industrial duty non-reversing squirrel induction type motor - 3/4 HP for both 500 pound capacity and 750 pound capacity. The motor does not run in the down motion, saving electric power and reducing wear. The down operation is activated by the open solenoid valve. Precision roller bearing cam followers provide a smooth, even platform rise. The system is fail safe; the platform will remain up in the event of an electrical failure. The hydraulic cylinder is connected to the platform by two chains; allowing two pick up points. Each chain has a safety factor of 7 to 1 - exceeding code requirements. The use of chain eliminates the problem of cable stretch.

Safety Features

Falling platform safety devices (Class B elevator safety dogs) are found only on the Life Lift. Should the chains slacken or loosen, the spring loaded safeties will release automatically and hold the platform in the raised position until manually released.

All controls are 24 volt, as per code. Constant pressure key operated stations are standard. The Life Lift is fully tested and pre-wired at factory, ready to plug into any standard 110 volt outlet or be hard wired.

Optional equipment and design features.

42 inch landing gates electro-mechanically interlock to prevent operation of the lift if the gate is open. The gate cannot be opened unless the platform is at the gate level. Gates open from either side.

Under platform obstruction sensors stop platform if there is an obstruction underneath.

Control options include push-button stations and digital control access. All can be cord mounted for easy handling.

SECTION SEVEN

ANALYSIS PROCESS AND ACTIVITIES

OVERALL PROCESS

The Analysis process consisted of the following activities:

- (1) Preparing a detailed survey containing questions relative to design, installation, and performance of the lifts that was distributed to 51 individuals involved in the process of incorporating mechanical lifts into the courtroom environment;

(Thirty eight written responses were received; and telephone interviews provided supplemental clarification where necessary.)

- (2) Investigating current formal documented criteria for design and performance of mechanical lifts from Government and industry standards;
- (3) Observing mechanical lift installations;

(Extensive photography was taken of the lift, related details of the operation mechanism, and enclosure elements. Video recording of the lift in operation was conducted as well as interviews with Courts representatives and GSA personnel familiar with the selection, installation, and operation of the lifts at each site.)

- (4) Recording information related to the different manufacturers and types of lifts identified at the site visits, plus other systems recognized during the research process conducted by HDR and Lerch, Bates and Associates;
- (5) Summarizing and comparing the design, installation, and performance characteristics of the 16 installations investigated to determine common problems;
- (6) Researching all the most stringent requirements from applicable codes, laws, and industry standards to make sure recommendations in this analysis will comply; and
- (7) Formulating recommendations for future installations.

SURVEY PROCESS

(The following project description and survey form were sent to 51 representatives of the GSA and the U.S. Courts to obtain information regarding design, installation, operation, and maintenance at vertical mechanical lift installations in 16 U.S. Courthouse locations. There were 38 written responses and additional information was obtained by telephone conversations and interviews during the site visits.)

U.S. GENERAL SERVICES ADMINISTRATION COURTHOUSE MANAGEMENT GROUP

MECHANICAL LIFT ANALYSIS

*(ACCESSIBILITY METHOD FOR ACCOMMODATION
OF PHYSICALLY DISABLED PEOPLE IN U.S. COURTHOUSE COURTROOMS)*

SURVEY REGARDING EXISTING MECHANICAL LIFT INSTALLATIONS

The U.S. Courts have been experiencing problems with the design, installation, and operation of mechanical lifts used to provide access for physically disabled people at the various functions within a courtroom including the witness box, jury box, judges' bench, and clerks' desk.

An analysis is being performed to determine the source of these problems and also identify reliable designs plus installations that could be used as examples for future projects. HDR Architecture, Inc., (HDR), an IDIQ Contractor to the GSA, is assisting the Courthouse Management Group (CMG) with the development of the Analysis.

The following U.S. Courthouses are participants in this effort:

Scranton, Pennsylvania
Knoxville, Tennessee
Covington, Kentucky
Omaha, Nebraska
Brownsville, Texas
Phoenix, Arizona
Lafayette, Louisiana
Corpus Christi, Texas
Wilkes-Barre, Pennsylvania
Williamsport, Pennsylvania
Las Vegas, Nevada
Denver, Colorado
Fargo, North Dakota
Kansas City, Missouri
Baton Rouge, Louisiana

Survey Process

The process will start with the distribution and completion of survey forms included with this narrative. Once the responses have been received, they will be preliminarily analyzed for any consistent problems. (It is also anticipated that conditions will be discovered where lifts function very effectively.)

Other Aspects Of The Study

During the time period that the surveys are being filled out and sent back to HDR, three other tasks will be addressed to include:

- Identification of all available lift manufacturers;
- Investigation of research being done on new lift systems; and
- Analysis of all current code and other regulatory requirements pertaining to mechanical lift design and installation.

Site Visits

During the last week in April and the first two weeks of May, representatives of HDR will be traveling to each participating courthouse to interview appropriate staff regarding the design, operation, and maintenance of the installed lifts. At the same time, the lift will be photographed in detail, and the operation recorded on videotape. (Site visit schedules will be developed while the surveys are being filled out and returned, during the second and third week of April.)

It is very important that all documentation related to the lifts design, installation, and operation, which may be located at the facility engineer's office or with the local GSA representative, be made available for review during the site visit.

Findings

Once site visits are completed, a detailed analysis of all the conditions discovered will be done related to issues of design, installation, and operation; the information received from manufacturers will be summarized; and a consolidation of current regulations shall also be prepared in a summary report.

Together, these various aspects of the study will identify the best options in specifying mechanical lift systems for future U.S. Courthouse projects.

Your participation in this very important analysis is highly valued.

**U.S. GENERAL SERVICES ADMINISTRATION
COURTHOUSE MANAGEMENT GROUP**

MECHANICAL LIFT ANALYSIS

*(ACCESSIBILITY METHOD FOR ACCOMMODATION
OF PHYSICALLY DISABLED PEOPLE IN U.S. COURTHOUSE COURTROOMS)*

File: lftsvy.a03

SURVEY REGARDING EXISTING MECHANICAL LIFT INSTALLATIONS

U.S. Courthouse Location:

Name & Title of Person
Completing the Survey:

A. Where are mechanical lifts used for accessibility in the courtrooms ?

- Witness Boxes
- Judges' Benches
- Jury Boxes
- Clerks' Desks
- Other

Explain:

B. What type of lift(s) have been installed in the courtrooms of this facility?

- Hydraulic
- Scissors
- Other

Explain:

C. How many mechanical lifts are located within a courtroom ? _____

D. Who is the manufacturer of the lifts ? _____

E. How long have the lifts been in operation in the courtrooms ? _____

F. Do the lifts provide accessibility to 1 or 2 levels ? _____
(Do the lifts stop at 1 or 2 levels ?)

G. How well has the lift apparatus been integrated into architectural design, particularly related to the millwork ? (Is it concealed within the architectural elements ?)

H. Do you consider the lift to be dependable and effective in operation ?

I. Are people apprehensive in using the lift ?
(Does the lift give a good sense of stability while in motion,
and at the suspended position[s] ?)

J. Have the lifts required service since installation ?

1 For what conditions ?

2 How soon after installation ?

3 Is service provided locally ?

K. If you are having problems with the lifts are they related to:

1 Design

2 Installation

3 Operation

4 General Maintenance

MECHANICAL LIFT ANALYSIS

STATUS OF CONTACTS; SURVEY DISTRIBUTION / RETURN; INTERVIEWS; & SITE VISIT COORDINATION

FILE: courts.a03 UPDATE: 5/3/02; 5/14/02, 5/22/02;6/17/02:

PROJECT: (CONSTR. COMPLETED)	REPRESENTATIVES:	NAME:	LOCATION:	TELEPHONE #:	EMAIL ADDRESS:	SURVEY SUBMISSION				TRIP SCHEDULE	
						DATE SENT:		DATE RETURNED:		DATE:	HDR TRIP:
SCRANTON, PENNSYLVANIA (MARCH, 1999) WILLIAM J. NEALSON U.S. COURTHOUSE	GSA PROJECT MANAGER	ED MYERS	PHILADELPHIA, PA	(215) 656-5762	ed.myers@gsa.gov	5/6/2002	email	5/9/2002	email		PITARQUE
	U.S COURTS REP.	MATT HEMPHILL	SCRANTON, PA	(570) 207-5661	matt_hemphill@pamd.uscourts.gov	4/22/2002	email	Interview at site		5/17/2002	
	GSA BLDG. / REGION MGR.	RAY FOOTE	SCRANTON, PA	(570) 346-7814	ray.foote@gsa.gov	5/3/2002	email	Interview at site		5/17/2002	
	A/E & REP.	BOHLIN / CYWINSKI / JACKSON	SCRANTON, PA	(570) 825-8756	rroberts@bcj.com	5/3/2002	email	5/3/2002	email		
		PM: RUSS ROBERTS									
	SUPPLIER	CUSTOM UNIT									
	INSTALLER	MISCARO CONSTRUCTION									
		PM: MIKE KANE		(412) 321-4901							
KNOXVILLE, TENNESSEE (SEPTEMBER, 1998)	GSA PROJECT MANAGER	LAURA SHADIX	ATLANTA, GA	(404) 331-7965	lauria.shadix@gsa.gov	5/3/2002	email	5/16/2002	email	6/14/2002	GENRICH
	GSA BLDG. / MAINT. MGR.	DENNIS GENTRY	KNOXVILLE, TN		dennisa.gentry@gsa.gov	4/26/2002	email	6/5/2002	fax		
		SCOTT HAWKINS		(865) 971-4041							
				(865) 631-2225 (P.)							
HOWARD BAKER JR. U.S. COURTHOUSE	U.S. COURTS REP.										
	A/E & REP.	HLM	ORLANDO, FL	(407) 422-7061	begleston@hlmdesign.com	5/3/2002	email				
		PM: BOB EGLESTON									
	SUPPLIER	T.L. SHIELD									
TALLAHASSEE, FLORIDA	GSA PROJECT MANAGER	STEVEN SOMMER	ATLANTA, GA	(404) 331-3271	steven.sommer@gsa.gov	4/30/2002	email				NO SITE VISIT
	U.S. COURTS REP.	MARILYN HOLLAND	TALLAHASSEE, FL	(850) 521-3532	marilyn_holland@flnd.uscourts.gov	4/30/2002	email				
	GSA BLDG. / MAINT. MGR.	DANA WHITE	TALLAHASSEE, FL	(850) 942-8871	dana_white@flnd.uscourts.gov	5/2/2002	email				
				(850) 508-7392 (C.)							
	A/E & REP.	REYNOLDS, SMITH, & HILLS	JACKSONVILLE, FL	(904) 296-2000	john.botaro@rsandh.com	5/6/2002	email	5/10/2002	email		
	PM: JOHN BOTARRO										
	GSA ADA REGIONAL REP.	ALISA SCALLEY	ATLANTA, GA	(404) 331-6386	alisa.scallev@gsa.gov	5/2/2002	email				
	SUPPLIER	ASCENSION (PORTABLE UNIT)									
BATON ROUGE, LOUISIANA (LIFT INSTALLATION IN PLACE 1 1/2 YEARS)	GSA PROJECT MANAGER										GENRICH
	COURTROOM DEPUTY	CHRISTI CAUSEY	BATON ROUGE, LA	(225) 389-3582							
	GSA BLDG. MGR.	PAUL HEITMAN	BATON ROUGE, LA	(225) 907-6599	paul.heitman@gsa.gov	5/2/2002	email	5/2/2002	email		
	GSA MAINTENANCE MGR.	JIM JOHNSON	BATON ROUGE, LA					Interview at site		5/7/2002	
	A/E & REP.										
RUSSELL B. LONG U.S. COURTHOUSE	SUPPLIER	T.L. SHIELD									

PROJECT: (CONSTR. COMPLETED)	REPRESENTATIVES:	NAME:	LOCATION:	TELEPHONE #:	EMAIL ADDRESS:	SURVEY SUBMISSION				TRAVEL SCHEDULE	
						DATE SENT:		DATE RECEIVED:		DATE:	HDR TRIP:
COVINGTON, KENTUCKY (JUNE, 2000)	GSA PROJECT MANAGER	MIKE FIFTY	ATLANTA, GA.	(404) 331-7576	michaelp.fifty@gsa.gov	4/22/2002	email	4/30/2002	email	6/6/2002	GENRICH
				(404) 433-8443 (C.)							
	U.S. COURTS REP.	STEVE HOFFNER	LEXINGTON, KY	(859) 233-2503		5/3/2002	FAX	5/8/2002	fax		
				(859) 233-2470 (F.)							
	GSA BLDG. / MAINT. MGR.	NEIL MORGAN / JEFF EDWARDS	LOUISVILLE, KY	(502) 582-6436	christophermorgan@gsa.gov						
				(502) 594-6709 (C.)							
	A/E & REP.	SHERMAN CARTER BARNHART		(859) 224-1351	rselin@scb.ky	4/30/2002	email				
		ROB SELIN									
	SUPPLIER										
OMAHA, NEBRASKA (JUNE,2000)	GSA PROJECT MANAGER	JOHN TOPI	KANSAS, MO.	(816) 823-4903	john.topi@gsa.gov	4/22/2002	email	5/2/2002	email		WERMAN
		GARY McFARLAND	OMAHA, NE		gary_mcfarland@ned.uscourts	6/7/2002	email				HDR-OMAHA
	U.S. COURTS REP.	STACY FELDER (INTERIOR DES.)	OMAHA, NE	(402) 661-7376	stacy_felder@ned.uscourts	6/7/2002	email				
	GSA BLDG. / MAINT. MGR.	MARY ANN KOSMICKI	OMAHA, NE	(402) 221-4725	maryann.kosmicki@gsa.gov	6/7/2002	email	6/11/2002	email	6/12/2002	
	ROMAN L. HRUSKA U.S. COURTHOUSE	A/E & REP.	DLR	OMAHA, NE	(402) 393-4100						
			PM: BOB CERNEVIC								
	SUPPLIER										
BROWNSVILLE, TEXAS	GSA PROJECT MANAGER	RICHARD STEPHENSON	FORT WORTH, TX	(817) 978-2402	richard.stephenson@gsa.gov	5/12/2002	email	5/13/2002	email		GENRICH
	GSA BLDG. MAINT. MGR.	BENITO BRUNO	BROWNSVILLE, TX	(956) 548-2525				Interview at site		5/9/2002	
	U.S. COURTS REP.	BUTCH BARBOSA	BROWNSVILLE, TX	(956) 548-2507	butch_barbosa@txs.uscourts.gov	4/25/2002	email	5/10/2002	email		
	GSA BLDG. MGR.	TONY CERRILLO	BROWNSVILLE, TX	(956) 548-2525	tony.cerrillo@gsa.gov	5/2/2002	email			5/9/2002	
	A/E & REP.	PGAL	HOUSTON.TX	(713) 622-1444							
			PM: MICHAEL LLOYD								
	SUPPLIER	T.L.SHIELD / SOUTHWORTH									
PHOENIX, ARIZONA (MAY,2001)	GSA PROJECT MANAGER	KEITH LEW	SAN FRANCISCO, CA	(415) 522-3147							GENRICH
	U.S. COURTS DIST. ARCH.	ROSS BERN	PHOENIX, AZ	(602) 322-7130	ross_bern@azd.uscourts.gov	4/25/2002	email	5/3/2002	email	5/24/2002	
				(602) 525-2406 (C.)							
	GSA BLDG. / MAINT. MGR.										
	A/E & REP.	LANGDON / WILSON	LOS ANGELES, CA								
	SANDRA DAY O'CONNOR U.S. COURTHOUSE	SUPPLIER	T.L. SHIELD								

PROJECT: (CONSTR. COMPLETED)	REPRESENTATIVE:	NAME:	LOCATION:	TELEPHONE#:	EMAIL ADDRESS:	SURVEY SUBMISSION				TRIP SCHEDULE:	
						DATE SENT:		DATE RETURNED:		DATE:	HDR TRIP:
LAFAYETTE, LOUISIANA JOHN M. SHAW U.S. COURTHOUSE	GSA PROJECT MANAGER	DALE SHERMAN	FORT WORTH, TX	(817) 978-7131	dale.sherman@gov	4/30/2002	email				GENRICH
	U.S. COURTS REP.	DRUE SMITH	SHREVEPORT, LA	(318) 676-4226	drue_smith@lawd.uscourts.gov	4/25/2002	email	4/29/2002	email		
	GSA BLDG. MGR.	PAUL HEITMAN	BATON ROUGE, LA	(225) 389-0304	paul.heitman@gsa.gov	5/2/2002	email	5/2/2002	email		
				(337) 233-0614							
				(225) 907-6599 (C.)							
	CONTRACT MAINTENANCE	LARRY CARRIER	LAFAYETTE, LA	(337) 233-3322					Interview at site		5/7/2002
	CONTRACT MAINTENANCE	GLEN RICHARD	LAFAYETTE, LA	(337) 233-3322					Interview at site		5/7/2002
	A/E & REP.	JOINT VENTURE OF 3 FIRMS PM: CHARLES BEAZLEY	LAFAYETTE, LA	(337) 233-0614	cb@qbarchitects.com	5/2/2002	email				
SUPPLIER	T. L. SHIELD										
CORPUS CHRISTI, TEXAS	GSA PROJECT MANAGER	DALE SHERMAN	FORT WORTH, TX	(817) 978-7131	dale.sherman@gsa.gov	4/30/2002	email				GENRICH
	DEPUTY CLERK	MONICA SEAMAN	CORPUS CHRISTI, TX	(361) 888-3142	monica_seaman@tx.uscourts.gov	4/30/2002	email		Interview at site		
	ASSIST. GSA BLDG. MGR.	DANA OLSON	CORPUS CHRISTI, TX	(361) 888-3330 (C.)	dana.olson@gsa.gov	5/3/2002	email		Interview at site		5/8/2002
				(361) 537-3330							
	MAINTENANCE										
	A/E & REP.	WKMC			wmccord@wkmccarchitects.com	5/3/2002	email	5/6/2002	email		
		WILLIAM McCORD	CORPUS CHRISTI, TX	(361) 887-6696							
SUPPLIER	T.L. SHIELD										
WILKES-BARRE, PENNSYLVANIA MAX ROSENN U.S. COURTHOUSE	GSA PROJECT MANAGER	ED MYERS	PHILADELPHIA, PA	(215) 656-5762	ed.myers@gsa.gov	5/6/2000	email	5/9/2002	email		PITARQUE
	U.S.COURTS REP.	MATT HEMPHILL	SCRANTON, PA	(570) 207-5661	matt_hemphill@pamd.uscourts.gov	4/22/2002	email		Interview at site		5/17/2002
	GSA BLDG. / REGION MGR.	RAY FOOTE	SCRANTON, PA	(570) 346-7814	ray.foote@gsa.gov	5/3/2002	email		Interview at site		5/17/2002
	A/E & REP.	KLING / LINQUIST PM: BOB MYER	PHILADELPHIA, PA	(215) 569-2900							
	SUPPLIER	T.L. SHIELD									
	INSTALLER	KETTING BUILDING CONSTR. CONTACT: TRACY GREER			(610) 668-4100						
WILLIAMSPORT, PENNSYLVANIA (LIFT INSTALLED 4/15/2002) HERMAN T. SCHNEEBELI U.S. COURTHOUSE	GSA PROJECT MANAGER	ABIGAIL SMITH	PHILADELPHIA, PA	(215) 656-5682	abby.smith@gsa.gov	5/6/2002	email	5/6/2002	email		PITARQUE
	U.S.COURTS REP.	MATT HEMPHILL	SCRANTON, PA	(570) 207-5661	matt_hemphill@pamd.uscourts.gov	4/22/2002	email		Interview at site		5/17/2002
	GSA BLDG. / MAINT. MGR.	DOUG LOGAR		(717) 221-4457	doug.logar@gsa.gov	5/13/2002	email		Interview at site		5/16/2002
	A/E & REP.	DRS ARCHITECTS PM: SARINA BODNAR	PITTSBURGH, PA	(412) 391-4850	sarina_bodnar@drsarchitects.com	5/2/2002	email				
	SUPPLIER	WITNESS LIFT - T.L. SHIELD; JUDGES BENCH - SARINA WILL VERIFY.									

PROJECT: (CONSTR. COMPLETED)	REPRESENTATIVES:	NAME:	LOCATION:	TELEPHONE#:	EMAIL ADDRESS:	SURVEY SUBMISSION				DATE; DATE RETURNED:	HDR TRIP:
						DATE SENT:					
LAS VEGAS, NEVADA (JANUARY, 2001)	GSA PROJECT MANAGER	MARIO RAMIREZ	SAN FRANCISCO, CA	(415) 522-3158	mario.ramirez@gsa.gov	4/22/2002	email	5/9/2002	email	5/23/2002	GENRICH
	U.S. COURTS REP.	LANCE WILSON	LAS VEGAS, NV								
	GSA BLDG. / MAINT. MGR.	STEVE UNDERHILL / RON CLARK	LAS VEGAS, NV	(702) 388-6289					Interview at site		
				(702) 219-7936 (C.)							
LLOYD D. GEORGE U.S. COURTHOUSE	A/E & REP.	JOHN LYNCH	LAS VEGAS, NV	(702) 303-4269							
		LANGDON / WILSON	LOS ANGELES, CA	(213) 250-1186							
	SUPPLIER	NATIONAL WHEEL-O-VATOR									
DENVER, COLORADO ALFRED A. ARRAJ U.S. COURTHOUSE	PROJECT MANAGER	CURTIS BERG		(303) 236-7070	curtis.berg@gsa.gov	5/17/2002	email			5/23/2002	POPP
				EXT. 242							LERCH /
	U.S. COURTS REP.										BATES
	GSA BLDG. / MAINT. MGR.										
	A/E & REP.										
KANSAS CITY, MISSOURI (JUNE, 1998)	GSA CONSTR. ENGR.	BOB EK	KANSAS CITY, MO	(816) 823-4914	bob.ek@gsa.gov	5/3/2002	email	5/14/2002	email	5/16/2002	POPP
	U.S. COURTS REP.	PAT BRUNE	KANSAS CITY, MO	(816) 512-5020	pat.brune@mow.uscourts.gov	5/15/2002	email	5/23/2002	fax		LERCH /
	GSA BLDG. / MAINT. MGR.	BILL KELB (REFERRED BY LISA CASON)		(913) 551-1433	bill.kelb@gsa.gov	5/17/2002	email				BATES
	A/E & REPRESENTATIVE	ELLERBE / BECKET	KANSAS CITY, MO	(816) 360-4675	earl_wilson@ellerbebecket.com	5/3/2002	email				
CHARLES E. WHITTAKER U.S. COURTHOUSE		PM: EARL WILSON									
	SUPPLIER	T.L. SHIELD									
TUCSON, ARIZONA											
FARGO, NORTH DAKOTA (JUNE, 1997)	GSA PROJECT MANAGER										PRATT
	DEPUTY IN CHARGE	TODD DUDGEON	FARGO, ND.	(701) 297-7000	todd_dudgeon@ndd.uscourts.gov	5/14/2002	email				HDR - FARGO
	GSA BUILDING MANAGER	BRYAN SAYLER	FARGO, ND.	(701) 239-5453	bryan.sayler@gsa.gov	5/2/2002	fax	5/17/2002	fax	5/17/2002	
	A/E & REPRESENTATIVE	MBA									
	QUENTIN N. BURDICK U.S. COURTHOUSE		PM: CRIS VAN HAL	FARGO, ND	(701) 235-5563	Chris@300np.com	5/6/2002	email	5/10/2002	email	
MARICOPA COUNTY COURTHOUSE PHOENIX, AZ	COMM. MEDIA RELATIONS	J.W. BROWN / HUGH GALLAGER		(602) 506-7378					Interview at site	5/24/2002	GENRICH
				(602) 506-3912							
	SUPPLIER	ACCESS INDUSTRIES - PORCH-LIFT									

**U.S. GENERAL SERVICES ADMINISTRATION
COURTHOUSE MANAGEMENT GROUP****SECTION 8****MECHANICAL LIFT ANALYSIS – SUPPLEMENT**
(MARCH 2005)**PART 1 – ASSESSMENT OF THE SPIRALIFT SYSTEM****PURPOSE OF THE SUPPLEMENT**

The *Spiralift* design concept was identified by GSA as a possible unique design solution and an alternative to the hydraulic/scissors and cantilevered platform concepts already described in the Mechanical Lift Analysis.

SPIRALIFT SYSTEM

**GALA THEATRICAL EQUIPMENT
PACO CORPORATION
ST. HUBERT, QUEBEC, CANADA**

DESCRIPTION OF THE SYSTEM AND ITS CURRENT USES

The *Spiralift* system was originally designed to provide an efficient means of raising and lowering elements within theatrical and/or music performance halls and auditoriums. These elements include the stage, orchestra platforms, and seating row levels. The custom designed lift systems consist of one or more standard *Spiralift* units connected by horizontal framing members to provide a smooth, level, and stable change in elevation. The *Spiralift* systems are currently manufactured in three sizes designated by diameter dimension including the 6 in., 9 in., and 18 in. models.

The manufacturer, Paco Corporation, has successfully tested the largest units for a 40 ft vertical travel distance sustaining a load of 40,000 lbs without any problems.

They have incorporated the 6 in. *Spiralift* elements into many custom design conditions, including placement on a frame with wheels to provide a portable unit.

The 6 in. unit with a capacity of 3,500 lbs is the one most feasible for adaptation to the courtroom witness box and Judge's bench accessibility requirements.

CHARACTERISTICS OF THE BASIC DESIGN

The design concept of the *Spiralift* consists of mechanical engagement between a heavy gauge coiled steel strap which is slipped within grooves of a flat spring forming a ribbed spiral column. The electrical worm-drive motor extends the spring vertically to allow insertion of the strap into a groove on the surface of the spring. This design is referred to as a tubular thrust screw. (See photographs and diagrams at the end of this section.)

These design characteristics minimize the compressed depth of the system by limiting the height to the compressed spring and the recoiled steel strap in the collapsed configuration. (The height of the *Spiralift* unit at a resting position is 9 $\frac{3}{4}$ in. and the thickness of the platform will be approximately 2 in., which makes the depth required at a recessed pit section containing the drive mechanism approximately 11 $\frac{3}{4}$ in. if the top of the platform is to be flush with the courtroom well finished floor level.)

Limit switches govern the suspended height and the brake can be released allowing manual lowering of the platform should there be a loss of electrical power. Control of the up and down movement is by push buttons.

The smaller single unit *Spiralift* platform design operates in combination with heavy gauge tubular steel scissors guide elements which help to provide stability.

ADAPTATION FOR ACCESSIBLE NEEDS

A custom design variation of the standard 6 in. unit includes an offset location for the *Spiralift* operating mechanism, allowing the cantilevered platform to rest at a lower position. (The only requirements for a recessed slab relate to the platform thickness and/or the dimensions of the tubular members of the scissor guides.)

Paco Corporation was developing a version of the 6 in. *Spiralift*, to be sold in Europe for accommodation of the physically disabled within the requirements of the newly enacted accessible standards similar to those of ADA and UFAS in the United States.

FEASIBILITY FOR THE COURTROOM ENVIRONMENT

A discussion was held with the design and engineering staff at Paco headquarters to determine whether it would be feasible to adapt a version of the 6 in. *Spiralift* for use in the witness box and Judge's bench in compliance with the new design criteria as indicated in the Mechanical Lift Analysis.

It was determined that a system design, using the *Spiralift*, can easily accommodate the recommended standard clear platform area dimensions of 3 ft by 5 ft.

Two design options were originally considered for use in the courtroom environment. Both would have the same operating components.

The first version would have the *Spiralift* element(s) located directly under the platform and would require the scissors guides for stability; and the second places it within a wall recess measuring approximately 20 in. by 20 in., offset from the platform, which is supported on a cantilevered frame. (The configurations are similar to Scissors Lift and Cantilevered Platform Lift illustrated in Section One of the Mechanical Lift Analysis.)

The former would require a recessed area in the slab 9 ¾ in. deep to accommodate the *Spiralift* mechanism directly under the platform; and the remainder of the recess area for the platform would be 2 in. deep, which would allow the top of the platform in the resting position to be flush with the courtroom well finished floor.

The latter would require the entire pit to be approximately 2 in. deep because only the platform thickness needs to be accommodated.

Either of the configurations would support 3,500 lbs of weight.

A tour of the manufacturing facility was conducted and photographs from observations along the route through the production area are included as attachments to this supplement.

NEW DESIGN

Recent developments in technology at Paco have resulted in a new version of the basic lifting apparatus called the *Tandem SR*. This product includes two rigid column *Spiralifts* and is design specifically to accommodate concentrated loading for short intervals of travel. The lift apparatus is located directly under the platform but the steel scissors elements for stability and guidance are not required due to incorporation of the new mechanically interlocked bands within the lifting column, as illustrated in the rigid column details at the end of this section.

The new system should be available for purchase late in 2005. The anticipated cost for the lifting equipment and controls is targeted between \$5,000 and \$7,000. (This price does not include the platform, finish materials, or the installation costs.)

The recess slab conditions allowing the platform to be level with the courtroom well in the resting position would include an approximate depth of 9 ¾ in. to accommodate the lifting equipment and 2 in. for the platform depth. Design standards for the platform size (approximately 3 ft. by 5 ft.), loading (2,000 lbs), and height (approximately 3 ft.) are well within the requirements for accommodating a disabled person in a wheeled chair. (See preliminary product literature, and an illustration indicating an installation within the courtroom parameters, provided at the end of this section.)

LIST OF ATTACHMENTS

- Mechanical Lift System Comparison (Table)
- Photograph of a typical 6 in. *Spiralift* being connected to installation plates
- Photograph of steel spring beginning to expand
- Photograph of the *Spiralift* for a custom 3 ft by 5 ft platform installation
- *Spiralift* system description (website attachment)
- *Spiralift* tubular thrust screw description
- 6 in. *Spiralift* (Next Generation) catalog photograph
- General specifications and additional photographs for the 6 in. *Spiralift*
- Plan and sections for a typical *Spiralift* design.
- Detail drawings
- Plan and sections for the offset cantilever concept
- *Spiralift Tandem SR* extended configuration diagram
- *Spiralift Tandem SR* details for the drive mechanism
- *Spiralift* rigid column details
- Illustration of the *Tandem SR* within the courtroom environment

PART 2 – EVALUATION OF PORTABLE RAMPS AT THE JURY BOX

PURPOSE OF THE SUPPLEMENT

The use of portable ramps as a means of access to the jury box was only briefly addressed in the original edition of the Mechanical Lift Analysis. Part 2 of this supplement focuses on the practicality, physical limitations, and best methods of providing this design concept.

OBSERVATIONS

The opposite extremes incorporating portable ramps into the design of the jury box observed during the tour of 20 different U.S. Courthouses for the Mechanical Lift Analysis were located in Phoenix, Arizona and Knoxville, Tennessee.

MANUAL RECONFIGURATION FOR ACCESSIBLE ACCOMMODATION

As in the case of the mechanical lift for the witness box and Judge's bench at the Phoenix U.S. Courthouse, the designer attempted to provide the components in a subtle sophisticated manner, but the construction details and execution did not effectively support the design intent.

The accessible means of getting into the jury box at this facility is provided by adapting a section of the raised circulation space adjacent to the first row of seats into a ramp configuration. The riser element at the edge of the raised floor is removed and recessed metal pulls, imbedded in the moveable section of carpeted floor, are extended and used to lower one end of the section to form a ramp.

The pulls are weak and poorly anchored into the plywood sub-flooring. Edge conditions of the movable section of flooring, plus the fixed floor opening, have frayed carpet conditions and the removable wood riser is not mechanically fastened to jury box base. (Refer to the photograph on Page 5-65 of the Mechanical Lift Analysis.)

Unlike the lift equipment adaptation at the witness box for this Courthouse, which required knowledge of the selected system limitations before providing the final millwork dimensions and details, this ramp condition should have been more substantially detailed in the construction documents prior to bidding.

This concept could be a good solution when it is properly designed, detailed and constructed.

MECHANICAL RECONFIGURATION FOR ACCESSIBLE ACCOMMODATION

The Knoxville U.S. Courthouse is provided with at least one electrically power mechanically retractable ramp at a jury box used to accommodate physically disabled jurors. The entire system fits under a 6in. raised portion of the jury box floor. The riser element opens and rotates on a spring integral with the hinge, allowing the ramp to slide out on guide rails and engage with the edge of the raised floor. The entire operation takes 15 seconds. (Refer to the photographs on Pages 5-39 and 5-40 of the Mechanical Lift Analysis.)

GENERAL ASSESSMENT

Both of these design concepts are appropriate when well-detailed and effectively integrated into the jury box. They both address the fundamental goal of providing a means of access for the physically disabled, occurring on a very infrequent basis, without requiring a fixed element (ramp) that takes away circulation space in the courtroom well area.

RECOMMENDATIONS

MINIMUM DESIGN CONSIDERATIONS (MANUAL RECONFIGURATION CONCEPT)

- Provide details for durable finished edge conditions on both the moveable floor element and the adjacent fixed floor opening.
- Specify two securely anchored collapsible pull devices rated for at least 100 lbs of weight each.
- Detail a hinged plate condition that pivots out when the floor section is lowered, to provide a smooth transition from the courtroom well over the raised edge of the lowered floor section.
- Specify a durable clipped connection between the removable riser section and the base of the jury box.

MINIMUM DESIGN CONSIDERATIONS (MECHANICAL RECONFIGURATION CONCEPT)

- Assure that proper clearance is provided for the fully-retracted ramp, guide rails, and drive mechanism within the floor framing configuration under the jury box.
- Confirm the width required for the finished opening when the ramp is selected and provide this information to the millwork contractor.
- Select appropriate finishes to be applied on the manufacturer's hinged riser element.
- Assure adequate maneuvering space for wheeled chairs when the ramp is extended.



Six-Inch Spiralift Being Connected to Installation

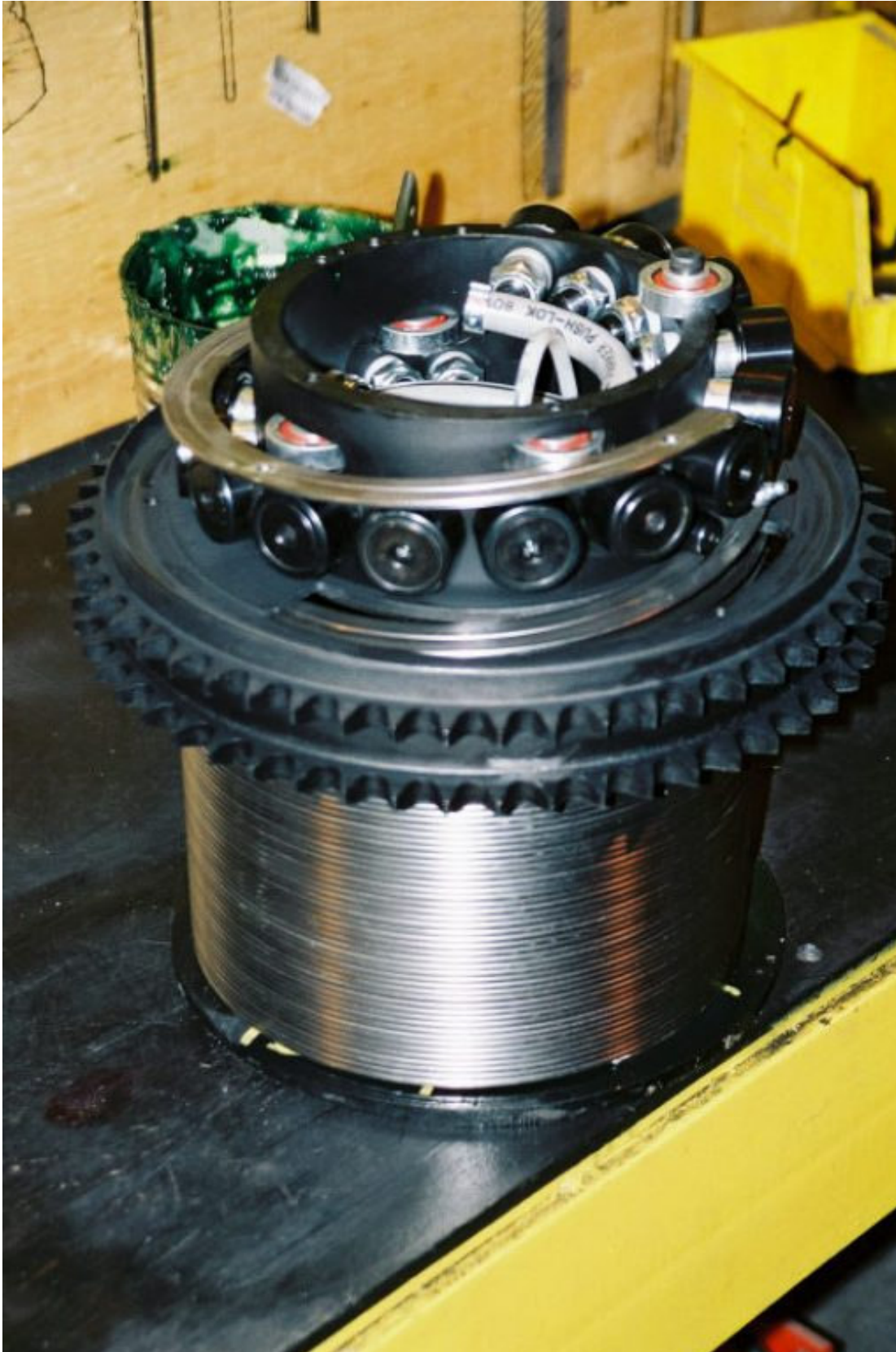

Steel Spring Being Expanded

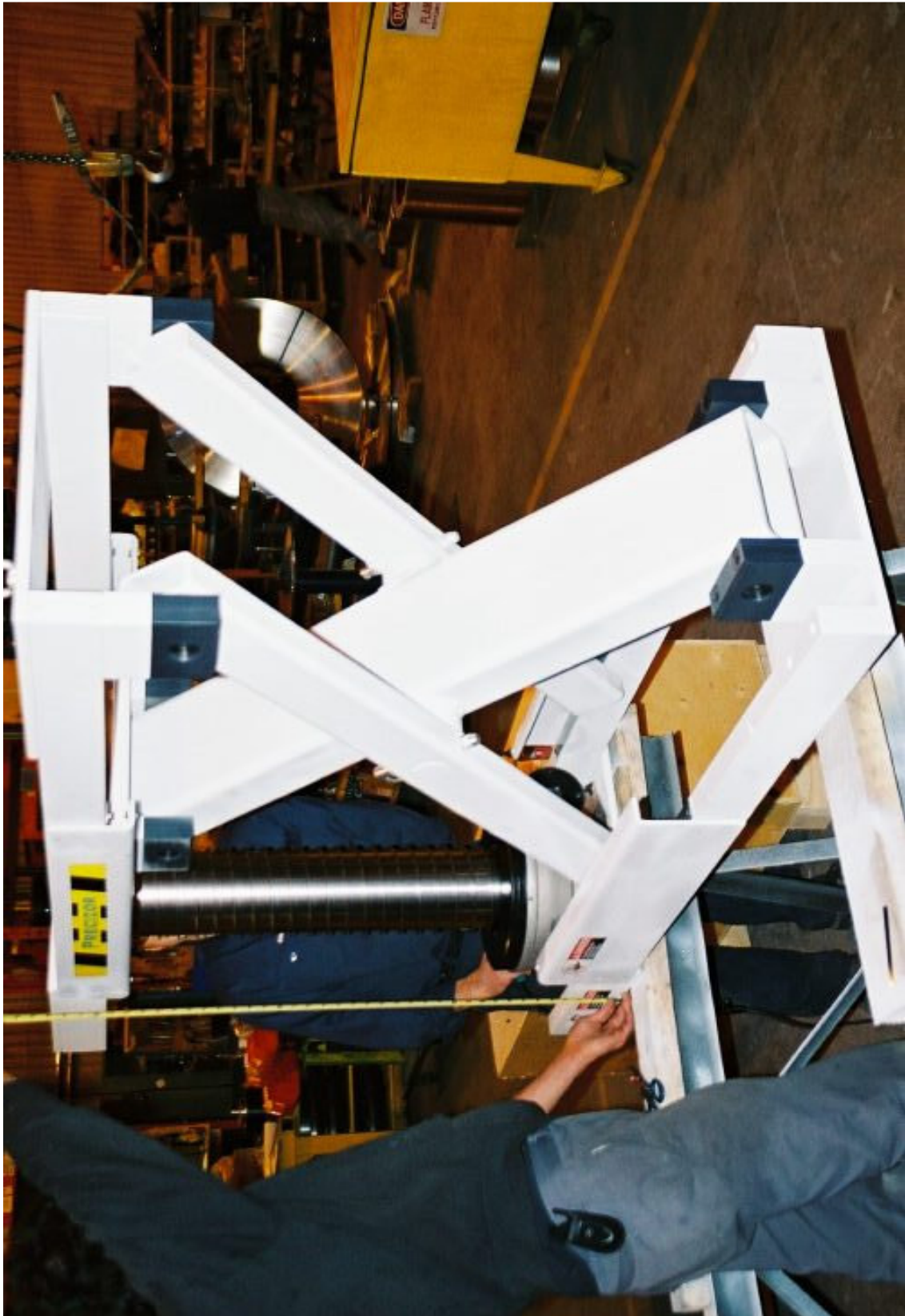

Six-Inch Spiralift and Scissors Guide for 3-Foot By 5-Foot Platform

MECHANICAL LIFT SYSTEMS COMPARISON

(INVESTIGATION BY HDR & LERCH / BATES)

EVALUATION CRITERIA:

MEETS BASIC REQUIREMENTS >

	SOUTHWORTH / T.L. SHIELD	GARAVENTA (GENESIS SERIES)	INCLINATOR	ACCESS INDUSTRIES	NATIONAL WHEEL-O-VATOR	ASCENSION	CONCORD	VERTICAL MOBILITY	GIANT LIFT	SPIRALIFT
STANDARD PRODUCTION SYSTEM:	SCISSORS PLATFORM	CANTILEVERED PLATFORM W/ TOWER OPERATION	CANTILEVERED PLATFORM W/ TOWER OPERATION	CANTILEVERED PLATFORM W/ TOWER OPERATION	CANTILEVERED PLATFORM W/ TOWER OPERATION	PORTABLE	CANTILEVERED PLATFORM W/ TOWER OPERATION	CANTILEVERED PLATFORM W/ TOWER OPERATION	CANTILEVERED PLATFORM W/ TOWER OPERATION	TUBULAR THRUST SCREW OPERATION
		INCLINED PLATFORMS			INCLINED PLATFORMS					DRIVE PLACED UNDER OR ALONG SIDE PLATFORM
					PORTABLE					
WILL THEY PROVIDE THEIR BASIC OPERATIONAL PLATFORM & DRIVE MECHANISM COORDINATED WITH A CUSTOM ENCLOSURE?	YES	YES	NO	YES	YES	NO	YES	YES	YES	YES
TYPE OF DRIVE MECHANISM:	HYDRAULIC	ACME SCREW	HYDRAULIC CHAIN	RECIRC. BALL SCREW	ACME SCREW	HYDRAULIC	CABLE HYDRAULIC	SCREW DRIVE	HYDRAULIC CHAIN	ELECTRIC WORM SCREW
		HYDRAULIC OPTION		ROPE HYDRAULIC OPTION						
IS THERE LEVELING ADJUSTMENT CAPABILITY? (WITHIN FRACTIONS OF AN INCH.)	YES	1/2" IN FIELD	YES	CAN BE MADE WITHIN 3/8"	CAN BE MADE WITHIN 3/8"	YES	YES	YES - LIMIT SWITCH ADJUSTMENTS	YES - LIMIT SWITCH ADJUSTMENTS	YES - LIMIT SWITCH ADJUSTMENTS
HAVE THEY EVER PROVIDED WITNESS BOX & JUDGE'S BENCH LIFT?	YES	YES	YES	YES	YES	1	YES	YES	YES	NO
HOW MANY INSTALLATIONS?	>200 (21 U.S. CTS)	>6	>5	>10	>200 (10 U.S. CTS.)	1	>10	>10	>10	0
ARE THEY DOING ANY PRODUCT REFINEMENTS / RESEARCH APPLICABLE TO THEIR LIFT DESIGN?	NO	NO	NO	NO	NO	NO	NO	NO	NO	YES
DO THEY PROVIDE A MODEL REQUIRING A PIT?	YES	YES	NO	YES	YES	N/A	YES	NO	YES	YES
DO THEY PROVIDE A MODEL WITHOUT A PIT REQUIREMENT?	YES	YES	YES	YES	YES	N/A	YES	YES	YES (3 1/4" RAMP ROD.)	NO
IS A PORTABLE UNIT AVAILABLE?	NO	NO	NO	YES (DOES NOT MEET ADA)	YES	YES (WILL MEET ADA)	YES	NO	NO	YES
WILL THEY BID ON LIFTS FOR COURTROOMS?	YES	YES	YES	YES	YES	NO	YES	YES	YES	YES
UNIFORMITY / CONSISTENCY OF PRODUCT (RANGE 1- 5) LOW - HIGH	5	5			5	N/A	2	N/A		
GENERAL INFORMATION	SOUTHWORTH MANUFACTURERS THE LIFT & T.L. SHIELD DOES ALL CONTROLS & INSTALLATION. CHECK VALVE CHANGED TO STOP "SINKING". RECOMMEND CHANGING THE SYSTEM TO "JACK". APPROVE ISSUE "NEW TECH." DESIGNATION.	WALL PANELS CAN BE ELIMINATED. EXCEPT ONE WITH CONTROLS & RAILING MOUNTED ON IT. HAVE USED INCLINED LIFT IN COURTROOM. NEED ACCESS TO TOP OF EQUIPMENT TOWER FOR SERVICE. TOWER HEIGHT IS 61 3/8".	TWO MODELS: (1) STEEL ENCLOSURE W/ 8" TOWER (2) INTEGRAL FIBERGLASS ENCLOSURE W/ 8" HIGH TOWER. (NOISE IS A FACTOR W/ THE STEEL UNIT.)	TWO MODELS: SHAFT MODEL & ENCLOSURE MODEL. CAN INCORPORATE CUSTOM MILLWORK.	THREE STOP LIFT - 24" W/ TOWER OF 45" HEIGHT. THEY DO NOT RECOMMEND USE OF THEIR PORTABLE LIFT IN COURTROOMS. FRONT OR BACK SERVICE ACCESS IS AVAILABLE.	NOT PRACTICAL FOR MANEUVERING IN A COURTROOM ENVIRONMENT.	BOTH FIXED OR PORTABLE UNITS ARE AVAILABLE.	THE STEP IS INTEGRAL W/ THE GATE.	INDUSTRIAL UNIT.	LIFTS ORIGINALLY DESIGNED FOR PERFORMANCE HALL STAGE, ORCHESTRA PLATFORM, AND SEATING CONFIGURATIONS. CURRENTLY DEVELOPING AN ACCESSIBLE LIFT DESIGN TO BE MARKETED IN EUROPE.
NOTE: NOT ALL MANUFACTURERS LISTED CAN PROVIDE LIFTS FOR A FREESTANDING WITNESS BOX OR JURY BOX DUE TO INFLEXIBILITY OF TOWER / MAST HEIGHT.										
CONTACTS	EVELLYN (NATIONAL) (616) 509-8228	CARY (INTERNATIONAL) (800) 663-6556	JEFF (NATIONAL) (800) 663-8007 ELEVATOR RAY CLARK (540) 651-9190	KEVIN DUNWORTHY AREA ACCESS FALLS CHURCH, VA. (703) 573-2111 (703) 207-9446 FAX	KEITH (NATIONAL) (800) 551-9095	LINDA GREEN (NATIONAL) (800) 459-0440	DONNA CONSOLIDATED ELEVATOR (703) 335-2510	JIM LEACH (937) 236-2888	DONNA (800) 52-GIANT	CHRIS SHAW (760) 798-8555



GALA SYSTEMS
CREATIVE SOLUTIONS

About Gala

Products & Services

Understage Systems

Spiralift
Orchestra Lifts
Turntable Systems
Matrixx Lift Tables

Motorized Rigging Systems

Modular Electric Vertilift®

Multipurpose Hall Systems

The Gala Venue
Multipurpose Halls
Seating Wagons

Customer Service

Customer Care

Installations

Gala News

Contact Us

Featured Presentations & Animations

[Home](#) | [Contact Us](#) | [Site Map](#)

SEARCH >>

Français |



Understage Systems

Spiralift

Gala's patented Spiralift tubular thrust screws drive all of our understage lift systems. They are engineered, built and factory tested to provide smooth, precise control.

Spiralift is:

- ▶ the world's best-selling understage lift;
- ▶ very compact when retracted, yet capable of high travels;
- ▶ easy to install and retrofit on any sound structural base - with no caissons;
- ▶ strong and stable to control exceptional loads precisely without tilt or rock;
- ▶ adaptable to any shape or load requirement; and
- ▶ reliable, based on hundreds of installations and constant use in demanding performance venues worldwide.



Creating a Column from a Spring...

Spiralift employs a coiled, flexible, flat steel spring that expands with the insertion of a vertically-oriented spiral steel band. The result is a stable, fully adjustable column formed continuously integrated, I-shaped sections.

Spiralifts are simple to install and operate. They do not require excavation, caissons or conventional hydraulic lifts do—so they can be placed easily on any sturdy, load-bearing no fluids to leak or contract, the columns are fully stable.

Spiralift units can be configured easily in modular designs to suit any platform geometry building architecture. Multiple units can be linked to the same drive train and fully sync. The linear actuators stop instantly and automatically if the load or mechanism becomes in any way. They require modest power and maintenance, yet provide substantial lift ca

Spiralift units are compact and exceptionally strong. They are available in a variety of sizes and 18" models* that serve varied height and load requirements. The smallest 6" / 150 mm can fit into a vertical space of only 8 1/2 in / 215 mm, yet can extend to 12 ft / 3.6 m and support up to 8,000 lbs / 35.6 kN. The popular 9" / 230 mm model is as small as 8 3/8 in / 213 mm when retracted up to 20 ft / 6 m when extended, and designed to support loads up to 22,500 lbs / 100 kN. The largest 18" / 455 mm* model has a 14 in / 355 mm high base that creates a 40 foot / 12 m column that sustains loads up to 40,000 lbs / 178 kN.

All of these features have made Spiralift the world's best selling high-efficiency stage air lift for new and retrofit theatre applications.

■ Technical Specifications

ND6 Spiralift (international)	ND6 Spiralift (imperial)	ND9 Spiralift (international)	ND9 Spiralift (imperial)	HD9 Spiralift (international)	HD9 Spiralift (imperial)	ND18 Spiralift (international)	ND18 Spi (imperi
Column diameter			230 mm				
Maximum lifting capacity			44.5 kN				
Sustained capacity at maximum lifting height			100 kN				
Maximum lifting travel			6 m				
Travel options *			0.6 m	1.5 m	3 m	4.5 m	6 m
Minimum closed height			230 mm	270 mm	368 mm	470 mm	572 mm
Shipping weight (without oil)			91 kg	103 kg	123 kg	143 kg	164 kg
Maximum lifting speed			9 m/min				
Drive options			Direct drive shaft or motor				
Lifting speed parameter * (@ 60 Hz)			1.8 m/min	3.6 m/min	5.5 m/min	7.3 m/min	
Input torque required to lift maximum load			16.27 Nm	27.10 Nm	39.20 Nm	50.70 Nm	
Lift travel per revolution (pitch)			52.9 mm				
Material column (vertical and horizontal band)			Stainless Steel 301				

* Consult Gala's main office for others options of travel.

NOTE: For specific applications of any of the Spiralift models, the Spiralift Technical Brochure must be consulted.

[Products & Services](#) [Installations](#) [Gala News](#)
[Contact us](#) [Featured Presentations & Animations](#)

[Privacy Policy](#) [Terms of Use](#) © 2003 GALA



GALA

THEATRICAL EQUIPMENT

A division of PACO CORP.

INNOVATIONS THAT LAST

SPIRALIFT[®]

Tubular Thrust Screw Description

The tubular thrust screw is a mechanical device used as a linear actuator. Linear vertical motion is achieved by using a coiled flat horizontal stainless steel band.

The horizontal stainless steel band **A** expands and a vertical stainless steel band **B** is inserted. The heart of the tubular thrust screw is a drum shaped rotor **C** which rotates on a thrust bearing. The vertical band is stored in a rotating magazine **D** surrounding the rotor and the horizontal band is stored at the base of the assembly. A sloped set of 16 steel cam roller bearings **E** attached to the rotor in a helix pattern lift the horizontal coil and provides a space for the vertical band. Rotating the double chain sprocket **F** of the tubular thrust screw causes rotation of the rotor with the attached cam rollers mounted in a helix. The cam rollers raise the horizontal band and create an opening so that the vertical band can be inserted without friction between the coils of the horizontal band into the groove located at the center of the horizontal band. This assembly of bands is forced upwards with a continual turning motion of the rotor. The result is a stable fully adjustable column **G** formed of continuously integrated "I" shaped sections.

The column is continuously formed and can go as high as there is horizontal and vertical band to feed the column assembly. When the rotor is driven in the opposite direction, the process is reversed and the column is lowered.

The vertical band is returned to the rotating magazine surrounding the rotor and the horizontal band is returned to the base of the assembly.

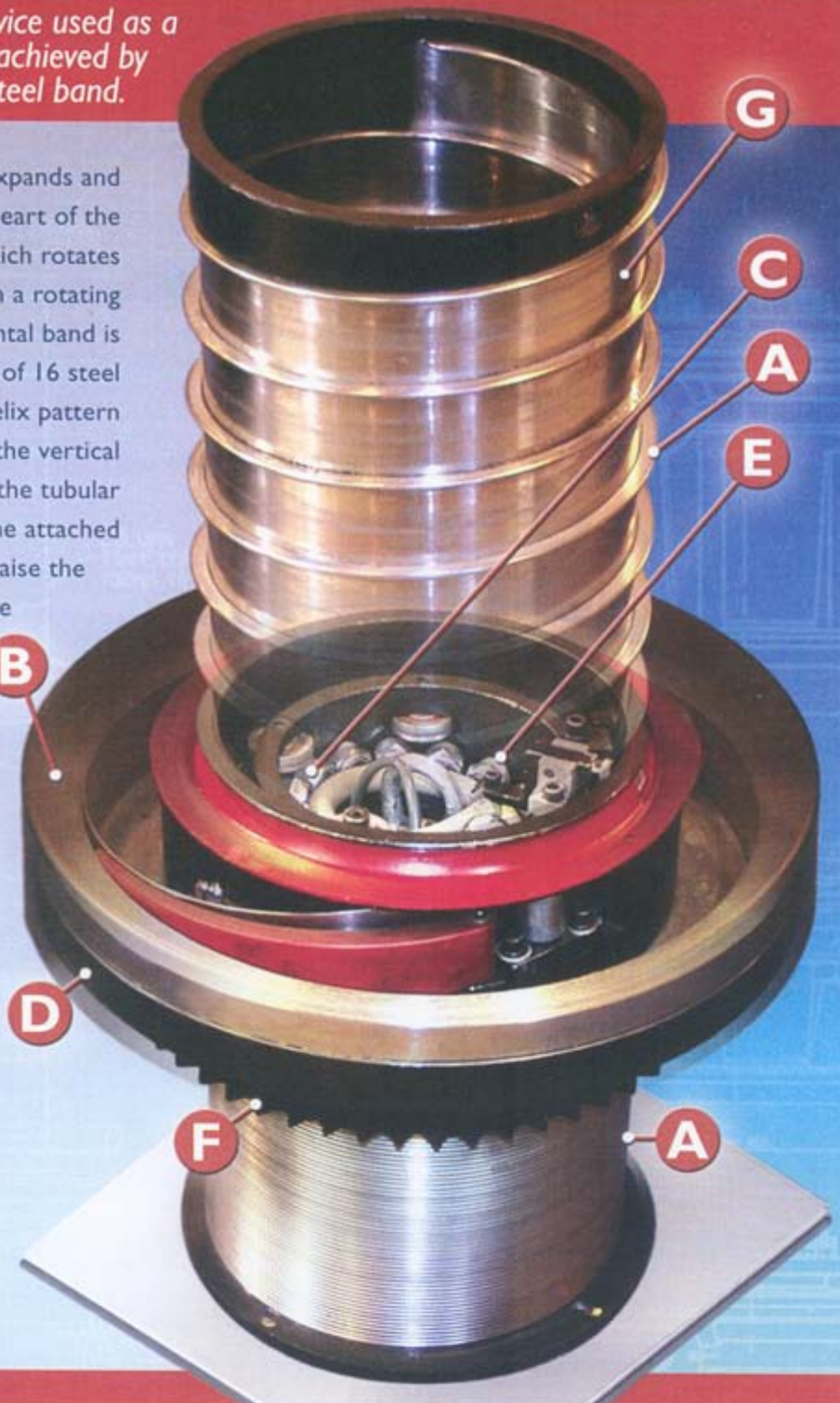

6" Spiralift[®]

Next Generation Spiralift



Patent Pending

Typical applications

Seating Riser Lift

Piano Lift

Podium Lift

Compensating Lift

Chorus Lift

Trap Lift

Handicap Lift

Small Stage Lift

Orchestra Lift

GALA
THEATRICAL EQUIPMENT
A division of PACO CORP.

Innovations that last.

6" Spiralift®

GENERAL SPECIFICATIONS

	IMPERIAL				INTERNATIONAL			
The 6" Spiralift								
Column diameter	6 inches				152 mm			
Maximum lifting capacity	4,000 pounds				17,80 kN			
Sustained capacity at maximum lifting height	8,000 pounds				35,60 kN			
Maximum lifting Travel	126 inches				3,2 m			
Travel options	4'	7'	10.5'		1,22 m	2,13 m	3,2 m	
Unit closed height	9 3/4"	13 1/2"	16 3/4"		248 mm	343 mm	426 mm	
Shipping weight	40 lbs	45 lbs	55 lbs		18 kg	20 kg	25 kg	
Maximum lifting speed	23 ft./min.				0,116 m/s			
Drive options	Direct drive shaft or motor				Direct drive shaft or motor			
Lifting speed parameter (@ 1 750 RPM)	6 ft/min	12 ft/min	18 ft/min	23 ft/min	0,03 m/s	0,06 m/s	0,091 m/s	0,116 m/s
Torque required to lift maximum load	44 lb-in	73 lb-in	106 lb-in	136 lb-in	4,9 Nm	8,2 Nm	11,9 Nm	15,4 Nm
Lift travel per revolution (pitch)	1.295 inches				33 mm			
Material column (vertical and horizontal band)	Stainless Steel 301				Stainless Steel 301			

- **Unit closed height: 9 3/4 in.**
- **Cast aluminium housing**
- **Stainless steel column**

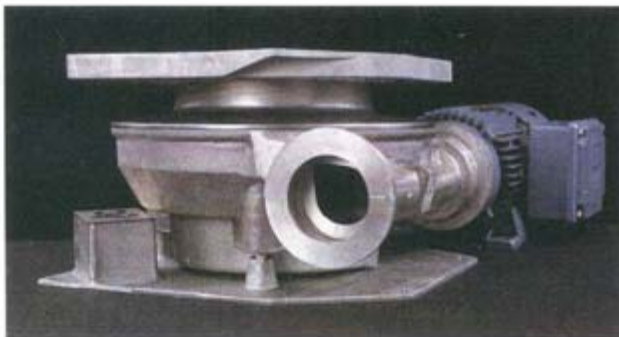

Please contact us for a visit of our plant. You can reach us in our offices at:

Head Office: 3185 First Street, St. Hubert, Quebec, Canada J3Y 8Y6 • Tel.: +1 450 678 7226 • Fax: +1 450 678 4060
E-MAIL: info@galainfo.com – **Web Site: www.galainfo.com**

North American Office: 655 Calle Ladera, Escondido, CA, USA 92025 • Tel.: +1 760 738 5555 • Fax: +1 760 738 5...
E-MAIL: cshaw@galainfo.com

German Office: Schönbergstr. 7 B, D-85057 Ingolstadt, Germany • Tel.: +49 841 981927 0
Fax: +49 841 981927 1 • E-MAIL: nzepter@galainfo.com

Japan Office: 4-17-3 Nakazuma, Ageo City, Saitama Prefecture, Japan 362-0072
Tel.: +81 (0)48 771 3466 • Fax: +81 (0)48 771 3504 • E-MAIL: nakajima-yos@galainfo.com

Drawings

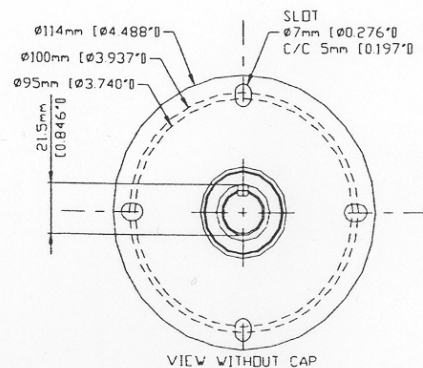
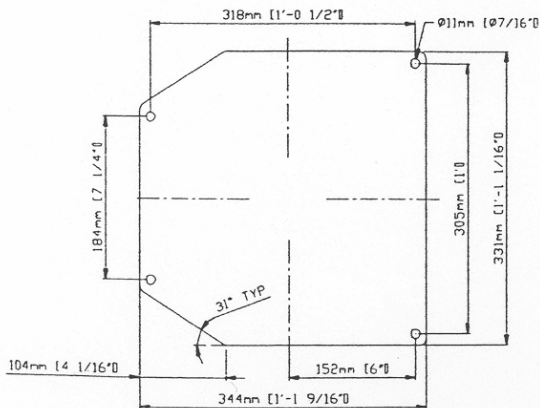
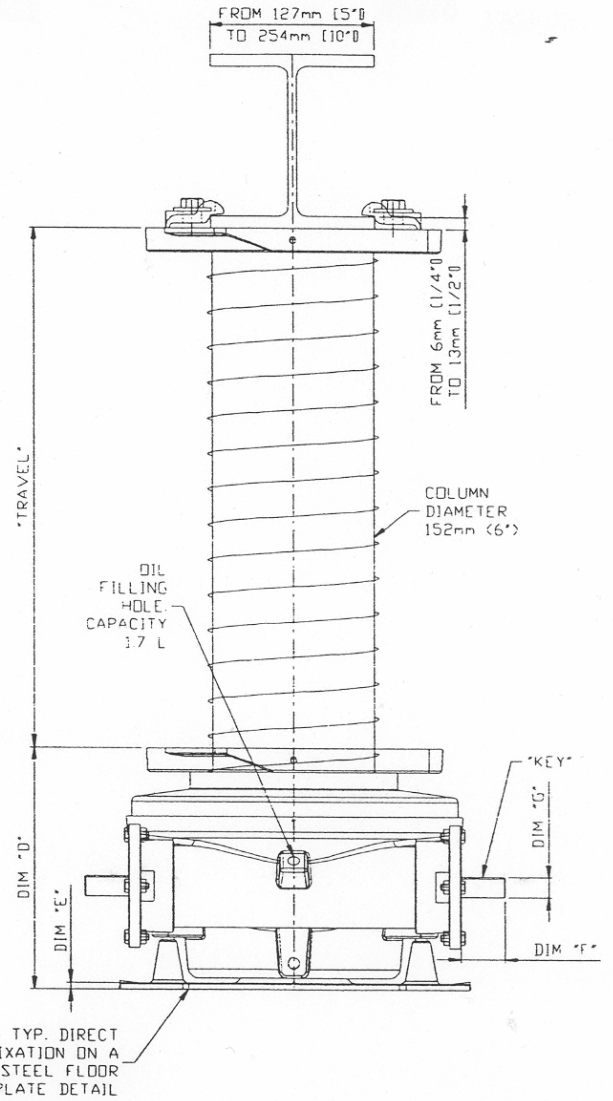
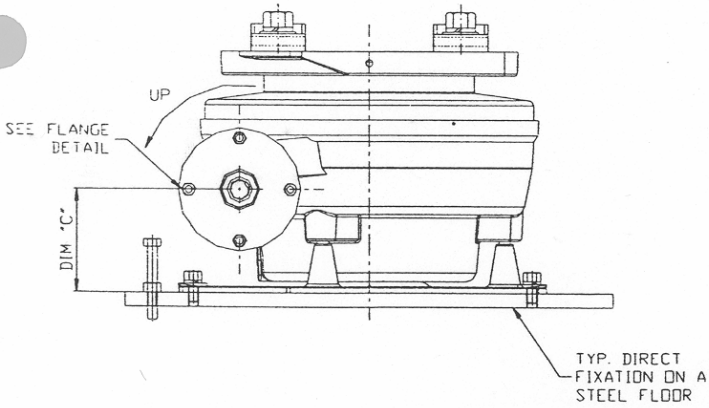
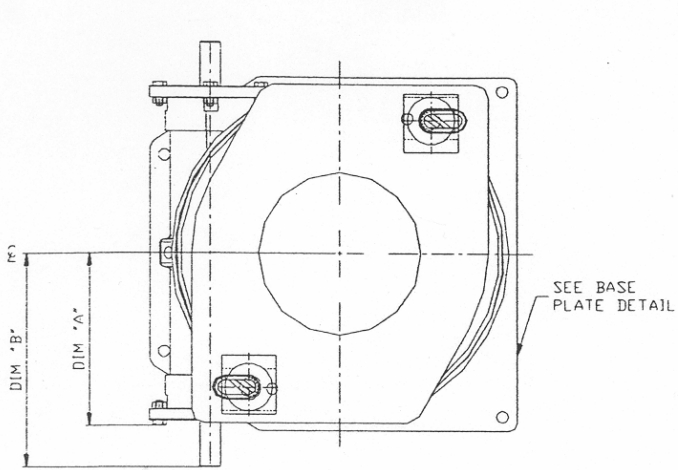

PLAN SHOWING
OFFSET SPIRALIFT LOCATION

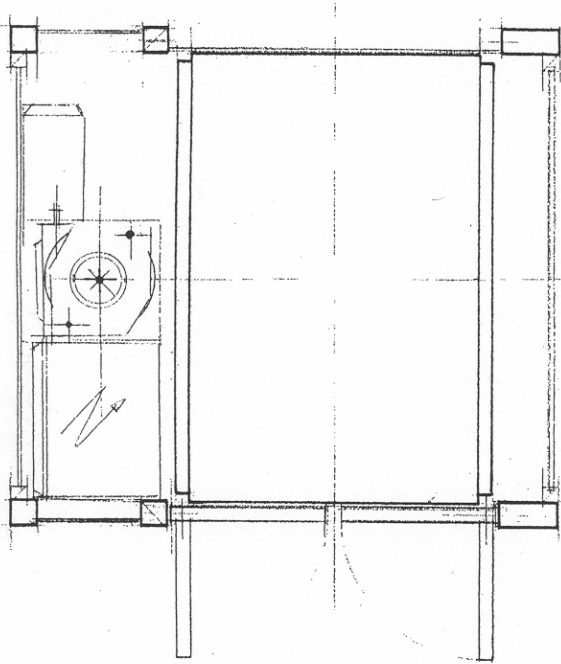

PLAN SHOWING CANILEVERED FRAME
ATTACHED TO THE SPIRALIFT
SUPPORTING THE PLATFORM

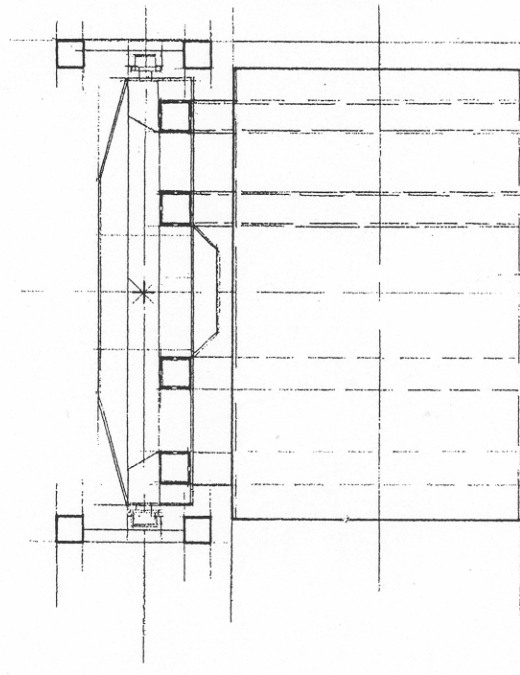

SECTION AT FRAMING

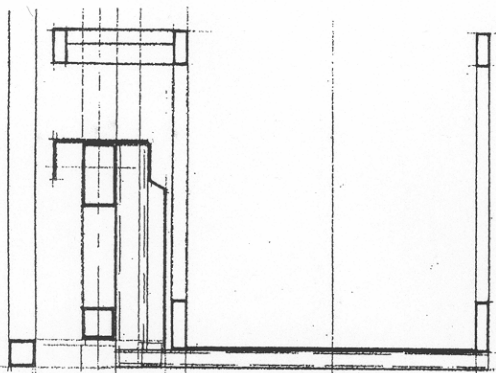

SECTION AT SPIRALIFT

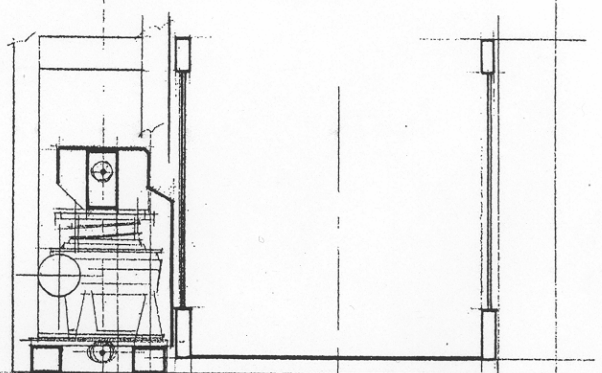

DESIGN CONCEPT - OFFSET SPIRALIFT LOCATION



PACO

Spiralift

TANDEM SR

LÉGER / LIGHT
ADAPTABLE / CUSTOMIZABLE
SANS CISEAUX / SCISSORLESS

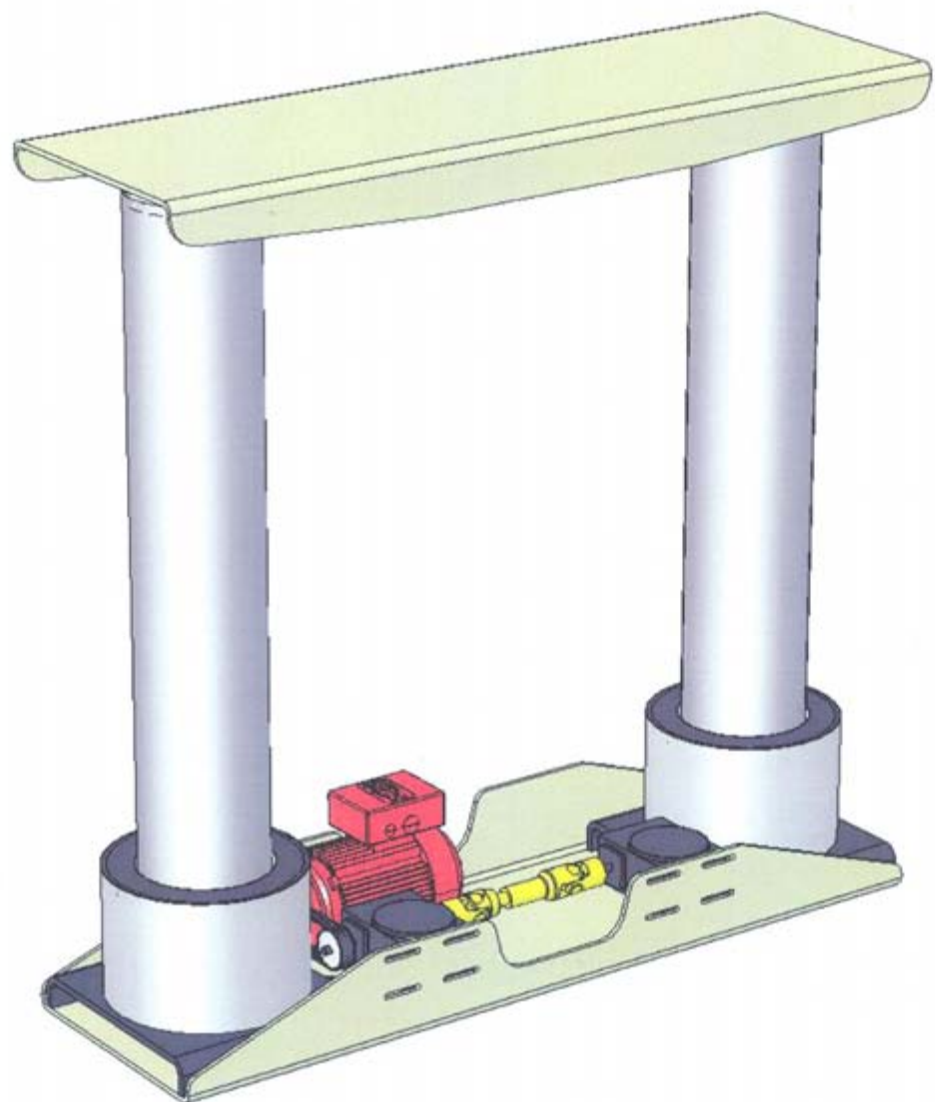

spiralift@pacocorp.com



PACO

Spiralift

TANDEM SR

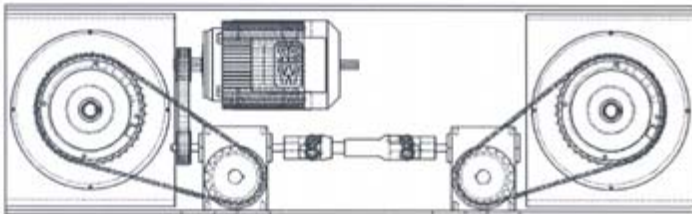
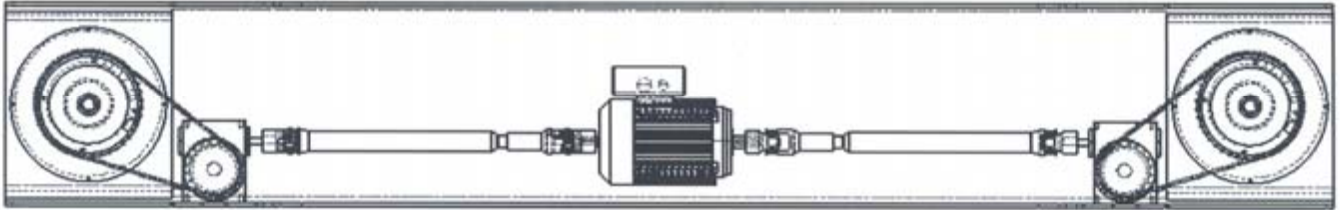

COURT OU LONG
SHORT OR LONG
18''x 60'' @ ...
3000 lbs @ ...

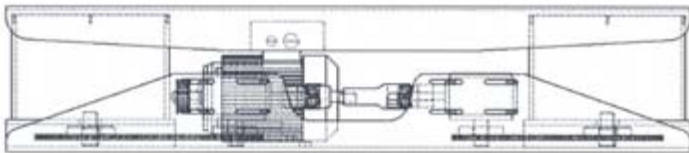

... DOUBLE TANDEM

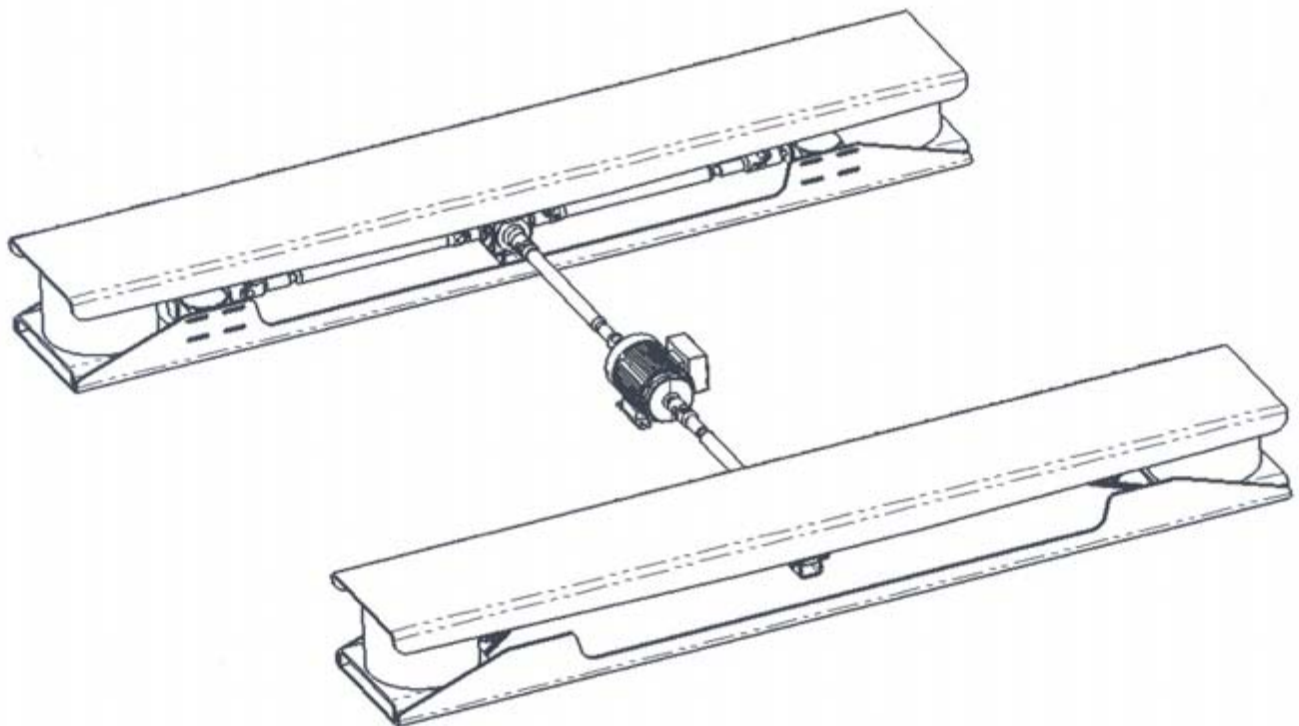



PACO

Spiralift

Introducing Our New Rigid Column Technology

Rigid Column Technology

MECHANICALLY INTERLOCKED BANDS PROVIDE
SELF-GUIDED RIGID LIFT COLUMN

[New Features]

- True 'push-pull' actuator
- Self-guided lift column
- Closed height to travel ratio of up to 1:20
- Self-locking in any direction, speed or travel height
- Quiet, fast travel speeds
- Readily uses standard brakeless AC, DC, servo, pneumatic or other motors
- Economical, easy to install and maintenance free duty life

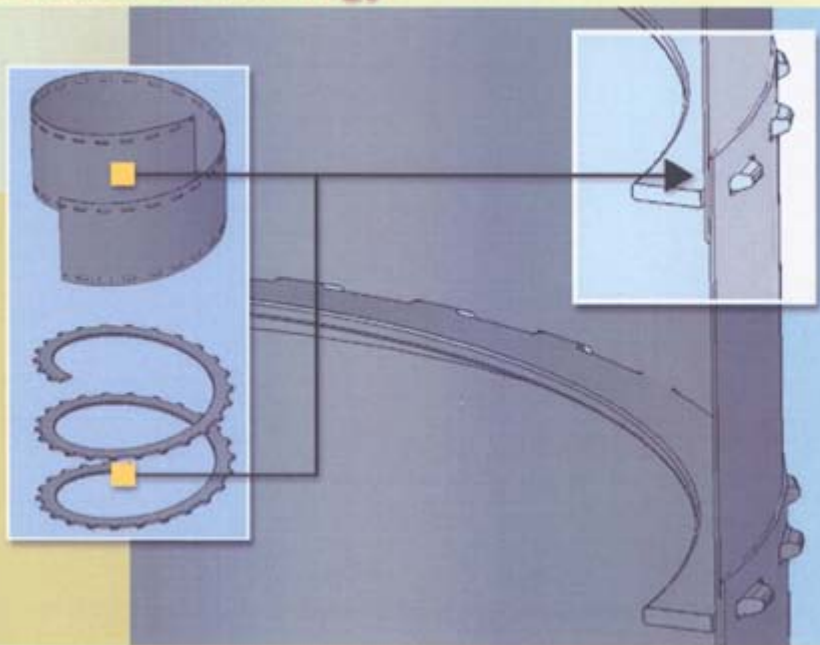

Self-guided Lift Table Concept

Our new rigid column technology makes possible the design of inexpensive ergonomic lift tables (see sketch) offering all of the advantages of high-end mechanical tables such as:

[Advantages]

- 100% mechanical operation
- Precise and repeatable load indexing
- Hydraulic free
- Stable, will not sag or bounce
- Maintenance-free duty life

Dimensions: 1 m W x 2 m L*
 Typical Travel: 1 m
 Capacity: 1 metric ton
 Travel Speed: + 30 ft./min.
 Closed Height: 300 mm
 Duty Life: 50,000 cycles

[SELF-GUIDED SR6 SPIRALIFT]

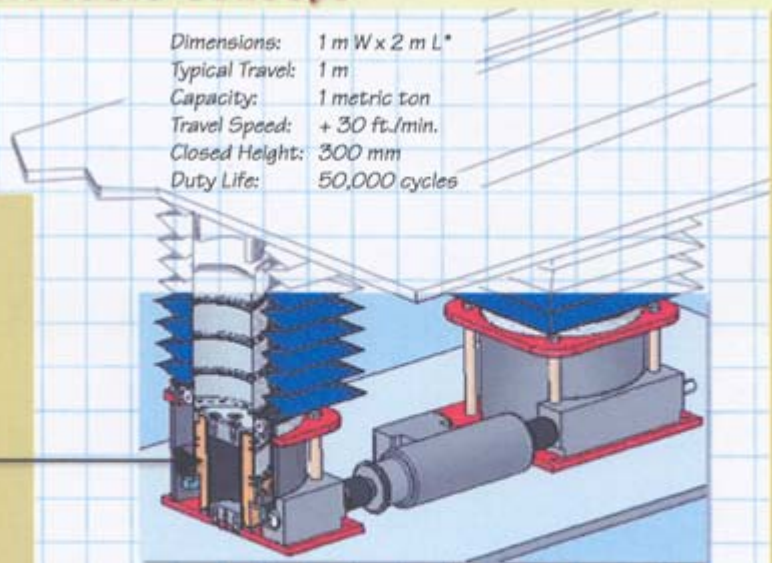

* For illustration purpose only.

Please contact us to obtain more information on the new rigid column technology.

3185 FIRST STREET, ST. HUBERT, QC J3Y 8Y6 CANADA

TELEPHONE: +1 450 678-7226 FAX: +1 450 678-4060 N. AMERICA ONLY: 1 800 463-7226 INFO@PACOCORP.COM WWW.PACOCORP.COM

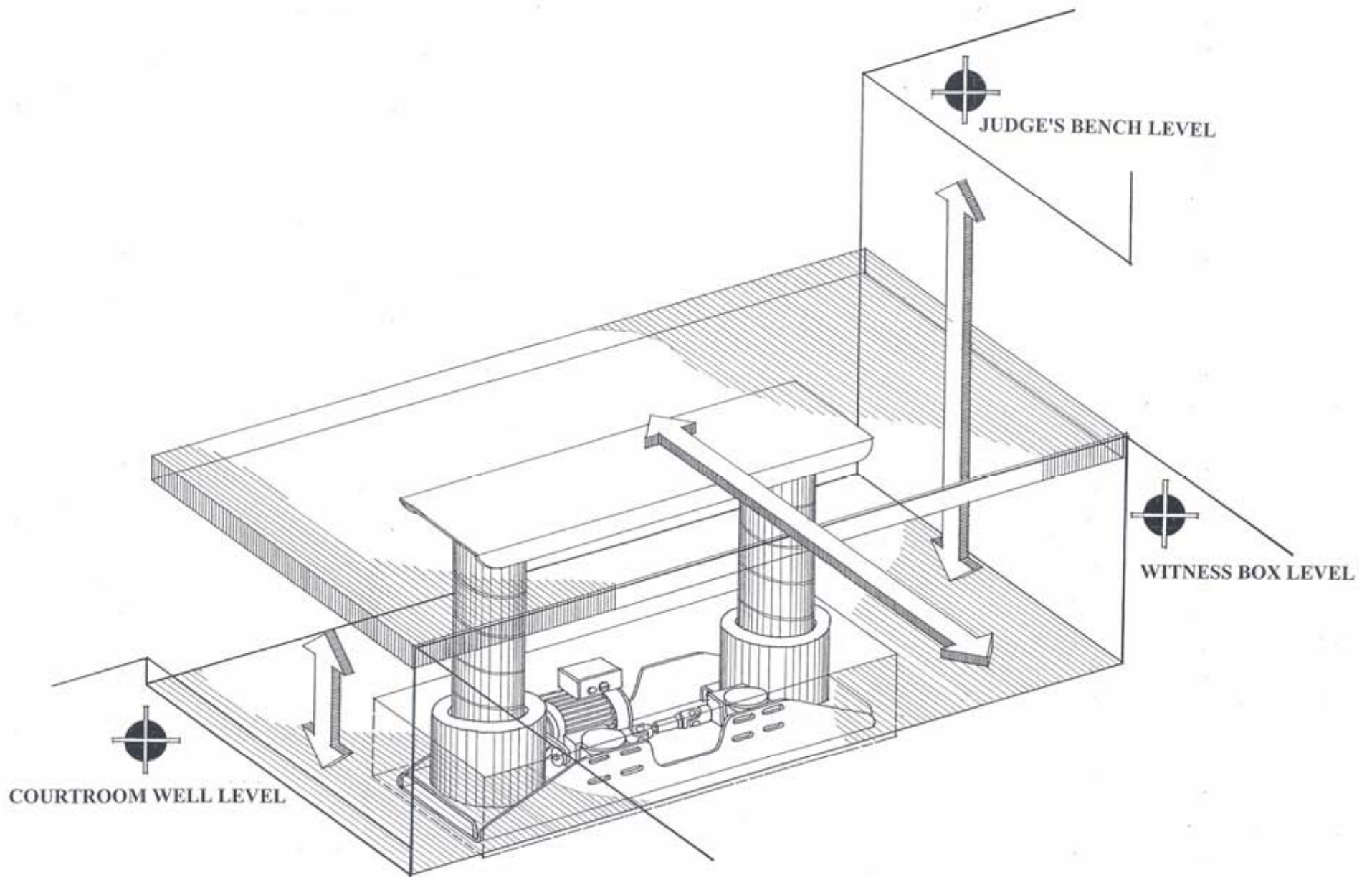

Spiralift Tandem SR Courthouse Application