

UNIFIED FACILITIES CRITERIA (UFC)

MASONRY STRUCTURAL DESIGN FOR BUILDINGS



APPROVED FOR PUBLIC RELEASE; DISTRIBUTION UNLIMITED

UNIFIED FACILITIES CRITERIA (UFC)

MASONRY STRUCTURAL DESIGN FOR BUILDINGS

Any copyrighted material included in this UFC is identified at its point of use. Use of the copyrighted material apart from this UFC must have the permission of the copyright holder.

U.S. ARMY CORPS OF ENGINEERS (Preparing Activity)

NAVAL FACILITIES ENGINEERING COMMAND

AIR FORCE CIVIL ENGINEER SUPPORT AGENCY

Record of Changes (changes are indicated by \1\ ... /1/)

Change No.	Date	Location

This UFC supersedes TM 5-809-3, dated 30 October 1992. The format of this UFC does not conform to UFC 1-300-01; however, the format will be adjusted to conform at the next revision. The body of this UFC is the previous TM 5-809-3, dated 30 October 1992.

FOREWORD

\1\

The Unified Facilities Criteria (UFC) system is prescribed by MIL-STD 3007 and provides planning, design, construction, sustainment, restoration, and modernization criteria, and applies to the Military Departments, the Defense Agencies, and the DoD Field Activities in accordance with [USD\(AT&L\) Memorandum](#) dated 29 May 2002. UFC will be used for all DoD projects and work for other customers where appropriate. All construction outside of the United States is also governed by Status of forces Agreements (SOFA), Host Nation Funded Construction Agreements (HNFA), and in some instances, Bilateral Infrastructure Agreements (BIA.) Therefore, the acquisition team must ensure compliance with the more stringent of the UFC, the SOFA, the HNFA, and the BIA, as applicable.

UFC are living documents and will be periodically reviewed, updated, and made available to users as part of the Services' responsibility for providing technical criteria for military construction. Headquarters, U.S. Army Corps of Engineers (HQUSACE), Naval Facilities Engineering Command (NAVFAC), and Air Force Civil Engineer Support Agency (AFCEA) are responsible for administration of the UFC system. Defense agencies should contact the preparing service for document interpretation and improvements. Technical content of UFC is the responsibility of the cognizant DoD working group. Recommended changes with supporting rationale should be sent to the respective service proponent office by the following electronic form: [Criteria Change Request \(CCR\)](#). The form is also accessible from the Internet sites listed below.

UFC are effective upon issuance and are distributed only in electronic media from the following source:

- Whole Building Design Guide web site <http://dod.wbdg.org/>.

Hard copies of UFC printed from electronic media should be checked against the current electronic version prior to use to ensure that they are current.

AUTHORIZED BY:

DONALD L. BASHAM, P.E.
Chief, Engineering and Construction
U.S. Army Corps of Engineers

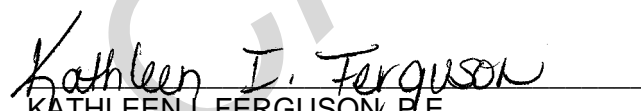
KATHLEEN I. FERGUSON, P.E.
The Deputy Civil Engineer
DCS/Installations & Logistics
Department of the Air Force

DR. JAMES W. WRIGHT, P.E.
Chief Engineer
Naval Facilities Engineering Command

Dr. GET W. MOY, P.E.
Director, Installations Requirements and
Management
Office of the Deputy Under Secretary of Defense
(Installations and Environment)

**ARMY TM 5-809-3
NAVY NAVFAC DM-2.9
AIR FORCE AFM 88-3, Chap. 3**

**MASONRY
STRUCTURAL DESIGN
FOR BUILDINGS**

APPROVED FOR PUBLIC RELEASE; DISTRIBUTION IS UNLIMITED

**DEPARTMENTS OF THE ARMY, THE NAVY, AND THE AIR FORCE
OCTOBER 1992**

REPRODUCTION AUTHORIZATION/RESTRICTIONS

This manual has been prepared by or for the Government and, except to the extent indicated below, is public property and not subject to copyright.

Copyrighted material included in the manual has been used with the knowledge and permission of the proprietors and is acknowledged as such at point of use. Anyone wishing to make further use of any copyrighted material, by itself and apart from this text, should seek necessary permission directly from the proprietors.

Reprint or republications of this manual should include a credit substantially as follows: "Joint Departments of the Army, Navy, and Air Force, TM 5-809-3/NAVFAC DM-2.9/AFM 88-3, Chap. 3, Masonry Structural Design for Buildings.

If the reprint or republication includes copyrighted material, the credit should also state: "Anyone wishing to make further use of copyrighted material, by itself and apart from this text, should seek necessary permission directly from the proprietor."

CANCELLED

MASONRY STRUCTURAL DESIGN FOR BUILDINGS

CHAPTER		Paragraph	Page
1.	INTRODUCTION		
	Purpose	1-1	1-4
	Scope	1-2	1-1
	References	1-3	1-1
2.	QUALITY ASSURANCE IN MASONRY		
	Introduction	2-1	2-1
	Design/Construction Process Overview	2-2	2-1
	Role of Design Engineer	2-3	2-1
3.	MATERIALS, PROPERTIES, STANDARD TESTS AND EFFLORESCENCE		
	Introduction	3-1	3-1
	Clay Masonry Units	3-2	3-1
	Concrete Masonry Units	3-3	3-2
	Mortar	3-4	3-4
	Grout	3-5	3-6
	Reinforcement	3-6	3-7
	Standard Tests	3-7	3-7
	Efflorescence	3-8	3-8
4.	DESIGN FOR CRACK CONTROL		
	Introduction	4-1	4-1
	Concrete Masonry Walls	4-2	4-1
	Brick Walls	4-3	4-2
	Anchored Veneers	4-4	4-3
	Composite Walls	4-5	4-3
	Isolation of Nonstructural Partitions	4-6	4-3
	Shelf Angles	4-7	4-3
	Other Than Running Bond Masonry	4-8	4-3
5.	GENERAL CRITERIA FOR REINFORCED MASONRY		
	Introduction	5-1	5-1
	Working Stress Assumptions	5-2	5-1
	Structural Properties	5-3	5-1
	Working Stress Design Equations	5-4	5-5
	Allowable Working Stresses	5-5	5-8
	Basic Reinforcement Requirements	5-6	5-10
	Connections Between Elements	5-7	5-11
6.	REINFORCED MASONRY WALLS		
	Introduction	6-1	6-1
	Design Loadings	6-2	6-1
	Structural Behavior	6-3	6-1
	Wall Design Equations	6-4	6-1
	P-Delta Effect	6-5	6-4
	Walls With Openings	6-6	6-4
	Design Aids	6-7	6-4
	Design Examples	6-5	6-4
7.	REINFORCED MASONRY SHEAR WALLS		
	Introduction	7-1	7-1
	General	7-2	7-1
	Allowable Shear Stresses	7-3	7-1
	Design Considerations	7-4	7-2
	Rigidity	7-5	7-3
	Distribution of Forces to Shear Walls	7-6	7-4
	Effects of Openings in Shear Walls	7-7	7-4

*This manual supersedes TM 5-809-3/NAVFAC DM-2.9/AFM 88-3, Chapter 3 dated August 1982

		Paragraph	Page
	Shear Wall Rigidity Analysis	7-5	7-6
	Design Examples	7-9	7-8
CHAPTER	8. LINTELS		
	Introduction	8-1	8-1
	Loading	8-2	8-1
	Allowable Deflection	8-3	8-1
	Masonry Lintel Deflections	8-4	8-1
	Bearing Pressure at Lintel Reaction	8-5	8-2
	Lateral Support	8-6	8-3
	Design Aids	8-7	8-3
	Design Examples	8-8	8-3
	9. COLUMNS AND PILASTERS		
	Introduction	9-1	9-1
	Minimum Requirements	9-2	9-1
	Loadings	9-3	9-2
	General Behavior	9-4	9-4
	Design Procedures	9-5	9-5
	Design Example	9-6	9-8
	10. NONDESTRUCTIVE EVALUATION TECHNIQUES		
	Introduction	10-1	10-1
	Background	10-2	10-1
	NDE Methods	10-3	10-1
	Applications of Combined Techniques	10-4	10-1
	NDE Tests	10-5	10-1
	Advantages and Disadvantages of all NDE Tests	10-6	10-11
APPENDIX	A: REFERENCES		A-1
	B: DESIGN AIDS FOR REINFORCED MASONRY WALLS		B-1
	C: LINTEL DESIGN AIDS		C-1
BIBLIOGRAPHY			Bibliography 1

LIST OF FIGURES

Figure	3-1. Typical Clay Masonry Units.
	3-2. Examples of Concrete Masonry Units.
	3-3. Strength of Mortar PSI Versus Constituent Proportions.
	3-4. Masonry Wall Flexure.
	3-5. Masonry Stress-Strain Curve.
	5-1. Open-End Unit 8 in X 8 in X 16 in.
	5-2. Assumed Dimensions and Effective Areas of Hollow Masonry.
	5-3. Working Stress Flexural Design Assumptions for Rectangular Sections.
	5-4. Working Stress Flexural Design Assumptions for T-Sections.
	5-5. Effective Embedment, l_e and edge distance, l_{be} .
	6-1. Wall Loading, Moment and Deflection Diagrams-Wind and Axial load Moments Additive.
	6-2. Wall Loading, Moment and Deflection Diagrams-Wind and Axial load Moments not Additive.
	6-3. Example 3 Wall Elevation.
	6-4. Section A through Wall Stiffener.
	7-1. M/Vd Ratios for Shear Walls.
	7-2. Shear Wall Deformations.
	7-3. Deformation of Shear Wall With Openings.
	7-4. Relative Rigidities of Piers and Spandrels.
	7-5a. Wall Deflection Chart.
	7-5b. Wall Deflection Chart.
	7-6. Design Example 1 Wall Elevation.
	7-7. Design Example 2 Wall Elevation.
	8-1. Triangular and Concentrated Loading on Lintels.
	8-2. Example 1 Wall Elevation.
	8-3. Example 1 Lintel Cross Section.
	8-4. Example 2 Wall Elevation.
	8-5. Example 2 Lintel Cross Section.
	8-6. Example 3 Wall Elevation.
	8-7. Example 3 Lintel Cross Section.
	8-8. Dead Load Shear and Moment Diagrams.
	8-9. Live Load Shear and Moment Diagrams.
	8-10. Location of Web Reinforcing in Lintel.
	9-1. Isolated Concrete Masonry Column.
	9-2. Concrete Masonry Pilaster with Continuous Bond Beam.
	9-3. Uncracked Section.

LIST OF FIGURES (Cont'd)

Figure	9-4.	Cracked Section.
	9-5.	Reaction Locations of Beams and Trusses.
	9-6.	Load Carrying Capacities of Columns vs. K_h/r .
	9-7.	Trial Section.
	10-1.	Prism Compressive Strength vs. Rebound Number.
	10-2.	Masonry Deformations Around Flatjack Slot During In-Situ Stress Test.
	10-3.	Stress-Strain Curve Obtained During In-Situ Deformability Test.
	10-4.	Setup For Modified In-Plane Shear Test.
	10-5.	Typical Ultrasonic Test Configurations.
	10-6.	Three Dimensional Surface Representing Through-wall Ultrasonic Pulse Arrival Time.
	10-7.	Mechanical Pulse Testing Apparatus.
	10-8.	Pulse Path Length vs. Arrival Time.

LIST OF TABLES

Table	3-1.	Durability.
	4-1.	Recommended Control Joint Spacing and Locations.
	4-2.	Maximum Spacing of Vertical Expansion Joints in Brick Walls, $\Delta T = 1000$.
	5-1.	Assumed Dimensions of Hollow Concrete Masonry Units and Associated Dimensions, Inches.
	5-2.	Equivalent Wall Thickness for Computing Compression and Shear Stress Parallel to the Wall for Hollow Concrete Masonry Units, Inches.
	5-3.	Area Effective in Axial Compression and in In-Plane Shear, A_g , in ² /ft.
	5-4.	Gross Moment of Inertia and Cracking Moment Strength for Various Widths of CMU Walls. Type S Mortar, $f'_m = 1350$.
	5-5.	Weight of CMU Walls, w_2 , Pounds Per Square Foot.
	5-6.	Gross Areas, Net Areas and Average Weights of Concrete Masonry Units.
	5-7.	Allowable Working Stresses in Reinforced Masonry.
	5-8.	Allowable Working Stresses for Grade 60 Reinforcing Bars.
	5-9.	Balanced Reinforcing Steel Ratio Along With k and j for Fully Grouted CMU in Running Bond. $f_y = 60,000$ psi.
	5-10.	Balanced Reinforcing Steel, One Bar Per Cell, Fully Grouted CMU Walls in Running Bond. f'_m 1350 psi, $f_y = 60,000$ psi.
	5-11.	Balanced Reinforcing Steel, Two Bars Per Cell, Fully Grouted CMU Walls. $f'_m = 1350$ psi, $f_y = 60,000$ psi.
	5-12.	Allowable Tension in Bolts, B_a , in Pounds, Based on the Compressive Strength of Masonry.
	5-13.	Allowable Tension in Bolts, B_a , in Pounds, Based on a Steel Yield Strength of 36,000 psi.
	5-14.	Allowable Shear, B_v , in Pounds, Based On the Listed Values of f'_m and a Steel Yield Strength of 36,000 psi.
	7-1.	Centroid and Moment of Inertia of Net Wall Section.
	9-1.	K factors for Columns and Pilasters.
	10-1.	Use of NDE Methods.
	B-1.	Properties of Wall Stiffeners With One Reinforcing Bar in Each Reinforced Cell, 6 in CMU, Type S Mortar.
	B-2.	Properties of Wall Stiffeners With One Reinforcing Bar in Each Reinforced Cell, 8 in CMU, Type S Mortar.
	B-3.	Properties of Wall Stiffeners With One Reinforcing Bar in Each Reinforced Cell, 10 in CMU, Type S Mortar.
	B-4.	Properties of Wall Stiffeners With One Reinforcing Bar in Each Reinforced Cell, 12 in CMU, Type S Mortar.
	B-5.	Properties of Wall Stiffeners With Two Reinforcing Bars in Each Reinforced Cell, 8 in CMU, Type S Mortar.
	B-6.	Properties of Wall Stiffeners With Two Reinforcing Bars in Each Reinforced Cell, 10 in CMU, Type S Mortar.
	B-7.	Properties of Wall Stiffeners With Two Reinforcing Bars in Each Reinforced Cell, 12 in CMU, Type S Mortar.
	B-8.	Properties of Wall Stiffeners With One Reinforcing Bar in Each Reinforced Cell, 6 in CMU, Type N Mortar.
	B-9.	Properties of Wall Stiffeners With One Reinforcing Bar in Each Reinforced Cell, 8 in CMU, Type N Mortar.
	B-10.	Properties of Wall Stiffeners With One Reinforcing Bar in Each Reinforced Cell, 10 in CMU, Type N Mortar.
	B-11.	Properties of Wall Stiffeners With One Reinforcing Bar in Each Reinforced Cell, 12 in CMU, Type N Mortar.
	B-12.	Properties of Wall Stiffeners With Two Reinforcing Bars in Each Reinforced Cell, 8 in CMU, Type N Mortar.
	B-13.	Properties of Wall Stiffeners With Two Reinforcing Bars in Each Reinforced Cell, 10 in CMU, Type N Mortar.
	B-14.	Properties of Wall Stiffeners With Two Reinforcing Bars in Each Reinforced Cell, 12 in CMU, Type N Mortar.
	B-15.	Reinforcement Spacing in Inches for 6 Inch CMU Wall With One Reinforcing Bar in Each Reinforced Cell.
	B-16.	Reinforcement Spacing in Inches for 6 Inch CMU Wall With One Reinforcing Bar in Each Reinforced Cell.
	B-17.	Reinforcement Spacing in Inches for 6 Inch CMU Wall With One Reinforcing Bar in Each Reinforced Cell.
	B-18.	Reinforcement Spacing in Inches for 6 Inch CMU Wall With One Reinforcing Bar in Each Reinforced Cell.
	B-19.	Reinforcement Spacing in Inches for 6 Inch CMU Wall With One Reinforcing Bar in Each Reinforced Cell.
	B-20.	Reinforcement Spacing in Inches for 6 Inch CMU Wall With One Reinforcing Bar in Each Reinforced Cell.
	B-21.	Reinforcement Spacing in Inches for 6 Inch CMU Wall With One Reinforcing Bar in Each Reinforced Cell.
	B-22.	Reinforcement Spacing in Inches for 6 Inch CMU Wall With One Reinforcing Bar in Each Reinforced Cell.
	B-23.	Reinforcement Spacing in Inches for 6 Inch CMU Wall With One Reinforcing Bar in Each Reinforced Cell.
	B-24.	Reinforcement Spacing in Inches for 6 Inch CMU Wall With One Reinforcing Bar in Each Reinforced Cell.
	B-25.	Reinforcement Spacing in Inches for 8 Inch CMU Wall With One Reinforcing Bar in Each Reinforced Cell.
	B-26.	Reinforcement Spacing in Inches for 8 Inch CMU Wall With One Reinforcing Bar in Each Reinforced Cell.
	B-27.	Reinforcement Spacing in Inches for 8 Inch CMU Wall With One Reinforcing Bar in Each Reinforced Cell.
	B-28.	Reinforcement Spacing in Inches for 8 Inch CMU Wall With One Reinforcing Bar in Each Reinforced Cell.

LIST OF TABLES (Cont'd)

Table	B-29.	Reinforcement Spacing in Inches for 8 Inch CMU Wall With One Reinforcing Bar in Each Reinforced Cell.
	B-30.	Reinforcement Spacing in Inches for 8 Inch CMU Wall With One Reinforcing Bar in Each Reinforced Cell.
	B-31.	Reinforcement Spacing in Inches for 8 Inch CMU Wall With One Reinforcing Bar in Each Reinforced Cell.
	B-32.	Reinforcement Spacing in Inches for 8 Inch CMU Wall With One Reinforcing Bar in Each Reinforced Cell.
	B-33.	Reinforcement Spacing in Inches for 8 Inch CMU Wall With One Reinforcing Bar in Each Reinforced Cell.
	B-34.	Reinforcement Spacing in Inches for 8 Inch CMU Wall With One Reinforcing Bar in Each Reinforced Cell.
	B-35.	Reinforcement Spacing in Inches for 8 Inch CMU Wall With One Reinforcing Bar in Each Reinforced Cell.
	B-36.	Reinforcement Spacing in Inches for 8 Inch CMU Wall With One Reinforcing Bar in Each Reinforced Cell.
	B-37.	Reinforcement Spacing in Inches for 8 Inch CMU Wall With One Reinforcing Bar in Each Reinforced Cell.
	B-38.	Reinforcement Spacing in Inches for 12 Inch CMU Wall With One Reinforcing Bar in Each Reinforced Cell.
	B-39.	Reinforcement Spacing in Inches for 12 Inch CMU Wall With One Reinforcing Bar in Each Reinforced Cell.
	B-40.	Reinforcement Spacing in Inches for 12 Inch CMU Wall With One Reinforcing Bar in Each Reinforced Cell.
	B-41.	Reinforcement Spacing in Inches for 12 Inch CMU Wall With One Reinforcing Bar in Each Reinforced Cell.
	B-42.	Reinforcement Spacing in Inches for 12 Inch CMU Wall With One Reinforcing Bar in Each Reinforced Cell.
	B-43.	Reinforcement Spacing in Inches for 12 Inch CMU Wall With One Reinforcing Bar in Each Reinforced Cell.
	B-44.	Reinforcement Spacing in Inches for 12 Inch CMU Wall With One Reinforcing Bar in Each Reinforced Cell.
	B-45.	Reinforcement Spacing in Inches for 12 Inch CMU Wall With One Reinforcing Bar in Each Reinforced Cell.
	B-46.	Reinforcement Spacing in Inches for 12 Inch CMU Wall With One Reinforcing Bar in Each Reinforced Cell.
	B-47.	Reinforcement Spacing in Inches for 12 Inch CMU Wall With One Reinforcing Bar in Each Reinforced Cell.
	B-48.	Reinforcement Spacing in Inches for 12 Inch CMU Wall With One Reinforcing Bar in Each Reinforced Cell.
	B-49.	Reinforcement Spacing in Inches for 12 Inch CMU Wall With One Reinforcing Bar in Each Reinforced Cell.
	B-50.	Reinforcement Spacing in Inches for 12 Inch CMU Wall With One Reinforcing Bar in Each Reinforced Cell.
	C-1.	6" CMU Lintel 8" Deep—1 Bar Type S Mortar.
	C-2.	6" CMU Lintel 16" Deep—1 Bar Type S Mortar.
	C-3.	6" CMU Lintel 24" Deep—1 Bar Type S Mortar.
	C-4.	6" CMU Lintel 32" Deep—1 Bar Type S Mortar.
	C-5.	6" CMU Lintel 40" Deep—1 Bar Type S Mortar.
	C-6.	6" CMU Lintel 48" Deep—1 Bar Type S Mortar.
	C-7.	8" CMU Lintel 8" Deep—2 Bar Type S Mortar.
	C-8.	5" CMU Lintel 16" Deep—2 Bar Type S Mortar.
	C-9.	8" CMU Lintel 24" Deep—2 Bar Type S Mortar.
	C-10.	8" CMU Lintel 32" Deep—2 Bar Type S Mortar.
	C-11.	8" CMU Lintel 40" Deep—2 Bar Type S Mortar.
	C-12.	8" CMU Lintel 48" Deep—2 Bar Type S Mortar.
	C-13.	10" CMU Lintel 8" Deep—2 Bar Type S Mortar.
	C-14.	10" CMU Lintel 16" Deep—2 Bar Type S Mortar.
	C-15.	10" CMU Lintel 24" Deep—2 Bar Type S Mortar.
	C-16.	10" CMU Lintel 32" Deep—2 Bar Type S Mortar.
	C-17.	10" CMU Lintel 40" Deep—2 Bar Type S Mortar.
	C-18.	10" CMU Lintel 48" Deep—2 Bar Type S Mortar.
	C-19.	12" CMU Lintel 8" Deep—2 Bar Type S Mortar.
	C-20.	12" CMU Lintel 16" Deep—2 Bar Type S Mortar.
	C-21.	12" CMU Lintel 24" Deep—2 Bar Type S Mortar.
	C-22.	12" CMU Lintel 32" Deep—2 Bar Type S Mortar.
	C-23.	12" CMU Lintel 40" Deep—2 Bar Type S Mortar.
	C-24.	12" CMU Lintel 48" Deep—2 Bar Type S Mortar.
	C-25.	6" CMU Lintel 8" Deep—1 Bar Type N Mortar.
	C-26.	6" CMU Lintel 16" Deep—1 Bar Type N Mortar.
	C-27.	6" CMU Lintel 24" Deep—1 Bar Type N Mortar.
	C-28.	6" CMU Lintel 32" Deep—1 Bar Type N Mortar.
	C-29.	6" CMU Lintel 40" Deep—1 Bar Type N Mortar.
	C-30.	6" CMU Lintel 48" Deep—1 Bar Type N Mortar.
	C-31.	8" CMU Lintel 8" Deep—2 Bar Type N Mortar.
	C-32.	8" CMU Lintel 16" Deep—2 Bar Type N Mortar.
	C-33.	8" CMU Lintel 24" Deep—2 Bar Type N Mortar.
	C-34.	5" CMU Lintel 32" Deep—2 Bar Type N Mortar.
	C-35.	8" CMU Lintel 40" Deep—2 Bar Type N Mortar.
	C-36.	8" CMU Lintel 48" Deep—2 Bar Type N Mortar.
	C-37.	10" CMU Lintel 8" Deep—2 Bar Type N Mortar.
	C-38.	10" CMU Lintel 16" Deep—2 Bar Type N Mortar.
	C-39.	10" CMU Lintel 24" Deep—2 Bar Type N Mortar.
	C-40.	10" CMU Lintel 32" Deep—2 Bar Type N Mortar.
	C-41.	10" CMU Lintel 40" Deep—2 Bar Type N Mortar.
	C-42.	10" CMU Lintel 48" Deep—2 Bar Type N Mortar.
	C-43.	12" CMU Lintel 8" Deep—2 Bar Type N Mortar.
	C-44.	12" CMU Lintel 16" Deep—2 Bar Type N Mortar.

LIST OF TABLES (Cont'd)

Table	C-45.	12" CMU Lintel 24" Deep—2 Bar Type N Mortar.
	C-46.	12" CMU Lintel 32" Deep—2 Bar Type N Mortar.
	C-47.	12" CMU Lintel 40" Deep—2 Bar Type N Mortar.
	C-48.	12" CMU Lintel 48" Deep—2 Bar Type N Mortar.

CANCELLED

CHAPTER 1

INTRODUCTION

1-1. Purpose. This manual prescribes criteria and furnishes guidance for the structural design of reinforced masonry in buildings.

1-2. Scope. The requirements for reinforced masonry in this manual will be used for the design of masonry elements of buildings to be constructed in all seismic zones. In addition to the requirements in this manual, masonry buildings constructed in seismic zones 1 through 4, will be designed in accordance with TM 5-809-10/NAVFAC P-355/AFM 88-3, Chapter 13. In areas of conflict, the reinforcing and detailing requirements of TM 5-809-10/NAVFAC P-355/AFM 88-3, Chapter 13 supersedes the requirements in this manual. The requirements contained herein are limited to buildings not more than nine stories of 120 feet in height. For masonry design requirements for taller buildings, CEMP-ET will be consulted. In overseas construction, where local materials of grades other than those specified herein are used, the design methods, details and other requirements of this

manual will be modified as applicable. Unreinforced masonry construction is permitted only for nonstructural partitions in seismic zone 0. For these partitions, the unreinforced masonry design criteria given in ACI 530 will be used, however, the minimum reinforcement around openings given herein must be satisfied. When evaluating existing reinforced masonry in buildings in seismic zone 0, this manual will be used. When evaluating existing unreinforced masonry in buildings in seismic zone 0, ACI 530 will be used. All new masonry buildings will be designed as reinforced masonry in accordance with the requirements of this manual. Applicable building codes, and exceptions thereto, are noted herein. The structural design is based on the working stress method. Tables, figures and design examples are presented as design aids for convenience in the design of brick and concrete masonry buildings.

1-3. References. Appendix A contains a list of references used in this manual.

CHAPTER 2

QUALITY ASSURANCE IN MASONRY

2-1. Introduction. This chapter provides guidance for quality assurance in masonry. Quality assurance in masonry starts with the design engineer's preparation of the plans and specifications. These documents must contain adequate information for the contractor to construct a quality masonry product. In addition, the field quality assurance staff must have the support of engineering during the construction period to assure that the design intent is being accomplished. The design engineer must recognize that engineering support is required on a continual basis from the onset of the design through the completion of construction. Masonry is a field-assembled product that requires exacting construction control in order to ensure satisfactory performance. To achieve a high quality product, all participants in the design/construction process must know their role and must communicate their needs to the other participants. To this end; guidance is provided herein for contract drawings, shop drawings, instructions to the field, and site visits.

2-2. Design/construction process overview. The design process begins with communication among the members of the design team, including the architect, and the structural, mechanical and electrical engineers, to plan the layout of the masonry features of the building. Careful planning to achieve modular dimensions in masonry walls, both the total wall dimensions and the sizes and locations of openings (including the location and sizing of large openings for ducts and utilities), to eliminate excessive masonry unit cutting is a very important step in the process. The concept of modular coordination in masonry is an attempt to increase productivity and reduce costs in construction by adoption of coordinated masonry units and masonry panel sizes which are as standardized as is practical. A 4-inch module has been widely accepted by producers of building materials. However, for reinforced concrete masonry unit (CMU) walls, establishing an 8-inch module will eliminate or greatly reduce the field cutting of masonry units and will allow a standardized 8-inch pattern of reinforcing placement. Thus, for convenience and economy, an 8-inch module should be used in structural CMU walls and wythes whenever possible. Once the layout is developed, the contract plans must show sufficient details to adequately communicate to the contractor and the field quality

assurance staff the intent of the designer. When detailing of the masonry is not completed on the contract drawings, it is very important to complete this detailing process on the shop (detail) drawings, which then become extensions of design. To achieve an understanding among all participants in the process and to provide the contractor and the quality assurance staff all needed information, it is most important that the shop drawings be approved prior to commencing masonry construction. Although all material and execution items in the contract documents are important, it is most helpful to the field quality assurance staff that the designer indicate those few items which can be termed "critical" to the achievement of the intent of the design. This can best be done with "Instructions to the Field", which are not a part of, but which supplement the construction contract documents. The last major item in the design/construction process, and the item most often missing from the process, is the designer visits to the field during periods critical to masonry construction. These visits can be an educational experience for both the designer and field personnel. Aside from the obvious benefit of direct communication on site, it has been shown that site visits can open a line of communication between field and office personnel. This develops the necessary contacts for effective communication should problems arise during construction.

2-3. Role of design engineers. The major items in the design engineer's role in the design/construction process are the following:

a. Approaches to masonry design/detailing. The designers will use the masonry details that have been developed for Corps-wide application as the basis for development of contract documents. These masonry details will be modified and supplemented as needed to fit the project requirements. Several approaches concerning the level of completeness of contract drawing detailing can be used by designers.

(1) One approach is to show typical details, tables of reinforcement, and other minimal information on the contract drawings. This approach requires that the masonry detailing be completed on the shop (detail) drawings, thus the shop drawings become a very important and critical extension of design. It is therefore very important that the structural design engineer not only provide a very

careful and complete review of the masonry details provided on the shop drawings-but must also make certain that the shop drawing details are coordinated with all architectural and mechanical needs. Of particular concerns is assurance that mechanical openings which penetrate structural masonry walls are included. With this detailing approach, constructing masonry walls without approved shop drawings can lead to numerous construction problems.

(2) Another detailing approach is to provide greater amounts of masonry detailing, including numerous section cuts and typical wall elevations. This is an intermediate approach that would still require a very careful review of the shop drawings by the designer; since, as described above, the shop drawings would still be a very important extension of design.

(3) On the opposite extreme to the first approach above, the structural designer may provide essentially every masonry detail; including all masonry wall elevations with every rebar, every masonry unit, and all masonry openings including every mechanical opening; on the contract drawings. Although showing every detail of every structural and nonstructural masonry wall and partition is clearly excessive, the more complete the development of details of the contract drawings, the higher the assurance that shop drawings are done correctly and thus the more expedient the approval should be.

b. Minimum contract drawing details requirements. The extent of detailing needed on the contract drawings is different for every building. The level of development of masonry contract drawings versus reliance on shop drawing details is a matter of efficiency and must be based on the judgement of the design office. In most situations, providing masonry wall elevations which show all wall openings, including ducts and piping, provides the greatest assurance for eliminating conflicts during construction. Whatever detailing approach is used, complete designs that give a clear understanding of the most critical features of construction is imperative to assure a quality constructed product. In all cases, the shop drawings must be approved by a structural engineer. Although the level of masonry detailing needed is different for every building, there are minimum contract drawing details that are required for all masonry construction. Therefore, the contract drawings for all masonry construction should contain minimum masonry details as follows —

(1) Typical details for piers, columns and pilasters and their location. It must be clear how the typical details are to be applied to all required locations for these elements.

(2) Concrete masonry unit control joint (CJ) and brick expansion joint (BEJ) details. Both plan and elevation views are normally needed to clearly locate and dimension, throughout the structure, all CJ's and BEJ's.

(3) Details of horizontal and sloping tops of walls. Include control joints, beam pocket openings and method of anchorage for the roof system as applicable.

(4) Typical details of reinforcement around openings. It must be clear how the typical details are to be applied at all openings.

(5) Details showing continuity of structural bond beams. Particular attention must be given to achieving continuity in stepped structural bond beams at the tops of sloping walls. Sloping continuous bond beams have a higher assurance of satisfactory performance.

(6) Details showing intermediate bond beams and how continuity is provided when it is interrupted by openings and corners.

(7) Details of mechanical openings that may have a significant structural impact.

c. Instructions to the field. Often, the best way to provide the field quality assurance personnel the information they need to identify the critical masonry construction features, details, etc.; which must be present to carry out the intent of the designer; is with instructions to the field. Masonry construction includes a wide variety of materials including brick, CMU, mortar, grout, flashing, reinforcing steel, joint reinforcement, CJ keys, BEJ materials, anchor bolts, etc.; all of which are assembled by a mason to form walls, columns, piers, and pilasters. Although any or all of these items may be contained in the contract documents for a masonry building, and thus all are important, the quality assurance program does not allow for continuous observation by Corps field personnel. Instructions to the field, which identify those items that are most critical to constructing quality masonry, will allow the field quality assurance personnel to maximize the limited inspection time available. The following items, which represent areas that have caused significant problems on a repetitive basis, are not all inclusive, however, should be identified as critical items in all "Instructions to the Field" lists:

(1) *Mortar proportions* must be in accordance with the contract. Strength, resistance to water permeance, protection of reinforcement and durability are derived by the proper mixture.

(2) *Grout slump* must be in the range specified, usually 8-10 inches, and must be mechanically vibrated as specified to assure complete filling of cells. Mortar or concrete must not be used in lieu of grout.

(3) *Reinforcing steel* must be properly positioned and held in place for grouting and mechanical vibration. Lap lengths must be as required by the contract drawings. Unapproved interruptions of reinforcing steel for openings must not be allowed. The structural engineer should be contacted when conflicts arise.

(4) *Air spaces* in anchored veneer walls must be kept free of excessive mortar droppings. This will allow water that passes through the outer masonry wythe to proceed downward in the air space to reach the flashing and exit through the weepholes.

(5) *Brick expansion joints*, both vertical and horizontal, must be kept free of all material, including mortar, and then sealed with backer rods and sealant. Compressible material that is installed in the expansion joint for the purpose of keeping mortar out of the joint, etc., should not be used.

(6) *Masonry bonding* at the corners is required. This detail is needed to provide adequate lateral support to corners of walls during and after construction.

(7) *Joint reinforcement* must be the type specified, usually the ladder type, and must be properly placed. One longitudinal wire will be installed in each mortar bed. This normally requires two longitudinal wires per concrete masonry unit (CMU) wythe and one longitudinal wire per brick wythe. Truss type joint reinforcement should not be used. Factory fabricated intersections and corners are required. Longitudinal wires should be properly located within mortar beds to provide needed corrosion protection.

(8) *Insulation* panels used in cavity wall construction must be in close contact at all panel edges and must be tightly adhered to the backup wythe to achieve the assumed U-value.

(9) *Flashing* must be installed so that cells to be grouted are not blocked. Thus, flashing that is identified as "thru-wall" should not extend further into the masonry backup wythe than the first mortar bed. Joints in flashing must be lapped and sealed. Properly sealed joints are especially critical in wall systems with steel stud backup. Partial panel length flashing for lintels, etc., should be turned up to form dams at the ends.

(10) *Ceramic glazed and prefaced masonry units* should be set level and true so that the glazed and prefaced facing will present true planes and surfaces free of offsets or other distortions.

(11) *Masonry unit protection*. Tops of masonry that are exposed to rain or snow, while being stored and in partially constructed walls, must be covered with nonstaining waterproof covering or membrane when work is not in progress. Covering must extend a minimum of 2 feet down on each side and be held securely in place. The covering should allow air movement so that the masonry can reach ambient moisture equilibrium.

(12) *Other items critical to the specific project* should also be included, such as, prism testing of high strength masonry, etc.

d. Site visits. The final step in the design/construction process to achieve quality masonry construction is site visits by the designer. The purposes of these visits by the designer are:

(1) To see that the design intent is being reflected in the construction.

(2) To facilitate discussion between the construction field office personnel and the designer on special features of the design and critical construction items.

(3) To provide feedback on construction problem areas and to develop design improvements.

(4) To open the lines of communication between the designer and field personnel so that problems and concerns will be more freely discussed. Although it is recognized that the degree of engineering support during construction is under continual time and cost constraints, the need and value of site visits by the designer has been clearly established in published guidance. Every effort to implement a program of site visits during critical phases of masonry construction should be made. The designer should not make field visits only in response to field problems. Note that the "Instructions to the Field" given above provide an excellent short checklist both for the field quality assurance staff and for the designer during routine field visits to masonry construction.

CHAPTER 3

MATERIALS, PROPERTIES, STANDARD TESTS AND EFFLORESCENCE

3-1. Introduction. This chapter is an overview of the nature, properties and standard tests of the materials which are used for masonry construction. The material presented in this chapter is primarily concerned with the properties of clay and concrete masonry units which affect structural design. A discussion of the causes, methods of prevention and methods of cleaning of efflorescence is also included.

3-2. Clay masonry units.

a. Ingredients. Clay masonry units primarily consists of clay, shale or similar naturally occurring earthy substances, water and additives. Most clays are composed mainly of silica and alumina of extremely small particle size formed by decomposition of rocks.

b. Manufacturing processes. The majority of the solid and hollow clay masonry units currently used in the U.S. are produced by the "stiff-mud" process, also known as the "wire-cut" process. The basic components of the process are-preparation of the clay or clays; mixing with water, and additives if any; extrusion through a die as a continuous ribbon; cutting the clay ribbon into discrete units using steel wire; and controlled firing in which the units are heated to the early stage of incipient vitrification. Vitrification occurs when a material changes to a glassy substance by heat and fusion. Peak temperatures attained during the firing

sequence are in the 2000-degree Fahrenheit range. Solid clay units, as defined below, may also be manufactured by molding processes, for example, the soft mud and dry press. Subsequent to molding, the units are dried and fired as in the wire-cut process.

c. Size and shape. Clay masonry units are available in a wide variety of shapes, sizes and coring patterns, several of which are illustrated in figure 3-1. Figures 3-1a through 3-1e represent clay units defined as solid, that is, the net area is 75 percent or more of the gross area. Figure 3-1f illustrates a hollow unit. The width, W, of solid clay units normally ranges from 3 inches to 4 inches, the height, H, from 2¼ inches to 4 inches and the length, L, from 7⅝ inches to 11⅝ inches, although larger units have been produced. Hollow clay units whose net area is less than 75 percent of the gross area, as shown in figures 3-1f have been produced in a relatively small number of sizes and core configurations. The shape shown has a length equal to 11⅝ inches and a height equal to 3⅝ inches. Widths of 3⅝ inches, 5⅝ inches and 7⅝ inches are also available.

d. Visual properties. The color of clay masonry units by the chemical composition, surface treatment, burning intensity, and methods of burning control. These factors also affect the strength of units. The choice of color for aesthetic purposes

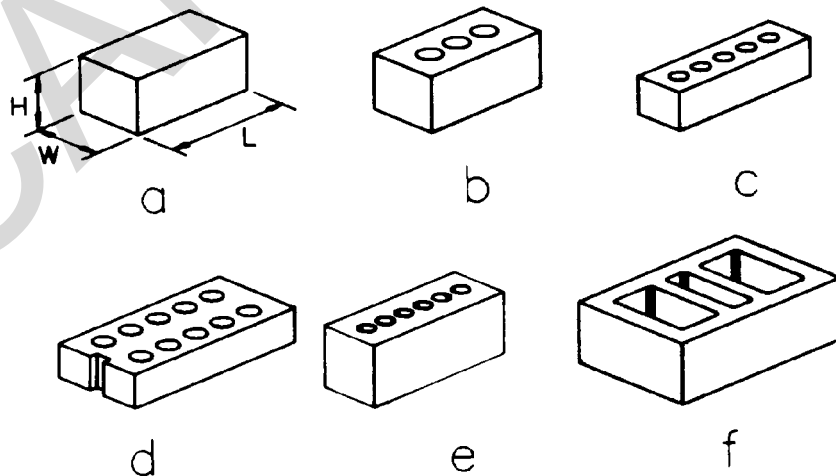

U. S. ARMY CORPS OF ENGINEERS

Figure 3-1. Typical Clay Masonry Units.

thus may influence structural performance. Various types of surface texturing, which is formed by steel wire cutting parallel to the direction of extrusion, may be created on the face surfaces of clay units. Surface texture is a factor influencing bond strength between the clay units and the mortar or grout.

e. Material properties. Material properties of clay masonry units which can affect their structural performance include: durability, initial rate of absorption, compressive strength, flexural strength, and expansion potential.

(1) *Durability.* Durability primarily refers to the ability of a masonry unit to withstand environmental conditions, such as freeze-thaw action. Clay masonry units have been classified in ASTM C 62, C 216, and C 652 according to their weather resistant capacities into the following grades: Severe Weathering, SW; Moderate Weathering, MW; and No Weathering, NW. Durability, or weather resistance classification, is evaluated in terms of compressive strength and water absorption as presented in table 3-1.

Table 3-1. Durability¹

Designation	Minimum Comprehensive Strength (Brick Flatwise) Psi Gross Area		Maximum ² Water Absorption by 5 hour Boiling percent		Maximum ³ Saturation Coefficient	
	Average of 5 Bricks	Individual	Average of 5 Bricks	Individual	Average of 5 Bricks	Individual
SW	3000	2500	17.0	20.0	0.78	0.80
MW	2500	2200	22.0	25.0	0.88	0.90
NW ⁴	1500	1250	No Limit	No Limit	No Limit	No Limit

¹Summarized from ASTM C 62, C 216 and C 652

²Initially immersed for 24 hours in cold water. Five hour absorption equals the amount of water absorbed after immersion in boiling water for five hours expressed as a percentage of the weight of the dry unit.

³Saturation coefficient is the ratio of absorption after 24 hours in cold water to the absorption after 5 hours in boiling water.

⁴Applies only to a class of masonry units covered by ASTM C 62.

(2) *initial rate of absorption.* Clay masonry units have a tendency to draw water from mortar or grout with which they are in contact due to a capillary mechanism caused by small pores in the units. This phenomenon is termed the initial rate of absorption, IRA, or suction and has been linked to structural characteristics of masonry such as the bond between mortar and the unit. The quality of bond between mortar and masonry unit is a function of properties of each. However, for many often used mortar mixes an IRA value in the 10-25 grams per 30 square inches per minute range has been observed to be most desirable. Absorption test procedures can be found in ASTM C 67.

(3) *Compressive strength.* Compressive strength of clay masonry units is measured by loading specimens to failure in a direction consistent with the direction of service loading in accordance ASTM C 67. Compressive strength of units provides a basis for assuming the compressive strength of the masonry assemblage.

(4) *Flexural strength.* Flexural strength, or modulus of rupture, determined in accordance with ASTM C 67, is basically a measure of the tensile strength of a masonry unit. It is somewhat correlated to unit compressive strength.

(5) *Expansion potential.* Clay masonry units immediately after manufacture are extremely dry and expand due to absorption of moisture from the atmosphere. The magnitude of the initial expansion depends on the characteristics of the unit materials,

the firing temperature and the ambient moisture conditions. The initial expansion is irreversible. Additional, but small, amounts of contraction or expansion due to temporary variations in masonry moisture content may occur. Clay unit masonry is also subject to expansion and contraction due to temperature variations.

3-3. Concrete masonry units. Concrete masonry units are made from lightweight or normal weight aggregates, or both, to obtain three classes of masonry units; normal weight, medium weight, and lightweight. The structural requirements of ASTM C 90 are the same for all classes. Normal weight units are generally used where lightweight aggregate is not readily available and the cost of obtaining the lightweight aggregate does not offset the advantages of lightweight units. The advantages of lightweight units include ease of handling and hauling, increased productivity, reduced dead loads, improved resistance to thermal flow, improved absorption of transmitted sound, and higher fire resistance. One disadvantage of lightweight units is that they are more porous. This makes them more difficult to paint or seal as required for interior and exterior exposure.

a. Ingredients. Concrete masonry units primarily consist of portland cement or blended cement, aggregate and water. Hydrated lime and/or pozzolans as well as air entraining agents may be used. Other ingredients that have been established as

suitable for use in concrete such as coloring pigments, ground silica, etc., may also be used.

b. Manufacturing process. Concrete masonry units are cast using no slump concrete. The mixture is placed into molds and vibrated under pressure for a specified time to obtain compaction. Higher strength units can be obtained by subjecting the material to longer vibration and compaction periods. The units are removed from the molds and may be cured under normal atmospheric conditions, or by autoclaving (steam curing).

c. Size and shape. Concrete masonry units are available in a wide variety of sizes and shapes as shown in figure 3-2. They may be classified as hollow or solid.

(1) A solid unit is defined in ASTM C 90 as having a net area not less than 75 percent of the gross area. A type of unit known as concrete building brick, ASTM C 55, is available which is completely solid. Solid units are typically $7\frac{5}{8}$ inches high and are available in several lengths and widths. Concrete bricks are normally $3\frac{5}{8}$ inches wide, $2\frac{1}{4}$ inches high and $7\frac{5}{8}$ inches or $15\frac{5}{8}$ inches long.

(2) A hollow unit is defined in ASTM C 90 as having face shell and web thicknesses which conform to the requirements listed in Table 2 of the C 90 standard. Most hollow concrete masonry units range from 50 to 70 percent of the gross area, depending on such factors as: unit width, wall (face shell and web) thickness, and core shape. Hollow

units are typically $15\frac{5}{8}$ inches long; either $7\frac{5}{8}$ inches or $3\frac{5}{8}$ inches high; and $7\frac{5}{8}$ inches, $5\frac{5}{8}$ inches, or $3\frac{5}{8}$ inches wide. Nominal widths up to 16 inches are also available in many areas. The walls of most hollow concrete units taper or are flared and thicker on one bed surface of the unit than the other to enable release from the mold during production. Hence, the net concrete cross-sectional area may be greater on the top of the unit than the bottom. For structural reasons, ASTM C 90 stipulates minimum wall thickness for load-bearing concrete masonry units.

d. Visual properties. Color other than the normal concrete gray may be obtained for concrete units by adding pigments into the mix at the time of manufacture or by painting after installation. A variety of surface effects are possible including smooth face, rough (split) face, and fluted, ribbed, recessed, angular and curved faces, some of which may affect cross-sectional area calculations.

e. Classifications. Concrete masonry units are classified according to moisture content requirements. The two types of moisture controlled units are:

(1) Type I, Moisture-Controlled Units, which must conform to the appropriate ASTM moisture content requirements.

(2) Type II, Nonmoisture-Controlled Units, which have no moisture control requirements.

f. Material properties. The material properties

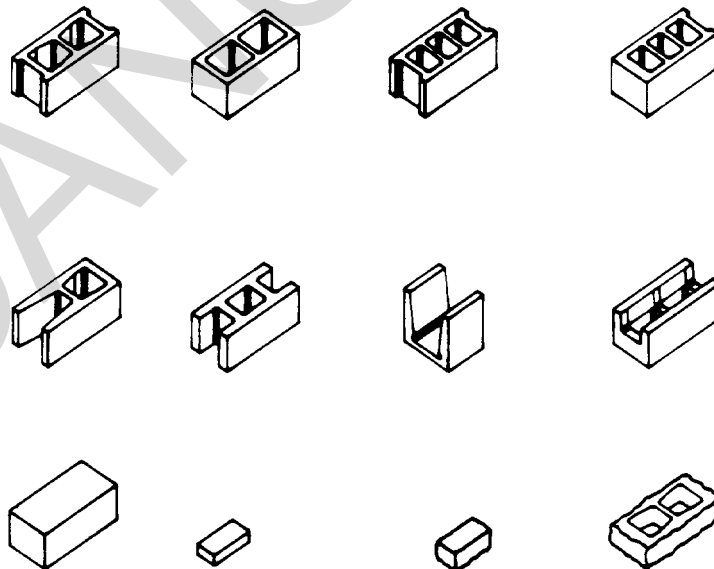

U. S. ARMY CORPS OF ENGINEERS

Figure 3-2. Examples of concrete masonry units.

of concrete units which can affect the structural performance of installed masonry include: absorption; moisture content; shrinkage potential; temperature expansion/contraction; compressive strength; and flexural strength.

(1) *Absorption.* Absorption of a concrete masonry unit, determined in accordance with ASTM C 140 is the total amount of water, expressed in pounds per cubic foot, that a dry unit will absorb and is somewhat related to density.

(2) *Moisture content.* Moisture content is expressed as a percent of the total water absorption possible for a given concrete masonry unit. Dimensional changes of concrete masonry due to changes in unit moisture content can have serious effects upon the structure depending upon the nature of the boundary conditions and size of a given masonry element. The most common effect is shrinkage cracking due to a loss of moisture. Moisture loss is affected by the humidity of the air surrounding a particular masonry element. Moisture conditions, and thus cracking potential, may be significantly different for interior and exterior elements.

(3) *Shrinkage potential.* Shrinkage potential characteristics of a given unit, determined according to ASTM C 426, depend upon the method of manufacture and the materials. The linear shrinkage potential values given in the appropriate ASTM's represent an attempt to equalize drying shrinkage for units of different shrinkage potential considering differences in humidity conditions.

(4) *Temperature expansion/contraction.* As is the case for most materials, concrete masonry expands and contracts with temperature changes.

(5) *Compressive strength.* The compressive strength of concrete masonry units is established in accordance with ASTM C 140. This test is a measure of unit quality. The compressive strength of the masonry units, along with the mortar strength, provide the basis for assuming the compressive strength of the masonry assemblage. Factors which affect compressive strength include: water-cement ratio, degree of compaction, and cement content. Minimum compressive strength requirements are presented in the appropriate ASTM's for the various kinds of units.

(6) *Flexural strength.* Flexural strength, modulus of rupture, is basically a measure of the tensile strength of a masonry unit and is somewhat correlated to the unit compressive strength.

3-4. Mortar. Mortar, ASTM C 270, is a mixture of cementitious materials, aggregate and water. Mortar serves to bond masonry units together to form a composite structural material. As such, mortar is a factor in the compressive, sheer, and

flexural strengths of the masonry assemblage. In addition, mortar compensates for dimensional and surface variations of masonry units, resists water and air penetration through masonry, and bonds to metal ties, anchors, and joint reinforcement so that they perform integrally with the masonry units.

a. Cementitious materials. Cementitious materials used are portland cement, ASTM C 150; or portland blast furnace cement, ASTM C 595; and lime, ASTM C 207; or masonry cement, ASTM C 91. Masonry cement has limited applications. Mortar made with portland cement, lime, aggregate (sand) and water is preferred since all constituents are well defined. While both types of mortar have similar attributes and requirements, the discussion herein applies specifically to mortar made with portland cement, lime, and aggregate. In general, it may not be possible to specify a mortar, which will be optimal for both workability and strength. A mortar which is workable with the masonry units being used under site environmental conditions will usually result in a masonry assemblage with acceptable strength and good quality joints.

b. Aggregate (sand). Well-graded sand, ASTM C 144, with a uniform distribution of particle sizes is necessary to produce a workable mortar which is dense and strong in the hardened state. Sand on the finer side of the permitted gradation range will produce a more workable mortar than a mortar made with coarser sand. However, the mortar with finer sand requires more water to be workable and is therefore weaker. The particles of manufactured sand are sharp and singular and tend to produce a less workable mortar than that made with natural sand of rounded particles. More water may be required to obtain adequate workability of mortar made with manufactured sand than that made with natural sand, resulting in a lower strength due to the higher water-cement ratio.

c. Mortar proportions. According to ASTM C 270, mortar may be specified either in terms of proportions (by volume of portland cement, hydrated lime, and aggregate) or in terms of properties (required compressive strength). The proportion method is the only method allowed by the guide specification. It should be noted that mortar conforming to the proportion specifications of ASTM C 270 may have compressive strength far in excess of the minimum values prescribed for the property method.

d. Mortar types. The four types of mortar given in ASTM C 270 are; in order of descending strength; M, 5, N, and 0. Generally as strength increases, workability decreases. Since a good mortar must have a combination of strength and workability, the mortars on the extremes (M and 0)

should not be used. Although S and N are allowed in the guide specifications, Type S exhibits the best overall qualities of strength and workability and normally should be specified.

e. Water retentivity. Mortar exposed to air tends to lose water by evaporation. Mortar in contact with masonry units tends to lose water to the units because of the suction of the units. Retentivity is the mortar property associated with resistance to such water loss and resultant loss of workability. Lime in mortar improves the water retentivity and workability. Ideally, retentivity of a mortar should be compatible with the suction of the units used and environmental conditions, such as, temperature and humidity, so that adequate workability is maintained. Water content of mortar should be as high as possible consistent with proper workability and suction of the masonry units to maximize bond of the mortar to units. Water retentivity is measured by methods described in ASTM C 91. Units with high suction require the use of mortar with high retentivity to prevent excess and rapid water loss and reduced workability. It is noted in ASTM C 67, in the case of clay-unit masonry, that mortar which has stiffened due to water loss because of suction results in poor bond and water permeable joints. It is suggested in ASTM C 67 that clay masonry units with initial rates of absorption in excess of 30 grams per minute per 30 square inches be wetted prior to placing to reduce suction. If wetting is done, care should be taken to ensure uniformity.

f. Flow. Flow determined by methods of ASTM C 109 is a rough measurement of workability, but is not a test amenable to construction sites. No generally accepted procedure has been developed for field measurement of workability; the mason is the best judge.

g. Factors affecting mortar compressive strength. Mortar compressive strength, typically measured by uniaxial compression of 2 inch cubes in accordance with ASTM C 109 is a measure of relative mortar quality. Because of several factors, such as, state of stress, water content, and dimensions, the compressive strength of a mortar cube is not directly related to compressive strength of mortar in a masonry joint. The basic factors which affect uniaxial cube compressive strength, however, are essentially those which affect mortar performance in masonry, such as, proportions of portland cement, hydrated lime and sand, water content, admixtures, air content, mixing time, and sand characteristics. The proportions are critical factors affecting cube compressive strength. The variation in mortar cube strength due to mix proportions is illustrated in figure 3-3. The circled

values for sand and lime illustrates a typical Type S mix of 1 part cement, ½ part lime and 4½ parts sand. The figure indicates that the expected cube strength is approximately 3700 pounds per square inch, using these proportions. The band between the two sloping straight lines reflects the range of proportions as prescribed in ASTM C 270.

h. Factors affecting mortar to unit bond. Because mortar not only seals masonry against wind and water penetration, but also binds masonry units together, strength and bond of mortar are essential to well-constructed masonry. Two forms of bond strength are important for structural purposes, tensile bond strength and shear bond strength. Tensile bond is required to resist forces perpendicular to a mortar-unit joint while sheer bond is required to resist forces parallel to such joints. The factors which affect bond are basically common to both with the exception of the influence of compression on shear bond. Factors affecting bond strength include:

(1) *Mortar properties.*

(a) *Cement content.* Other factors equal, greatest bond strength is associated with high cement content.

(b) *Retentivity.* Bond strength is enhanced if high retentivity mortar is used with high-suction units and low absorption.

(c) *Flow.* Bond is enhanced by using the maximum water content consistent with good workability considering unit properties and environmental conditions.

(d) *Air content.* Bond decreases with increasing air content.

(2) *Masonry unit properties.*

(a) *Surface texture.* Mortar flows into voids, cracks, and fissures and forms a mechanical attachment to the surface of the unit.

(b) *Suction.* For a given mortar, bond strength decreases as unit suction increases. This is perhaps due to the rapid loss of water to the unit on which mortar is placed. The mortar becomes less workable and bond becomes less reliable.

(3) *Workmanship factors.*

(a) *Time.* The time lapse between spreading mortar on a unit and placing a unit upon that mortar should be minimized to reduce the effects of water loss from mortar due to suction of the unit on which it is placed.

(b) *Movement.* Movement of units after placing can reduce, if not break, bond between mortar and unit.

(c) *Pressure and tapping.* Units must be placed on mortar with sufficient downward pres-

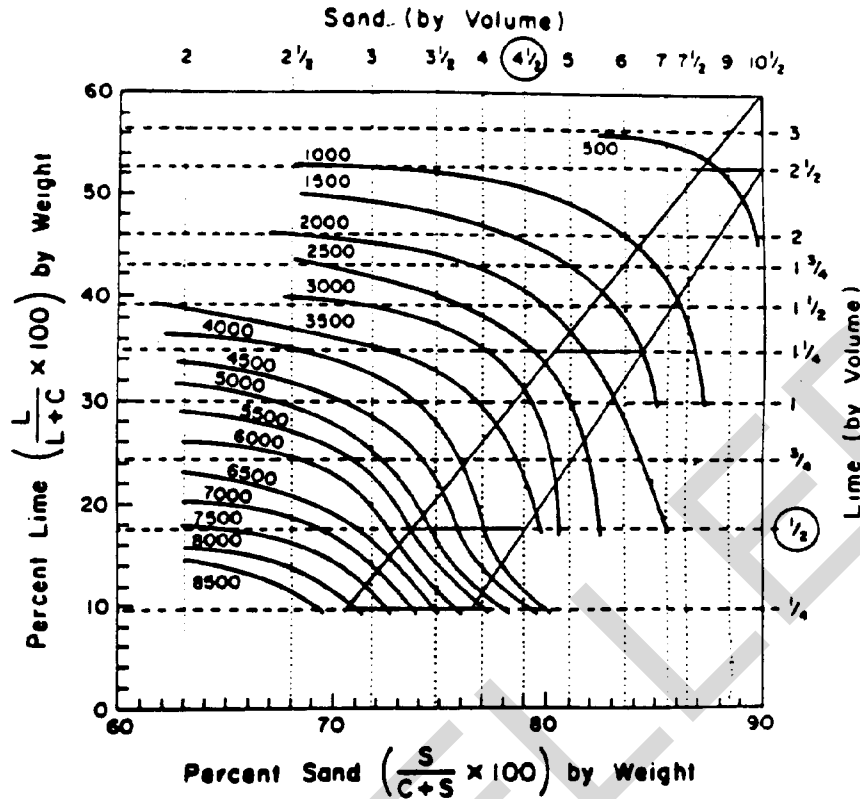

Courtesy of the University of Colorado at Boulder, noncopyrighted.

Figure 3-3. Strength of mortar (psi) versus constituent proportions.

sure, possibly augmented by tapping, to force the mortar into intimate contact with the unit surface.

i. *Construction factors effecting mortar.* Proper mixing is essential to obtain a uniform distribution of materials and the desired workability and strength properties. Retempering, that is, adding water to mortar to restore workability as permitted by ASTM C 270 should be employed with extreme caution because the water-cement ratio may be altered with attendant loss of strength.

3-5. Grout. Grout, ASTM C 476, is a mixture of cementitious materials and aggregate to which sufficient water has been added to permit the grout to be readily poured into masonry grout spaces without segregation of the materials. Grout is placed in the cavities formed by the masonry units. It bonds to the masonry units and to steel reinforcement, ties, and anchors to form a unified composite structure.

a. *Grout type and materials.* Grout is identified as fine or coarse depending on the maximum size of the aggregate used. Fine or coarse grout should be used in accordance with the guide specification.

b. *Grout strength.* Grout will have a minimum compressive strength of 2000 pounds per square inch as measured by a uniaxial compressive test in

accordance with ASTM C 1019.

c. *Requirements during construction.* Masonry units and grout interact in the same manner as unit-mortar interaction, that is, water is drawn from the grout into the masonry by suction. The final grout strength is a function of water content after suction.

(1) *Mixing grout.* Because of better control, grout should be batched and mixed in transit-mix trucks.

(2) *Placing grout.* Grout may be poured or pumped into grout spaces. Proper placement of grout requires that it be sufficiently fluid to be pourable and to completely fill the grout space. The suction of the masonry units, IRA, in the case of clay masonry units, will influence the amount of water required in grout. Higher water content is required if masonry units have a high rate of absorption (suction) to reduce the tendency of grout to adhere to the sides of the grout space while it is being poured and thus constrict the space. The converse is true if the units have low suction. A grouting admixture may be useful in retarding water loss from grout. The water content may be lower for large grout spaces (4-inch least dimension), than for small grout spaces (2-inch or smaller least dimension). Slump, as measured by

the standard 12 inch truncated cone test, is typically from 8 inches to 10 inches, depending upon the fluidity required.

(3) *Consolidating grout.* Consolidation is essential to obtaining grout in-place without voids or debonding due to shrinkage. Poor consolidation may cause reduced masonry compressive strength and poor bond of grout to masonry unit. Mechanical vibration is greatly superior to puddling and should be used for consolidating all grout pours greater than one masonry course in height. Consolidation should be done by vibrating soon after grout placement and by re-vibrating when the excess water has been absorbed from the grout by the masonry units. Mechanical vibration must be done before the grout has stiffened to prevent a void in the grout caused by the vibrator.

3-6. Reinforcement. Masonry is reinforced with steel bars or joint reinforcement. Joint reinforcement, placed in mortar beds, is unique to masonry and is primarily used to resist internal forces due to shrinkage or thermally-induced movement.

3-7. Standard tests.

a. Compression. The compressive strengths of masonry assemblages may be established by testing small masonry assemblages referred to as “prisms”, in accordance with ASTM E 447. To establish the compressive strength of a given unit-mortar assemblage, a minimum of three prisms must be tested. Prisms may be constructed in stack-bond or in a bonding arrangement which simulates the bonding pattern to be used in the structure, except no structural reinforcement is used in the prisms. Masonry prisms should be constructed with the same materials, joint thickness, and workmanship used in the structure.

b. Shear. In reinforced masonry, shear loads may be carried either by the masonry or, if the masonry is not adequate, by the reinforcing steel. Masonry is an assemblage of discrete units and mortar, so when the shear force is carried by the masonry, two forms of shear strength exist. These strengths are diagonal tension strength and sliding shear strength along the mortar joint. The standard tests used to determine the shear strength in masonry are as follows:

(1) *Diagonal tension tests.*

(a) The standard diagonal tension test; presented in ASTM E 519, Diagonal Tension (Shear) in Masonry Assemblages; establishes the diagonal tension of masonry panels by loading 4-foot by 4-foot panels in compression along one diagonal. Failure occurs in tension perpendicular to the diagonal. The value of the compression load, P, at failure is converted to an equivalent shear stress,

S_s , by:

$$S_s = \frac{0.707P}{A} \quad (\text{eq 3-1})$$

Where:

A = The average of the gross areas (solid-unit masonry) or net areas (hollow unit masonry) of the two contiguous upper sides of the specimen.

(b) The racking test described in ASTM E 72 (Section 14) has been used to measure diagonal tensile strength of eight foot by eight foot wall specimens. However, hold-down forces induced by the test fixture complicate the state of stress.

(2) *Sliding shear strength.* The sliding shear strength is the strength in bond between the mortar and the units which resists relative movement of adjacent units in a direction parallel to the mortar joint between them. In case of shear walls, where shear is normally considered to be a horizontal force parallel to the bed joints, sufficient bond between mortar and units must exist in order for diagonal tension strength to be developed. Otherwise failure occurs in step-wise fashion along a diagonal in the plane of the wall. It has been shown experimentally that joint shear strength is increased by compression across the joint. Results obtained by testing small specimens under controlled conditions reflect a friction coefficient of approximately 1.0.

c. Flexure test. The standard test to establish flexural strength in masonry is given in ASTM E 518, which provides requirements for materials, specimen preparation and configuration, testing, and calculations. The test establishes flexural tensile bond strength in a direction perpendicular to the bed joint by third-point or uniform loading of stack-bond specimens. Extreme care is required in handling flexural bond test specimens. Flexural tensile bond strength may also be determined by the “bond wrench” test. The test is based upon “prying off” one masonry unit at a time from a multi-unit stack-bond prism (or beam). Flexural tensile stress is calculated based upon an assumption of a linear flexural stress distribution across the unit width. Equations provided in ASTM C 1072 account for the effects of compression due to the load and its eccentricity. The test apparatus is detailed in the standard. Whereas flexural beam tests provide one data point, that is the beams fail at one joint, the bond wrench method provides as many data points as there are joints in the specimens.

(1) The flexural capacity of unreinforced masonry walls depends either upon the tensile bond between units, as shown in figure 3-4a, or upon the

shear-bond of overlapping units depending on the direction of flexure and type of construction as depicted in figure 3-4b. Flexure which induces shear-bond stresses between overlapping units may be limited by shear bond strength or by flexural tensile unit strength.

(2) The flexural capacity of reinforced masonry is essentially limited by masonry compressive strength or by tensile strength of the reinforcement. Compression reinforcement can add to flexural strength in beams, particularly if it is confined. Vertical reinforcement in shear walls is used to provide tensile strength for in-plane and out-of-plane reversible moment. Failure of slender shear walls in in-plane flexure is characterized by progressive damage to the masonry at the compression face followed by buckling of the unconfined vertical reinforcement. Confinement of vertical reinforcement in shear walls retards progressive damage and increases ductility.

(3) Tests of prisms and short walls under eccentric compression indicate that at failure the maximum compressive stress, due to combined bending and compression, calculated on the assumption of linear elastic behavior, exceeds ultimate uniaxial compressive stress, by a factor on the order of 4/3.

d. Modulus of elasticity. The modulus of elasticity of masonry, E_m , may be obtained by instrumenting compression specimens, prisms, in accordance with ASTM E 111. Experimental evidence indicates that moduli obtained from tests of flat-end prisms corresponds well to moduli of full-scale walls. Although the true stress-strain relationship of masonry is non-linear (basically a parabolic curve), in many applications it is possible that dead load stress is sufficient to achieve the initial stiffening represented by the lower portion of the curve of figure 3-5, thus justifying use of the inner portion which is often approximately linear. The design methods in this manual assumes E_m is linear and is

assumed to change linearly with the compressive strength of masonry, P_m , as follows:

$$E_m = 1000 f'_m < 3\,000,000 \text{ psi} \quad (\text{eq 3-2})$$

3-8. Efflorescence. Efflorescence is a fine, white, powdery deposit of water-soluble salts on the surface of masonry or in the pores of masonry. The most common salts are sulfate and carbonate compounds of sodium, potassium, calcium, magnesium and aluminum, although others exist.

a. Effect. The primary effect or objection is the appearance of efflorescence on the surface of masonry, both clay and concrete. It can be a serious visual defect. However, under certain conditions, salts deposited below the surface of a masonry unit can cause cracking and spalling due to forces generated by salt crystallization. This can further degrade appearance, but has the more serious effect of reduced structural properties.

b. Source. The main source of salts is the portland cement used in mortar and grout. Other sources can include the masonry units, sand used in mortar and grout, and the water. Hydrated lime used in mortar does not generally contribute to efflorescence.

c. Cause. Water-soluble salts are brought to the surface of masonry in solutions of water and deposited there by evaporation. The salts solution may migrate across the surfaces of the units or through the pore structure of the masonry units. Therefore, the conditions which lead to efflorescence are:

- (1) A source of soluble salts must be present.
- (2) A source of water to dissolve the salts must be available.
- (3) The water must be in contact with the salts for a sufficient time to dissolve them and carry the solution to the masonry unit surface and into the pores of the units.

d. Control. Because the salts must be in solution

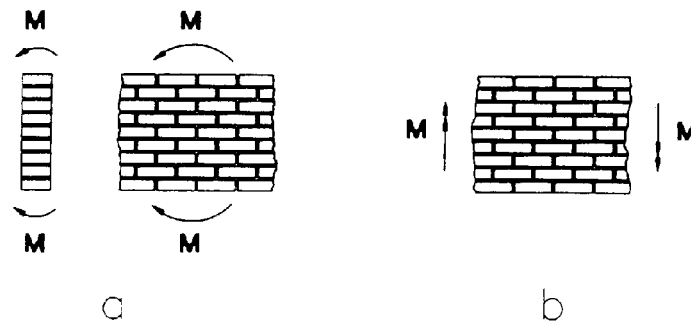

U. S. ARMY CORPS OF ENGINEERS

Figure 3-4. Masonry wall flexure.

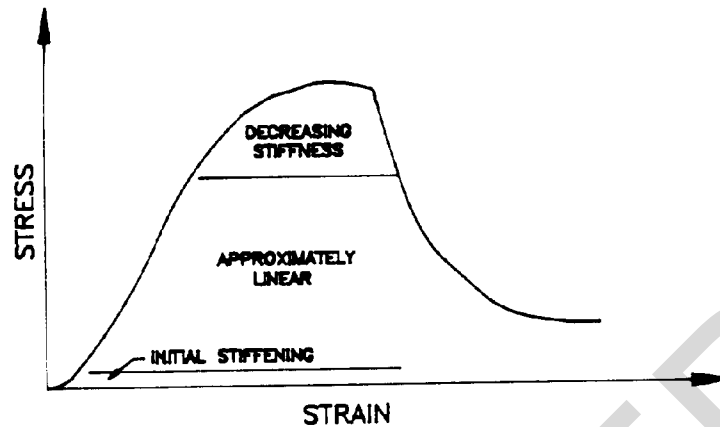

J. S. ARMY CORPS OF ENGINEERS

Figure 3-5. Masonry stress-strain curve.

to cause efflorescence, the obvious solution is to prevent the intrusion of water. This is difficult during construction because of the water present in mortar and grout. During construction, partially completed masonry elements and all on site masonry materials should be protected to minimize water intrusion from rain, snow or other sources.

e. Design Details. The most critical item in preventing efflorescence is providing good masonry details that will prevent water penetration into the completed masonry construction. The design and details of the structure, of which the masonry components are a part, should be such that water exposure and penetration of the masonry will be minimal. Overhanging eaves, capping of walls, copings, sealants, flashing, and tooling of mortar joints are examples. Equally important is the maintenance of these features.

f. Cleaning. Efflorescence occurring during or just after construction may disappear with normal weathering. If not, the following cleaning methods may be done in ascending order-doing the least necessary to achieve the desired result.

(1) Dry brushing may remove most efflorescence.

(2) In warm, dry weather washing may be used, but it should be realized that washing requires the use of water which may bring more salts to the surface.

(3) Chemical cleaners are available such as a 1:12 muriatic acid solution. Use requires presoaking to limit the depth of penetration of the solution and thorough washing afterwards to remove all traces of the solution.

(4) Sandblasting has been used but is not recommended because of its damaging effect on mortar and unit surfaces.

CHAPTER 4

DESIGN FOR CRACK CONTROL

4-1. Introduction. This chapter provides criteria and methods to control cracking in concrete and brick masonry walls, composite walls, and anchored veneer wythes. Normally, cracking in masonry results from shrinkage in concrete masonry unit construction and expansion in brick masonry unit construction. Uncontrolled cracking is a significant problem in the masonry industry. Cracking is controlled by proper placement of joints, proper material selection, and by steel reinforcement, or a combination thereof. Although the cracking of masonry is not normally a structural design consideration, the locations of joints placed in masonry walls to control cracking can affect the structural performance of the wall. The crack control criteria contained herein is based on locations where environmental changes (temperature and moisture fluctuations) are large. When supported by successful local practice; the designer may deviate from the joint locations, material selections, and reinforcement criteria contained in this manual. Locations and details of control joints, bond beams, brick expansion joints, and structural expansion joints will be shown on the contract drawings on both plan and elevation views.

4-2. Concrete masonry walls. Cracking of concrete masonry walls is generally caused by shrinkage due to moisture loss in the units. Methods used to control cracking in concrete masonry structures are materials specifications to limit the drying shrinkage potential, control joints (CJ's) to accommodate movement, and reinforcement to control crack size and location.

a. Material specifications. The type of unit to be used in all construction will be ASTM C 90, moisture controlled, type I, units. Type II units, which have no moisture control, will not be used. The ASTM C 90 standard provides limits on moisture content for moisture controlled units depending on linear shrinkage potential and average annual relative humidity at the place where the units will be installed. For example, in an area where the average annual relative humidity is 50 to 75 percent and the linear shrinkage potential of the unit is 0.03 percent, the units should be delivered to the site with a maximum moisture content of 40 percent. Units with a linear shrinkage potential of 0.045 to 0.065 percent, delivered to the same site, should have a maximum moisture content of 30 percent. The purpose of this part of the standard is

to limit the shrinkage of the unit in the wall to a level sufficient to control cracking. Masonry units delivered and stored at the site should be protected from rain and snow, which would increase their moisture content.

b. Control joints. To control shrinkage cracking, control joints should be placed and spaced to divide walls or wythes into a series of rectangular panels. Control joints should also be placed in areas of high stress concentration where cracking is most likely to occur. Normal spacing and desirable locations for control joints are noted in table 4-1. Control joints should not be located at openings due to construction and performance problems and minimum reinforcement requirements. For structural walls, the minimum reinforcement around openings is given in chapter 5. For non-structural partitions, the minimum reinforcement around openings will consist of one No. 4 bar at each side and at the top and bottom of each opening. Reinforcing bars will extend 24 inches beyond the edge of the opening.

Table 4-1. Recommended control joint spacing ^(a)

VERTICAL SPACING OF JOINT REINFORCEMENT WITH 2-#9 WIRES ^(b) (IN)	MAXIMUM RATIO OF PANEL LENGTH TO WALL HEIGHT (L/H) ^(c)	MAXIMUM SPACING OF CON- TROL JOINTS ^(d) (FT)
None ^(e)	2	18
16	3	24
8	4	30

^(a)based on moisture-controlled, type I, concrete masonry in intermediate humidity conditions (ASTM C 90). The designer should adjust the control joint spacing for local conditions. The recommended spacing may be increased 6 feet in humid climates and decreased 6 feet in arid climates.

^(b)Joint reinforcement will be cold-drawn deformed wire with a minimum 9 gauge longitudinal wire size.

^(c)L is the horizontal distance between control joints. H is generally the vertical distance between structural supports.

^(d)The spacing will be reduced approximately 50% near masonry bonded corners or other similar conditions where one end of the masonry panel is restrained.

^(e)Not recommended for walls exposed to view where control of cracking is important.

Recommended control joint locations

- a. At regular intervals as noted in table above.
- b. At changes in wall height or thickness. (This does not include at pilasters.)
- c. Near wall intersections in "L", "T", and "U" shaped buildings at approximately 50% of the spacing required above.
- d. At other points of stress concentration.

e. At control joints in foundation walls and in floors that support masonry walls.

(1) A keyway or interlock will be provided across control joints as a means of transferring lateral shear loads perpendicular to the plane of the wall. Transfer of bending moments or diagonal tension across control joint keyways or interlocks should not be assumed. Control joints should be weathertight.

(2) Control joints in concrete masonry unit walls will be continuous and vertical. Control joint details must provide an uninterrupted weak plane for the full height of the wall, including intermediate bond beams and masonry foundation walls. However, reinforcing steel in structural bond beams must be continuous through control joints. Control joints need not extend into reinforced concrete foundation walls.

(3) Control joints divide walls into panels which are separate structural elements. Hence, locations of control joints effect the relative rigidity of wall panels and, in turn, the distribution of lateral (seismic or wind) forces and the resulting unit stresses. Therefore, adding, eliminating or relocating control joints, where the lateral load resisting system is sensitive to control joint location, will not be permitted once the structural design is complete.

(4) The control joint location criteria above applies to all walls exposed to view where control of cracking is important. For walls not exposed to view, a control joint spacing of four times the diaphragm to diaphragm height or 100 feet, whichever is less, may be used.

c. *Joint Reinforcement.* Joint reinforcement distributes local temperature and shrinkage stresses and allows a greater control joint spacing to be used. Joint reinforcement spacing as it relates to control joint spacing is provided in table 4-1. It is recommended that all walls exposed to view, where control of cracking is important, have joint reinforcement spaced not more than 16 inches on center. Joint reinforcement will be terminated at control joints.

d. *Control joint detailing.* Control joints are either flush, raked, or raked and sealed depending on specific requirements as given in the guide specifications.

4-3. Brick walls. Cracking in brick masonry generally results from a combination of expansion due to moisture absorption by the brick and thermal expansion of the brick wall. Detailing of brick masonry must allow for both horizontal and vertical expansion of the wall or wythe panels. Crack control in brick walls is accomplished with brick

expansion joints (BEJ's). The allowance for expansion and the criteria to establish joint spacing given herein may be adjusted when climatic conditions warrant.

a. *Brick expansion.* The total unrestrained expansion of clay brick masonry walls, W_x , may be estimated from the following formula:

$$W_x = [\epsilon_A + \epsilon_T(\Delta T)](L) \tag{eq 4-1}$$

$$= [0.0003 + 0.000004(\Delta T)](L)$$

Where:

ϵ_A = The coefficient for volume change due to moisture expansion. It will be assumed equal to 0.0003 times the wall length.

ϵ_T = The thermal coefficient of expansion for clay or shale brick. It will be assumed equal to 0.000004 per unit length per degree Fahrenheit.

ΔT = The maximum temperature differential expected during the life of the structure, degrees Fahrenheit. ΔT should not be assumed less than 100.

L = The length of wall between expansion joints, inches.

b. *Vertical expansion joints.* Crack control for horizontal expansion in brick is mainly accomplished by the proper placement of continuous vertical BEJ's. BEJ's should be placed and spaced to divide a wall into a series of rectangular panels to control cracking. Since the backer rod and sealant used for sealing vertical BEJ's are assumed to be only 50% compressible, the computed total expansion value, W_x , must be multiplied by two to obtain the required joint width. The maximum vertical BEJ spacing for various expansion joint widths, based on $\Delta T = 100^\circ F$, along with desired joint locations of vertical BEJ's are listed in table 4-2. BEJ's in parapet walls will be at one half the spacing of the supporting walls below. Vertical BEJ's do not transfer bending moment or shear and must occur at locations where no load transfer is required.

Table 4-2. Maximum spacing of vertical expansion joints in brick walls, $\Delta T = 100^\circ F$

EXP. JT. WIDTH (IN)	W_x (IN)	MAX. SPACING OF BEJ's ^(a) (FT)
3/8	3/16	22
1/2	1/4	30
3/4	3/8	44
1 (MAX)	1/2	60

^(a)Provide expansion joints at 6 to 10 feet from corners.

Recommended vertical BEJ locations

- a. At regular intervals as noted in table above.
- b. At changes in wall height or thickness.
- c. Near wall intersections in "L", "T", and "U" shaped buildings at approximately six to ten feet from corners.
- d. At other points of stress concentration.
- e. At edges of openings.

c. *Horizontal expansion joints.* Crack control

for vertical movement in brick walls is accomplished with horizontal BEJ's. The minimum horizontal joint width will be $\frac{3}{8}$ inch. This minimum joint width will accommodate movement for most buildings in normal situations. Designers should be aware of building effects, such as, elastic shortening and creep. These effects may require a greater joint width. Recommended horizontal BEJ joint locations are:

- (1) Under shelf angles and lintels which are supported by back up wythes.
- (2) At each floor level to multi-story buildings.
- (3) At points of stress concentration due to vertical movement restraint.

d.. Reinforcement. BEJ locations and spacing are not adjusted when joint reinforcement is used. However, joint reinforcement is recommended as it will provide greater resistance to cracking due to environmental conditions.

e. Joint detailing. Expansion joints are sealed with backer rod and mortar colored sealant. Joints as small as $\frac{3}{8}$ inch may be used if architectural considerations dictate. The joints must be kept clear of all material other than the backer rod and sealant. Foam rubber fillers are not permitted in brick expansion joints.

4-4. Anchored veneers. Anchored brick and concrete masonry unit veneers must be isolated on three sides from the back-up wythe. Since the veneer is isolated from the back-up wythe, concrete masonry unit control joints or brick expansion joints in the veneer need not align with the joints in the back-up wythe.

a. Brick masonry anchored veneer. Joint spacing and locations and other requirements are as described in paragraph 4-3 and table 4-2.

b. Concrete masonry anchored veneer. It is recommended that all concrete masonry anchored veneer contain joint reinforcement at not more than 16 inches on center. Control joint spacing and locations will be according to paragraph 4-2 and table 4-1, except that control joints at openings

should be similar to brick veneer. Control joint details will be similar to brick veneer, i.e., both vertical and horizontal joints will normally be $\frac{1}{2}$ -inch wide and closure will be with a backer rod and sealant.

4-5. Composite walls. Where both wythes of the composite wall are concrete masonry, the designer will apply the prescribed crack control procedures for concrete masonry to each wythe. Where brick and concrete masonry units are used together in composite type walls, control joints and expansion joints must extend through the full thickness of the wall wherever either one is required. Brick expansion joints also serve the requirements of control joints but control joints do not serve as expansion joints.

4-6. Isolation of nonstructural partitions. When a masonry wall is not a part of the lateral or vertical load resisting system it will be isolated. Isolation joints will be provided between the partition and the frame, structural walls, or roof, etc., to prevent loading the partition.

4-7. Shelf angles. Masonry walls and veneers in multistory buildings or in buildings with a large number of openings are often supported on shelf angles at intervals of one or two story levels. The shelf angle will be secured against rotation and against deflections over $\frac{1}{16}$ -inch. A $\frac{1}{2}$ -inch space between the ends of shelf angles will be provided to allow for thermal expansion. Shelf angles will be mitered and made continuous at the corners of the building.

4-8. Other than running bond masonry. In addition to the requirements in the previous paragraphs, all walls or wythes placed in other than running bond will have a minimum area of horizontal reinforcement. The minimum reinforcement will be 0.0007 times the vertical cross sectional area of the wall. Reinforcement may be placed in bed joints or in bond beams or both.

CHAPTER 5

GENERAL CRITERIA FOR REINFORCED MASONRY

5-1. Introduction. This chapter provides the general criteria for the design of reinforced masonry using the working stress design method. Generally, a running bond masonry pattern is the basis of the design and reinforcing requirements contained herein. Running bond is the strongest bond pattern and will be used unless a stacked bond pattern is essential to the architectural treatment of the building. Additional design and detailing requirements for stacked bond masonry are contained herein.

5-2. Working stress assumptions. The assumptions for the working stress design of reinforced masonry are the same as the assumptions used in the working stress design of reinforced concrete.

a. Basic assumptions. The basic assumptions are as follows:

- (1) Plane sections remain plane after bending.
- (2) Stress is proportional to strain which is proportional to the distance from the neutral axis.
- (3) The modulus of elasticity is constant throughout the member in the working load range.
- (4) Masonry does not resist tension forces.
- (5) Reinforcement is completely bonded so that the strain in the masonry and the strain in the reinforcement are the same at the location of the reinforcement.
- (6) External and internal moments and forces are in equilibrium.
- (7) The shearing forces are assumed uniformly distributed over the cross section.

b. Modular ratio. As per the basic assumptions above, the strain in masonry, ϵ_m , at a given load is equal to the strain in the reinforcing steel, ϵ_s , at the same location.

$$\epsilon_m = \frac{f_m}{E_m} = \epsilon_s = \frac{f_s}{E_s} \quad (\text{eq 5-1})$$

Where:

- f_m = The stress in the masonry, psi.
- f_s = The stress in the steel, psi.
- E_m = The modulus of elasticity of masonry, psi.
- E_s = The modulus of elasticity of steel, psi.

The modular ratio, n , is given by the following equation.

$$n = \frac{E_s}{E_m} \quad (\text{eq 5-2})$$

The relationship between f_s and f_m is then,

$$f_s = n(f_m) = \frac{E_s}{E_m}(f_m) \quad (\text{eq 5-3})$$

c. Transformed sections. When a masonry member is subjected to bending, the masonry above the neutral axis of the cross section is in compression. The masonry below the neutral axis is assumed cracked. The transformed section consists of the area of masonry above the neutral axis and n times the reinforcing steel area below the neutral axis. The transformed area of steel in tension, A_{trans} , is—

$$A_{\text{trans}} = (n)(A_s) \quad (\text{eq 5-4})$$

When the reinforcement and surrounding masonry is in compression, such as a column with a concentric axial load, A_{trans} is one of the following—

- (1) For long term loading conditions;

$$A_{\text{trans}} = (2n - 1)A_s \quad (\text{eq 5-5})$$

- (2) For other than long term loading conditions;

$$A_{\text{trans}} = (n - 1)A_s \quad (\text{eq 5-6})$$

Using $n-1$ or $2n - 1$, rather than n , accounts for the area of masonry in compression being occupied by the actual steel area.

5-3. Structural properties. The structural properties of hollow concrete masonry units provided in this manual are based on the minimum dimensions given in ASTM C 90. These properties may also be assumed for hollow brick masonry with the same minimum dimensions.

a. Unit types. It is recommended that open-end units, as shown in figure 5-1, be used in all masonry construction. The open-end unit shown in figure 5-1 meets the requirements of ASTM C 90. The use of

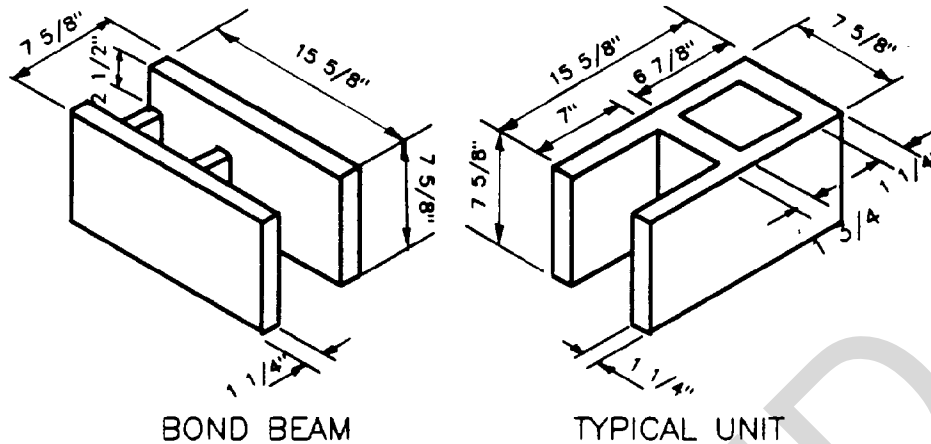

U. S. ARMY CORPS OF ENGINEERS

Figure 5-1. Open end unit 8 in X 8 in X 16 in.

open-end units allows placement of the vertical reinforcing steel with a minimum number of splices—thus vertical reinforcement can usually be continuous between supports. The vertical alignment of webs in open-end units provide large open cells that can be easily grouted. The grouted open-end cells provide good load transfer and allow for complete grouting of lintels and beams. Masonry units with three webs often have concave ends which makes it difficult to fully grout a wall. Therefore, when three web units are used in lintels, masonry beams, and fully grouted walls, grouting at each course level is required.

b. Section properties of reinforced masonry.

(1) Assumed concrete masonry unit dimensions. As a general rule, the dimensions for hollow CMU may be assumed as shown in figure 5-2 and given in table 5-1. These values will vary with unit type, geographic location, and manufacturer; however; they are considered conservative—thus were used in the design calculations in this manual.

Table 5-1. Assumed dimensions of hollow concrete masonry units and associated dimensions, inches.

CMU NOMINAL THICK.	CMU DESIGN THICK.	FACE SHELL THICK. (T_s)	WEB THICK. (t_w)	(d_1)	(d_2)	(b_w)
6	5 $\frac{5}{8}$	1	1	2.81	—	7 $\frac{1}{2}$
8	7 $\frac{5}{8}$	1 $\frac{1}{4}$	1	3.81	5.31	7 $\frac{1}{2}$
10	9 $\frac{5}{8}$	1 $\frac{3}{8}$	1 $\frac{1}{8}$	4.81	7.06	7 $\frac{1}{2}$
12	11 $\frac{5}{8}$	1 $\frac{1}{2}$	1 $\frac{1}{8}$	5.81	8.81	7 $\frac{1}{2}$

(2) Equivalent wall thickness. The equivalent thickness for masonry walls with hollow units and varying grouted cell spacings will be as shown in table 5-2.

Table 5-2. Equivalent wall thickness for computing compression and shear stress parallel to the wall for hollow concrete masonry units, inches.¹

SPACING OF GROUDED CELLS S, inches	NOMINAL WALL THICKNESS			
	6	8	10	12
Fully Grouted	5.62	7.62	9.62	11.62
16	3.70	4.90	5.98	7.04
24	3.13	4.10	4.91	5.70
32	2.85	3.70	4.37	5.02
40	2.68	3.46	4.05	4.62
48	2.57	3.30	3.83	4.35
56	2.49	3.19	3.67	4.16
64	2.42	3.10	3.56	4.01

Table 5-2. Equivalent wall thickness for computing compression and shear stress parallel to the wall for hollow concrete masonry units, inches.¹—Continued

SPACING OF GROUTED CELLS S, inches	NOMINAL WALL THICKNESS			
	6	8	10	12
72	2.38	3.03	3.47	3.90
No Grout	2.00	2.50	2.75	3.00

¹Based on face shells plus one 7½ inch wide web per “S” spacing. See figure 5-2a.

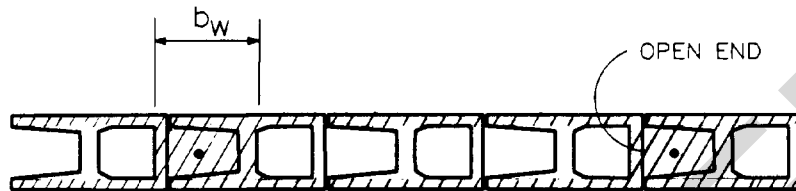

(a) Area Assumed Effective In Axial Compression and Area Assumed Effective In Shear Force Parallel to Face

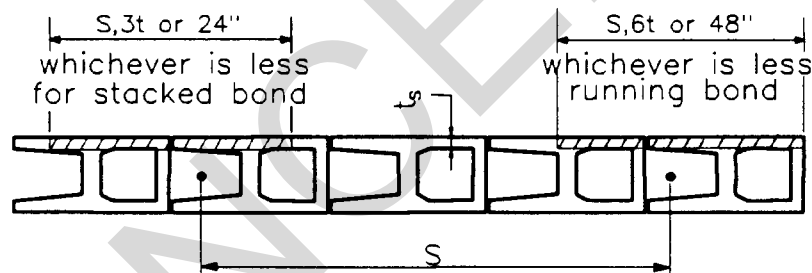

(b) Area Assumed Effective In Flexural Compression Force Normal to Face

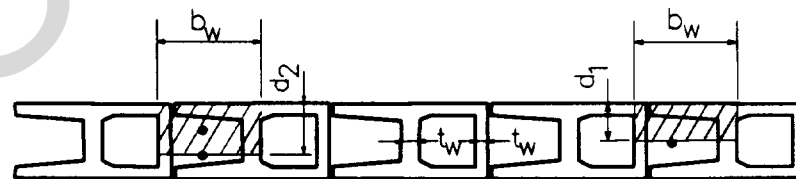

(c) Area Assumed Effective in Shear Force Normal to Face

U. S. ARMY CORPS OF ENGINEERS

Figure 5-2. Assumed dimensions and effective areas of hollow masonry.

TM 5-809-3/NAVFAC DM-2.9/AFM 88-3, Chap. 3

(3) *Effective area.* The effective area of hollow masonry used in design vary and are generally dependent upon the thickness of the face shells and the cross-webs, the width of grouted core, and the type of mortar bedding used in construction. Since contractors may use standard two-hole (plain or concave ends) or open-end concrete masonry units, and since exact configuration may vary between manufacturers, the precise effective area will be unknown at the time of design. The assumed effective areas for different loading conditions will be as illustrated in figure 5-2. Effective areas for masonry walls loaded in compression or in shear parallel to the wall are given in table 5-3. The effective area will be adjusted to reflect loss of area resulting from the use of reglets, flashing, slip-joints, and raked mortar joints.

Table 5-3. Area effective in axial compression and in in-plane shear, A_e' in²/ft.¹

SPACING OF GROUTED CELLS S, INCHES	NOMINAL WALL THICKNESS			
	6	8	10	12
Fully Grouted	68	92	116	140
16	44	59	72	85
24	38	49	59	68
32	34	44	52	60
40	32	42	48	55
48	31	40	46	52
56	30	38	44	50
64	29	37	43	48
72	28	36	42	47
No Grout	24	30	33	36

¹ Based on face shells plus one 7½ inch wide web per "S" spacing. See figure 5-2a.

(4) *Effective width of flexural compression block.* The effective width of the flexural compression stress block of reinforced masonry placed in both running and stacked bond patterns will be as illustrated in figure 5-2. The effective width will not exceed the spacing of the reinforcement, S.

(5) *Cracking moment and gross moment of inertia.* The cracking moment strength of a wall, M_{cr} , will be determined as follows:

$$M_{cr} = \frac{2I_g f_r}{t} (1b-in) \tag{eq 5-7}$$

Where:

f_r = the modulus of rupture for calculating deflection equal to $2.5\sqrt{f'_m}$, $2I_g/t$ is the section modulus, psi.

t = The actual thickness of the wall, inches.

I_g = The gross moment of inertia of the wall, in⁴.

The cracking moment strength along with the gross moment of inertia, I_g , are listed in table 5-4 for various wall thicknesses and reinforcing spacing.

Table 5-4. Gross moment of inertia and cracking moment strength for various widths of CMU walls¹. Type S mortar, $f'_m = 1350$ psi.

WIDTH b ² in	NOMINAL WALL THICKNESS							
	6		8		10		12	
	I_g in ⁴	M_{cr} ft-lb	I_g in ⁴	M_{cr} ft-lb	I_g in ⁴	M_{cr} ft-lb	I_g in ⁴	M_{cr} ft-lb
48	—	—	1319	2648	2470	3929	4119	5424
40	—	—	1113	2235	2092	3328	3499	4608
32	377	1027	907	1822	1714	2727	2879	3792
24	290	791	702	1409	1337	2126	2260	2976
16	204	554	496	995	959	1525	1640	2160
8	119	323	296	593	594	946	1047	1379

¹Based on face shells plus one 7½ inch wide web per "S" spacing. See figure 5-2a.

²"b" is assumed to be "S". It is limited to 6 times the nominal wall thickness, but not more than 48 inches. See figure 5-2b.

(6) *Design aids.* Section properties of reinforced masonry with type S and N mortars are given in appendix B, tables B-1 through B-14.

c. *Weight of masonry.* The design examples and tables included in this manual are based on normal-weight hollow masonry units. Normal-weight units are assumed to have an oven-dry weight of concrete of 145

pounds per cubic foot. Weights of lighter-weight units may be obtained by direct proportion to the lighter weight of concrete being used. Table 5-5 gives the weight of concrete masonry unit walls.

Table 5-5. Weight of CMU walls¹, w_2 , pounds per square foot.

SPACING OF GROUDED CELLS, S, inches	NOMINAL WALL THICKNESS			
	6	8	10	12
Fully Grouted	68	92	116	140
16	58	75	92	111
24	53	69	85	102
32	51	65	78	93
40	50	62	75	89
48	49	60	72	85
56	48	58	70	83
64	47	57	69	81
72	46	56	68	80
No Grout	43	50	59	69

¹Based on normal-weight units having a concrete weight of 145 pounds per cubic foot. An average amount has been added into those values to include the weight on bond beams and reinforcing.

Table 5-6 gives the average weights, gross and net areas of concrete masonry units.

Table 5-6. Gross areas, net areas and average weights of concrete masonry units¹.

THICKNESS (in)	GROSS AREA OF UNIT (in ²)	NET AREA OF UNIT (in ²)	LIGHT-WEIGHT AGGREGATE ² (lbs/unit)	SAND-GRAVEL AGGREGATE ² (lbs/unit)
4	57	37	15	20
6	88	50	23	33
8	119	57	28	38
12	182	83	40	56

¹The values given in this table are average values. Actual values will vary with type of unit and manufacturer. However, these table values will normally be sufficient for estimating purposes.

²Light-weight units are assumed to have a concrete weight of 105 pcf and sand-gravel units a concrete weight of 145 pcf.

5-4. Working stress design equations. The equations in this paragraph are the basic working stress equations used in the design of reinforced masonry.

a. *Flexural design rectangular sections.* The design assumptions, coefficients and cross section geometry used in the derivation of the flexural design equations for rectangular sections are illustrated in figure 5-3.

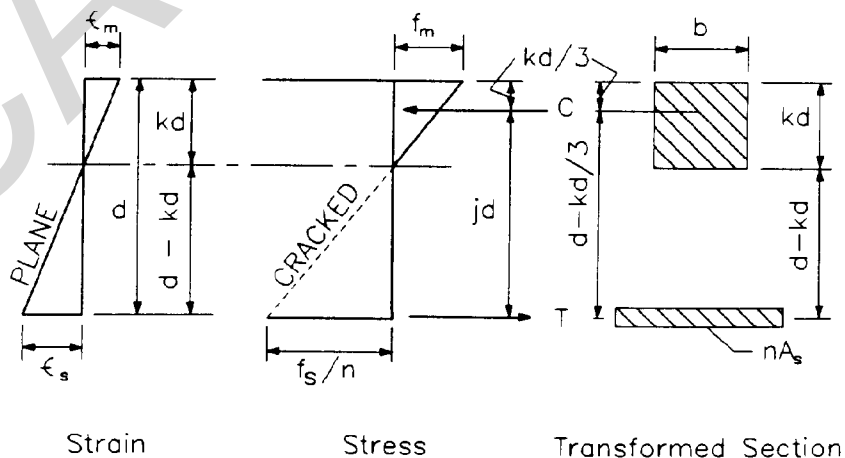

U. S. ARMY CORPS OF ENGINEERS

Figure 5-3. Working stress flexural design assumptions for rectangular sections.

TM 5-809-3/NAVFAC DM-2.9/AFM 88-3, Chap. 3

(1) *Design coefficients.* In the design of reinforced rectangular sections, the first step is to locate the neutral axis. This can be accomplished by determining the coefficient, k , which is the ratio of the depth of the compressive stress block to the total depth from the compression face to the reinforcing steel, d . k is derived by equating the moment of the transformed steel area about the centroidal axis of the cross section to the moment of the compression area about the centroidal axis as follows:

$$kd \left[\frac{b(kd)}{2} \right] = nA_s (d - kd)$$

Rearranging;

$$\frac{b(kd)^2}{2} - nA_s (d - kd) = 0$$

The steel ratio, p , is determined by:

$$p = A_s/bd$$

Substituting phd for A_s ;

$$\frac{b(kd)^2}{2} - npbd(d - kd) = 0$$

Dividing through by bd^2 ;

$$\frac{k^2}{2} - pn(1 - k) = 0$$

From which;

$$k = \left[(np^2 + 2np)^{1/2} - np \right] \quad (\text{eq 5-9})$$

The coefficient j , which is the ratio of the distance between the resultant compressive force and the centroid of the tensile force to the distance d , is determined by—

$$j = 1 - \frac{k}{3} \quad (\text{eq 5-10})$$

The balanced steel ratio in the working stress design method, p_e , is defined as the reinforcing ratio where the steel and the masonry reach their maximum allowable stresses for the same applied moment. p_e is determined by the equation 5-11 as follows:

$$p_e = \frac{n}{2(F_s/F_m) [n + F_s/F_m]} \quad (\text{eq 5-11})$$

Where:

F_s = The allowable tensile stress in the reinforcing steel, psi.

F_m = The allowable flexural compressive stress in the masonry, psi.

(2) *Computed working stresses.* The working stresses for the steel and the masonry are computed as follows:

(a) If $p < p_e$, the steel stress, f_s , will reach its allowable stress before the masonry and equation 5-12 will control.

$$f_s = \frac{M}{A_s j d} (\text{psi}) \quad (\text{eq 5-12})$$

(b) If $p > p_e$, the masonry stress, f_m , will reach its allowable stress before the steel and equation 5-13 will control.

$$f_m = \frac{2M}{k j b d^2} (\text{psi}) \quad (\text{eq 5-13})$$

Where:

M = The moment, inch-kips.

b = The width of the member effective in compression as shown in figure 5-2b, inches.

(3) *Resisting moments.*

(a) The resisting moment for the reinforcement, M_{rs} , can be determined by substituting the allowable steel stress, F_s , for the computed steel stress in equation 5-12 and solving for the moment.

$$M_{rs} = \frac{F_s A_s j d}{12} (\text{ft-lb}) \quad (\text{eq 5-14})$$

(b) The resisting moment for masonry, M_{rm} , can be determined by substituting the allowable masonry stress, F_m , for the computed masonry stress in equation 5-13 and solving for the moment.

$$M_{mm} = \frac{F_m k_j b d^2}{2(12)} (ft-lb) \quad (\text{eq 5-15})$$

b. *Flexural design T-sections.* The coefficients and cross section geometry used in the derivation of the flexural design equations for T-sections are illustrated in figure 5-4.

(1) *Design coefficients.* In the design of reinforced T-sections, as in the design of rectangular sections, the first step is to locate the neutral axis. As with rectangular sections, this can be accomplished by determining the coefficient k_T . k_T is derived by assuming that the compressive force in the flange, C , is equal to the tension force in the reinforcement. The contribution of the portion of the web in compression is small and can be neglected, therefore if;

$$T \approx C$$

Then,

$$p b d f_s = f_m \left[\frac{2k_T d - t_s}{2k_T d} \right] b t_s \quad (\text{eq 5-16})$$

Where:

t_s = The thickness of the face shell of the unit, inches.

From the strain compatibility relationship it can be determined that;

$$k_T = \frac{n}{n + (f_s/f_m)}$$

Rearranging the equation and solving for f_m yields:

$$f_m = (f_s) \frac{k_T}{n(1 - k_T)}$$

Substituting this equation for f_m into equation 5-16 yields;

$$k_T = \frac{np + 1/2(t_s/d)^2}{np + (t_s/d)} \quad (\text{eq 5-17})$$

The coefficient, j_T , can be determined by the relationship,

$$j_T d = d - z$$

Where:

z = The distance from the extreme compressive fiber to the center of compression (or the center of gravity of the trapezoid shown in figure 5-4) and is determined as follows:

$$z = \left[\frac{3k_T d - 2t_s}{2k_T d - t_s} \right] \left[\frac{t_s}{3} \right]$$

From the above equations j_T can be determined by:

$$j_T = \frac{6 - 6(t_s/d) + 2(t_s/d)^2 + (t_s/d)^3[1/(2pn)]}{6 - 3(t_s/d)} \quad (\text{eq 5-18})$$

The resisting moments of the steel and masonry are equal to the product of the moment arm, $j_T d$, and the tension or compression force, respectively, therefore:

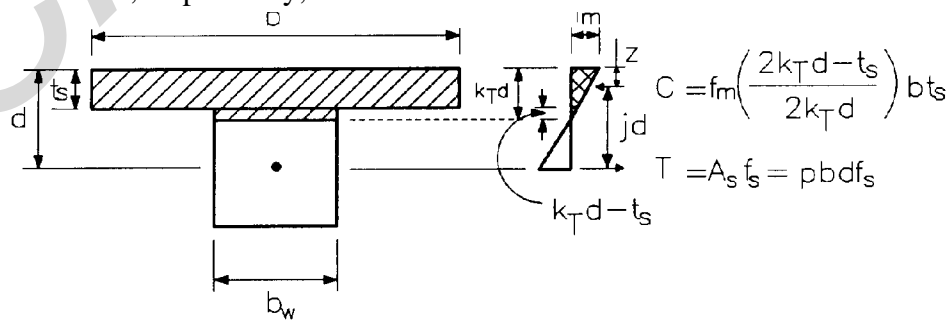

U. S. ARMY CORPS OF ENGINEERS

Figure 5-4. Working stress flexural design assumptions for T-sections.

$$M_{rs} = \frac{F_s A_s j d}{12} (\text{ft-lb}) \quad (\text{eq 5-19})$$

And,

$$M_{mm} = \frac{F_m k j b d^2}{12} \left[1 - \frac{t_s}{2k_1 d} \right] (\text{ft-lb}) \quad (\text{eq 5-20})$$

c. *Design for axial compression.*

(1) When determining the capacity of a masonry wall element in compression, the compression reinforcement in the element will be neglected since its contribution is not significant. Only tied compression reinforcement, such as in a column or pilaster will be considered effective. The axial stress in a masonry wall, f_a , is found as follows:

$$f_a = \frac{P}{A_e} (\text{psi}) \quad (\text{eq 5-21})$$

Where:

P = The axial load, lbs.

A_e = The area of the element effective in compression as shown in figure 5-2a and obtained from table 5-3, in².

(2) The design of columns in axial compression is given in chapter 9.

d. *Design for shear.*

(1) For shear design in masonry walls subjected to out-of-plane loading, the shear stress in a masonry element, f_v , is found as follows:

$$f_v = \frac{V}{b_w d} \quad (\text{eq 5-22})$$

Where:

V = The shear load, lbs.

b_w = The width of the masonry element effective in resisting out-of-plane shear as shown in figure 5-2c and given in table 5-1, inches.

d = The depth of the masonry element effective in resisting the shear is shown in figure 5-2c and given in table 5-1, inches. For one bar per cell, $d = d_1$, and for two bars per cell, $d = d_2$.

(2) For shear design in masonry walls subject to in-plane loading (shear walls) the shear stress in a masonry element is found as follows:

$$f_v = \frac{V}{A_e} \quad (\text{eq 5-23})$$

Where:

V = The shear load, lbs.

A_e = The area masonry element effective in resisting in-plane shear as shown in figure 5-2a and obtained from table 5-3, inches.

5-5. Allowable working stresses. The allowable working stresses for masonry, F_m , (CMU and brick) are given in table 5-7. These allowables are based on the masonry compressive strength, f'_m , which either have been assumed or have been determined from prism tests. The assumed f'_m values, 1500 psi for solid units and 1350 psi for hollow units, are for type M and type S mortars. If type N mortar is used, f'_m will be assumed to be 1000 psi for all units. The assumed f'_m values are reasonable and conservative in that they are in the range $\frac{1}{3}$ to $\frac{3}{4}$ of the prism strength. If the designer needs to use higher masonry strengths than the assumed values, prism tests may be required. Generally reinforced masonry will be designed and detailed in conformance with the assumed values given in table 5-7.

TYPE OF STRESS	SOLID UNITS	HOLLOW UNITS ²	SOLID AND HOLLOW UNITS
For Grades of Materials Specified ⁴	$f'_m = 1,500 \text{ psi}^3$	$f'_m = 1,350 \text{ psi}^3$	f'_m
	Building Brick: ASTM C62, Grade MW or SW	Concrete Masonry Units: ASTM C90, Type 1	For materials where ultimate compressive stress (f'_m) is established by approved prism tests, but not to exceed 3,500 psi.
	Facing Brick: ASTM C216, Grade MW or SW	Glazed Structural Facing Units: ASTM C126 Type I	
	Concrete Building Brick: ASTM C55 Type 1	Hollow Brick Unit: ASTM C652 Grade MW or SW	
Concrete Masonry Units: ASTM C90 Type 1			
			But Not To Exceed
COMPRESSION: Axial, Walls, F_a Axial, Columns, F_a Flexural, F_b	Equation 5-24 Equation 9-1 500	Equation 5-24 Equation 9-1 450	Equation 5-24 Equation 9-1 $1/3 f'_m$ 900
SHEAR: No Shear Steel: ⁵ Full Shear Steel: ⁶ Flexural Members Shear Walls	39 Equations 7-1 thru 7-4 117	37 Equations 7-1 thru 7-4 111	$1.0vf'_m$ 50 $3.0vf'_m$ 120 Equations 7-1 thru 7-4
MODULUS: Elasticity Rigidity	1,500,000 600,000	1,350,000 540,000	$1000f'_m$ 3,000,000 $400f'_m$ 1,200,000
BEARING: On Full Area On 1/3 or less of Area ⁷	375 450	338 405	$.25f'_m$ 900 $.30f'_m$ 1,050

¹All allowable stresses will be increased one-third when wind or seismic forces are included, provided the required section or area computed on this basis is not less than that required without wind or seismic forces.

²Stresses will be based on the net section. Figure 5-3 applies.

³Where prism tests are not performed these values of f'_m may be assumed for types M and S mortar when the units comply with the applicable ASTM standard. If type N mortar is used f'_m will be assumed to be 1000 psi for all units.

⁴Minimum compressive strength at 28 days for grout and mortar will be as follows: Grout = 2000 psi, Type S mortar = 1800 psi, Type M mortar = 2500 psi and Type N mortar = 750 psi.

⁵Web reinforcement will be provided to carry the entire shear in excess of 20 psi whenever there is required negative reinforcement and for a distance of one-sixteenth the clear span beyond the point of inflection.

⁶Reinforcement must be capable of taking the entire shear.

⁷This increase will be permitted only when the edges of the loaded and unloaded area is a minimum of one-fourth of the parallel side dimension of the loaded area. The allowable bearing stress on a reasonably concentric area greater than one-third but less than the full area will be interpolated between the values given.

Table 5-7. Allowable working stresses in reinforced masonry¹.

The stresses in the reinforcing steel will not exceed the values shown in table 5-8.

Table 5-8. Allowable working stresses for Grade 60 reinforcing bars.

TYPE OF STRESS	PSI
Tensile	24,000
Compressive	24,000

The allowable axial stress, F_a , can be determined as follows:

$$F_a = 0.20f'_m R \tag{eq 5-24}$$

Where:

R = The stress reduction factor for the wall based on the height to thickness ratio as follows:

$$R = \left[1 - \left[\frac{12h}{40t_n} \right]^3 \right] \tag{eq 5-25}$$

Where:

h = The clear height of the wall, feet.

t_n = The nominal thickness of the wall, inches.

The stress reduction factor limits the axial stress on the wall so that buckling will not occur. When analyzing the top or bottom of a wall, where buckling is not a concern, the stress reduction factor should not be used.

TM 5-809-3/NAVFAC DM-2.9/AFM 88-3, Chap. 3

5-6. Basic reinforcement requirements. The design of steel reinforcing bars will be based on the working stress allowables given in table 5-8.

a. *Minimum bar size.* The minimum bar size will be No. 4.

b. *Maximum bar sizes.* The most commonly used, and preferred, reinforcing steel bar sizes in CMU walls are Nos. 4, 5 and 6. When the design requires the use of larger bars, the bar size will not exceed No. 6 bars in 6-inch CMU walls, No. 7 bars in 8-inch CMU walls and No. 8 bars in 10-inch and 12-inch CMU walls. This provides reasonable steel ratios, reasonable splice lengths, and better distribution of reinforcement. The maximum bar size in masonry columns should be No. 9.

c. *Maximum flexural reinforcement.* There is no maximum flexural reinforcement limit in the working stress design method, however there is a practical maximum. It is not efficient to use a steel ratio, p , that is greater than the balanced-stress steel ratio, p_e . Examining the elastic theory shows that reinforcing steel added to a masonry element with $p > p_e$ provides less than one half the added strength the same amount of steel added to the member with $p < p_e$ provides. Although using $p > p_e$ is not efficient use of the reinforcement, in some instances it may be more economical from a total wall cost standpoint to increase the reinforcement in lieu of increasing the wall thickness. Thus, the decision to use more than balanced steel becomes an economic one and should be decided on a case by case basis.

(1) Table 5-9 lists values of p_e , k and j for varying values of f'_m .

Table 5-9. *Balanced reinforcing steel ratio along with k and j for fully grouted CMU in running bond. $f_y = 60,000$ psi.*

f'_m	p_e	k	j
1350	0.0027	0.287	0.904
1500	0.0030	0.287	0.904
2000	0.0040	0.287	0.904
2500	0.0050	0.287	0.904

(2) Table 5-10 may be used by designers to determine the bar size and spacing that will achieve a near balanced-stress ratio for varying wall thicknesses with one bar per cell. The table also provides the depth to the reinforcement, d ; the balance-stress steel ratio, p_e , the actual steel ratio, p , and the actual depth of the compression stress block, kd ; using the respective bar size and spacing.

Table 5-10. *Balanced reinforcing steel, one bar per cell, fully grouted CMU walls¹ in running bond. See figure 5-2 for maximum effective width. $f'_m = 1350$ psi, $f_y = 60,000$ psi.*

CMU THICK. ²	d	p_e	Reinf. $\approx p_e$	Actual p	Actual k	Actual kd
6	2.81	0.0027	#4 @ 24"	0.0030	0.300	0.84"
			#5 @ 40" ³	0.0028	0.292	0.82"
8	3.81	0.0027	#4 @ 24"	0.0022	0.264	1.01"
			#5 @ 32"	0.0025	0.278	1.06"
			#6 @ 48"	0.0024	0.274	1.04"
10	4.81	0.0027	#4 @ 16"	0.0026	0.283	1.36"
			#5 @ 24"	0.0027	0.287	1.38"
			#6 @ 32"	0.0029	0.296	1.42"
			#7 @ 48"	0.0026	0.283	1.36"
12	5.81	0.0027	#4 @ 16"	0.0022	0.253	1.47"
			#5 @ 24"	0.0027	0.287	1.67"
			#6 @ 32"	0.0024	0.274	1.59"
			#7 @ 40"	0.0026	0.283	1.64"
			#8 @ 48"	0.0028	0.292	1.70"

¹When the walls are partially grouted, the design section will sometimes be a T-beam, however, the difference is usually not significant.

²Masonry unit thicknesses are nominal.

³Note that this spacing exceeds the maximum effective width of six times the nominal wall thickness given in figure 5-2b.

(3) Table 5-11 provides similar information to that given in table 5-10 for CMU with two bars per cell.

Table 5-11. Balanced reinforcing steel, two bars per cell, fully grouted CMU walls¹. $f_m = 1350$ psi, $f_y = 60,000$ psi

CMU THICK. ²	d	p_o	Reinf. $\approx p_o$	Actual p	Actual k	Actual kd
8	5.31	0.0027	#4 @ 16"	0.0024	0.274	1.45"
			#5 @ 24"	0.0024	0.274	1.45"
			#6 @ 32"	0.0026	0.283	1.50"
			#7 @ 40"	0.0028	0.292	1.55"
10	7.06	0.0027	#4 @ 16"	0.0018	0.242	1.71"
			#5 @ 16"	0.0027	0.287	2.03"
			#6 @ 24"	0.0026	0.283	2.00"
			#7 @ 32"	0.0027	0.287	2.03"
			#8 @ 40"	0.0028	0.292	2.06"
12	8.81	0.0027	#5 @ 16"	0.0022	0.264	2.33"
			#6 @ 24"	0.0021	0.259	2.28"
			#7 @ 24"	0.0028	0.292	2.57"
			#8 @ 32"	0.0028	0.292	2.57"

¹When the walls are partially grouted, the design section will be a T-beam, however, the difference is usually not significant.

²Masonry unit thicknesses are nominal.

(4) Tables 5-9, 5-10 and 5-11 are applicable to partially and fully grouted CMU walls, as stated. In partially grouted CMU walls, when the stress block falls below the face shell, that is, when $kd > t_s$ (given in table 5-1), the tables do not apply. With $kd > t_s$, the design will be based on the T-section design method contained herein. In most cases, when one bar is used per cell, the stress block falls within the face shell and when two bars are used per cell, the stress block falls outside the face shell. However, for CMU with $f_m = 1350$ psi, the difference between a T-section beam design and a rectangular section beam design is usually so insignificant that a rectangular beam design will suffice. When providing two bars per cell, the vertical bars will be placed outside the horizontal reinforcement. Details will be provided on the drawings showing this relationship so that the depth to reinforcement assumed in design will be provided during construction. The details should also provide adequate space to allow grout to be placed and vibrated.

d. Minimum reinforcement. All masonry exterior, bearing and shear walls (structural walls) will be reinforced as provided below. There are no minimum reinforcement requirements for nonstructural partitions except around openings as given in chapter 4. In seismic zones 1 through 4, the minimum reinforcement requirements given in TM 5-809-10/NAVFAC P-355/AFM 88-3, Chapter 13 must also be satisfied.

(1) One vertical reinforcing bar will be provided continuously from support to support at each wall corner, at each side of each opening, at each side of control joints, at ends of walls, and elsewhere in the wall panels at a maximum spacing of six feet. This minimum reinforcement will be the same size as the minimum vertical reinforcement provided for flexural stresses.

(2) Horizontal reinforcement will be provided continuously at floor and roof levels and at the tops of walls. Horizontal reinforcement will also be provided above and below openings. These bars will extend a minimum of 40 bar diameters, but not less than 24 inches, past the edges of the opening. For masonry laid in running bond, the minimum horizontal reinforcement should be one No. 4 bar per bond beam. For masonry laid in other than running bond, such as stacked bond, the minimum area of horizontal reinforcement placed in horizontal joints or in bond beams, which are spaced not more than 48 inches on center, will be 0.0007 times the vertical cross sectional area of the wall. Lintel units will not be used in lieu of bond beam units, since lintel units do not allow passage of the vertical reinforcement. If the wall is founded on a concrete foundation wall, the required reinforcement at the floor level may be provided in the top of the foundation wall.

e. Splices of reinforcement. The length of tension and compression lap splices will be $48d_b$, where d_b is the diameter of the bar. All other requirements for the development and splices of reinforcement will be in accordance with ACI 530/ASCE 5.

5-7. Connections between elements. Great care must be taken to properly design and detail connections between the vertical resisting elements (masonry shear walls) and the horizontal resisting elements (diaphragms) of the building so that all elements act together to provide an integral structural system. A positive means of connection will be provided to transfer the diaphragm shear forces into the shear walls. In designing connections or ties, it is necessary to trace the forces through their load paths and also to make every connection along each path adequate and consistent with the basic assumptions and distribution of

TM 5-809-3/NAVFAC DM-2.9/AFM 88-3, Chap. 3

forces. Because joints and connections directly affect the integrity of the structure, their design and fabrication must be adequate for the functions intended. In designing and detailing, it must be recognized that the lateral forces are not static, as assumed for convenience, but dynamic and to a great extent unpredictable. Because of this, it is important to provide the minimum connections required below even when they are not specifically required for design loading. In seismic zones 1 through 4 the minimum connection requirements given in TM 5-809-10/NAVFAC P-355/AFM 88-3, Chapter 13 must also be satisfied. When the design forces on joints and connections between lateral force resisting elements are due to wind, the minimum criteria given in TM 5-809-2/AFM 88-3, Chapter 2, will be followed.

a. Forces to be considered. Forces to be considered in the design of joints and connections are gravity loads; temporary erection loads; differential settlement; horizontal loads normal to the wall; horizontal loads parallel to the wall; and creep, shrinkage, and thermal forces; separately or combined as applicable. Bond beams at roof or floor diaphragm levels must have the reinforcement continuous through control joints to resist the tensile and compressive chord stresses induced by the diaphragm beam action. The connections between the diaphragm and chord (bond beam) members must be capable of resisting the stresses induced by external loadings.

b. Joints and connections. Joints and connections may be made by welding steel reinforcement to structural steel members, by bolting, by dowels, by transfer of tensile or compressive stresses by bond of reinforcing bars, or by use of key-type devices. The transfer of shear may be accomplished by using reinforcing steel extended as dowels coupled with cast-in-place concrete placed between roughened concrete interfaces or by mechanical devices such as embedded plates or shapes. The entire shear loading should be transferred through one type of device, even though a combination of devices may be available at the joint or support being considered. Maximum spacing of dowels or bolts, for load transfer between elements, will not exceed four feet. All significant combinations of loadings will be considered, and the joints and connections will be designed for forces consistent with all reasonable combinations of loadings as given in TM 5-809-1/AFM 88-3, Chapter 1. Details of the connections will be based on rational analysis in accordance with established principles of mechanics.

c. Allowable tension and shear on bolts. The allowable loads for plate, headed, and bent bar anchor bolts embedded in masonry will be determined in accordance with the criteria in ACT 530/ASCE 6. Tables 5-12, 5-13 and 5-14 were developed using that criteria.

Table 5-12. Allowable tension in bolts, B_w , in pounds, based on the compressive strength of masonry.

f_m psi	l_b ¹ or l_{be} ² , inches ³							
	2	3	4	6	7	8	9	10
1350	230	520	920	2080	2830	3690	4670	5770
1500	240	550	970	2190	2980	3890	4930	6080
2000	280	630	1120	2530	3440	4500	5690	7024
2500	310	710	1260	2830	3850	5030	6360	7850
3000	340	770	1380	3100	4220	5510	6970	8600

¹ l_b is the embedment length of the bolt, as shown in figure 5-5. It shall not be less than 4 bolt diameters.

² l_{be} is the edge distance, as shown in figure 5-5.

³When the spacing between bolts is less than two times l_b , the allowable loads will be reduced in accordance with the requirements in ACI 530/ASCE 6. When l_{be} is less than l_b or the distance to an ungrouted cell, the allowable loads will be reduced in accordance with the requirements in ACI 530/ASCE 6.

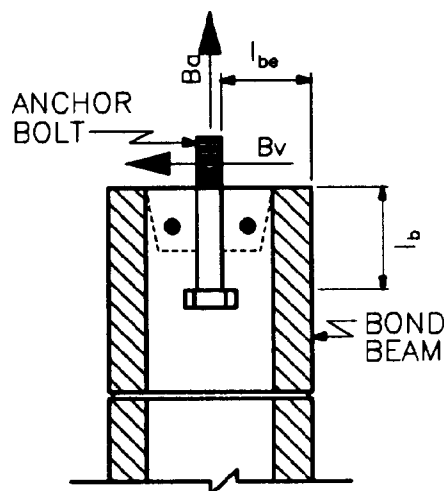

U. S. ARMY CORPS OF ENGINEERS

 Figure 5-5. Effective embedment, l_b , and edge distance, l_{be}

 Table 5-13. Allowable tension in bolts, B_a , in pounds, based on a steel yield strength of 36,000 psi.

BOLT DIAMETER, inches				
$\frac{5}{8}$	$\frac{3}{4}$	$\frac{7}{8}$	1	$1\frac{1}{2}$
2210	3180	4330	5650	7160

 Table 5-14. Allowable shear, B_v ¹, in pounds, based on the listed value of f_m and a steel yield strength of 36,000 psi.

f_m psi	BOLT DIAMETER, inches				
	$\frac{5}{8}$	$\frac{3}{4}$	$\frac{7}{8}$	1	$1\frac{1}{2}$
1350	1330	1730	1870	2000	2120
1500	1330	1780	1920	2050	2180
2000	1330	1910	2060	2200	2330
2500	1330	1910	2180	2330	2470
3000	1330	1910	2280	2440	2580

¹This table is based on an edge distance of 12 bolt diameters or more. Where the edge distance is less than 12 bolt diameters the value of B_a will be reduced by linear interpolation to zero at an edge distance of $1\frac{1}{2}$ inch. All bolts will be grouted in place with a minimum of 1 inch of grout between the bolt and the masonry.

d. *Cautionary notes for designers and detailers.* Avoid connection and joint details which would result in stress concentrations that might result in spalling or splitting of face shells at contact surfaces. To avoid stress concentrations, liberal chamfers, adequate reinforcement, and bearing pads should be used. Avoid direct bearing of heavy concentrated loads on face shells of concrete masonry units. Avoid welding to any embedded metal items which might cause spalling of the adjacent masonry, in particular where the expansion of the heated metal is restrained by masonry. All bolts and dowels which are embedded in masonry will be grouted solidly in place with not less than one inch of grout between the bolt or dowel and the masonry. Expansion anchors should not be used in the connection between major structural elements, including the connection of the horizontal elements (diaphragms) to the vertical elements (shear walls). At tops of piers and columns, vertical bolts will be set inside the horizontal ties. When steel beams are connected to masonry, the connection will allow for the thermal expansion and contraction of the beam. The construction case, where a wide range of temperatures can be expected if the beams are directly exposed to the heat of the sun, will be considered when determining the temperature differential.

CHAPTER 6

REINFORCED MASONRY WALLS

6-1. Introduction. This chapter covers the design of reinforced masonry walls by the working stress method for lateral out-of-plane loads and axial loads. The design of reinforced masonry walls for in-plane lateral loads (shear walls) and axial loads is covered in chapter 7. General design criteria, section properties, and allowable stresses used but not contained herein are covered in chapter 5.

6-2. Design loadings.

a. Lateral loads. Lateral out-of-plane loads on masonry walls are determined from wind forces as given in TM 5-809-1/AFM 88-3, Chapter 1 or from seismic forces as given in TM 5-809-10/NAVFAC P-355/AFM 88-3, Chapter 13.

b. Axial loads. Vertical in-plane compression or tension loads on masonry walls are determined from dead, live, snow, and wind uplift forces as given in TM 5-809-1/AFM 88-3, Chapter 1.

6-3. Structural behavior.

a. Lateral loads. Most masonry walls are designed to span vertically and transfer the lateral loads to the roof, floor or foundation. Normally, the walls are designed as simple beams spanning between structural supports. Simple beam action is assumed even though reinforcement, which is needed to control horizontal flexural cracking at the floor levels or to provide connectivity, may be present and will provide at least partial continuity. Under certain circumstances, such as when a system of pilasters is present, the masonry walls may be designed to span horizontally between pilasters which in turn span vertically to transfer the lateral loads to the horizontal structural support elements above and below.

b. Axial loads. Loads enter the wall from roofs, floors, or beams and are transferred axially to the foundation. When the resultant axial force is tension from wind uplift loadings, mortar tension will not be used to resist these uplift forces. Instead, adequate reinforcement will be provided to anchor the top of wall bond beam to the remainder of the wall and on down to the foundation. If the resultant of the vertical loads which are applied to the wall at any level is not at the center of the wall; that is, it is not concentric; due allowance will be made for the effects of eccentric loading. This includes any moments that are due to eccentric loading as well as any additional moments caused by the rotation of floor or roof elements that frame into the wall.

(1) Uniform loads. Uniform loads enter the wall as line loads, stressing the wall uniformly along its length.

(2) Concentrated loads. When concentrated loads are not supported by structural elements, such as pilasters, they may be distributed over a length of wall equal to the width of bearing plus four times the wall thickness, but not to exceed the center to center distance between concentrated loads. Concentrated loads will not be distributed across control joints.

c. Combined loads. The combined effects of lateral and axial loads may be assumed to act according to the straight-line interaction equations given in this chapter or may be combined by other methods which are based on accepted principles of mechanics.

6-4. Wall design equations. The equations in this paragraph may be used for the design of walls subjected to bending and axial loads. Lateral (wind or seismic) loading will be applied inward and outward on all exterior walls. Both the condition where the moment due to wind loading and the moment due to axial load eccentricity are additive and the condition where they are not additive are shown on figures 6-1 and 6-2, respectively.

a. Bending equations. The horizontal reaction at the bottom of the wall due to the combined effects of eccentric and lateral loads is “ R_a ” and is determined as follows:

$$R_a = \frac{wh}{2} \pm \frac{P_e}{12h} \quad (\text{lb/ft of wall}) \quad (\text{eq 6-1})$$

Where:

P = The axial load, pounds per foot of wall length.

e = the distance from the centerline of the wall to the load P , inches.

h = The height of the wall, feet.

w = The lateral load on the wall, psf.

Note: The “ \pm ” in equation 6-1 refers to the two conditions; (1) where the eccentric and lateral loads are additive, and (2) where the eccentric and lateral loads are not additive. Both conditions will occur on all exterior walls.

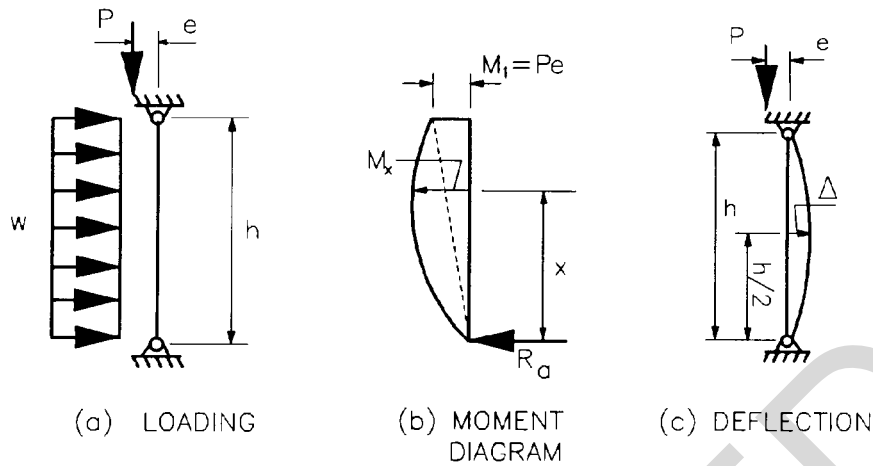

U. S. ARMY CORPS OF ENGINEERS

Figure 6-1. Wall loading, moment, and deflection diagram—Wind and axial load moments additive.

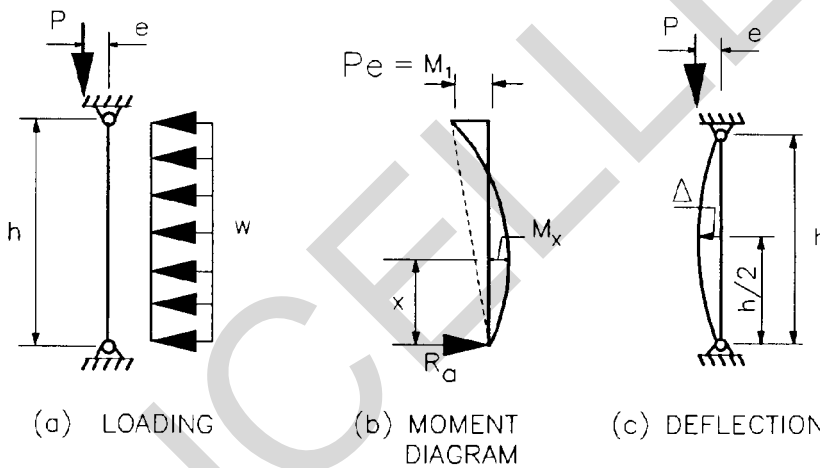

U. S. ARMY CORPS OF ENGINEERS

Figure 6-2. Wall loading, moment, and deflection diagrams—Wind and axial load moments not additive.

The moment at a distance “x” feet from the bottom of the wall is “Mx” and is determined as follows:

$$M_x = R_s x - \frac{wx^2}{2} \text{ (lb-ft/ft)} \tag{eq 6-2}$$

If R_a in equation 6-2 for the additive condition is replaced with its equivalent from equation 6-1, equation 6-2 becomes:

$$M_x = \frac{Pex}{12h} + \frac{whx}{2} \text{ (lb-ft/ft)} \tag{eq 6-3}$$

This M_x equation can then be simplified to:

$$M_x = (x) \left[\frac{Pe}{12h} + \frac{w(h-x)}{2} \right] \text{ (lb-ft/ft)} \tag{eq 6-4}$$

When the spacing between reinforcing bars, S, in inches, is included the equation becomes:

$$M_x = \frac{S_x}{12} \left[\frac{Pe}{12h} + \frac{w(h-x)}{2} \right] \text{ (lb-ft/S)} \tag{eq 6-5}$$

(1) When $w = 0$ and P is eccentric, the maximum bending moment occurs at the top of the wall where $x = h$ and equation 6-5 becomes:

$$M_{\max} = \frac{SPe}{(12)(12)} \text{ (lb-ft/S)} \quad (\text{eq 6-6})$$

(2) When $w > 0$ and P is *not* eccentric, the maximum moment occurs at mid-height of the wall where $x = h/2$ and equation 6-5 becomes:

$$M_{\max} = \frac{Sw h^2}{(12)(8)} \text{ (lb-ft/S)} \quad (\text{eq 6-7})$$

(3) When $w > 0$, P is eccentric, and the moments due to “ w ” and “ Pe ” are additive; the location of the maximum moment can be determined by differentiating the moment equation with respect to x , setting the equation equal to zero, and then solving for x . By performing this operation on equation 6-3, the “ x ” location where the maximum moment occurs can be determined as follows—

$$\frac{dM_x}{dx} = \frac{wh}{2} + \frac{Pe}{12h} - wx = 0$$

Solving for x ;

$$x = \frac{h}{2} + \frac{Pe}{12wh} \text{ (ft)} \quad (\text{eq 6-8})$$

It should be reiterated that this maximum moment condition will occur only when the moment due to the eccentricity of the axial loads and the moment due to the lateral load are additive. Substituting equation 6-8 into 6-2, the maximum moment, per length of wall equal to reinforcing bar spacing, 5, can be found as follows:

$$M_{\max} = \frac{S(R_a)^2}{2w} \text{ (ft-lbs/S)} \quad (\text{eq 6-9})$$

Equations similar to 6-3 through 6-9 can be similarly derived for the case when the moment due to lateral loading and the moment due to eccentric axial loading are not additive.

b. Axial compression equations. The axial stress at any height, h , in a wall is determined as follows:

$$f_a = \left[\frac{P + w_2(h - x)}{A_e} \right] \text{ (psi)} \quad (\text{eq 6-10})$$

Where:

w_2 = The weight of the wall, psf.

A_e = The effective area of the wall, in²/ft.

(1) When $x = h$ (top of wall), there is no wall weight and equation 6-10 becomes:

$$f_a = \frac{P}{A_e} \text{ (psi)} \quad (\text{eq 6-11})$$

(2) When $x = 0$ (bottom of wall) the entire wall weight is included and equation 6-10 becomes:

$$f_a = \frac{P + w_2 h}{A_e} \text{ (psi)} \quad (\text{eq 6-12})$$

c. Combined stresses.

(1) In walls subject to combined axial compression and flexural stresses, the masonry will be designed in accordance with the interaction equations as follows—

$$\left[\frac{f_a}{F_a} + \frac{f_b}{F_b} \right] \text{ OR } \left[\frac{f_a}{F_a} + \frac{M_x}{M_{rm}} \right] \leq 1.00 \quad (\text{eq 6-13})$$

Since a 33% overstress is allowed when wind or seismic loads are considered, the allowable stresses and resisting moment in equation 6-13 may be increased by 33% or interaction equation 6-14 may be used.

$$\left[\frac{f_a}{F_a} + \frac{f_b}{F_b} \right] \text{ OR } \left[\frac{f_a}{F_a} + \frac{M_x}{M_{rm}} \right] \leq 1.33 \quad (\text{eq 6-14})$$

(2) In walls subject to combined axial and flexural stress, the reinforcing steel will be designed using interaction equations as follows:

$$\left[\frac{M_x}{M_{rs}} - \frac{f_a}{F_a} \right] \leq 1.00 \quad (\text{eq 6-15})$$

Since a 33% overstress is allowed when wind or seismic loads are considered, the allowable stress and resisting moment in equation 6-15 may be increased by 33% or interaction equation 6-16 may be used.

$$\left[\frac{M_x}{M_{rs}} - \frac{f_a}{F_a} \right] \leq 1.33 \quad (\text{eq 6-16})$$

TM 5-809-3/NAVFAC DM-2.9/AFM 88-3, Chap. 3

Note that when the reinforcing steel is being checked, the minimum axial stress, $\sim a$, must be used. Note also that it is conservative to *not* consider axial loading ($f_a = 0$) when checking the reinforcing steel stress.

d. *Shear equations.* The shear stress at the bottom of the wall is determined by the following equation:

$$f_v = \frac{R_a}{b_w d} \text{ (psi)} \quad (\text{eq 6-17})$$

Where:

b_w = The width of the masonry element effective in resisting out-of-plane shear as given in chapter 5, inches.

d = The depth of the masonry element effective in resisting shear, given “ d_1 ” for one reinforcing bar per cell and “ d_2 ” for two bars per cell in chapter 5.

6-5. P-delta effect. The “P-delta effect” is the increase in moment and deflection resulting from multiplying the mid-height deflection of a wall (due to lateral and eccentric loadings as discussed above) by the summation of the axial load, P , at the top of the wall and the weight of the top half of the wall. When the height to nominal thickness ratio of the wall is less than 24, the “P-delta effect” is minor and may be neglected. For walls where the height to nominal thickness ratios is greater than 24, the mid-height deflection, Δ_s , will be computed as follows:

When $M_{mid} < M_{cr}$:

$$\Delta_s = \frac{(5)(M_{mid})(h^2)(144)}{(48)(E_m)(I_g)} \text{ (in)} \quad (\text{eq 6-18})$$

When $M_{cr} < M_{mid} < M_r$:

$$\Delta_s = \frac{(5)(M_{cr})(h^2)(144)}{(48)(E_m)(I_g)} + \frac{(5)(M_{mid} - M_{cr})(h^2)(144)}{(48)(E_m)(I_{cr})} \text{ (in)} \quad (\text{eq 6-19})$$

Where:

h = The wall height, feet

M_{mid} = The moment at the mid-height of the panel, including the “P-Delta effect”, inch-pounds.

E_m = The modulus of elasticity, $\text{psi} = 1000f'_m$

I_g = The gross moment of inertia of the wall cross section, in^4 .

I_{cr} = The cracked moment of inertia of the wall cross section, in^4

M_{cr} = The cracking moment strength of the masonry wall, inch-pounds.

M_{rm} = The allowable resisting moment of the masonry wall, inch-pounds.

6-6. Walls with openings. Walls at the edge of openings or between openings are required to resist additional tributary axial and lateral loads. The additional tributary axial loads are due to the weight of masonry above the opening and vertical loads applied to the tributary masonry above the opening. The additional tributary lateral loads are the lateral loads on non-masonry wall components (doors, windows, etc.) that are laterally supported by the adjacent masonry wall elements. The tributary load area width will be measured from the centerline of the openings. Masonry wall elements between and alongside openings that are subjected to combined loading will be designed in accordance with equations 6-13 through 6-16. Due allowance will be made for eccentricity.

6-7. Design aids. Appendix B contains design aids that may be used in the design of reinforced masonry walls. Tables B-1 through B-14 provide the properties of wall stiffeners with varying reinforcement (size, spacing and number of bars per cell), varying wall thickness (6, 8, 10, and 12 inch nominal thickness) and two mortar types (S and N). Tables B-15 through B-50 provide reinforcing steel sizes and spacings for varying wall heights, lateral loads, wall thicknesses, axial loads (with and without eccentricity), using type S mortar.

6-8. Design examples. The following design examples illustrate the development and use of the design aids in Appendix B.

a. *Design example 1.* This illustrative example considers only one combination of wind and eccentric axial loading. When performing a complete wall design, all appropriate load combinations must be considered.

(1) *Given—*

(a) 12-inch CMU loadbearing wall

(b) Wall height (h) = 24 ft

(c) Lateral wind load (w) = 25 lb/ft^2

(d) Axial load (P) = 1500 lb/ft

- (e) Eccentricity (e) = 0.5t, in
- (f) The moments due to lateral wind load and to axial eccentricity are additive.
- (g) $f'_m = 1,350 \text{ lb/in}^2$
- (h) $F'_m = (0.33)f'_m = 450 \text{ lb/in}^2$
- (i) $E'_m = 1000f'_m = 1,350,000 \text{ lb/in}^2$
- (j) $F'_s = 24,000 \text{ lb/in}^2$
- (k) $E'_s = 29,000,000 \text{ lb/in}^2$

$$(l) \quad n = \frac{E'_s}{E'_m} = \frac{29,000,000}{1,350,000} = 21.5$$

(2) Problem—

- (a) Determine the reinforcing bar size and spacing required to resist the given loadings.
- (b) Compare the calculated resisting moment values with the values for resisting moments given in table B-4.
- (c) Compare the reinforcing results from the calculated solution with the direct solution given in table B-47.

(3) Solution. Equations are from chapters 5 and 6. Flexural Check:

- (a) First determine the maximum applied moment that must be resisted by the wall.
Horizontal reaction at the bottom of the wall is R_a :

$$\begin{aligned} R_a &= \frac{P_e}{12h} + \frac{wh}{2} \\ &= \frac{(1500 \text{ lb/ft})[(0.5)(11.625 \text{ in})]}{(12 \text{ in/ft})(24 \text{ ft})} + \frac{(25 \text{ lb/ft}^2)(24 \text{ ft})}{2} \\ &= 30.3 + 300.0 = 330.3 \text{ lb/ft of wall} \end{aligned}$$

Location where maximum moment occurs is “x” distance from the bottom of the wall:

$$\begin{aligned} M_x &= R_a x - \frac{wx^2}{2} \\ &= (330.3 \text{ lb})(x) - \frac{(25 \text{ lb/ft}^2)(x^2)}{2} \end{aligned}$$

Differentiating with respect to x;

$$\frac{dM_x}{dx} = R_a - wx = 330.3 - 25x = 0$$

Solving for x;

$$x = \frac{330.3}{25} = 13.2 \text{ ft bottom of wall}$$

Maximum moment in the wall is M_{\max}

$$\begin{aligned} M_{\max} &= (330.31b)(13.2 \text{ ft}) - \frac{(25 \text{ lb/ft}^2)(13.2\text{ft})^2}{2} \\ &= 4360 - 2178 = 2182 \text{ ft-lb/foot of wall} \end{aligned}$$

Assume the reinforcement spacing, S, is 24 inches and determine the design maximum moment, Design M_{\max} , in the wall as follows:

$$\begin{aligned} \text{Design } M_{\max} &= (2182 \text{ ft-lb} \times 24 \text{ in}) / (12 \text{ in/ft}) \\ &= 4364 \text{ ft-lb/S} \end{aligned}$$

- (b) Determine the resisting moments n the wall assuming 1-#6 @ 24 in. o.c. Assume the flexural compression area is rectangular and compare to the T-section design from table B-4.

Masonry resisting moment is M_{rm} :

$$M_{rm} = \frac{F'_m k j b d^2}{2(12)}$$

Where:

$$\begin{aligned} p &= A_s / b d_1 = (0.44 \text{ in}^2) / (24 \text{ in})(5.81 \text{ in}) = 0.0032 \\ np &= (21.5)(0.0032) = 0.0688 \\ k &= [(np)^2 + 2np]^{1/2} - np \\ &= [(0.0688)^2 + (2)(0.0688)]^{1/2} - 0.0688 \\ &= [0.00473 + 0.1376]^{1/2} - 0.0688 = 0.308 \\ j &= 1 - k/3 = 1 - 0.308/3 = 0.897 \end{aligned}$$

TM 5-809-3/NAVFAC DM-2.9/AFM 88-3, Chap. 3

$$kd = 0.308(5.81 \text{ in}) = 1.79 \text{ in}$$

Note that kd is greater than the face shell thickness, therefore the actual design section would be a T-section. The following will show that the difference generated by assuming a rectangular section is negligible.

$$M_{rm} = \frac{(450 \text{ lb/in}^2)(0.308)(0.897)(24)(5.81 \text{ in})^2}{2(12)}$$

$$= 4,196 \text{ ft-lb/S} \approx 4,147 \text{ ft-lb/S (table B-4)}$$

Reinforcing steel resisting moment is M_{rs} :

$$M_{rs} = \frac{F_s A_s j d}{12}$$

$$M_{rs} = \frac{(24,000 \text{ lb/in}^2)(0.44 \text{ in}^2)(0.897)(5.81)}{12}$$

Note that the difference between the T-section analysis moments from table B-4 and the computed rectangular section moments is negligible (approximately 1%).

(c) To illustrate the derivation of the table values, a T-section analysis will be performed.

$$k_T = \frac{np + \frac{1}{2}(t_s/d)^2}{np + (t_s/d)}$$

$$= \frac{(21.5 \times 0.0032) + \frac{1}{2}(1.5/5.81)^2}{(21.5 \times 0.0032) + (1.5/5.81)}$$

$$= 0.312$$

$$j_T = \frac{6 - 6(t_s/d) + 2(t_s/d)^2 + (t_s/d)(1/2pn)}{6 - 3(t_s/d)}$$

$$j_T = \frac{6 - [6(1.5/5.81)] + 2(1.5/5.81)^2}{6 - 3(1.5/5.81)}$$

$$+ \frac{(1.5/5.81)[\frac{1}{2} \times 0.0032 \times 21.5]}{6 - 3(1.5/5.81)} = 0.902$$

$$M_{rsT} = \frac{A_s F_s j_T d}{12}$$

$$M_{rsT} = \frac{(0.44 \text{ in}^2)(24,000 \text{ lb/in}^2)(0.902)(5.81)}{12}$$

$$= 4611 \text{ ft-lbs} \approx 4603 \text{ ft-lbs (table B-4)}$$

$$M_{rsT} = \frac{450[1 - 1.5/(2 \times 0.312 \times 5.81)](24)(1.5)(0.902)(5.81)}{12}$$

$$= 4147 \text{ ft-lbs} \approx 4147 \text{ ft-lbs (table B-4)}$$

Note that since wind loadings are a part of the loading combination, the resisting moments of the wall cross section may be increased by 33%. Thus, the design resisting moments for the masonry and the reinforcing steel, respectively are:

$$M_{rmT} = 1.33(4147 \text{ ft-lb/S}) = 5,516 \text{ ft-lb/S}$$

$$M_{rsT} = 1.33(4611 \text{ ft-lb/S}) = 6,133 \text{ ft-lb/S}$$

Note: The masonry resisting moment controls the design:

$$M_{rmT} = 5,516 \text{ ft-lb/S} > M_{max} = 4,364 \text{ ft-lb/S}$$

....O.K.

Axial Load Check: For the 12-inch CMU wall with reinforcing spaced at 24 inches o.c., the effective area in compression, A_e , is 68 in²/ft and the weight of the wall, W_2 , is 102 lb/ft².

The axial compressive stress in the wall, f_a , is determined as follows:

$$f_a = \frac{P + (w_2)(h - x)}{A_e}$$

$$f_a = \frac{(1500 \text{ lb}) + (102 \text{ lb/ft}^2)(24 \text{ ft} - 13.2 \text{ ft})}{68 \text{ in}^2} = 38.3 \text{ lb/in}^2$$

The allowable axial compressive stress in wall is F_a :

$$F_a = 0.2f'_m \left[1 - \left[\frac{12h}{40t_n} \right]^3 \right]$$

$$F_a = (0.2)(1350) \left[1 - \left[\frac{(12)(24)}{(40)(12)} \right]^3 \right] = 212.0 \text{ lb/in}^2$$

$f_a = 38.3 \text{ lb/in}^2 < F_a = 212.0 \text{ lb/in}^2$...O.K.

Combined Load Check: Since the masonry resisting moment controls, only the masonry need be checked in the combined stress condition. The unity equation will be used. Since wind loadings are a part of the loading combination, the allowable axial compressive stress, F_a , may be increased by 33%.

$F_a = 1.33(212.0 \text{ lb/in}^2) = 282.0 \text{ lb/in}^2$

$$\frac{f_a}{F_a} + \frac{M_{max}}{M_r} \leq 1.0$$

$$\frac{38.3 \text{ lb/in}^2}{282.0 \text{ lb/in}^2} + \frac{4364 \text{ ft-lb}}{5516 \text{ ft-lb}} = 0.14 + 0.79 \leq 1.00$$

...O.K.

Direct solution (table B-47): Using the design parameters given above; the 1-#6 bar spaced at 24 inches o.c. which was determined by the design calculations; is sufficient reinforcement.

(4) *Summary.* 1-#6 bar per cell spaced at 24 inches o.c. is sufficient.

b. Design example 2. This illustrative example considers only one combination of wind and eccentric axial loading. When performing a complete wall design, all appropriate load combinations must be considered.

(1) *Given:*

- (a) 12-inch CMU wall
- (b) Wall height (h) = 19'-4"
- (c) Lateral wind load (w) = 22 lb/ft²
- (d) Axial load (P) = 650 lb/ft
- (e) Eccentricity (e) = t/3
- (f) $f'_m = 1350 \text{ lb/in}^2$
- (g) $F_s = 24,000 \text{ lb/in}^2$

(2) *Problem.* Find the required spacing of #6 bars using the tables in appendix B and linear interpolation.

(3) *Solution.* Interpolating for wall height, axial loading, and wind loading.

Table B-40; P = 500 lb/ft, e = t/3

Wall Ht(ft)	Wind, lb/ft ²		
	20	22	25
20	56	52.8	48
19.33		57.1	
18	72	65.6	56

Table B-43, P = 1000 lb/ft, e = t/3

Wall Ht(ft)	Wind, lb/ft ²		
	20	22	25
20	56	49.6	40
19.33		53.3	
18	64	60.8	56

$S_{max} = 57.1 - (57.1 - 53.3)[(650 - 500)/500] = 56 \text{ inches o.c.}$

(4) *Summary.* The wall will resist the given loading with #6 bars spaced at 56 inches on center.

c. Design example 3. This illustrative example considers only one combination of wind and eccentric axial loading. When performing a complete wall design, all appropriate load combinations must be considered.

(1) *Given.*

- (a) 8-inch CMU wall
- (b) Wall height (h) = 16 ft
- (c) Wall length (L) = 30 ft

TM 5-809-3/NAVFAC DM-2.9/AFM 88-3, Chap. 3

(d) Lateral wind load (w) = 30 lb/ft². The wind load is positive (inward) on the exterior face of the wall.

(e) Axial load (P) = 300 lb/ft.

(f) Eccentricity (e) = 1 inch. The axial load is applied on the interior side of the wall center line causing a condition where the eccentric and lateral load moments are *not* additive.

(g) $f'_m = 1350 \text{ lb/in}^2$

(h) $F_s = 24,000 \text{ lb/in}^2$

(i) As shown in figure 6-3, a 12 feet wide by 14 feet high door is located in the wall panel. One edge of the door is 6 feet 8 inches from the wall corner.

(2) *Problem.* Design a stiffener at the door jamb that will resist the applied lateral and axial loads.

(3) *Solution.* Assume that the edge stiffener resists the wind load between the middle of the door and the middle of the 6'-8" wall panel. Also, assume that the stiffener resists the wall weight and the axial load to the middle of the door plus the width of the stiffener.

(a) Determine the wind load, W_L , on the edge stiffener.

$$W_L = w \times L_w$$

Where:

L_w = The tributary width of the load to the jamb, feet.

$$W_L = (30 \text{ lbs/ft}^2) \left[\frac{12 \text{ ft} + 6.67 \text{ ft}}{2} \right] = 280 \text{ lb/ft}$$

(b) Determine the moment resulting from the eccentricity of the axial load, M_{ecc} .

$$M_{ecc} = PL_p e$$

Where:

L_p = The distance from the edge of the stiffener to the center line of the door, feet.

$$M_{ecc} = \frac{(300 \text{ lbs/ft})(1.33 \text{ ft} + 6 \text{ ft})(1 \text{ in})}{12 \text{ in/ft}} = 183 \text{ ft-lbs}$$

(c) Determine the distance, x , from the bottom of the wall to where the maximum moment in the edge stiffener occurs.

$$x = \frac{h}{2} - \frac{PL_p e}{W_L h}$$

$$x = \frac{16 \text{ ft}}{2} - \frac{183 \text{ ft-lbs}}{(280 \text{ lb/ft})(16 \text{ ft})} = 7.96 \text{ ft}$$

(d) Determine the maximum moment in the edge stiffener, M_{max} , as follows:

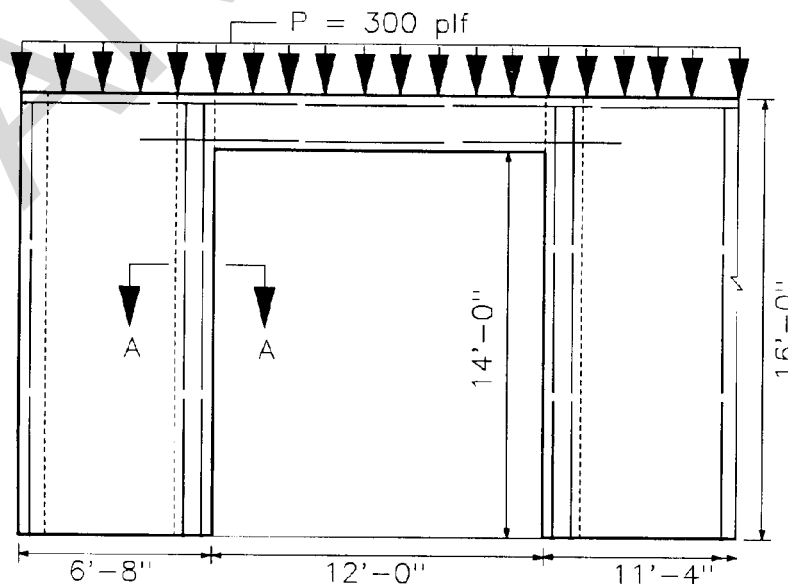

U. S. ARMY CORPS OF ENGINEERS

Figure 6-3. Example 3 wall elevation.

$$M_{\max} = R_a x - \frac{w_L x^2}{2}$$

Where:

R_a = The reaction at the bottom of the wall, pounds.

$$= \frac{W_L h}{2} - \frac{P L_p e}{h} = \frac{(280 \text{ lb/ft})(16 \text{ ft})}{2} - \frac{(183 \text{ ft-lbs})}{16} = 2229 \text{ lbs}$$

$$M_{\max} = (2229)(7.96) - \left[\frac{(280)(7.96)^2}{2} \right] = 8872 \text{ ft-lbs}$$

(e) Determine the axial load stress on the edge stiffener, f_a . Assume the lintel over the door is fully grouted from the top of the opening to the top of the wall.

$$f_a = \frac{W_3(h-x)L_s + R_L}{L_s t}$$

Where:

w_3 = The weight of the stiffener, lbs/ft.

L_s = The width of the stiffener, feet.

t = The thickness of the stiffener, inches.

R_L = The lintel reaction, lbs.

$$= (P)(L_p) + (w_2)(d)(L_L/2)$$

Where:

w_2 = The weight of masonry above the opening, psf.

d = The height of the lintel, feet.

L_L = The length of the lintel, feet.

$$R_L = (300 \text{ lb/ft} \times 7.33 \text{ ft}) + (92 \text{ lbs/ft}^2)(2 \text{ ft})(12 \text{ ft}/2) = 3303 \text{ lbs}$$

$$f_a = \frac{(140 \text{ lbs/ft})(16 \text{ ft}) - 7.96 \text{ ft}(1.3 \text{ ft}) + 3303 \text{ lbs}}{(1.3 \text{ ft})(12 \text{ in/ft})(11.62 \text{ in})}$$

$$= 26.3 \text{ lbs/in}^2$$

(f) Determine the allowable axial stress, F_a .

$$F_a = 0.20 f'_m \left[1 - \left[\frac{12h}{40t} \right]^3 \right]$$

$$= (0.20)(1350) \left[1 - \left[\frac{(12)(16)}{(40)(12)} \right]^3 \right] = 253 \text{ lbs/in}^2$$

(g) Rearrange the interaction equation and determine the required resisting moment, Required M_r .

$$\begin{aligned} \text{Required } M_r &= \frac{M_{\max}}{1.33 - (f_a/F_a)} \\ &= \frac{8872 \text{ ft-lbs}}{1.33 - [(26.3 \text{ lbs/in}^2)/(253 \text{ lbs/in}^2)]} \\ &= 7236 \text{ ft-lbs} \end{aligned}$$

From table B-7 two 8 inch wide 12 inch deep stiffeners with 2-#6 bars furnish a resisting moment, Furnished M_r , as follows:

$$\text{Furnished } M_r = 2(3997 \text{ ft-lbs}) = 7994 \text{ ft-lbs}$$

$$\text{Furnished } M_r = 7994 \text{ ft-lbs} > \text{Required } M_r = 7236 \text{ ft-lbs}$$

...O.K.

(h) Check the combined axial and bending stresses as follows:

$$\frac{f_a}{F_a} + \frac{M_x}{M_{rm}}$$

$$\frac{26.3 \text{ psi}}{253 \text{ psi}} + \frac{8872 \text{ ft-lbs}}{7994 \text{ ft-lbs}} = 0.10 + 1.11 = 1.21 < 1.33$$

...O.K.

(4) *Summary.* A 12 inch by 16 inch wall stiffener with 4-#6 bars, as shown in figure 6-4, will resist the given loads.

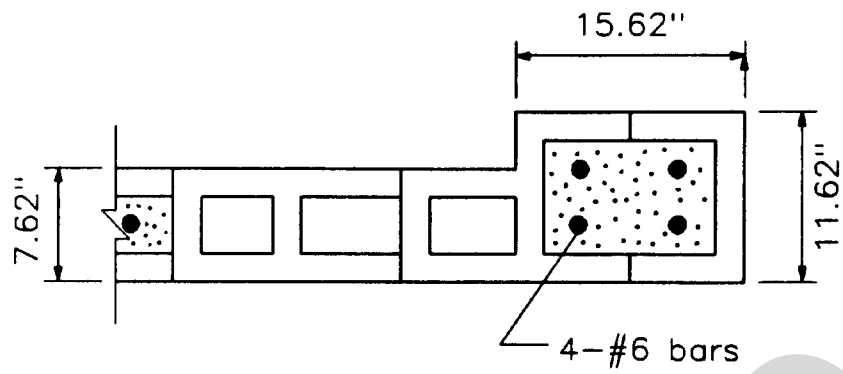

U. S. ARMY CORPS OF ENGINEERS

Figure 6-4. Section A through wall stiffener.

CANCELLED

CHAPTER 7

REINFORCED MASONRY SHEAR WALLS

7-1. Introduction. This chapter contains design requirements for reinforced masonry shear walls, not including seismic requirements. Requirements for shear walls in buildings located in seismic zones 1 through 4 are given in TM 5-809-10/NAVFAC P-355/AFM 88-3, Chapter 13, Seismic Design for Buildings. Except as contained herein, design criteria, section properties, material properties, design equations, and allowable stresses are contained in chapter 5.

7-2. General. A masonry shear wall is any masonry wall, external or internal, which resists externally applied in-plane horizontal forces. A shear wall is a vertical element in the building lateral load resisting system. It transfers horizontal forces vertically downward from a diaphragm above to a diaphragm or a foundation below. Thus, horizontal wind or seismic forces are collected at floor or roof diaphragm levels and transferred to the building foundation by the strength and rigidity of the shear walls. A shear wall may be considered analogous to a plate girder cantilevered off the foundation in a vertical plane. The wall performs the function of a plate girder web and the integral vertical reinforcement at the ends of wall panels, between control joints, function as the beam flanges. Pilasters or floor diaphragms, if present, function as web stiffeners. Axial, flexural, and shear forces must be considered in the design of shear walls, including the tensile and compressive axial stresses resulting from loads tending to overturn the wall.

7-3. Allowable shear stresses. The allowable shear stress in a shear wall is dependent upon the magnitude of the ratio of $M/(Vd)$, where M is the maximum moment applied to the wall due to the in-plane shear force, V , and d is the effective length of the wall. Therefore, if the shear wall is assumed fixed at the top and bottom (a multistory shear wall), $M = \frac{1}{2}hV$, and $M/(Vd)$ becomes $h/2d$, where h is the height of wall. However, if the shear wall is assumed fixed at the bottom only, (a single-story cantilevered shear wall), $M = hV$, and M/Vd becomes h/d . Figure 7-1 illustrates these conditions.

The allowable shear stress is also dependent upon whether or not shear reinforcement is provided. If the calculated shear stress, f_{vm} , exceeds the allowable shear stress, F_{vm} , then shear reinforcement will be provided. The shear reinforcement will be designed to carry the entire shear force. The following equations illustrate the limitations and requirements of determining the allowable shear stress in a shear wall.

a. No shear reinforcement provided. The calculated shear stress, f_{vm} , shall not exceed the allowable shear stress, F_{vm} .

$$\text{If, } \frac{M}{Vd} < 1.0$$

Then,

$$F_{vm} = \frac{1}{3} \left[4 - \frac{M}{Vd} \right] (f'_m)^{1/2} \text{ (psi)} \quad \text{(eq 7-1)}$$

But,

$$F_{vm} \leq 80 - 45 \left[\frac{M}{d} \right] \text{ (psi)} \quad \text{(eq 7-1a)}$$

$$\text{If, } \frac{M}{Vd} \geq 1.0$$

Then,

$$F_{vm} = 1.0(f'_m)^{1/2} \quad \text{(eq 7-2)}$$

But,

$$F_{vm} \leq 35 \text{ psi} \quad \text{(eq 7-2a)}$$

b. Shear reinforcement provided. When firm exceeds F_{vm} , shear reinforcement will be provided and designed to carry the entire shear force. The calculated shear stress in the reinforcement, f_{vs} , shall not exceed the allowable shear stress, F_{vs} .

$$\text{If, } \frac{M}{Vd} < 1.0$$

Then,

$$F_{vs} = \frac{1}{2} \left[4 - \frac{M}{Vd} \right] (f'_m)^{1/2} \text{ (psi)} \quad \text{(eq 7-3)}$$

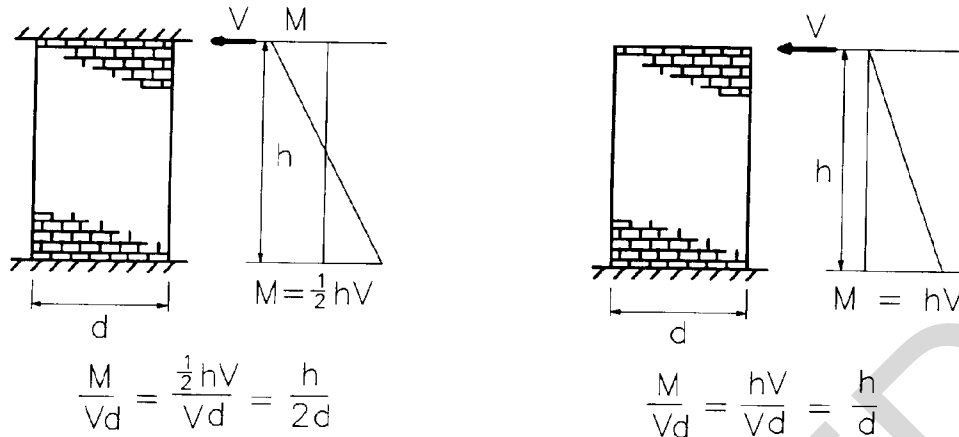

(a) Masonry shear wall fixed top and bottom. Shear walls between floors.

(b) Masonry shear wall fixed at bottom only. One story cantilever wall.

U. S. ARMY CORPS OF ENGINEERS

Figure 7-1. M/Vd ratios for shear walls.

But,

$$F_{vs} \leq 120 - 45 \left[\frac{M}{Vd} \right] \text{ (psi)} \quad \text{(eq 7-3a)}$$

If, $\frac{M}{Vd} \geq 1.0$

Then,

$$F_{vs} = 1.5(f'_m)^{1/2} \text{ (psi)} \quad \text{(eq 7-4)}$$

But,

$$F_{vs} \leq 75 \text{ psi} \quad \text{(eq 7-4a)}$$

The ratio of $M/(Vd)$ will always be taken as a positive number. The values of F_{vm} and F_{vs} may be increased by a factor of 1.33 when wind or seismic loads are considered in the loading combination.

7-4. Design Considerations.

a. *Shear Stresses.* The calculated shear stress, f_{vm} , will be determined as follows:

$$f_{vm} = \frac{V}{td} \quad \text{(eq 7-5)}$$

Where:

V = The total shear load, pounds.

t = The actual thickness of shear wall section for solid grouted masonry or the equivalent thickness of a partially grouted hollow masonry wall, inches. (See Chapter 5 for the equivalent thicknesses).

d = The actual length of the shear wall element, inches.

(To be more exact, the actual wall panel length minus the tension reinforcement cover distance may be used). When the allowable shear stress, F_{vm} , is exceeded, horizontal and vertical shear reinforcement must be provided. The horizontal shear steel will be designed to carry the entire in-plane shear force. The area of shear reinforcement, A_v , will be determined as follows:

$$A_v = \frac{Vs}{F_s d} \text{ (in}^2\text{)} \quad \text{(eq 7-6)}$$

Where:

s = The spacing of the shear reinforcement, inches.

F_s = the allowable tensile stress in the reinforcement, psi.

Horizontal shear reinforcement will be uniformly distributed over the full height of the wall. Shear reinforcement will consist of deformed bars, thus joint reinforcement that is in the wall to control cracking will not be considered as shear reinforcement. The vertical spacing of shear reinforcement will not exceed the lesser of $d/2$ or 48 inches. Shear reinforcement will be terminated with a standard hook or will have an embedment length beyond the vertical reinforcing at the end of the wall panel. The hook or embedded extension will be turned up, down, or extended horizontally. Vertical deformed bar reinforcement that is at least equal to one-third A_v will be provided in all walls requiring shear reinforcement. This vertical reinforcement will be uniformly distributed and will not exceed a spacing of 48 inches.

b. Shear stresses from seismic loadings. When designing shear walls for buildings in seismic zones 1 through 4, the increase in the seismic shear forces required in TM 5-809-10/NAVFAC P-355/AFM 88-3, Chapter 13 will be included.

c. Other shear wall stresses.

(1) The axial stresses caused by dead and live loads from roofs and floors will be considered in design of shear walls.

(2) The flexural stresses caused by moments from lateral in-plane shear force applied to the top of the wall or by the diaphragm will also be considered in design. This in-plane moment is Vh for cantilever shear walls with fixed ends.

(3) The combined effects of axial and bending stresses must be considered. The unity equation or other methods using accepted principles of mechanics will be used.

7-5. Rigidity.

a. General. The magnitude of the total lateral forces at any story level depends upon the structural system as a whole. Also, the proportion of the total horizontal load that is carried by a particular shear wall element is based on the rigidity of the wall element relative the combined rigidities of all the wall elements on that same level. The relative rigidities of shear wall elements are inversely proportional to their deflections when loaded with a unit horizontal force. The total deflection at the top of a shear wall element is the sum of the shear deformation and flexural deflection (Figure 7-2) plus any additional displacement that may occur due to rotation at the base. For most shear walls in ordinary buildings, shear deformation is the major contributor to in-plane deflection.

b. Factors affecting rigidity.

(1) Control joints are complete structural separations that break the shear wall into elements. The elements must be considered as isolated structural members during shear wall rigidity analyses. The number

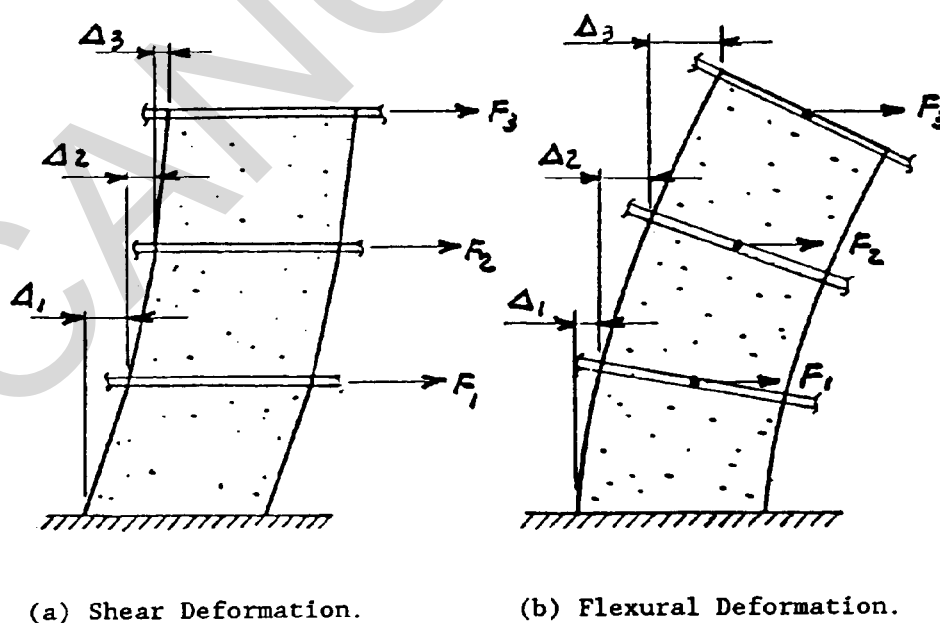

Figure 7-2. Shear wall deformation.

TM 5-809-3/NAVFAC DM-2.9/AFM 88-3, Chap. 3

and location of control joints within the total length of a wall may significantly affect element rigidities, especially flexural deformation.

(2) Openings for doors, windows, etc., reduce the rigidity of shear wall elements. If openings are significantly large or are significantly large in number, they should be considered in rigidity analyses as given in paragraph 7-7.

(3) A shear wall element which is structurally internal at its end with a shear wall that is normal to the element, forming an “L” or “T” in-plan shape, is called a corner element. The rigidity of a corner element is greater than that of a straight element. The amount of increase in rigidity is difficult to quantify but may be taken into account empirically when rigidity analyses are done using the method given in this chapter.

(4) Since shear walls are by nature, very rigid, rotation of the foundation can greatly influence the overall rigidity of a wall. However, the rotational influence on relative rigidities of walls for purposes of horizontal force distribution may not be as significant. Considering the complexities of soil behavior, a quantitative evaluation of the foundation rotation is generally not practical, but a qualitative evaluation, recognizing the limitations and using good judgment, should be a design consideration. It is usually assumed either that the foundation soil is unyielding or that the soil pressure varies linearly under the wall when the wall is subjected to overturning. These may not always be realistic assumptions, but are generally adequate for obtaining the relative rigidities required for design purposes.

7-6. Distribution of Forces to Shear Walls.

a. General. The distribution of lateral forces by different types of diaphragms is discussed in TM 5-809-10/NAVFAC P-355/AFM 88-3, Chap. 13, Seismic Design For Buildings. A brief description is provided herein.

b. Translational shears. The distribution of lateral story level shears from a diaphragm to the vertical resisting elements (in this case, masonry walls acting as shear walls) is dependent upon the relative stiffness of the diaphragm and the shear walls. A rigid diaphragm is assumed to distribute horizontal forces to the masonry shear walls in direct proportion to the relative rigidities of the shear walls. Under symmetrical loading, a rigid diaphragm will cause all vertical shear wall elements to deflect equally with the result being that each element will resist the same proportion of lateral force as the proportion of rigidity that element provides to the total rigidity of all the elements in the same level and direction. Flexible diaphragms, on the other hand, are considered to be less rigid than shear walls and will distribute the lateral forces to the wall elements in a manner analogous to a continuous beam without regard to the rigidity of the walls. A flexible diaphragm is considered incapable of resisting torsional rotational moments (see below).

c. Rotational shears. In a rigid diaphragm, when the center of gravity of the lateral forces fails to coincide with the center of rigidity of the supporting shear wall elements, a torsional moment will be generated within the rigid diaphragm. Provisions will be made to account for this torsional moment in accordance with TM 5-809-10/NAVFAC P-355/AFM 88-3, Chap. 13, Seismic Design For Buildings.

d. Maximum shear wall deflection. Roof and floor diaphragms, must be capable of transmitting horizontal shear forces to the shear walls without exceeding a deflection that which would damage the vertical elements. The maximum allowable deflection for horizontal diaphragms in buildings utilizing masonry shear walls will be as follows:

$$\text{Deflection} = \frac{h^2 F_b}{0.01 E_m t} \quad (\text{eq 7-7})$$

Where:

F_b = The allowable flexural compressive stress in masonry, psi.

$$= (0.33)f'_m$$

E_m = The modulus of elasticity of masonry, psi.

$$= (1000)f'_m \text{ for CMU}$$

t = The effective thickness of the wall, inches.

This equation is neither exact nor technically correct. However, its primary function is to force the designer to think about limiting the deflection of the diaphragm to a value that will not adversely affect, architecturally, the completed wall.

7-7. Effects of Openings in Shear Walls. The effects of openings on the ability of shear walls to resist lateral forces must be considered. If openings are very small, their effect on the overall state of stress in a shear wall will be minor. Large openings will have a more pronounced effect. When the openings in a shear wall become so large that the resulting wall approaches an assembly similar to a rigid frame or a series of

elements linked by connecting beams, the wall will be analyzed accordingly. It is common for openings to occur in regularly spaced vertical rows (or piers) throughout the height of the wall with the connections between the wall sections within the element being provided by either connecting beams (or spandrels) which form a part of the wall, or floor slabs, or a combination of both. If the openings do not line up vertically and/or horizontally, the complexity of the analysis is greatly increased. In most cases, a rigorous analysis of a wall with openings is not required. When designing a wall with openings, the deformations must be visualized in order to establish some approximate method to analyze the stress distribution of the wall. Figure 7-3 gives a visual description of such deformations. The major points that must be considered are; the lengthening and shortening of the extreme sides (boundaries) due to deep beam action, the stress concentration at the corner junctions of the horizontal and vertical components between openings, and the shear and diagonal tension in both the horizontal and vertical components.

a. Relative rigidities of piers and spandrels. The ease of analysis for walls with openings is greatly dependent upon the relative rigidities of the piers and spandrels, as well as the general geometry of the building. Figure 7-4 shows two extreme examples of relative rigidities of exterior walls of a building. In figure 7-4(a) the piers are very rigid relative to the spandrels. Assuming a rigid base, the shear walls act as vertical cantilevers. When a lateral force is applied, the spandrels act as struts with end moments—thus the flexural deformation of the struts must be compatible with the deformation of the cantilever piers. It is relatively simple to determine the forces on the cantilever piers by ignoring the deformation characteristics of the spandrels. The spandrels are then designed to be compatible with the pier deformations. In figure 7-4(b), the piers are flexible relative to the spandrels. In this case, the spandrels are assumed to be infinitely rigid and the piers are analyzed as fixed-end columns. The spandrels are then designed for the forces induced by the columns. The calculations of relative rigidities for both cases shown in figure 7-4 can be aided by the use of the wall deflection charts given later in this chapter. For cases of relative spandrel and pier rigidities other than those shown, the analysis and design becomes more complex.

b. Methods of Analysis. As stated above, approximate methods of analyzing walls with openings are generally acceptable. A common method of determining the relative rigidity of a shear wall with openings is given in the design example in this chapter. For the extreme cases shown in figure 7-4, the procedure is straight-forward. For other cases, a variation of assumptions may be used to determine the most critical

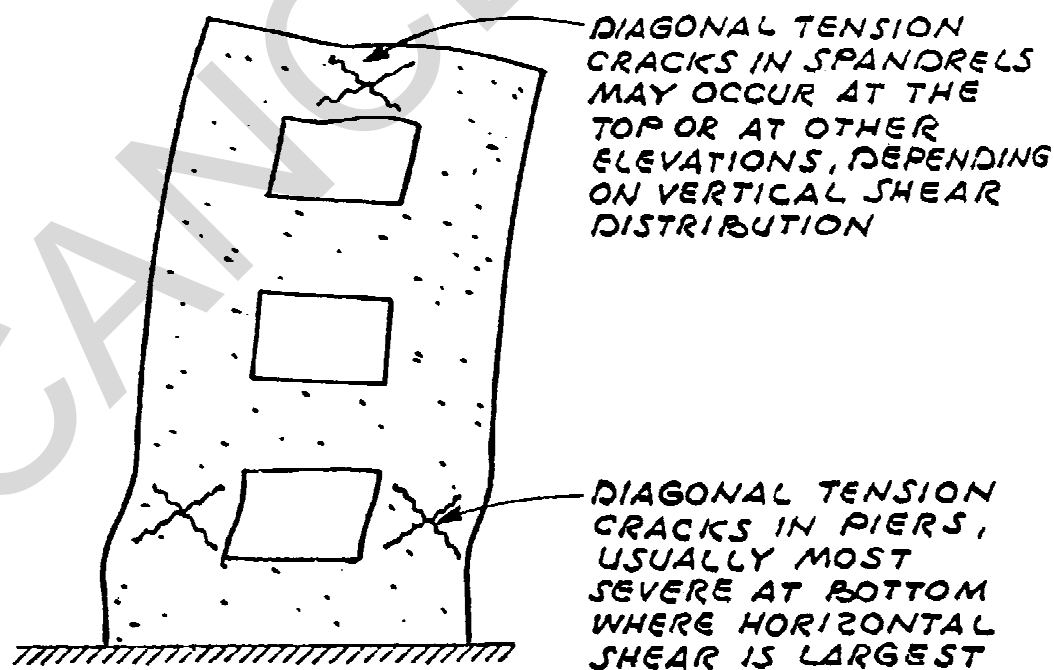

U. S. ARMY CORPS OF ENGINEERS

Figure 7-3. Deformation of shear wall with openings.

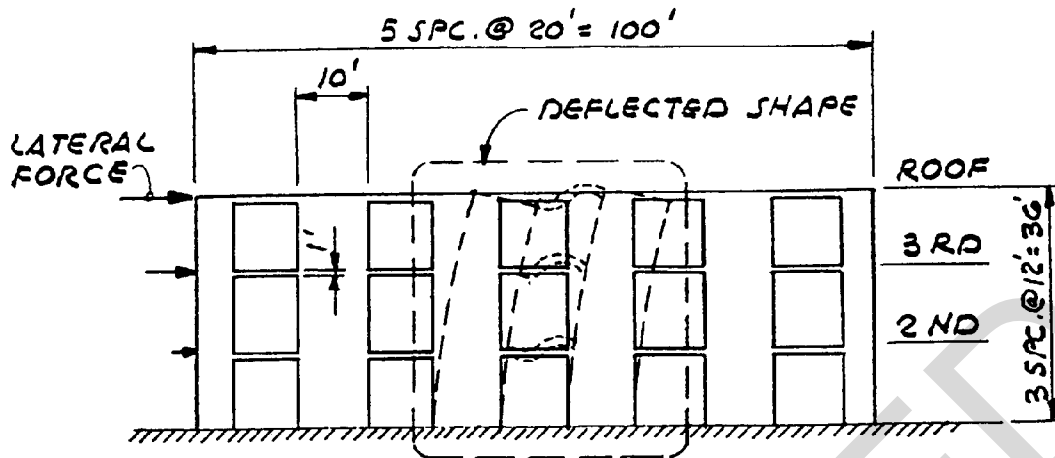

(a) Rigid Piers and Flexible Spandrel.

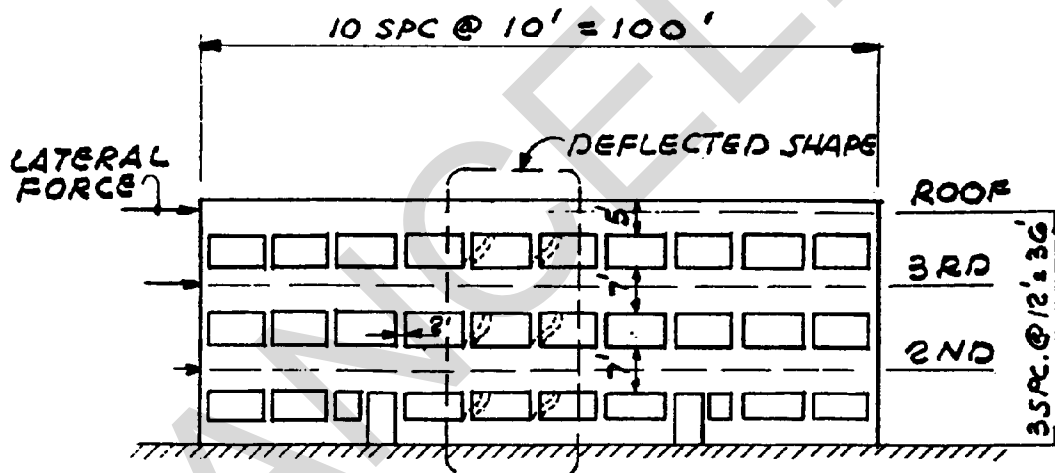

(b) Flexible Piers and Rigid Spandrel.

U. S. ARMY CORPS OF ENGINEERS

Figure 7-4. Relative rigidities of piers and spandrels.

loads on various elements, thus resulting in a conservative design. In some cases a few additional reinforcing bars, at little additional cost, can greatly increase the strength of shear walls with openings. However, when the reinforcement requirements or the resulting stresses of this approach appear excessively large, a rigorous analysis may be justified.

7-8. Shear Wall Rigidity Analysis. The rigidity of a shear wall element is inversely proportional to its deflection, thus rigidity has units of kips per inch. The relative rigidity of a wall element is usually obtained by inverting the deflection caused by a unit horizontal load. The parameters in the rigidity equations for shear wall elements are: the dimensions of height, length, and thickness; the modulus of elasticity, E_m ; the modulus of rigidity or shear modulus, E_v ; and the fixity conditions of support of the wall element at top and bottom.

a. *Wall Deflections.* When a horizontal shear force is applied at the top of a masonry wall or pier element, it will produce a deflection. This deflection is the sum of the deflection due to flexure plus the deformation due to shear. When both ends (top and bottom) of the element are fixed, the total deflection, Δ_f , is defined as follows:

$$\Delta_f = \Delta_b + \Delta_v = \frac{Vh^3}{12E_m I} + \frac{1.2Vh}{E_v A} \quad (\text{eq 7-8})$$

Where:

Δ_b = The flexural deflection, inches.

Δ_v = The shear deformation, inches.

A = The horizontal cross sectional area of the wall element, in²

I = The horizontal cross sectional moment of inertia of the wall element in direction of bending, in⁴.

E_v = The shear modulus of masonry, psi.

$$= 0.4E_m$$

When the wall or pier element is fixed at the bottom only, creating a cantilever condition, the total deflection, is defined by the following equation:

$$\Delta_c = \Delta_b + \Delta_v = \frac{Vh^3}{3E_m I} + \frac{1.2 Vh}{E_v A} \quad (\text{eq 7-9})$$

The rigidity or stiffness of the shear wall, usually expressed as, k, is defined as the inverse of the total deflection of the wall as stated in the following equation:

$$k = \frac{1}{\Delta_b + \Delta_v} \quad (\text{eq 7-10})$$

In the case of a solid wall with no openings, the computations of deflection are quite simple. However, where the shear wall has openings for doors, windows, etc., the computations for deflection and rigidity are much more complex. Since an exact analysis which considers angular rotation of elements, rib shortening, etc., is not necessary, several short cut approximate methods, involving more or less valid assumptions, have been developed. Any simplified method of determining shear wall rigidity can give inconsistent or unsatisfactory results; therefore, a conservative approach and judgment must be used.

b. *Wall deflection charts.* The recommended approximate method of determining deflections and rigidities of shear wall elements, including walls with openings is the wall deflection charts given in figure 7-5. The charts are based upon equations 7-8 and 7-9. When openings are present, a solid wall is assumed and subtractions and additions of the rigidities of pier increments are done to determine the relative rigidity of the panel. By substituting “ $td^3/12$ ” for “I”, “td” for “A”, and “ $0.4E_m$ ” for “ E_v ” equations 7-8 and 7-9 can be simplified to equations 7-11 and 7-12, respectively, as follows:

$$\Delta_f = \frac{V}{E_m t} \left[\left[\frac{h}{d} \right]^3 + 3 \left[\frac{h}{d} \right] \right] \quad (\text{eq 7-11})$$

$$\Delta_c = \frac{V}{E_m t} \left[4 \left[\frac{h}{d} \right]^3 + 3 \left[\frac{h}{d} \right] \right] \quad (\text{eq 7-12})$$

Since only relative rigidity values are required, any value could be used for E_m , and t as long as walls with differing moduli of elasticity and thickness are not being compared. V could also be arbitrary, as long as it is consistently used throughout the comparative process. The charts in figure 7-5 are based on values of; V = 1,000,000 pounds, E_m = 1,350,000 psi, and t = 12 inches. Using these values, equations 7-11 and 7-12 can be simplified to equations 7-13 and 7-14, respectively, as follows:

$$\Delta_f = 0.0617 \left[\frac{h}{d} \right]^3 + 0.1852 \left[\frac{h}{d} \right] \quad (\text{eq 7-13})$$

$$\Delta_c = 0.2469 \left[\frac{h}{d} \right]^3 + 0.1852 \left[\frac{h}{d} \right] \quad (\text{eq 7-14})$$

The thickness value used assumes a solid 12” thick masonry wall which is not equal to the actual standard masonry unit thickness of 11.62” but suffices for the purposes of these equations. Curves 2 and 4 of figure

TM 5-809-3/NAVFAC DM-2.9/AFM 88-3, Chap. 3

7-5 provide a graphical solution for equations 7-13 (for fixed ended rectangular piers) and 7-14 (for cantilever rectangular piers), respectively. When walls of different moduli of elasticity, E_m , are being compared, the deflection values shall be multiplied by the ratio of $1.35 \times 10^6/E_m$. When walls of different actual thicknesses or equivalent thicknesses, t , are being compared, the deflection values shall be multiplied by the ratio of $12/t$. In corner pier curves (1 and 3) the corner pier moment of inertia, I , is assumed to be 1.5 times that of the rectangular pier. The equations for the corner piers are derived by the procedure given above (using equation 7-8 and 7-9) except that $(1.5)I$ is substituted for I in the bending term of the equations, and the correction factor of 1.2 in the shear term of the equations is replaced by 1.0, since the section can no longer be considered rectangular. These substitutions result in equations 7-15 (for a fixed ended corner pier) and equation 7-16 (for a cantilever corner pier) as follows:

$$\Delta_f = 0.0412 \left[\frac{h}{d} \right]^3 + 0.1543 \left[\frac{h}{d} \right] \quad (\text{eq 7-15})$$

$$\Delta_c = 0.1646 \left[\frac{h}{d} \right]^3 + 0.1543 \left[\frac{h}{d} \right] \quad (\text{eq 7-16})$$

For other values of I , the flexural portion of the deflection curves would be proportional. The deflections shown on the charts are reasonably accurate. The formulas written on the curves can be used to check the results. However, the charts will give no better results than the assumptions made in the shear wall analysis. For instance, the point of contraflexure of a vertical pier may not be in the center of the pier height. In some cases the point of contraflexure may be selected by judgment and an interpolation made between the cantilever and fixed conditions.

7-9. Design examples. The following design examples illustrate the procedure for determining the rigidity of a shear wall section with one opening and give the complete design of a shear wall with two openings.

a. Design example 1.

(1) Given:

- (a) 12-inch normal weight CMU
- (b) Wall height (h) = 12 feet
- (c) Wall length (d) = 20 feet
- (d) Reinforcement = #5 bars @ 24" o.c.
- (e) Type S mortar is used with:
 - $f'_m = 1350$ psi
 - $E_m = 1000f'_m = 1,350,000$ psi
 - $E_v = 0.4E_m = 540,000$ psi.

- (f) There is a 4-feet by 4-feet window opening centered in wall.

(2) *Problem.* Determine the rigidity of the wall.

(3) *Solution.* The procedure involves determining the rigidities or stiffnesses of each segment within the shear wall element. The method is based on the deflection charts of figure 7-5. In this method; the deflection of the solid wall is determined, the deflection of the horizontal strip of the wall containing all the openings is deducted from the solid wall deflection, and then the deflections of the piers within this opening strip are added to this modified wall deflection to obtain the total deflection of the actual wall with openings. The reciprocal of this deflection value becomes the relative rigidity of that wall. Note that the following solution is carried out, in some instances, to four significant figures. This was done for calculation purposes and does not imply that the deflections would actually be accurate to the degree of precision since the procedure used is only approximate with simplified assumptions made.

(a) A solid wall containing ABCD with no openings is assumed fixed at the bottom only (use rectangular pier cantilever curve #4 from figure 7-5). Note that the equivalent wall thickness for 12-inch CMU with grouted cells @ 24" o.c. from table 5-2 is 5.7 inches.

$$\text{Solid Wall: } \frac{h}{d} = \frac{12}{20} = 0.60$$

$$\Delta_{\text{Solid}} = 0.1644 \times \frac{12''}{5.7''} = 0.3461''$$

$$k_{\text{Solid}} = \frac{1}{\Delta_{\text{Solid}}} = \frac{1}{0.3461} = 2.89 \text{ (Stiffness of solid wall)}$$

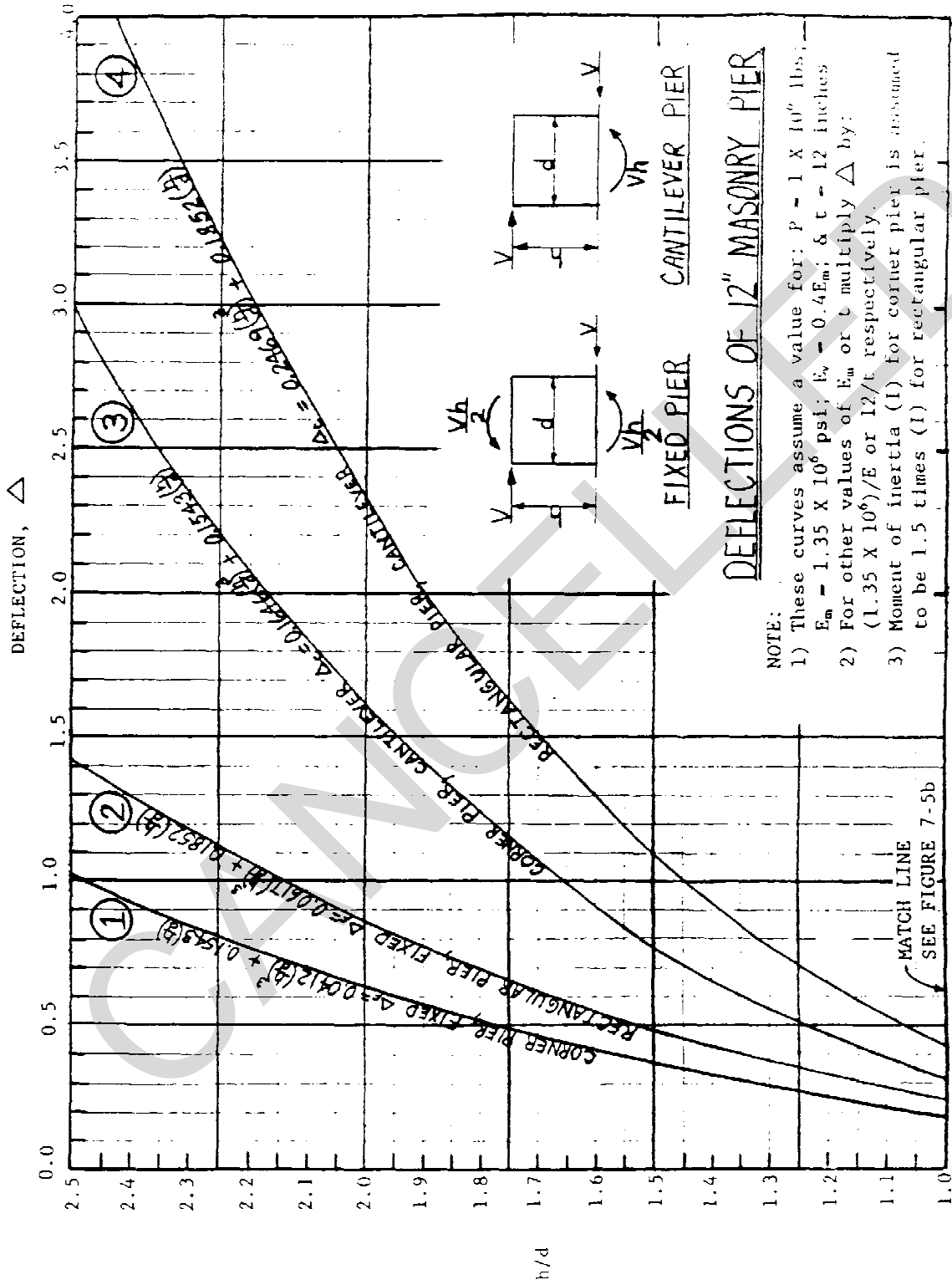

U. S. ARMY CORPS OF ENGINEERS

Figure 7-5a. Wall deflection chart.

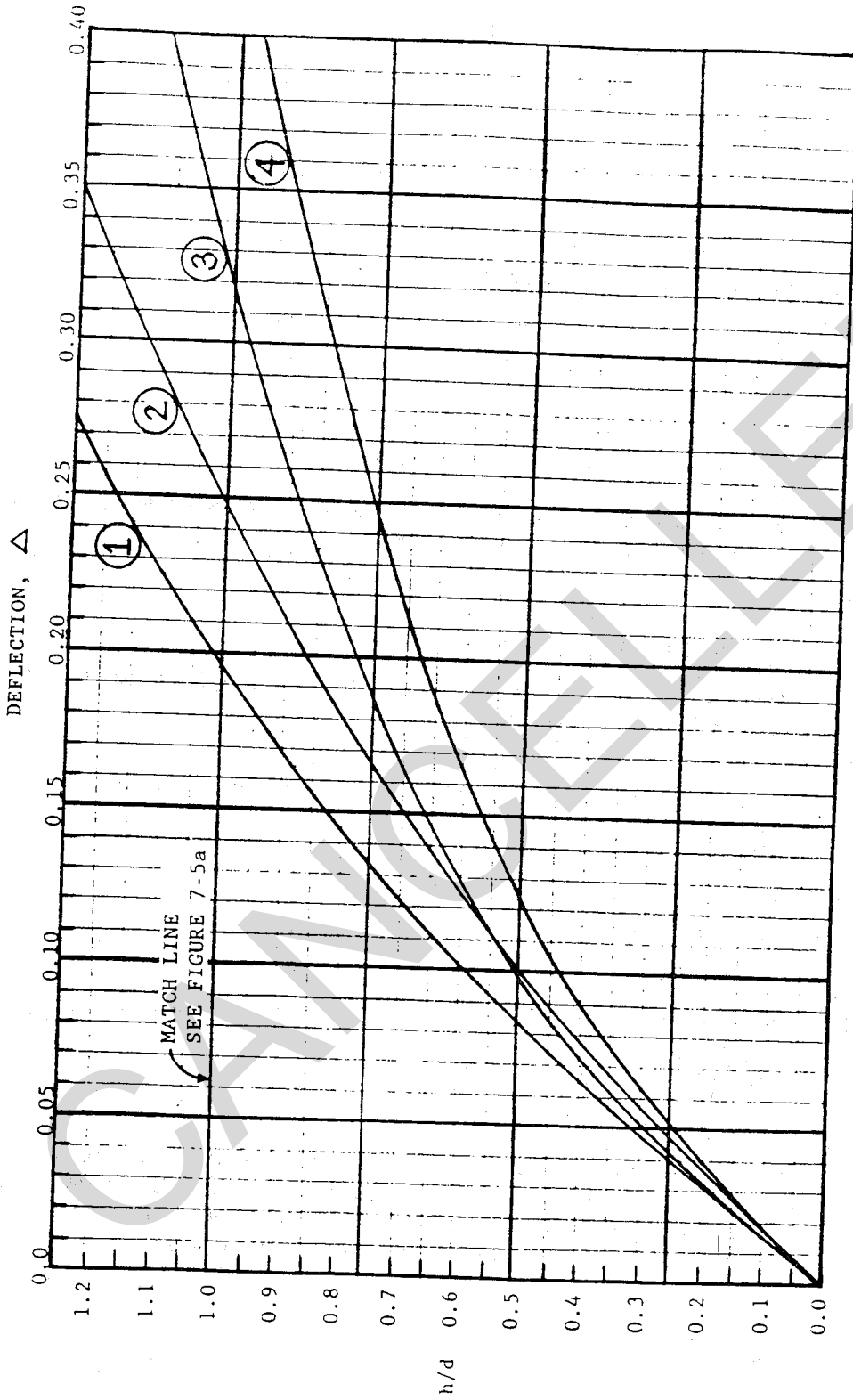

U. S. ARMY CORPS OF ENGINEERS

Figure 7-5b. Wall deflection chart.

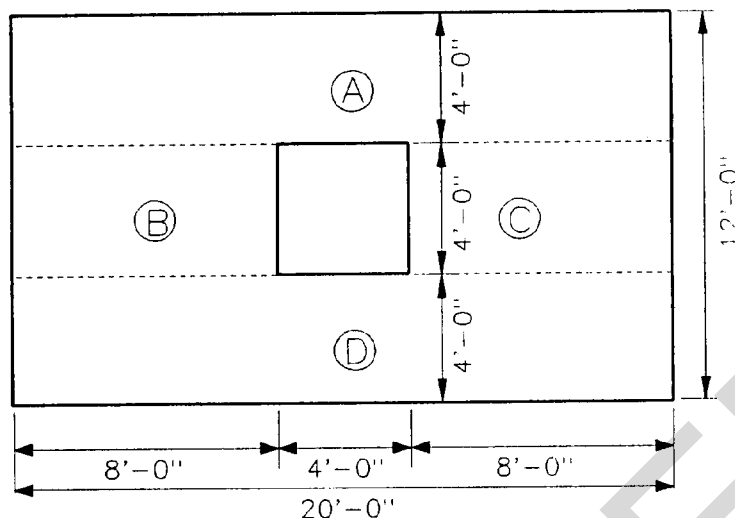

U. S. ARMY CORPS OF ENGINEERS

Figure 7-6. Design example 1 wall elevation.

(b) The deflection of the solid middle 4'-0" strip containing B and C is determined assuming it is a fixed pier (use rectangular pier fixed curve #2 from figure 7-5) as follows:

$$\frac{h}{d} = \frac{4}{20} = 0.20$$

$$\Delta_{\text{Solid}} = 0.03753'' \times \frac{12''}{5.7''} = 0.0790''$$

(c) The individual deflections of piers B and C are determined assuming fixed top and bottom (use rectangular pier fixed curve #2 from figure 7-5) as follows:

$$\text{Pier B \& C: } \frac{h}{d} = \frac{4}{8} = 0.50$$

$$\Delta_B = \Delta_C = 0.10'' \times \frac{12''}{5.7''} = 0.211''$$

$$k_B = k_C = \frac{1}{0.211} = 4.739$$

$$k_{BC} = k_B + k_C = 4.739 + 4.739 = 9.478$$

$$\Delta_{BC} = \frac{1}{k_{BC}} = \frac{1}{9.478} = 0.1055''$$

(d) The total shear wall deflection and stiffness can now be found as follows:

$$\Delta_{\text{TOTAL}} = \Delta_{\text{Solid}} = \Delta_{\text{Strip}} = \Delta_{BC}$$

$$\Delta_{\text{TOTAL}} = 0.3461'' - 0.0790'' + 0.1055'' = 0.3726''$$

$$k_{\text{TOTAL}} = \frac{1}{\Delta_{\text{TOTAL}}} = \frac{1}{0.3726} = 2.68 < k_{\text{Solid}} = 2.88$$

... O.K.

(4) *Summary.* The design example solution provided above illustrates the recommended procedure for determining the relative rigidity of a masonry shear wall element. Note that the relative rigidity of this wall element with one opening is about 93% of the solid wall element rigidity. Thus, it can be concluded that the opening has not significantly reduced the rigidity of the shear wall.

b. *Design example 2.*

(1) Given:

- (a) 8-inch normal weight CMU
- (b) Wall height (h) = 12 feet
- (c) Wall length (d) = 20 feet
- (d) In-plane shear force from wind loading (V) = 10 kips
- (e) Axial loads (Concentrically applied):
 - Dead load = 300 pounds per foot
 - Live load = 600 pounds per foot

- (f) Reinforcement:
 #5 bars @ 24" o.c.
 $f_y = 60,000$ psi
 $E_s = 29,000,000$ psi
- (g) Modular ratio $(n) = E_s/E_m = 21.5$
- (h) Equivalent wall thickness = 4.1 inches (table 5-2).
- (i) Type S mortar is used with:
 $f'_m = 1350$ psi
 $E_m = 1000f'_m = 1,350,000$ psi
 $E_v = 0.4E_m = 540,000$ psi.
- (j) There is a door and a window opening as shown in figure 7-7.

(2) *Problem.* Design the given shear wall to withstand the shear and axial forces applied.

(3) *Solution.* The design procedure involves determining the rigidities of each segment (pier) within the shear wall. The method used is based on the deflection charts of figure 7-5. The horizontal loading is then proportioned to each segment based on its rigidity relative to the other segments, with longer and shorter segments receiving the greater load. Each wall segment will then be analyzed by checking the flexural, axial, and shear stresses.

(a) The first step in designing the shear wall is to determine the relative rigidities or stiffnesses of the shear wall segments. The method used in determining the relative rigidities is similar to the procedure followed in design example 1.

A solid wall containing ABCDE with no openings is assumed fixed at the bottom only. The deflection and rigidity are determined (use rectangular pier cantilever curve #4 from figure 7-5) as follows:

Solid Wall: $\frac{h}{d} = \frac{12}{20} = 0.60$

$\Delta_{\text{Solid}} = 0.165'' \times \frac{12''}{4.1''} = 0.4829''$

$k_{\text{Solid}} = \frac{1}{\Delta_{\text{Solid}}} = \frac{1}{0.4829} = 2.07$ (Stiffness of solid wall)

The deflection of the solid bottom strip, 7.33 feet high, containing BCDE is determined (use rectangular pier cantilever curve #4 from figure 7-5) as follows:

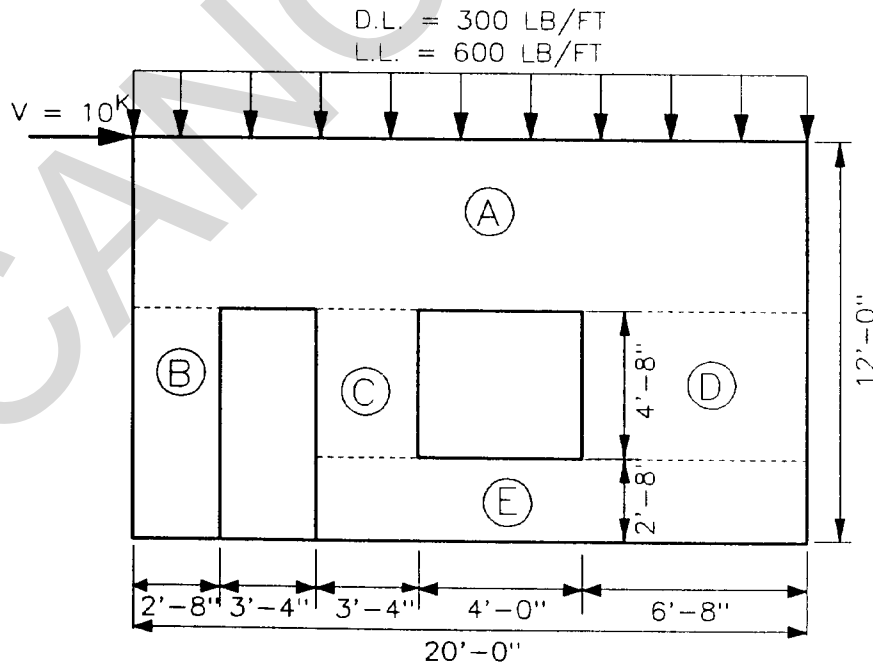

U. S. ARMY CORPS OF ENGINEERS

Figure 7-7. Design example 2 wall elevation.

$$\frac{h}{d} = \frac{7.33}{20} = 0.367$$

$$\Delta_{\text{Strip}} = 0.08'' \times \frac{12''}{4.1''} = 0.2341''$$

The combined deflection of piers B, C, D, and E are determined from the summation of their own individual rigidities (use rectangular pier fixed curve #2 from figure 7-5) as follows:

$$\text{Pier B: } \frac{h}{d} = \frac{7.33}{2.67} = 2.75$$

$$\Delta_B = 1.79'' \times \frac{12''}{4.1''} = 5.239''$$

$$k_B = \frac{1}{5.239} = 0.191$$

$$\text{Pier C: } \frac{h}{d} = \frac{4.67}{3.33} = 1.40$$

$$\Delta_C = 0.43'' \times \frac{12''}{4.1''} = 1.259''$$

$$k_C = \frac{1}{1.259} = 0.794$$

$$\text{Pier D: } \frac{h}{d} = \frac{4.67}{6.67} = 0.70$$

$$\Delta_D = 0.15'' \times \frac{12''}{4.1''} = 0.439''$$

$$k_D = \frac{1}{0.439} = 2.278$$

$$k_{CD} = k_C + k_D = 0.794 + 2.278 = 3.072$$

$$\Delta_{CD} = \frac{1}{k_{CD}} = \frac{1}{3.072} = 0.3255''$$

$$\text{Pier E: } \frac{h}{d} = \frac{2.67}{14.0} = 0.19$$

$$\Delta_E = 0.036'' \times \frac{12''}{4.1''} = 0.1054''$$

$$\Delta_{CDE} = \Delta_{CD} + \Delta_E = 0.3255 + 0.1054 = 0.4309''$$

$$k_{CDE} = \frac{1}{\Delta_{CDE}} = \frac{1}{0.4309} = 2.321$$

$$k_{BCDE} = k_B + k_{CDE} = 0.191 + 2.321 = 2.512$$

$$\Delta_{BCDE} = \frac{1}{k_{BCDE}} = \frac{1}{2.512} = 0.3981''$$

The total shear wall deflection and stiffness can now be found as follows:

$$\Delta_{\text{TOTAL}} = \Delta_{\text{Solid}} - \Delta_{\text{Strip}} + \Delta_{\text{BCDE}} = 0.4829'' - 0.2341'' + 0.3981'' = 0.6469''$$

$$k_{\text{TOTAL}} = \frac{1}{\Delta_{\text{TOTAL}}} = \frac{1}{0.6469} = 1.55 < k_{\text{Solid}} = 2.07$$

(b) The next step in the design is to determine the force distribution to the individual piers B, C, and D. This can be done by dividing the stiffness of the individual piers by the summation of stiffnesses of all the piers as follows: . . . O.K.

$$\text{Percentage of force to each pier} = \frac{k}{\Sigma k}$$

$$\text{To Pier B: } \frac{k_B}{k_{BCDE}} = \frac{0.191}{2.512} = 0.076 = 7.6\%$$

$$\text{To Piers CDE: } \frac{k_{CDE}}{k_{BCDE}} = \frac{2.321}{2.512} = 0.924 = 92.4\%$$

TM 5-809-3/NAVFAC DM-2.9/AFM 88-3, Chap. 3

Thus 7.6% of the total in-plane shear force on the wall will be resisted by Pier B and 92.4% of the force will be resisted by piers C and D. The 92.4% will be distributed to piers C and D in proportion to their relative rigidities as follows:

$$\text{Pier C: } \frac{k_C}{k_{CD}} = \frac{0.794}{3.072} = 0.26 \times .924 = .24 = 24\%$$

$$\text{Pier D: } \frac{k_D}{k_{CD}} = \frac{2.278}{3.072} = 0.74 \times .924 = .684 = 68.4\%$$

Therefore, 24% of the total shear force on the wall will be distributed to Pier C; 68.4% to Pier D; and 7.6% to Pier B.

(c) Now that the distribution of in-plane shear forces to each pier is known, the design of the piers can now be accomplished. The design of each pier will begin by checking the shear and flexural stresses due to in-plane wind loads. Axial stresses due to dead and live loads will also be checked. The flexural and axial stresses will then be combined using the unity equation. For loading combinations that include wind loads, the allowable stresses will be increased 33%.

Pier B design. The design for out-of-plane wind loadings (not part of this example) require that all cells be reinforced and fully grouted, thus the cross section of the pier is 2'-8" by 7.62" with #5 bars in each cell. When checking in-plane shear stresses, the assumed length of the pier, d_{Bv} , will be the actual pier length or 2'-8". When checking in-plane flexural stresses, the assumed effective depth of the beam section, d_{Bb} , will be the actual length less the 8-inch distance from the centroid of the two end bars to the end of the pier; therefore $d_{Bb} = 2'-0"$.

Shear Check

Lateral force, V_B , to Pier B = 7.6% of 10k

$$V_B = 0.076 \times 10k = 760 \text{ lbs.}$$

Shear stress in pier B, f_{vB} , is determined as follows:

$$f_{vB} = \frac{V_B}{td_{Bv}} = \frac{760 \text{ lbs.}}{7.62" \times 32"} = 3.1 \text{ psi}$$

The allowable shear stress assuming no shear reinforcement, F_{vm} , will be determined by equation 7-2 as follows (assume pier fixed top and bottom):

$$\frac{M}{Vd_{Bv}} = \frac{h}{2d_{Bv}} = \frac{7.33' \times 12"/2}{2 \times 32"} = 1.38 > 1.0$$

Therefore;

$$F_{vm} = 1.0(f'_m)^{1/2} = (1350)^{1/2} = 36.7 \text{ psi.}$$

But shall not exceed 35 psi; thus $F_{vm} = 35 \text{ psi}$.

$$f_{vB} = 3.1 \text{ psi} < F_{vm} = 35 \text{ psi} \times 1.33 = 46.5 \text{ psi;}$$

Therefore, no shear reinforcement is required.

Flexural Check. Both flexural compression and tension must be considered.

Flexural compressive stress in Pier B, f_{bB} , is determined as follows:

$$f_{bB} = \frac{2M}{bd_{Bb}^2jk}$$

Where:

$$M = \frac{v_B h}{2} = \frac{760 \text{ lb} \times 7.33' \times 12"/2}{2} = 33,440 \text{ in-lb}$$

$$b = 7.62"$$

$$A_s = 0.62 \text{ in}^2 \text{ (2 \#5's)}$$

$$p = \frac{A_s}{bd_{Bb}} = \frac{0.62 \text{ in}^2}{7.62" \times 24"} = 0.00344$$

$$np = 21.5 (0.0034) = 0.073; \text{ thus } k = 0.316 \text{ and } j = 0.895$$

$$f_{bB} = \frac{2 \times 33,440}{7.62(24)^2(0.895)(0.316)} = 53.9 \text{ psi}$$

Allowable flexural compressive stress in Pier B, F_b , is determined as follows:

$$F_b = 0.33f'_m \times 1.33 = 0.33(1350) \times 1.33 = 600 \text{ psi}$$

$$F_{bB} = 53.9 \text{ psi} < f_b = 600 \text{ psi}$$

...O.K.

Flexural tensile stress in Pier B, f_{sB} , is determined as follows:

$$f_{sB} = \frac{M}{A_s j d_{Bb}} = \frac{33,440}{(0.62)(0.895)(24)} = 2511 \text{ psi}$$

Allowable flexural tensile stress in Pier B, F_s , is determined as follows:

$$F_s = 24,000 \times 1.33 = 32,000 \text{ psi (Grade 60 steel)}$$

$$f_{sB} = 2511 \text{ psi} < F_s = 32,000 \text{ psi}$$

...O.K.

Axial Load Check. Since the maximum moment occurs at the top or the bottom of the pier and the axial load is maximum at the bottom of the pier, the axial load will be determined at the bottom of the pier. The fully grouted weight of the wall, w_2 , is 92 psf.

Axial load at the bottom of Pier B, P , is determined as follows:

$$P_{\text{TOTAL}} = P_{\text{DL}} + P_{\text{LL}} + \text{Wall Wt. to bottom of Pier B}$$

$$P_{\text{TOTAL}} = [(300 \text{ lb/ft}) + (600 \text{ lb/ft})] (4.33 \text{ ft})$$

$$+ 92 \text{ psf} [(7.33') (2.67') + (4.67') (4.33')]$$

$$= 3900 + 3611 = 7561 \text{ lbs.}$$

Axial stress due to axial load in Pier B, f_{aB} , is determined as follows:

$$f_{aB} = \frac{P}{A} = \frac{7561 \text{ lbs.}}{7.62'' \times 32''} = 31.0 \text{ psi}$$

Allowable axial stress in Pier B, F_a , is determined as follows:

$$F_a = (0.2 f'_m) R$$

Where:

R = The stress reduction factor.

Since buckling is not a concern at the bottom of the pier, R will be omitted and including wind loading:

$$F_a = (0.2 f'_m) \times 1.33$$

$$= 0.2 (1350) \times 1.33 = 360 \text{ psi}$$

$$f_{aB} = 31.0 \text{ psi} < F_a = 360 \text{ psi}$$

...O.K.

Axial stress on Pier B due to the overturning moment of the entire wall panel, f_{oB} , is determined as follows:

$$f_{oB} = M_o C_B / I_n$$

Where:

M_o = The overturning moment, ft-lbs.
 $= Vh = 10,000 \text{ lb.} \times 12.0' = 120,000 \text{ ft-lb.}$

C_B = Distance from the center of gravity of the net wall section to the centroid of the pier in question (Pier B). See table 7-1.

I_n = Moment of inertia of the net wall section

$I_n = \Sigma(I_{\text{Cen}} + AC^2) = \Sigma AC^2$ (Because I_{Cen} , which is equal to $bd^3/12$, is usually negligible compared to AC^2 . Therefore, use $I_n = \Sigma AC^2$. See table 7-1.)

From table 7-1, C_B and I_n are determined and the axial stress on pier B due to overturning, f_{oB} , is determined as follows:

$$f_{oB} = \frac{120,000 \text{ ft-lb.} \times 7.94 \text{ ft}}{237.42 \text{ ft}^4 \times 144 \text{ in}^2/\text{ft}^2} = 27.9 \text{ psi}$$

$$f_{oB} = 27.9 \text{ psi} < F_a = 360 \text{ psi}$$

...O.K.

Combined Load Check. The combined effects of flexural, axial, and overturning on pier B can be evaluated using the unity equation as follows:

$$\frac{f_{bB}}{f_b} + \frac{f_{aB}}{F_a} + \frac{f_{oB}}{F_a} \leq 1.0$$

$$\frac{53.9}{600} + \frac{31.0}{360} + \frac{27.9}{360} = 0.25 < 1.0$$

...O.K.

Pier C design. The design for out-of-plane wind loadings (not part of this example) require that all cells be reinforced and fully grouted, thus the cross section of the pier is 3'-4" by 7.62" with 5 bars in each cell. When checking in-plane shear stresses, the assumed length of the pier, d_{Cv} , will be the actual pier length or 3'-4". When checking in-plane flexural stresses, the assumed effective depth of the beam section, d_{Cb} , will be the

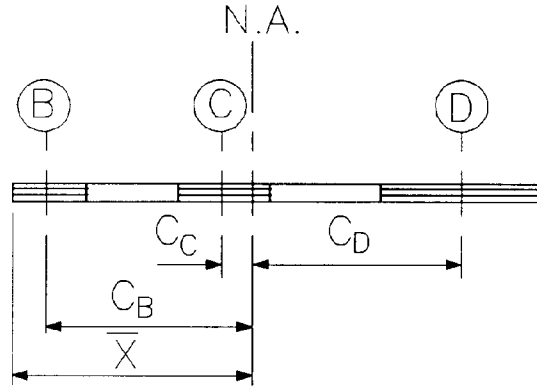

PIER	AREA (ft ²)	X (ft)	AX (ft ³)	C (ft)	AC ² (ft ⁴)
B	1.70	1.33	2.26	7.53	96.39
C	2.11	7.67	16.18	1.19	2.99
D	2.05	16.33	33.48	7.47	114.39
	Σ 5.86		Σ 51.92		Σ 213.77

$$\bar{X} = \frac{51.92 \text{ ft}^3}{5.86 \text{ ft}^2} = 8.86 \text{ ft} \quad I_n = \Sigma AC^2 = 213.77 \text{ ft}^4$$

Note: The area of Pier D is based on an equivalent solid thickness of 4.1 inches for a wall section with grouted cells at 24 inches on center. Pier B and C are grouted full and have a thickness of 7.62 inches.

U. S. ARMY CORPS OF ENGINEERS

Table 7-1. Centroid and moment of inertia of net wall section.

actual length less the 8-inch distance from the centroid of the two end bars to the end of the pier; so $d_{cB} = 2'-8''$.

Shear Load

Lateral force, V_c , to Pier C = 24% of 10k

$$V_c = 0.24 \times 10k = 2400 \text{ lbs.}$$

Shear stress in pier C, f_{vC} , is determined as follows:

$$f_{vC} = \frac{V_c}{td_{Cv}} = \frac{2400 \text{ lbs}}{7.62'' \times 40''} = 7.9 \text{ psi}$$

The allowable shear stress, F_{vm} , will be determined by equation 7-1 as follows (assume pier fixed top and bottom):

$$\frac{M}{Vd_{Cv}} = \frac{h}{2d_{Cv}} = \frac{4.67' \times 12''/}{2 \times 40''} = 0.70 < 1.0$$

Therefore;

$$F_{vm} = \frac{1}{3} \left[4 - \frac{M}{Vd} \right] (f'_m)^{1/2}$$

$$= \frac{1}{3} [4 - 0.70] (1350)^{1/2} = 40.4 \text{ psi}$$

But shall not exceed: $80 - 45[M/(Vd_{Cv})]$

$$F_{vm} = 80 - 45(0.70) = 48.5 \text{ psi; thus } F_{vm} = 40.4 \text{ psi}$$

$$f_{vC} = 7.9 \text{ psi} < F_{vm} = 40.4 \text{ psi} \times 1.33 = 53.7 \text{ psi}$$

Therefore; no shear reinforcement is required.

Flexural Check. Both flexural compression and tension must be considered.

Flexural compressive stress in Pier C, f_{bc} , is determined as follows:

$$f_{bc} = \frac{2M}{bd_{cb}^2jk}$$

Where:

$$M = \frac{V_c h}{2} = \frac{2400 \text{ lb} \times 4.67' \times 12''/\text{ft}}{2} = 67,248 \text{ in-lb}$$

$$b = 7.62''$$

$$A_s = 0.62 \text{ in}^2 \text{ (2 = \#5's)}$$

$$p = \frac{A_s}{bd_{cb}} = \frac{0.62 \text{ in}^2}{7.62'' \times 32''} = 0.0025$$

$$np = 21.5(0.0025) = 0.054; \text{ thus } k = 0.28 \text{ and } j = 0.907$$

$$f_{bc} = \frac{2 \times 67,248}{7.62(32)2(0.907)(0.28)} = 67.9 \text{ psi}$$

$$f_{bc} = 67.9 \text{ psi} < F_b = 600 \text{ psi}$$

... O.K.

Flexural tensile stress in Pier C, f_{sc} , is determined as follows:

$$f_{sc} = \frac{M}{A_s j d} = \frac{67,248}{(0.62)(0.907)(32)} = 3737 \text{ psi}$$

$$f_{sc} = 3737 \text{ psi} < F_s = 32,000 \text{ psi}$$

...O.K.

Axial Load Check. Since the maximum moment occurs at the top or the bottom of the pier and the axial load is maximum at the bottom of the pier, the axial load will be determined at the bottom of the pier. The fully grouted weight of the wall, w_2 , is 92psf.

Axial load at the bottom of Pier C = P (lbs.)

$$P_{\text{TOTAL}} = P_{\text{DL}} + P_{\text{LL}} + \text{Wall wt. to bottom of Pier C}$$

$$P_{\text{TOTAL}} = [(300 \text{ lb/ft}) + (600 \text{ lb/ft})] (7.0 \text{ ft}) + 92 \text{ psf}[(4.67)(3.33') + (4.67')(7.0')] = 6300 + 4438 = 10,738 \text{ lbs.}$$

Axial stress due to axial load in Pier C, f_{ac} determined as follows:

$$f_{ac} = \frac{P}{A} = \frac{10,738 \text{ lbs.}}{7.62'' \times 40''} = 35.2 \text{ psi}$$

Allowable axial stress in Pier C, F_a , is determined as follows:

$$F_a = (0.2 f'_m)R$$

Where:

R = The stress reduction factor.

Since buckling is not a concern at the bottom of the pier, R will be omitted and including wind loading:

$$F_a = 0.2 f'_m \times 1.33 = 0.2 (1350) \times 1.33 = 360 \text{ psi}$$

$$f_{ac} = 35.2 \text{ psi} < F_a = 360 \text{ psi}$$

...O.K.

Axial stress in Pier C due to the overturning moment of the entire wall panel, f_{oc} , is determined as follows:

$$f_{oc} = \frac{M_o C_c}{I_n}$$

Where:

$$M_o = \text{Overturning Moment} = Vh = 10,000 \text{ lbs.} \times 12.0' = 120,000 \text{ ft-lb.}$$

C_c = Distance from the center of gravity of the net wall section to the centroid of the pier in questions (Pier C). See table 7-1.

I_n = Moment of inertia of the net wall section = $\Sigma(I_{\text{Cen}} + AC^2) \approx \Sigma AC^2$ (Because I_{Cen} , which is equal to $bd^3/12$, is usually negligible compared to AC^2 . Therefore, use $I_n = \Sigma AC^2$. See table 7-1.)

TM 5-809-3/NAVFAC DM-2.9/AFM 88-3, Chap. 3

$$F_{oC} = \frac{120,000 \text{ ft-lb.} \times 1.60 \text{ ft}}{237.42 \text{ ft}^4 \times 144 \text{ in}^2/\text{ft}^2} = 5.6 \text{ psi}$$

$$f_{oC} = 5.6 \text{ psi} < F_a = 360 \text{ psi}$$

...O.K.

Combined Load Check. The combined effects of flexural, axial, and overturning of pier C can be evaluated using the unity equation as follows:

$$\frac{67.9}{600} + \frac{35.2}{360} + \frac{5.6}{360} = 0.23 < 1.0$$

...O.K.

Pier D design. The pier is reinforced with #5 bars at 24 inches o.c., so the equivalent solid wall thickness is 4.1". The cross section of the pier is 6'-8" by 4.1" and the area assumed effective in shear parallel to the wall face, A_{eff} , is 49.0 in²/ft. The design of pier D will follow the same procedure as previously shown for piers B and C except for the conditions stated herein. The resulting design stress values are as follows:

Shear Load.

Lateral force to Pier D, V_D , is 68.4% of 10k:

$$V_D = 0.684 \times 10k = 6840 \text{ lbs.}$$

Shear stress in pier D, f_{vD} , is determined as follows:

$$f_{vD} = \frac{V_D}{A_{eff}} = \frac{6840 \text{ lbs.}}{49 \text{ in}^2/\text{ft} \times 6.67 \text{ ft}} = 20.9 \text{ psi}$$

The allowable shear stress, F_{vm} , will be determined by equation 7-1 as follows (assume pier fixed top and bottom):

$$\frac{M}{Vd_{DV}} = \frac{h}{2d_{Dv}} = \frac{4.67' \times 12''/\text{ft}}{2 \times 80''} = 0.35 < 1.0$$

Therefore;

$$F_{vm} = \frac{1}{3} \left[4 - \frac{M}{Vd} \right] (f'_m)^{1/2} \\ = \frac{1}{3} [4 - 0.35] (1350)^{1/2} = 44.7 \text{ psi}$$

But shall not exceed: 80 - 45 $[M/(Vd_{CV})]$

$$F_{vm} = 80 - 45(0.35) = 64.3 \text{ psi}; \text{ thus } F_{vm} = 44.7 \text{ psi}$$

$$f_{vD} = 20.9 \text{ psi} < F_{vm} = 44.7 \text{ psi} \times 1.33 = 59.5 \text{ psi}$$

Therefore, no shear reinforcement is required.

Flexural Check:

Flexural compressive stress in Pier D, f_{bD} , is determined as follows:

$$f_{bD} = \frac{2M}{bd_b^2 jk}$$

Where:

$$M = \frac{v_D h}{2} = \frac{6840 \text{ lb} \times 4.67' \times 12''/\text{ft}}{2} = 191,657 \text{ in-lb}$$

$$b = 4.1''; d = 80'' - 8'' = 72''$$

$$A_s = 0.62 \text{ in}^2 \text{ (2 - \#5's)}$$

$$p = \frac{A_s}{bd} = \frac{0.62 \text{ in}^2}{4.1'' \times 72''} = 0.0021$$

$$np = 21.5(0.0021) = 0.05; \text{ thus } k = 0.27 \text{ and } j = 0.91$$

$$f_{bD} = \frac{2 \times 191,657}{4.1(72)2(0.91)(0.27)} = 73.4 \text{ psi}$$

$$f_{bD} = 73.4 \text{ psi} < f_b = 600 \text{ psi}$$

...O.K.

Flexural tensile stress in Pier D, f_{sD} , is determined as follows:

$$f_{sD} = \frac{M}{A_s j d} = \frac{191,657}{(0.62)(0.91)(72)} = 4718 \text{ psi}$$

...O.K.

Axial Load Check: The weight of the wall, grouted at 24 inches on center, w_2 , is 69 psf.

Axial load at the bottom of Pier D, P , is determined as follows:

$$P_{\text{TOTAL}} = [(300 \text{ lb/ft}) + 600 \text{ lb/ft}] (8.67 \text{ ft}) \\ + 69 \text{ psf} [(4.67') (6.67') + (4.67') (8.67')] \\ = 7803 + 4943 = 12,746 \text{ lbs.}$$

Axial stress due to axial load in Pier D, f_{aD} , is determined as follows:

$$f_{aD} = \frac{P}{A} = \frac{12,746 \text{ lbs.}}{4.1'' \times 80''} = 38.9 \text{ psi}$$

$$f_{aD} = 38.9 \text{ psi} < F^a = 360 \text{ psi (See Pier B for } F_a)$$

...O.K.

Axial stress in Pier D stress due to the overturning of the entire wall panel, is determined as follows:
(See Pier B design):

$$f_{oD} = \frac{M_o C_D}{I_n} = \frac{120,000 \text{ ft-lb.} \times 7.40 \text{ ft}}{237.42 \text{ ft}^4 \times 144 \text{ in}^2/\text{ft}^2} = 26.0 \text{ psi}$$

$$f_{oD} = 26.0 \text{ psi} < F_a = 360 \text{ psi}$$

...O.K.

Combined Load Check: (Use the unity equation, see Pier B design.)

$$\frac{73.4}{600} + \frac{38.9}{360} + \frac{26.0}{360} = 0.30 < 1.0$$

...O.K.

(4) *Summary.* The design example solution provided above has shown that the assumed wall section is adequate to withstand the applied axial and in-plane shear loads.

CHAPTER 8

LINTELS

8-1. Introduction. A lintel is a horizontal beam supporting loads over an opening. This chapter covers the design of reinforced masonry lintels. Reinforced masonry lintels must have all cores and other voids solidly grouted. Precast reinforced concrete or structural steel lintels will be designed in accordance with ACI 318 and the AISC Steel Construction Manual, respectively, except the deflection limits contained in this chapter will be followed. Torsion is not covered in this chapter. Where torsion is a major consideration, the designer should consider precast reinforced concrete lintels with closed loop stirrups. The principles of this chapter may be used for designing beams of reinforced masonry that are not lintels. Except as contained herein, design criteria, section properties, material properties, design equations, and allowable stresses are contained in chapter 5.

8-2. Loading. In addition to its own weight, a lintel may carry distributed loads from above, both from the wall weight and from floor or roof framing. The lintel may also carry concentrated loads from the framing members above.

a. Distributed loads. The shape of the loading diagram for the distributed loads to the lintel depends upon whether arching action of the masonry above the opening can be assumed. When arching action occurs, the lintel supports only the masonry that is contained within a triangle having sides which begin at the ends of the lintel and slope upward and inward 45 degrees from the horizontal to converge at an apex above the center of the lintel. See figure 8-1 for an illustration of this triangular lintel loading distribution. When the lintel deflects into the opening over which it spans, the masonry above the triangle will arch over the lintel and be supported by the more rigid walls on either side of the opening. For the arch to be stable, both ends of the opening must have sufficient horizontal restraint to provide the confining thrust necessary to support it laterally. Therefore, arching action should not be considered where the end of the arch and the lintel are near a wall corner, near a control or building expansion joint, or in stacked bond walls. When arching action can be assumed, the lintel will be designed to carry its own weight plus the weight of masonry within the triangle above. Where uniform floor or roof loads are applied to the wall above the apex of the triangle, it will be assumed that arching action will carry these loads around the opening and not load the lintel. When uniform floor or roof loads are applied below the apex of the triangle, arching action cannot take place and these loads will be carried downward and applied uniformly on the lintel. Also, when a uniform floor or roof load is applied below the apex of the triangle, it will be assumed that all of the weight of the masonry above the lintel is uniformly supported by the lintel.

b. Concentrated loads. Concentrated loads from beams, girders, or trusses framing into the masonry wall above an opening will be distributed downward from the apex of a triangle which is located at the point of load application. The sides of this triangle make an angle of 60 degrees with the horizontal. The load is transferred as a uniform load over the base of the triangle. This uniform load may extend over only a portion of the lintel. See figure 8-1 for an illustration of the distribution of concentrated loads on lintels.

8-3. Allowable deflection. For all lintels, the total deflection will be limited to $L/600$, not to exceed 0.3 inches.

8-4. Masonry lintel deflections.

a. Deflection parameters. When calculating lintel deflections the following parameters will be used.

(1) Span length. The assumed span for deflection calculations will be the distance between the centers of supports, illustrated as dimension "L" on figure 8-1.

(2) Moment of Inertia. The moment of inertia for deflections will be the effective moment of inertia, I_e , which will be determined as follows:

$$I_e = (M_{cr}/M_{max})^3 I_g + [1 - (M_{cr}/M_{max})^3] I_{cr} \quad (\text{in}^4) \quad (\text{eq 8-1})$$

Where:

M_{max} = The maximum moment in the member at the design load level, inch-pounds.

M_{cr} = The moment that causes flexural cracking of the lintel section, given in equation 8-2, inch-pounds.

$$M_{cr} = \frac{f_r I_g}{Y_t} \quad (\text{eq 8-2})$$

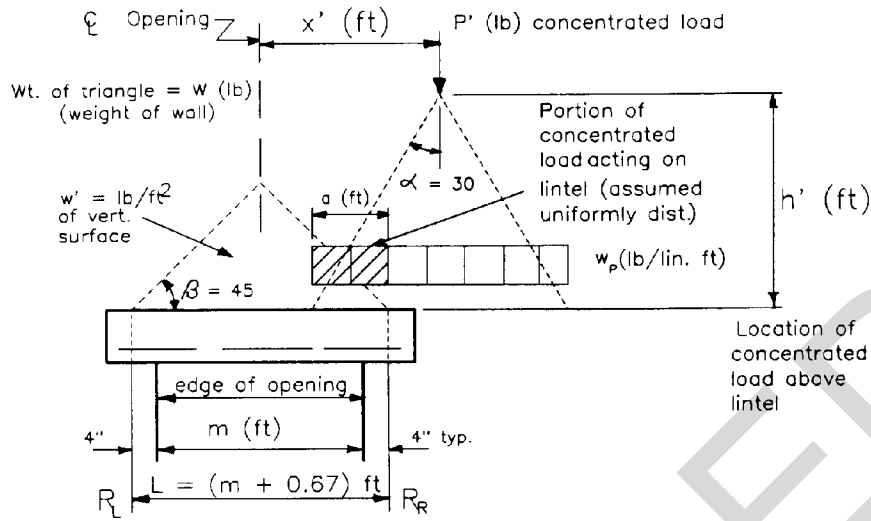

U. S. ARMY CORPS OF ENGINEERS

Figure 8-1. Triangular and Concentrated loadings on lintels.

Where:

f_r = The modulus of rupture, which is provided in chapter 5.

Y_t = The distance from the compression face to the neutral axis of the lintel, inches.

I_g = The moment of inertia of the uncracked lintel cross section about the centroid, in⁴.

$$I_g = \frac{b(h^3)}{12}$$

b = The actual width of the lintel, inches.

h = The total depth of the lintel, in.

I_{cr} = The moment of inertia of the cracked section of the lintel, in⁴.

$$I_{cr} = \frac{b(kd)^3}{3} + nA_s(d - kd)^2 \text{ (in}^4\text{)} \tag{eq 8-3}$$

Values of I_{cr} for most masonry lintels are provided in the tables in appendix B. For continuous members, the effective moment of inertia may be taken as the average of values obtained from equation 8-1 for the critical positive and negative moment sections. It will not be assumed greater than I_g .

b. Total deflection (long term). For masonry lintels, the total deflection, Δ_{mt} , will be the deflection due to short term loadings, Δ_{ms} , (such as live loading and transient dead loadings) combined with the deflections due to long term dead loadings, Δ_{ml} , as follows:

$$\Delta_{mt} = \Delta_{ms} + (3)(\Delta_{ml}) \text{ (inches)} \tag{eq 8-4}$$

8-5. Bearings pressure at lintel reaction. The minimum bearing length will be eight inches. The minimum bearing area, A_{brg} , will be:

$$A_{brg} = 8b \text{ (in}^2\text{)} \tag{eq 8-5}$$

Fully grouted cores are required below the lintel bearing area. It is reasonable to assume a triangular stress distribution when determining the maximum bearing stress, f_{brg} . When this assumption is made, the maximum bearing stress occurs at the face of the support and is determined by the following equation:

$$f_{brg} = \frac{(2)(R_{brg})}{A_{brg}} \text{ (psi)} \tag{eq 8-6}$$

Where:

R_{brg} = The end reaction of the lintel, lbs.

The maximum bearing stress will not exceed the allowable bearing stress, which is given in chapter 5. If the lintel is restrained against rotation at the support, a uniform stress distribution will be assumed.

8-6. Lateral support. When the tops of lintels are at the tops of walls or when the provisions of this chapter are used to design concrete masonry beams other than lintels, the compression face of the lintel or beam must be given lateral support. The clear distance between points of lateral support of the compression face will not exceed 32 times the least width of the compression face.

8-7. Design aids. Appendix C provides design tables to aid the designer in designing masonry lintels.

8-8. Design examples.

a. *Design example 1.*

(1) *Given.*

- (a) 8-inch CMU nonloadbearing wall
- (b) Wall height = 12 feet
- (c) $f'_m = 1350$ psi
- (d) $F_m = 1/3f'_m = 450$ psi
- (e) $E_m = 1000f'_m = 1,350,000$ psi
- (f) Type S mortar
- (g) Reinforcement

$f_y = 60,000$ psi

$F_s = 24,000$ psi

$E_s = 29,000,000$ psi

(h) $n = \frac{E_s}{E_m} = \frac{29,000,000}{1,350,000} = 21.5$

(i) A door opening 3'-4" wide by 7'-4" high is located in the wall as shown in figure 8-2.

(2) *Problem.* Design the lintel over the door.

(3) *Solution.* Due to the location of the lintel within the wall panel, the confining end thrust necessary to provide arching action may be assumed. Therefore, the lintel must support its own weight plus the weight of the triangle of masonry above the door and below the arch. Assume an 8-inch by 8-inch CMU lintel.

Flexural Check

(a) Determine the maximum moment due to the loading, M_{max} , as follows:

$$M_{max} = \frac{wL^2}{8} + \frac{w'L^3}{24}$$

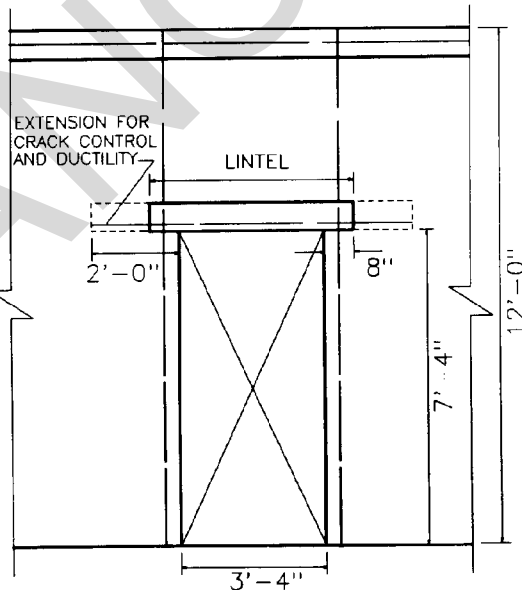

U. S. ARMY CORPS OF ENGINEERS

Figure 8-2. Example 1 wall elevation.

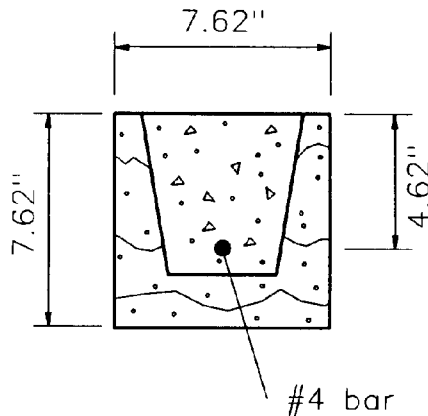

U. S. ARMY CORPS OF ENGINEERS

Figure 8-3. Example 1 lintel cross section.

Where:

w = The lintel weight = 62 lb/ft

w' = The unit weight of the masonry triangle (assume no reinforced filled cells) = 50 psf

$$M_{\max} = \frac{(62)(4.0)^2}{8} + \frac{(50)(4.0)^3}{24} = 257 \text{ ft-lb}$$

(b) Determine the area of reinforcement, A_{sb} , required to provide a balanced steel ratio, P_c .

$$A_{sb} = (P_c)(b)(d)$$

Where:

$P_c = 0.0027$ (See table 5-9)

b = The lintel width = 7.62 in

d = The effective depth of lintel = 4.62 in

$$A_{sb} = 0.0027(7.62)(4.62) = 0.095 \text{ in}^2$$

(c) The minimum reinforcement required above any wall opening is 1-#4 bar, $A_s = 0.20 \text{ in}^2$.

$A_s = 0.20 \text{ in}^2 > A_{sb} = 0.095 \text{ in}^2$ therefore; the design section (shown in figure 8-3) is over-reinforced and the compressive stress in masonry will control over the tensile stress in the reinforcement.

(d) The masonry resisting moment, M_{rm} , is determined as follows:

$$M_{rm} = \frac{F_m k j b d^2}{2(12)} \text{ ft-lb}$$

Where:

$$k = \left[(np)^2 + 2np \right]^{1/2} - np$$

And;

$$p = \frac{A_s}{bd} = \frac{0.20}{7.62 \times 4.62} = 0.00568$$

So;

$$k = \left[(21.5 \times 0.00568)^2 + 2(21.5 \times 0.00568) \right]^{1/2} - (21.5 \times 0.00568) = 0.387$$

$$j = 1 - k/3 = 1 - (0.387/3) = 0.871$$

$$M_{rm} = \frac{(450)(0.387)(0.871)(7.62)(4.62)^2}{2(12 \text{ in/ft})} = 1028 \text{ ft-lb}$$

$$M_{\max} = 257 \text{ ft-lb} < M_{rm} = 1028 \text{ ft-lb}$$

...Flexure O.K.

Deflection Check

(a) Determine the moment that causes flexural cracking of the lintel section, M_{cr} , as follows:

$$M_{cr} = \frac{f_r I_g}{Y_t} \text{ ft-lb}$$

Where:

$$f_r = 2.5\sqrt{f'_m} = 2.5\sqrt{1350} \text{ psi} = 91.8 \text{ psi}$$

$$I_g = (7.62)(7.62)^3/12 = 281 \text{ in}^4$$

$$Y_t = 7.62/2 = 3.81 \text{ in}$$

$$M_{cr} = \frac{(91.8)(281)}{3.81(12 \text{ in/ft})} = 564 \text{ ft-lb}$$

Since $M_{cr} > M_{max}$; the lintel is not cracked, therefore I_g is used in lieu of I_e .

(b) Since all the loadings are long term (dead load), the total lintel deflection, Δ_{mt} , is determined by modifying equation 8-4 as follows:

$$\begin{aligned} \Delta_{mt} &= (3)(\Delta_{ml}) \\ &= (3) \left[\frac{5wL^4}{384EI} + \frac{WL^3}{60EI} \right] \\ \Delta_{mt} &= (3) \left[\frac{5(62)(4.0)^4(1728 \text{ in}^3/\text{ft}^3)}{384(1,350,000)(281)} \right. \\ &\quad \left. + \frac{(200)(4.0)^3(1728 \text{ in}^3/\text{ft}^3)}{60(1,350,000)(281)} \right] = 0.0057 \text{ in} \end{aligned}$$

(c) Determine the allowable lintel deflection, Δ_{allow} , and compare to the maximum lintel deflection, $\Delta_{max} = 0.30 \text{ in}$, as follows:

$$\Delta_{allow} = \frac{L}{600} = \frac{(4)(12 \text{ in/ft})}{600} = 0.08 \text{ in}$$

$$\Delta_{allow} < \Delta_{max}; \text{ Use } \Delta_{allow} = 0.08 \text{ in}$$

$$\Delta_{allow} = 0.08 \text{ in} > \Delta_{mt} = 0.0057 \text{ in}$$

...Deflection O.K.

Shear Check

(a) Determine the shear loading, V , as follows:

$$V = \frac{wL}{2} + \frac{W}{2}$$

Where:

W = The weight of the triangular shaped wall segment, lbs.

$$= (50\text{psf})(4.0\text{ft})(2.0\text{ft})/2 = 200 \text{ lbs}$$

$$V = \frac{(62)(4.0)}{2} + \frac{200}{2} = 224 \text{ lb}$$

(b) Determine the shear stress in the lintel due to loading, as follows:

$$f_v = \frac{V_{max}}{bd} = \frac{224}{(7.62)(4.62)} = 6.36 \text{ psi}$$

(c) Determine the allowable shear stress, F_v , as follows:

$$F_v = F'_v = 1.0\sqrt{f'_m} = (1.0)\sqrt{1350} \text{ psi} = 36.7 \text{ psi}$$

$$F_v = 36.7 > f_v = 6.36 \text{ psi}$$

...Shear O.K.

Bearing Check

(a) Determine the maximum bearing stress, $f_{brg(max)}$, assuming a triangular stress distribution as follows:

$$f_{brg(max)} = \frac{V_{max}}{A_{brg}}$$

Where:

A_{brg} = The bearing area of the lintel, in^2

$$= 8 \text{ in} \times 7.62 \text{ in} = 61 \text{ in}^2$$

$$f_{brg(max)} = \frac{2(224)}{61} = 7.3 \text{ psi}$$

(b) Determine the allowable bearing stress, F_{brg} , as follows:

$$F_{brg} = 0.25(f'_m)$$

$$= 0.25(1.350) \text{ psi} = 338 \text{ psi}$$

$$F_{brg} = 338 \text{ psi} > f_{brg(max)} = 7.3 \text{ psi}$$

...Bearing O.K.

TM 5-809-3/NAVFAC DM-2.9/AFM 88-3, Chap. 3

(4) Summary: The 8-inch x 8-inch CMU lintel reinforced with 1-#4 bar is sufficient.

b. Design example 2.

(1) *Given.*

- (a) 8-inch CMU loadbearing wall
- (b) Wall height = 14 ft
- (c) Uniform dead load (w_{DL}) = 100 plf
- (d) Uniform live load (w_{LL}) = 250 plf
- (e) Concentrated live load (P') = 5000 lbs
- (f) $f'_m = 1350$ psi
- (g) $F'_m = 1/3f'_m = 450$ psi
- (h) $E_m = 1000f'_m = 1,350,000$
- (i) Type S mortar
- (j) Reinforcement:
 $f_y = 60,000$ psi
 $F_s = 24,000$ psi
 $E_s = 29,000,000$ psi

(k)
$$n = \frac{E_s}{E_m} = \frac{29,000,000}{1,350,000} = 21.5$$

- (l) A door 12 ft wide by 10 ft high is located in the wall as shown in figure 8-4.
- (m) Assume the wall above the lintel is reinforced vertically at 32 in o.c.
- (n) There is a continuous 8 inch bond beam at the top of the wall.
- (o) The concentrated live load, P' , is located 7 ft to the right of the centerline of door.

(2) *Problem.* Design the lintel to support the given dead and live loadings.

(3) *Solution.* Since the loading is applied below the apex of the triangle (see figures 8-1 and 8-4), arching action cannot be assumed. The lintel must be designed for the full applied dead and live loading above.

Lintel Depth Determination.

(a) The lintel depth will be determined so that shear reinforcement is not required. To establish the dead loading, assume a lintel depth of 24 inches.

(b) The lintel loadings are as follows:

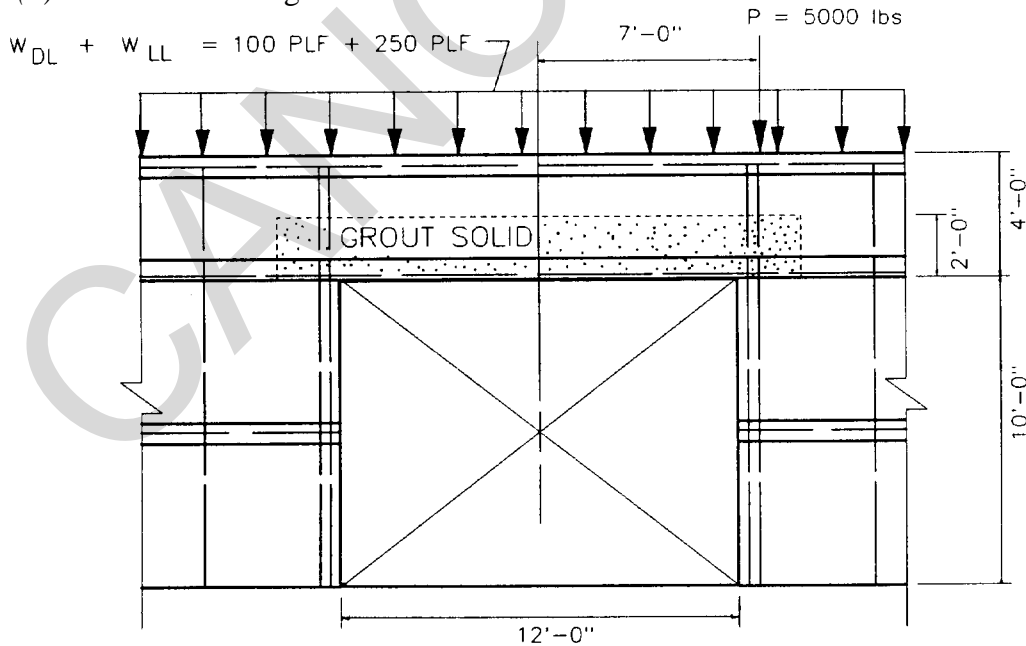

U. S. ARMY CORPS OF ENGINEERS

Figure 8-4. Example 2 wall elevation.

Design dead load is “w”. Unit weights of 8-inch wall are; solidly grouted, 92 psf; and grouted at 32 inches on center, 65 psf.

$$w = w_{DL} + 2w_{lin} + w_{wall}$$

Where:

$$\begin{aligned} w_{lin} &= \text{the weight of the lintel, lbs/ft} \\ &= (92 \text{ psf})(2.00 \text{ ft}) = 184 \text{ plf} \\ w_{wall} &= (92 \text{ psf})(0.67 \text{ ft}) + (65 \text{ psf})(1.33 \text{ ft}) \\ &= 62 \text{ plf} + 86 \text{ plf} = 148 \text{ plf} \\ w &= 100 + 184 + 148 = 432 \text{ plf} \end{aligned}$$

Design uniform live load is w_{LL} .

$$w_{LL} = 250 \text{ plf}$$

Uniform distribution of the concentrated live load on the lintel, w_p , is determined as follows: (See figure 8-1 for an explanation of the terms used in this distribution.)

$$w_p = \frac{P'}{2h'\tan \alpha} = \frac{P'}{1.155h'} = \frac{5000}{1.155(2.0)} = 2165 \text{ plf}$$

And;

$$\begin{aligned} a &= (h'\tan \alpha + 0.5L - 0x') \\ &= (0.577W + 0.5L - x') \\ &= [(0.577 \times 2.0) + 0.5(12.67) - 7.0] \\ &= 0.49 \text{ ft} \end{aligned}$$

(c) Determine the shear loading, V , as follows:

$$V = \frac{w_{LL}L}{2} + \frac{wL}{2} + \frac{w_p a(2L - a)}{2L}$$

Where:

$$\begin{aligned} L &= \text{The design span length of the lintel, feet.} \\ &= 12.00 \text{ ft} \pm 0.67 \text{ ft} = 12.67 \text{ ft} \end{aligned}$$

$$\begin{aligned} V &= \frac{(250)(12.67)}{2} + \frac{(432)(12.67)}{2} \\ &\quad + \frac{(2165)(0.49)(2 \times 12.67 - 0.49)}{2(12.67)} = 5361 \text{ lbs} \end{aligned}$$

(d) Minimum lintel depth without shear reinforcement, d_{reqd} , is determined as follows:

$$d_{reqd} = \frac{5361}{(37)(7.62)} = 19.01 \text{ in}$$

Where:

$$\begin{aligned} F_v &= \text{The allowable shear stress, psi.} \\ &= 1.0\sqrt{f'_m} = \sqrt{1350 \text{ lb/in}^2} = 37 \text{ lb/in}^2 \\ b &= \text{the actual lintel width, in.} \\ &= 7.62 \text{ in} \end{aligned}$$

$$d_{reqd} = \frac{5361}{(37)(7.62)} = 19.01 \text{ in}$$

For a 24 inch deep lintel, the actual effective beam depth, d_{act} , is 20.62 inches.

$$d_{act} = 20.62 \text{ in} > d_{reqd} = 19.01 \text{ in}$$

...24-Inch Lintel Depth O.K.

Flexural Check

(a) Determine the maximum moment due to loading, M_{max} , as follows:

$$\begin{aligned} M_{max} &= \frac{w_{LL}L^2}{8} + \frac{w_{DL}L^2}{8} + \frac{w_p a^2}{4} \\ &= \frac{(250)(12.67)^2}{8} + \frac{(432)(12.67)^2}{8} + \frac{(2165)(0.49)^2}{4} \\ &= 13.814 \text{ ft}\cdot\text{lb} \end{aligned}$$

(b) Determine the area of reinforcement, A_{sb} , required to provide a balanced steel ratio, p_e .

$$A_{sb} = (p_e)(b)(d)$$

Where:

$$\begin{aligned} p_e &= 0.0027 \text{ (See table 5-9)} \\ b &= \text{The lintel width} = 7.62 \text{ inches} \\ d &= \text{The effective depth of lintel} = 20.62 \text{ inches} \end{aligned}$$

TM 5-809-3/NAVFAC DM-2.9/AFM 88-3, Chap. 3

$$A_{sb} = 0.0027(7.62)(20.62) = 0.424 \text{ in}^2$$

(c) The minimum reinforcing steel required above any wall opening is 1-#4 bar, $A_s = 0.20 \text{ in}^2$.

$$A_s = 0.20 \text{ in}^2 < A_{sb} = 0.424 \text{ in}^2$$

Try 2-#4 bars ($A_s = 0.40 \text{ in}^2$) as shown in figure 8-5.

(d) The masonry resisting moment, M_{rm} , is determined as follows:

$$M_{rm} = \frac{F_m k j b d^2}{2(12)}$$

Where:

$$k = \left[(np)^2 + 2np \right]^{1/2} - np$$

And:

$$p = \frac{A_s}{bd} = \frac{0.40}{(7.62)(20.62)} = 0.0025$$

$$k = \left[(21.5 \times 0.0025)^2 + 2(21.5 \times 0.0025) \right]^{1/2} - (21.5 \times 0.0025) = 0.28$$

$$j = 1 - k/3 = 1 - (0.28/3) = 0.906$$

$$M_{rm} = \frac{(450)(0.28)(0.906)(7.62)(20.62)^2}{2(12 \text{ in/ft})}$$

...O.K.

(e) The reinforcing steel resisting moment, M_{rs} , is determined as follows:

$$M_{rs} = \frac{F_s A_s j d}{12} = \frac{(24,000)(0.4)(0.906)(20.62)}{12 \text{ in/ft}} = 14,945 \text{ ft-lb}$$

$$M_{rs} = 14,945 \text{ ft-lb} > M_{max} = 13,814 \text{ ft-lb}$$

...Flexure O.K.

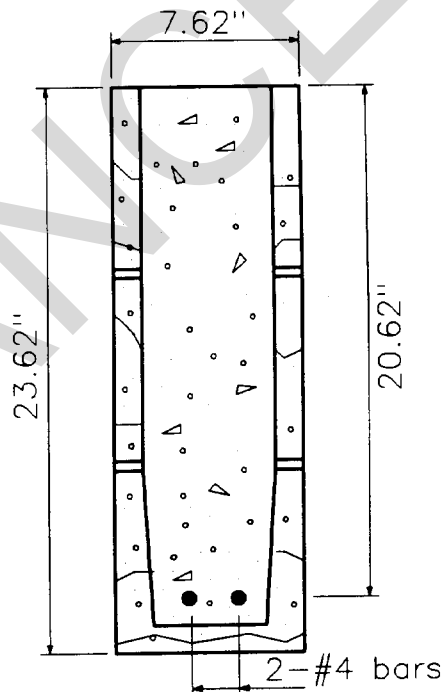

U. S. ARMY CORPS OF ENGINEERS
 Figure 8-5. Example 2 lintel cross section.

Note: Steel governed the design. Also, note M_{rm} and M_{rs} could have been taken from appendix C, table C-9.

Deflection Check

(a) Determine the moment that causes flexural cracking of the lintel section, M_{cr}, as follows:

$$M_{cr} = \frac{f_r I_g}{Y_t}$$

Where:

$$f_r = 2.54\sqrt{f'_m} = 2.54\sqrt{1350} \text{ lb/in}^2 = 91.8 \text{ lb/in}^2$$

$$I_g = (7.62)(23.62)^3/12 = 8368 \text{ in}^4$$

$$Y_t = 23.62/2 = 11.81 \text{ in}$$

$$M_{cr} = \frac{(91.8)(8368)}{(11.81)(12 \text{ in/ft})} = 5420 \text{ ft-lb}$$

Since M_{cr} < M_{max}; the lintel is cracked, therefore the effective moment of inertia, I_e, must be computed as follows:

$$I_e = (M_{cr}/M_{max})^3 I_g + [1 - (M_{cr}/M_{max})^3] I_{cr}$$

Where:

$$I_{cr} = \text{The moment of inertia of the cracked section, in}^4$$

$$I_{cr} = \frac{b(kd)^3}{3} + nA_s(d - kd)^2 \text{ in}^4$$

$$= \frac{7.62(0.28 \times 20.62)^3}{3} + 21.5(0.4)[20.62 - (0.28)(20.62)]^2$$

$$= 2384 \text{ in}^4$$

Note. I_{cr} could be taken from table C-9.

$$I_e = \left[\frac{5420}{13,814} \right]^3 (8368) + \left[1 - \left[\frac{5420}{13,814} \right]^3 \right] (2384) = 2745$$

(b) Determine the lintel deflection, m_t, as follows:

$$\Delta_{mt} = \Delta_{ms} = (3)(\Delta_{ml})$$

$$= \frac{5w_{LL}L^4}{384EI} + (3) \left[\frac{5w_{DL}L^4}{384EI} \right]$$

Since the line of action of the concentrated load is located off the lintel span and the vertical height of the distribution triangle is only 2 feet, the effects of the concentrated load on the centerline deflection is negligible and will be ignored.

$$\Delta_{mt} = \frac{5(250)(12.67)^4(1728 \text{ in}^3/\text{ft}^3)}{384(1,350,000)(2745)}$$

$$+ (3) \left[\frac{5(432)(12.67)^4(1728 \text{ in}^3/\text{ft}^3)}{384(1,350,000)(2745)} \right] = 0.242 \text{ in}$$

(c) Determine the allowable lintel deflection, Δ_{allow}, and compare to the maximum lintel deflection, Δ_{max} = 0.30 in, as follows:

$$\Delta_{allow} = \frac{L}{600} = \frac{(12.67)(12 \text{ in/ft})}{600} = 0.253 \text{ in}$$

$$\Delta_{allow} < \Delta_{max}; \text{ Use } \Delta_{allow} = 0.253 \text{ in}$$

$$\Delta_{allow} = 0.253 \text{ in} > \Delta_m = 0.242 \text{ in}$$

...Deflection O.K.

Bearing Check.

(a) Determine the maximum bearing stress, f_{brg(max)}, assuming a triangular stress distribution as follows:

$$f_{brg(max)} = \frac{V_{max}}{A_{brg}}$$

Where:

$$A_{brg} = 8 \text{ in} \times 7.62 \text{ in} = 61 \text{ in}^2$$

$$f_{brg(max)} = \frac{2(5361)}{61} = 176 \text{ lb/in}^2$$

(b) Determine the allowable bearing stress, F_{brg}, as follows:

TM 5-809-3/NAVFAC DM-2.9/AFM 88-3, Chap. 3

$$F_{brg} = 0.25(f'_m) = 0.25(1350 \text{ lb/in}^2) = 337 \text{ lb/in}^2$$

$$F_{brg} = 337 \text{ lb/in}^2 > f_{brg(max)} = 176 \text{ lb/in}^2$$

...Bearing O.K.

(4) *Summary.* The 8-inch × 24-inch CMU lintel reinforced with 2-#14 bars is sufficient.

c. *Design example 3.*

(1) *Given.*

- (a) 8-inch CMU loadbearing wall
- (b) Wall height = 12 ft
- (c) Wall panel length = 30 ft
- (d) Uniform roof live load (w_{LL}) = 600 lb/ft
- (e) Uniform roof dead load (w_{DL}) = 150 lb/ft
- (f) Type S mortar
- (g) $f'_m = 1350$ psi
- (h) $f'_m = 1/3f'_m = 450$ psi
- (i) $E_m = 1000f'_m = 1,350,000$ psi
- (j) Reinforcement:
 $f_y = 60,000$ psi
 $F_s = 24,000$ psi
 $E_s = 29,000,000$

(k) $n = \frac{E_s}{E_m} = \frac{29,000,000}{1,350,000} = 21.5$

(l) Two doors, 12-feet wide by 10-feet high, are located in the wall as shown in figure 8-6.

(2) *Problem.* Design the lintel over the doors.

(3) *Solution.* The three masonry courses above the opening will be solidly grouted and used as the lintel. The masonry lintel will be analyzed as a braced frame member. The ACI 318 moment and shear coefficients will be used to determine the approximate design moments and shears.

Flexure Check. The masonry frames meet all of the requirements of ACT 318 which allows the use of the approximate method. Determine the maximum moment envelope using the ACT 318 moment coefficients.

(a) Determine the maximum negative moment at the face of the interior support, M_{si} , as follows:

$$M_{si} = \frac{w_{tot}L^2}{9}$$

Where:

$$w_{tot} = w + w_{DL} + w_{LL}$$

And;

$$w = \text{The lintel weight, lb/ft}$$

$$= (92 \text{ psf})(2 \text{ ft}) = 184 \text{ lb/ft}$$

$$w_{tot} = 184 + 150 + 600 = 934 \text{ plf}$$

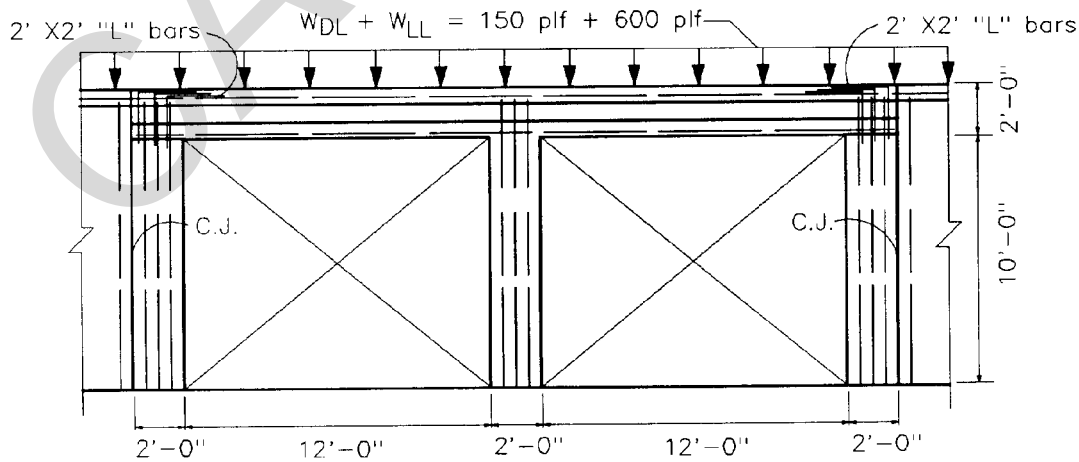

U. S. ARMY CORPS OF ENGINEERS

Figure 8-6. Example 3 wall elevation.

$$M_{si} = \frac{(934)(12 \text{ ft})^2}{9} = 14,944 \text{ ft-lb}$$

(b) Determine the maximum negative moment at the interior face of the exterior support, M_{se} , as follows:

$$M_{se} = \frac{wL^2}{16} = \frac{(934)(12)^2}{16} = 8,406 \text{ ft-lb}$$

(c) Determine the maximum positive moment, M_{sm} , as follows:

$$M_{sm} = \frac{wL^2}{14} = \frac{(934)(12)^2}{14} = 9,607 \text{ ft-lb}$$

Note. The maximum negative moment at the face of the interior support, $M_{si} = 14,944 \text{ ft-lb}$, governs the flexural design.

(d) Determine the area of reinforcement, A_{sb} , required to provide a balanced steel ratio, P_e .

$$A_{sb} = (p_e)(b)(d)$$

Where:

$p_e = 0.0027$ (See table 5-9)

$b =$ The lintel width = 7.62 in

$d =$ The effective depth of lintel = 20.62 in

$$A_{sb} = 0.0027(7.62)(20.62) = 0.424 \text{ in}^2$$

(e) The minimum reinforcing steel required above any wall opening is 1-#4 bar, $A_s = 0.20 \text{ in}^2$.

$$A_s = 0.20 \text{ in}^2 < A_{sb} = 0.424 \text{ in}^2$$

Try 2-#4 bars ($A_s = 0.40 \text{ in}^2$) as shown in figure 8-7.

(f) Obtain the masonry resisting moment, M_{rm} , and the reinforcing steel resisting moment, M_{rs} , from table C-9:

$$M_{rm} = 15,448 \text{ ft-lb}$$

$$M_{rs} = 14,954 \text{ ft-lb}$$

Note. The reinforcing moment, M_{rs} , governs the design.

$$M_{rs} = 14,954 \text{ ft-lb} > M_{si} = 14,944 \text{ ft-lb}$$

...Flexure O.K.

(g) The steel reinforcement detailing should be as described below and shown in figure 8-6. Since the reinforcement in the top of wall bond beam is required to be continuous, as a diaphragm chord, bar cutoffs locations need not be considered. Frame action must be maintained at the corners, so corner bars will be used.

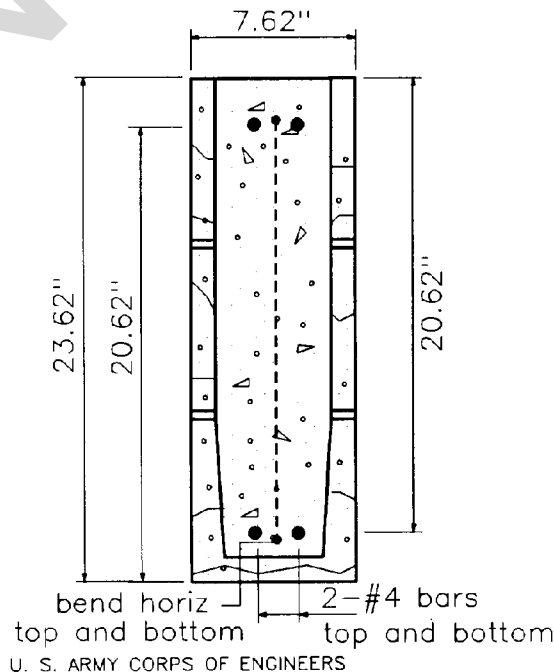

Figure 8-7. Example 3 cross section.

TM 5-809-3/NAVFAC DM-2.9/AFM 88-3, Chap. 3

Deflection Check.

(a) The effective moment of inertia, I_e , is determined as follows:

$$I_e = (M_{cr}/M_{max})^3 I_g + [1 - (M_{cr}/M_{max})^3] I_{cr}$$

Where:

$$M_{cr} = \frac{f_r I_g}{Y_t}$$

And;

$$f_r = 2.5\sqrt{f'm} + 2.5\sqrt{1350 \text{ lb/in}^2} = 91.8 \text{ lb/in}^2$$

$$I_g = (7.62)(23.62)^3/12 = 8368 \text{ in}^4$$

$$Y_t = 23.62/2 = 11.81 \text{ in}$$

$$M_{cr} = \frac{(91.8)(8368)}{11.81(12 \text{ in/ft})} = 5420 \text{ ft-lb}$$

I_{cr} = The moment of inertia of the cracked section, in^4

$$I_{cr} = 2,393 \text{ in}^4 \text{ (From table C-9)}$$

M_{max} = The maximum applied moment, ft-lb. (Use the average of the maximum negative moment, M_{si} , and the maximum positive moment, M_{sm} , in computing I_e .)

$$M_{max} = \frac{14944 + 9607}{2} = 12276 \text{ ft-lb}$$

$$I_e = \left[\frac{5420}{12276} \right]^3 (8368) + \left[1 - \left[\frac{5420}{12276} \right]^3 \right] (2383) = 2889 \text{ in}^4$$

$I_e = 2899 \text{ in}^4 < I_g = 8368 \text{ in}^4$; Therefore use I_e in the deflection equations.

(b) The maximum total lintel deflection, Δ_{ml} , occurs when both spans are loaded with the uniform dead load and one span is loaded with the uniform live load and is determined as follows:

$$\Delta_{ml} = \Delta_{ms} + (3)(\Delta_{ml})$$

Since the long term dead load deflection, Δ_{ml} , is increased by a factor of 3, the dead and live load deflections will be determined separately.

(c) Determine the long term (dead load) deflection, Δ_{ml} , as follows:

$$\Delta_{ml} = (3) \frac{5L^2}{48EI} \left[M_{sm} - \frac{1}{10} (M_{se} + M_{si}) \right]$$

Note. This equation was derived using the conjugate beam method and is the general expression for the elastic mid-span deflection for a uniformly loaded span with unequal end moments. The shear and moment diagrams for the load case that produces maximum dead load deflection are shown in figure 8-8.

Where:

M_{sm} = The positive moment at mid-span, ft-lb

$$= M_{max} - \frac{w(0.049L)^2}{2} = 0.0377wL^2$$

And;

M_{max} = The maximum positive moment in the span, ft-lb

$$= -\frac{wL^2}{16} + \frac{w(0.451L)^2}{2} = 0.0389 wL^2$$

$$M_{sm} = 0.0389wL^2 - \frac{(0.049L)^2w}{2} = 0.0377wL^2$$

$$= 0.0377(33)(12)^2(12 \text{ in/ft}) = 21,758 \text{ in-lb}$$

$$M_{se} = \frac{1}{16} (334)(12)^2(12 \text{ in/ft}) = 36,072 \text{ in-lb}$$

$$M_{si} = \frac{1}{9} (334)(12)^2(12 \text{ in/ft}) = 64,064 \text{ in-lb}$$

$$\Delta_{ml} = (3) \left[\frac{5(12)^2(144 \text{ in}^2/\text{ft}^2)}{48(1,350,000)(2899)} \right] \times \left[21,758 - \frac{1}{10} (36,072 + 64,062) \right] = 0.018 \text{ in}$$

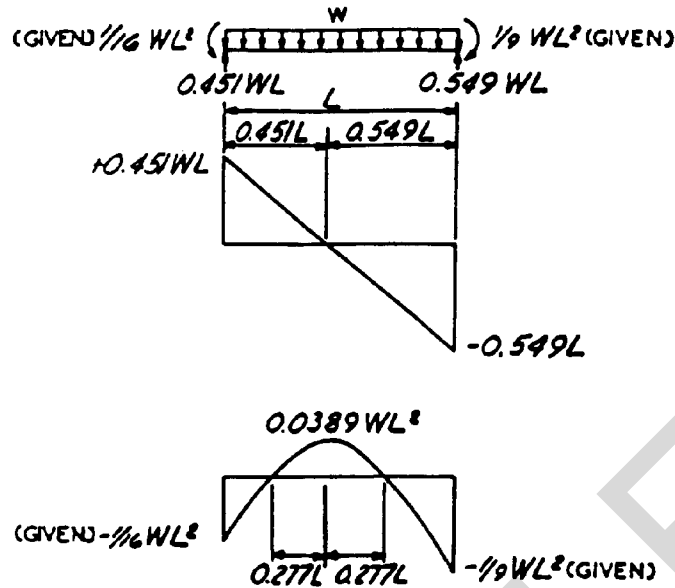

U. S. ARMY CORPS OF ENGINEERS

Figure 8-8. Dead load shear and moment diagrams.

(d) Determine the short term (live load) deflection, Δ_{ms} , as follows:

$$\Delta_{ms} = \frac{5L^2}{48EI} \left[M_{sm} - \frac{1}{10} (M_{se} + M_{si}) \right]$$

Note. The shear and moment diagrams for the load case that produces maximum live load deflection are shown in figure 8-9.

Where:

$$\begin{aligned} M_{sm} &= -0.03wL^2 + \frac{(0.451L)^2w}{2} - \frac{(0.549L)^2w}{2} \\ &= 0.072wL^2 = 0.071(600)(12 \text{ ft})^2(12 \text{ in/ft}) \\ &= 73,613 \text{ in-lb} \end{aligned}$$

Note. M_{max} was assumed to be located at the same point on the beam as determined from the dead load analysis. This is an approximate method of determining the shear and moment diagrams, and is reasonably accurate. The designer may decide to make another reasonable assumption or use a more accurate method of analysis, but the difference in the results will be small.

$$\begin{aligned} M_{se} &= 0.03(600)(12)^2(12 \text{ in/ft}) = 31,104 \text{ in-lb} \\ M_{si} &= 0.079(600)(12)^2(12 \text{ in/ft}) = 81,907 \text{ in-lb} \end{aligned}$$

$$\begin{aligned} \Delta_{ms} &= \left[\frac{5(12)^2(144 \text{ in}^2/\text{ft}^2)}{48(1,350,000)(2899)} \right] \\ &\quad \times \left[73,613 - \frac{1}{10} (31,104 + 81,907) \right] = 0.034 \text{ in} \end{aligned}$$

$$\Delta_{mt} = 0.018 \text{ in} + 0.034 \text{ in} = 0.052 \text{ in}$$

(e) Determine the allowable lintel deflection, Δ_{allow} , and compare to the maximum lintel deflection, $\Delta_{max} = 0.30 \text{ in}$, as follows:

$$\Delta_{allow} = \frac{L}{600} = \frac{(12)(12 \text{ in/ft})}{600} = 0.24 \text{ in}$$

$$\Delta_{allow} < \Delta_{max}; \text{ Use } \Delta_{allow} = 0.24 \text{ in}$$

$$\Delta_{allow} = 0.24 \text{ in} > \Delta_{mt} = 0.052 \text{ in}$$

...Deflection O.K.

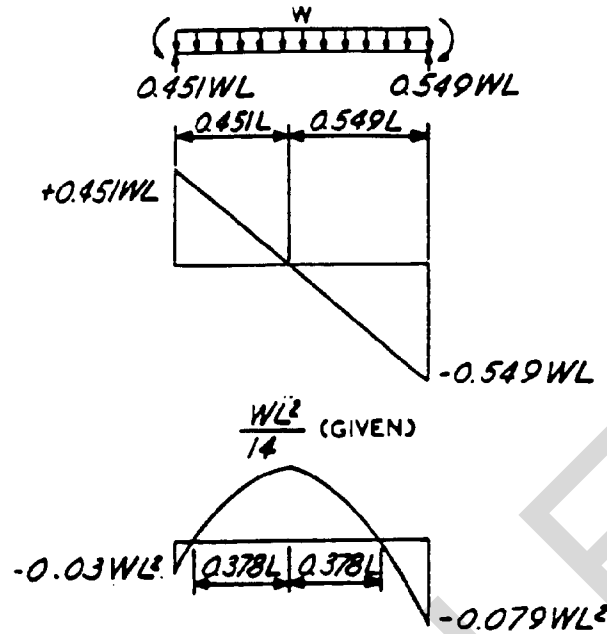

U. S. ARMY CORPS OF ENGINEERS

Figure 8-9. Live load shear and moment diagrams.

Shear Check.

(a) Determine the shear stress in the lintel, F_v , using the ACI shear coefficients as follows:

$$f_v = \frac{V}{bd}$$

The shear stress at the face of the first interior support, f_{v1} , is determined as follows:

$$f_{v1} = \frac{V_1}{bd}$$

Where:

V_1 = The shear force at the first interior support, lb
 $= 1.15wL/2 = 1.15(934)(12)/2 = 6445$ lb

$$f_{v1} = \frac{V_1}{bd} = \frac{6445}{(7.62)(20.62)} = 41.02 \text{ lb/in}^2$$

The shear stress at the face of the exterior support, f_{v2} , is determined as follows:

$$f_{v2} = \frac{V_2}{bd}$$

Where:

V_2 = The shear force at the exterior support, lb
 $= wL/2 = (934)(12)/2 = 5604$ lbs

$$f_{v2} = \frac{V_2}{bd} = \frac{5604}{(7.62)(20.62)} = 35.7 \text{ lb/in}^2$$

Note. The shear stress at the first interior support governs the design.

So; $f_v = f_{v1} = 41.02 \text{ lb/in}^2$

(b) Determine the allowable shear stress, F_v , as follows:

$$F_v = 1.0\sqrt{f'_m} = \sqrt{1350} \text{ lb/in}^2 = 36.7 \text{ lb/in}^2$$

$f_v = 41.02 \text{ psi} > F_v = 36.7 \text{ psi}$; Therefore, shear reinforcement is required in the beam at the interior support. Since $f_v > 20 \text{ psi}$ and there is required negative reinforcement, web reinforcement must be provided to carry the entire shear for a distance of one-sixteenth the clear span beyond the point of inflection. The allowable shear load based on 20 psi, V_{allow} , is:

$$V_{allow} = (20)(7.62)(20.62) = 3142 \text{ lb}$$

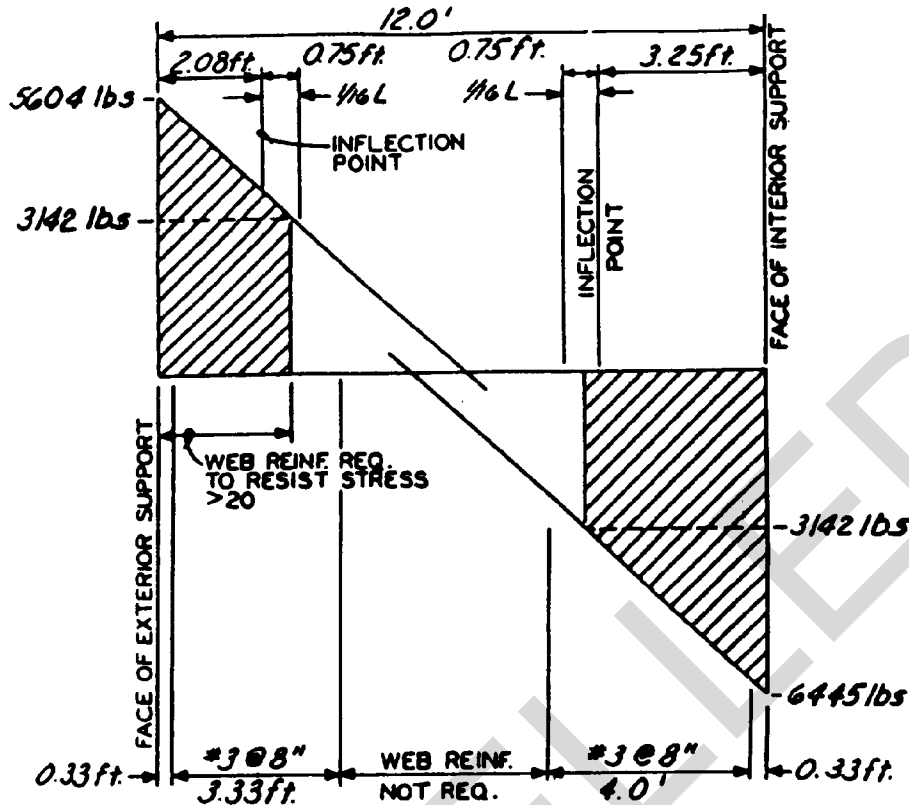

U. S. ARMY CORPS OF ENGINEERS

Figure 8-10. Location of web reinforcement in lintel.

$V_2 = 5604 \text{ lb} > V_{\text{allow}} = 3142 \text{ lb}$; Therefore, web reinforcement is required at both ends of the span.

(c) The area of the shear reinforcement required, A_v , is determined as follows:

$$A_v = \frac{V_1 s}{F_s d}$$

Where:

F_s = The allowable stress in the steel, psi
 = 24,000 psi

s = The spacing of the shear reinforcement, in inches. The spacing of shear reinforcement should not exceed $d/2$ nor 24 inches. The maximum spacing, s_{max} , of the shear reinforcement is:

$$s_{\text{max}} = d/2 = 20.62 \text{ in}/2 = 10.31 \text{ in}$$

Use $s = 8 \text{ in}$ (modular in reinforcement CMU)

$$A_v = \frac{(6445 \text{ lb})(8 \text{ in})}{(24,000 \text{ psi})(20.62 \text{ in})} = 0.104 \text{ in}^2$$

Use 1-#3 bar ($A_v = 0.11 \text{ in}^2$), with web reinforcement provided starting at 4 inches from the face of the support, spaced at 8 inches on center, to the first 8-inch module beyond the inflection point plus one-sixteenth of the span as shown on figure 8-10.

(d) When all of the shear is resisted by the reinforcement the maximum allowable shearing stress, $\text{Max } F_v$, must be checked as follows:

$$\text{Max } F_v = 3\sqrt{f'_m} \text{ not to exceed } 120 \text{ psi} \\ = 3\sqrt{1350 \text{ lb/in}^2} = 110 \text{ lb/in}^2 < 120 \text{ lb/in}^2$$

Use $\text{Max } F_v = 110 \text{ lb/in}^2$

$$f_v = 41.02 \text{ lb/in}^2 < \text{Max } F_v = 110 \text{ lb/in}^2$$

...Shear O.K.

TM 5-809-3/NAVFAC DM-2.9/AFM 88-3, Chap. 3

(e) Since the top of the lintel is the top of the wall, the top face compression region of the lintel must be given lateral support. The maximum distance between points of lateral support, l_c , is determined as follows:

$$l_c = 32(b) = 32(7.62) = 244 \text{ in} = 20.33 \text{ ft}$$

(4) *Summary.* The 8-inch by 24-inch CMU lintel with 2-#4 bars top and bottom and 1-#3 @ 8" o.c. shear reinforcement located as shown in figure 8-10 is sufficient. The top of the lintel must be laterally supported at a maximum spacing of 20 feet.

CANCELLED

CHAPTER 9

COLUMNS AND PILASTERS

9-1. Introduction. This chapter covers the design of reinforced masonry columns and pilasters. These structural elements are defined by their sectional configurations and heights. A masonry column is a vertical compression member whose height exceeds three times its thickness and whose width is less than one and one-half times its thickness. Figure 9-1 shows an isolated CMU column supported by a spread footing. A masonry pilaster is a vertical member of uniform cross section built as an integral part of a wall which may serve as either a vertical beam or a column or both. A pilaster projects from one or both faces of an unreinforced wall and usually projects in a reinforced wall. Figure 9-2 shows details of a typical reinforced CMU pilaster. Pilasters are designed similar to columns except that pilasters are laterally supported in the direction of the wall, while columns are typically unsupported in both directions. General design criteria, section properties, and allowable stresses used but not contained herein are covered in chapter 5.

9-2. Minimum requirements.

a. Limiting dimensions. The least nominal dimension of a masonry column or pilaster will be 12 inches, except that 8 inches minimum may be used provided the axial stress is not more than one-half the allowable axial stress.

b. Vertical reinforcement. The vertical reinforcement will not be less than $0.005A_g$, nor more than $0.04A_g$, where A_g is the gross area of the column or pilaster in square inches. A minimum of four No. 4 bars will be used. Bar lap splice lengths will be sufficient to transfer the design loads in the reinforcement, but not less than 48 bar diameters.

c. Lateral ties. All longitudinal bars for columns or pilasters will be enclosed by lateral ties. The minimum lateral tie size will be #2 bars for #7 or smaller vertical reinforcement and #3 bars for larger vertical reinforcement. The ties will be spaced not more than 16 bar diameters, 48 tie diameters, or the least nominal

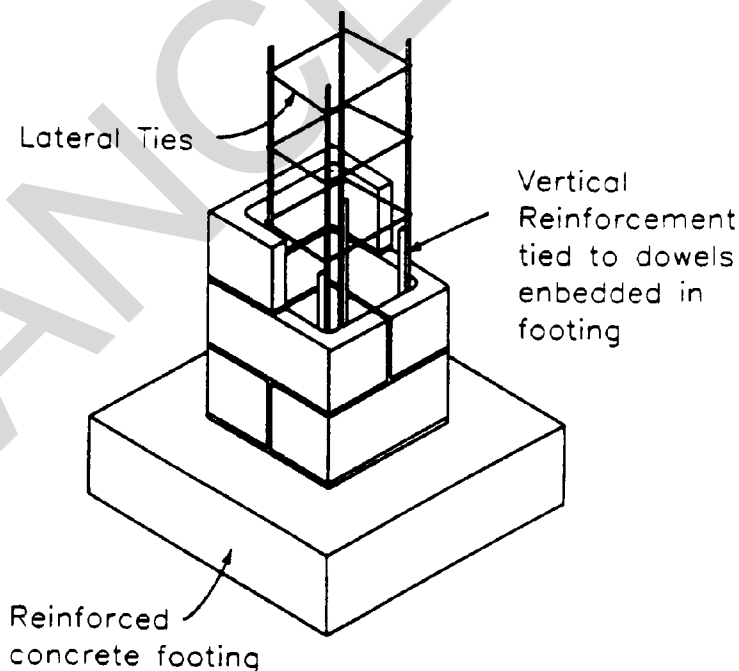

U. S. ARMY CORPS OF ENGINEERS

Figure 9-1. Isolated concrete masonry column.

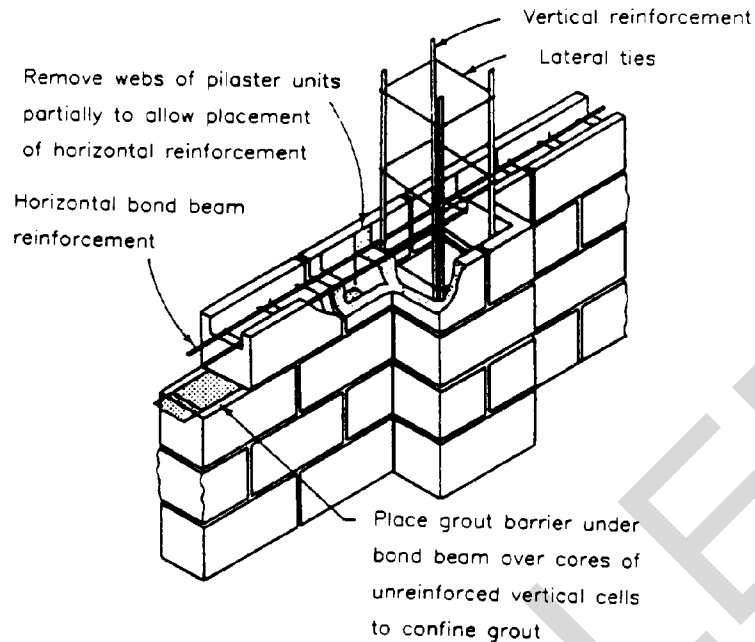

U. S. ARMY CORPS OF ENGINEERS

Figure 9-2. Concrete masonry pilaster with continuous bond beam.

dimension of the column or pilaster. Lateral ties will be in contact with the vertical steel and not in the horizontal masonry bed joints. Ties will be arranged such that every corner and alternate longitudinal bar will be laterally supported by the corner of a lateral tie with an included angle of not more than 135 degrees or by a hook at the end of the tie. Bars which are unsupported by lateral ties will be spaced no further than 6 inches from a laterally supported bar. Hooks at the end of ties will turn a minimum of 135 degrees plus an extension of at least 6 longitudinal bar diameters, but not less than 4 inches at the free end of the tie. Lateral ties shall be placed not less than 1½ inches nor more than 3 inches from the top of the column. Additional ties of three #3 bars shall be placed within the top 5 inches of the column or pilaster.

9-3. Loadings. Columns and pilasters must withstand all applied vertical (axial) loads and in some instances, exterior pilasters (or columns when located between large doors, etc.) must also withstand lateral wind or seismic loads.

a. Axial loads. Vertical (axial) loads usually result from concentrated reactions imposed by beams, girders, or trusses which support dead and live loads from building floor or roof systems and rest on the column or pilaster. In addition, bending stresses in the column or pilaster will result when the axial loads are not applied at the centroid of the column or pilaster. The resulting bending moment will be the axial load, “P”, multiplied by the eccentricity of the load with respect to the centroid, “e”.

b. Lateral (wind) loads. Pilasters are in fact vertical wall stiffeners and will, due to this stiffness, attract lateral wind or seismic loads from the adjacent wall panels. When the adjacent wall is designed and detailed to span horizontally between pilasters, it must be assumed that the pilaster will carry the entire lateral load. However, when the wall panels contain a significant amount of vertical reinforcement as well as horizontal bond beams, lateral loads on the panels will be carried both vertically by the wall panel to the supporting roof or floor systems above and below and horizontally by the pilasters. The proportion of the lateral load transferred in each direction will depend upon the fixity or restraint at the panel edges, the horizontal to vertical span ratio, and the distribution of the applied loads. Curves are available in NCMA TEK No. 24 which provide coefficients that approximate the proportion of wind loads on wall panels that are transferred horizontally to the pilasters.

c. Combined axial and bending. Masonry columns and pilasters will be designed for the combined effects of axial compressive (or tensile) stresses and flexural stresses. All appropriate load combinations will be investigated. When the entire column or pilaster cross sectional area is in compression; i.e., the axial

compressive stress is greater than the bending tensile stress; the entire cross section remains in compression and the section properties will be based upon what is termed the “uncracked section”. This condition occurs when the virtual eccentricity, e_v , is less than or equal to $\frac{1}{6}$ of the thickness, t , of the member. e_v is defined as the ratio of the moment, M , to the axial load, P . Figure 9-3 shows the uncracked section with three loading conditions where e_v is less than or equal to $t/6$. When the flexural tensile stresses exceed the axial compressive stresses (e_v exceeds $t/6$) and the edge of the compressive stress block is at or outside the location of the reinforcing steel, the stress distribution is as shown in figure 9-4a. This condition, where the section is cracked but the reinforcing steel is not in tension, is not a consideration when the unity equation (equation 9-8) is used for design of combined stresses. It is, however, a point used in the development of the interaction diagram for a masonry pilaster or column. When the flexural tensile stresses exceed the axial compressive stresses, a portion of the cross section is cracked and the design cross sectional properties are based upon a reinforced masonry “cracked section” as shown in figure 9-4(b). Since it is assumed that the masonry will not resist tension, the reinforcement must resist all tensile forces. The design will be governed by the compressive stresses (axial and flexural) developed within the masonry section or by the flexural tensile stresses developed in the reinforcement. The combined loading effects will be considered in the design by using the basic unity interaction equation given later in this chapter.

d. *Reaction location.* Special consideration will be given to the effects created by the type and connection conditions of the members (beams, girders, trusses, etc.) supported by the masonry column or pilaster. If these members are not restrained against rotation, the resulting reaction will tend to move toward the edge of the support, increasing the eccentricity of the reaction. When a beam supported on a bearing plate is subject to rotation under loading, the vertical resultant reaction will be assumed at the third point of the bearing plate, as shown in figure 9-5(a). When a supported member displays very little rotation, due to its stiffness or continuity with other supported members, the load will be more uniformly distributed over the length of the plate, and the resulting reaction may be assumed to act at the center of the bearing plate, as shown in figure 9-5(b).

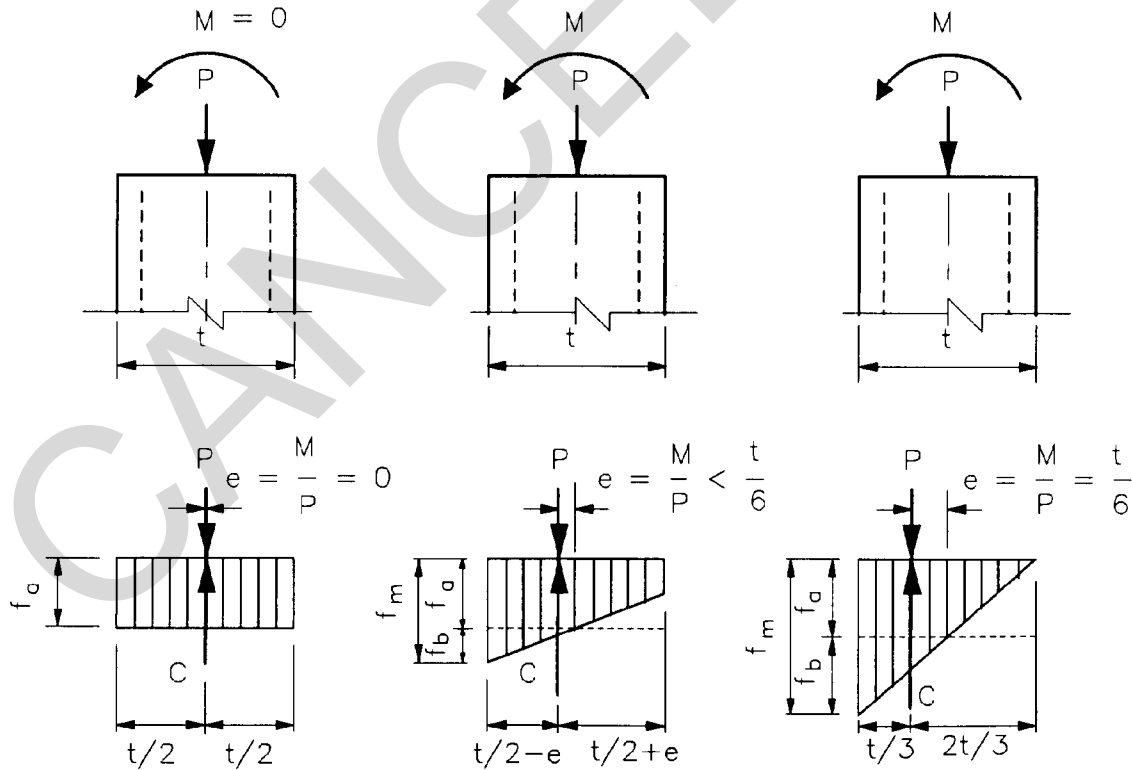

U. S. ARMY CORPS OF ENGINEERS

Figure 9-3. Uncracked section.

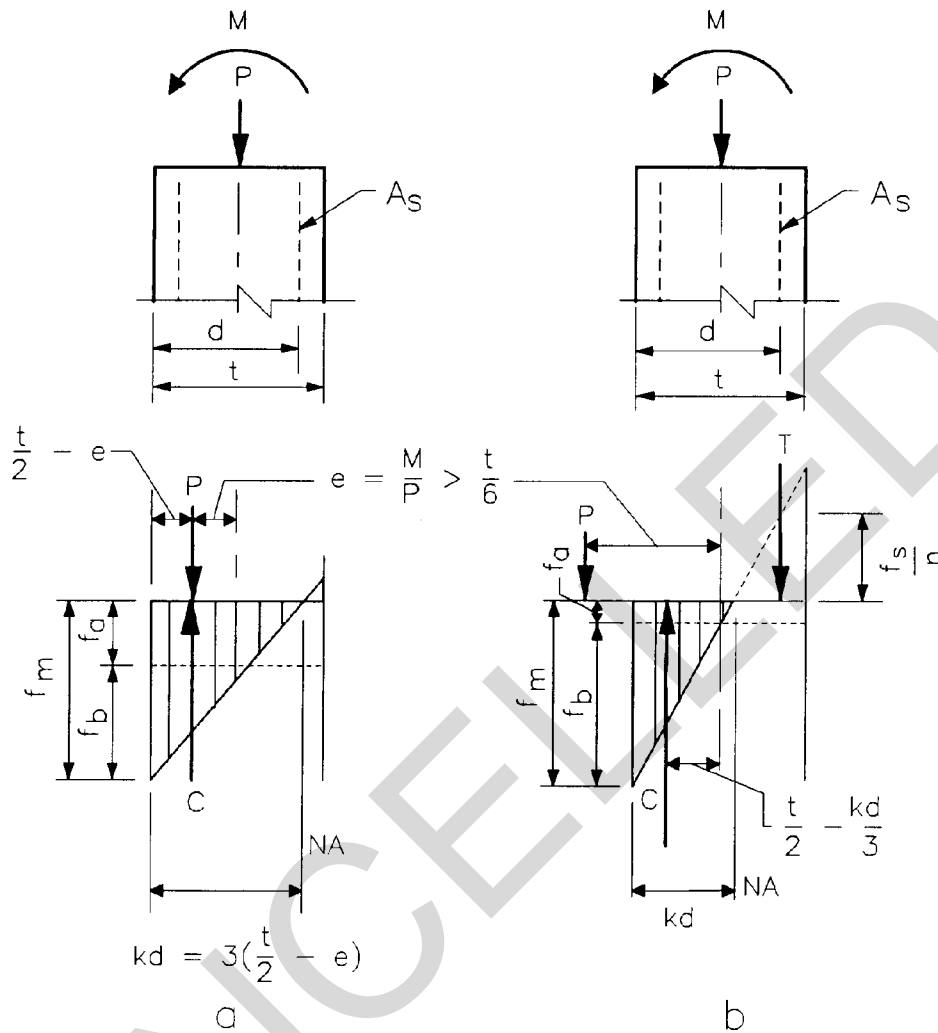

U. S. ARMY CORPS OF ENGINEERS

Figure 9-4. Cracked section.

9-4. General behavior. The behavior of columns and pilasters under axial loading is dependent upon the cross sectional capacity of the column materials and the lateral stability of the column. Figure 9-6 illustrates this relationship between capacity and stability. In very short columns crushing failure occurs as the result of the load exceeding the ultimate material strength and stability does not become a design consideration. For most columns, inelastic deformation of the materials occurs on some portion of the column cross section before general column buckling occurs. Nonetheless, the allowable compressive stresses used during for design of the cross section are reduced to account for potential instability of the column. For long slender columns, elastic buckling failure will occur before any material reaches the yield state.

a. Effective height. The assumed behavior of columns and pilasters is a function of the slenderness of the member. The slenderness is expressed as the ratio of the effective height, h' , to the radius of gyration, r . h' is the product of the clear height of the column, h , and the factor, K , which considers the effects of column end restraint and whether or not lateral deflection (sidesway) occurs at the top of the column. Values of K are provided in table 9-1. Since pilasters act as stiffening elements within a wall, they can be considered laterally supported in the direction parallel to the plane of the wall. However, slenderness effects must be considered in the direction perpendicular to the plane of the wall, and the design for that direction will be based on the effective wall height.

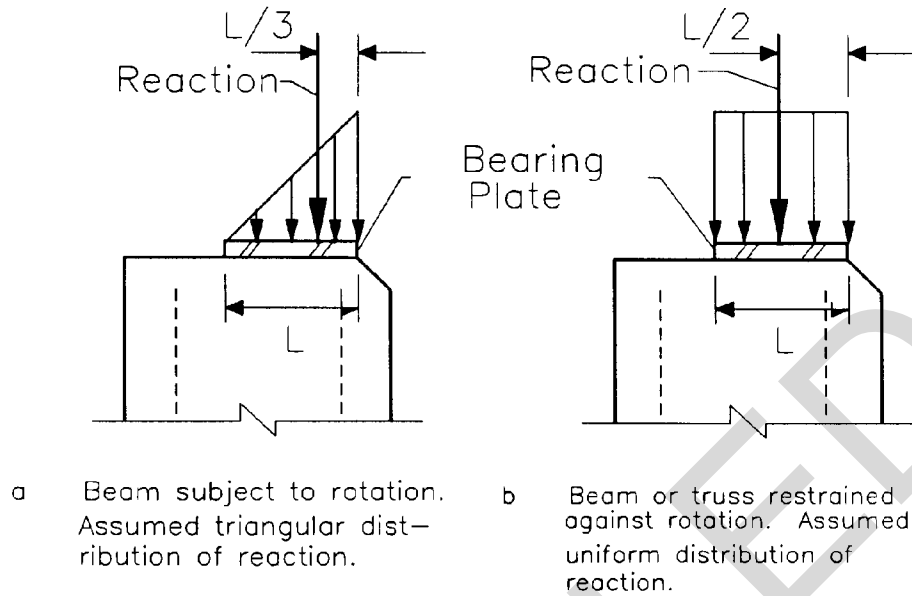

U. S. ARMY CORPS OF ENGINEERS

Figure 9-5. Reaction locations of beams and trusses.

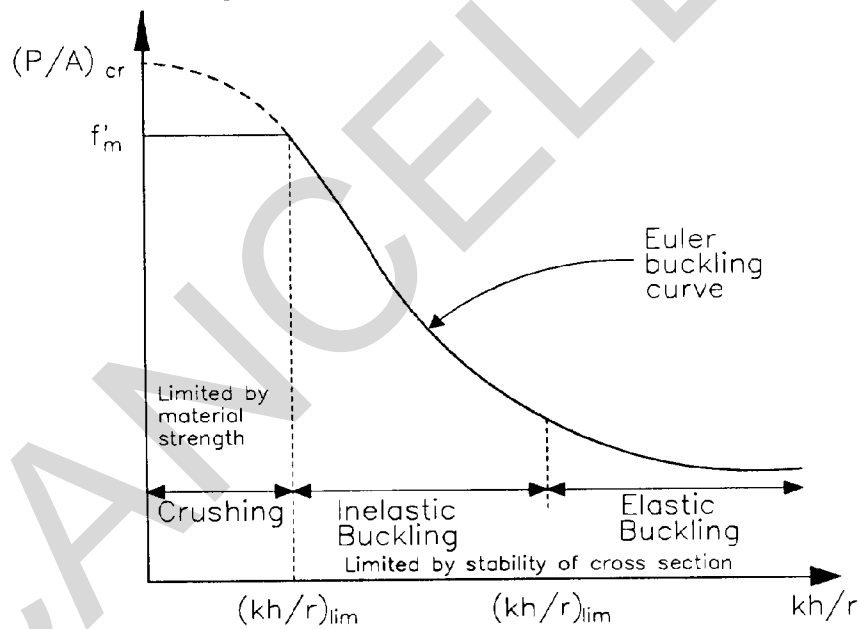

U. S. ARMY CORPS OF ENGINEERS

Figure 9-6. Load carrying capacities of columns vs. Kh/r .

9-5. Design procedures.

a. *Axial compressive stress.* In the design of masonry columns and pilasters, the compressive stress, f_a , is determined as follows:

$$f_a = \frac{P}{A_e} \text{ (psi)} \quad \text{(eq 9-1)}$$

Where

P = The applied axial load, lbs.

A_e = The effective transformed area of the column (or pilaster) based on actual cross sectional dimensions, in^2 .

Buckled shape of column is shown by dashed line	(a)	(b)	(c)	(d)	(e)	(f)
Theoretical K value	0.5	0.7	1.0	1.0	2.0	2.0
Recommended design value when ideal conditions are approximated	0.65	0.80	1.2	1.0	2.10	2.0
End condition code						
					Rotation fixed and translation fixed	Rotation free and translation fixed
					Rotation fixed and translation free	Rotation free and translation free

Reprinted from Manual of Steel Construction Allowable Stress Design, ninth edition, 1989, copyrighted, used with permission of the American Institute of Steel Construction Inc.

Table 9-1. K factors for columns and pilasters.

$$A_3 = [bt + (n - 1)A_s]$$

b = The actual width of the column or pilaster, inches.

t = The least actual thickness of the column or pilaster, inches.

n = Modular ratio.

$$= E_s/E_m$$

E_s = The modulus of elasticity of the reinforcing steel, psi.

E_s = 29,000,000 psi.

E_m = The modulus of elasticity of the masonry, psi.

E_m = 1000f_m for CMU.

f_m = The compressive strength of masonry, psi.

A_s = The cross-sectional area of reinforcing steel, in².

b. Allowable axial compressive stress. The allowable axial compressive stress for masonry columns and pilasters, F_a, is as follows:

$$F_a = [0.18f_m + 0.65(p_g)(F_{sc})][R] \text{ (psi)} \tag{eq 9-2}$$

Where:

p_g = The ratio of the cross-sectional area of the reinforcement to the gross area of the masonry section based on actual dimensions.

$$p_g = A_s/A_g$$

A_g = The gross area of masonry section based on actual dimensions, in².

F_{sc} = Allowable compressive stress in steel, psi.

$$= 0.4f_y$$

R = The stress reduction factor

$$R = 1 - \left[\frac{h'}{40t_n} \right]^3$$

t_n = Least nominal thickness of column or pilaster, inches.

Note. F_a may be increased by a factor of 1.33 when wind or seismic loads are considered.

In equation 9-2, the "0.18f_m" is the allowable axial compressive stress provided by the masonry and the "0.65p_gF_{sc}" is the allowable compressive stress added to the section by the vertical reinforcement. The third

term, R, reduced the stress to the point where buckling will not occur. R also accounts for the increase in moment due to lateral deflection or the P-Delta effect.

c. *Flexural compressive stress.* The computed flexural compressive stress, f_b , is computed as follows:
For an uncracked section ($f_a \geq f_b$);

$$f_b = \frac{6M}{bt^2} \text{ (psi)} \quad \text{(eq 9-3)}$$

Where:

M = The computed bending moment, inch-lbs.

For a cracked section ($F_a < f_b$);

$$f_b = \frac{2M}{bd^2jk} \text{ (psi)} \quad \text{(eq 9-4)}$$

Where:

d = The effective depth of the flexural section measured from the extreme compression fiber to the centroid of the tension reinforcement, inches.

k = The ratio of the depth of the compressive stress to the depth, d.

j = The ratio of the distance between the centroid of the flexural compressive forces and the centroid of the tensile forces to the depth, d.

$j = 1 - k/3$.

d. Allowable flexural compressive stress. The allowable flexural compressive stress for masonry columns and pilasters, F_b , is determined as follows:

$$F_b = 0.33f'_m \text{ (psi)} \quad \text{(eq 9-5)}$$

If $f'_m = 1,350$ psi; Then $F_b = 0.33(1,350) = 450$ psi

Note. F_b may be increased by a factor of 1.33 when wind or seismic loads are considered.

e. *Flexural tensile stress.* When tension reinforcing is required, the steel tensile stress, f_s , will be determined as follows:

$$f_s = \frac{M}{(A_{st})(j)(d)} \text{ (psi)} \quad \text{(eq 9-6)}$$

Where:

A_{st} = The cross sectional area of the reinforcing steel that is considered in tension only, psi.

f. *Allowable flexural tensile stress.* The allowable tensile stress in reinforcing steel, F_s , when the yield strength of the reinforcement is equal to or greater than 60,000 psi is:

$$F_s = 24,000 \text{ (psi)} \quad \text{(eq 9-7)}$$

Note. F_s may be increased by a factor of 1.33 when wind or seismic loads are considered.

g. *Combined loading.* Members subjected to combined axial and flexural stresses will be designed by the basic interaction equation as follows:

$$\frac{f_a}{F_a} + \frac{f_b}{F_b} \leq 1.0 \quad \text{(eq 9-8)}$$

Note. When F_a and F_b are increased by 1.33 for wind or seismic loads, the resulting design will be not less than the design determined using dead and live loads only. Load interaction methods based on accepted principles of mechanics may be used in lieu of equation 9-8.

h. *Design considerations.* The design of masonry columns or pilasters will consider the maximum loading conditions at the top of the member; at (or near) mid-height of the member, where the maximum bending will usually occur; and at the bottom of the member. Normally, masonry columns or pilasters will be given lateral support at the top by roof or floor system members and will be connected to the foundation below with reinforcing dowel bars. For this condition, the conservative assumption is made that the tops and bottoms of the members are simple supports. When other support or fixity conditions exist, calculations will be based on established principles of mechanics. At the top of a column or pilaster, a combination of the axial load, P, the eccentric moment, Pe, and any other loads and moments present will be considered. When determining F_a at the top of the member, the load reduction factor need not be considered. At (or near) the mid-height of a column or pilaster, a combination of axial load, P, the eccentric moment, approximately Pe/2, the lateral load moment, and any other loads and moments present will be considered. At mid-height, the P-Delta effect is at its maximum, thus F_a will be reduced by the load reduction factor, R. Since some value of lateral loads and lateral load moments will generally act in either direction on the member, the maximum combination of axial load, eccentric moment at the mid-height, moments created by lateral loads acting in either direction will be considered.

9-6. Design Example. The following design example illustrates a procedure for designing reinforced masonry pilasters. The design of reinforced masonry columns is very similar and will follow the same procedure except that stability in both directions must be considered in column design.

a. *Given.*

- (1) Truss end reaction (P) = 40 kips
- (2) Eccentricity (e) = 2 inches.
- (3) Height of pilasters (h) = 16 feet
- (4) Spacing of pilasters = 25 feet
- (5) Lateral wind load on wall (w) = 20 psf
- (6) The wind loading, w, acts both inward and outward.
- (7) Masonry:
 - Type S mortar
 - $f'_m = 1350$ psi
 - $F_m = 0.33f'_m = 450$ psi
 - $E_m = 1000f'_m = 1,350,000$ psi
- (8) Reinforcement:
 - $f_y = 60,000$ psi
 - $F_s = 24,000$ psi
 - $E_s = 29,000,000$ psi
- (9) $n = \frac{E_s}{E_m} = \frac{29,000,000}{1,350,000} = 21.5$

b. *Problem.* Determine the pilaster size and vertical reinforcement.

c. *Solution.* The pilaster must be designed to resist the given eccentric axial load in combination with the lateral wind load. The design must be checked at the top and at the mid-height of the pilaster to determine the critical section. The design procedure is to select an economical pilaster cross section and check the selected section for the required loading conditions.

(1) Assumptions.

(a) The wall spans horizontally between pilasters and all lateral loading on the wall is transferred to the pilasters.

(b) The pilasters are pinned at top and bottom.

(c) The initial pilaster cross section will be 16 inches by 16 inches with 6-#9 vertical bars as shown in figure 9-7.

(2) Check the minimum and maximum reinforcement requirements.

$$A_s = \text{The area of reinforcement, in}^2 \\ = 6(1.00 \text{ in}^2) = 6.00 \text{ in}^2$$

$$A_g = \text{The gross area of the pilaster, in}^2 \\ = bt$$

Where:

b = The actual width of the pilaster = 15.62 in.

t = The actual thickness of the pilaster = 15.62 in.

$$A_g = (15.62 \text{ in})(15.62 \text{ in}) = 244 \text{ in}^2$$

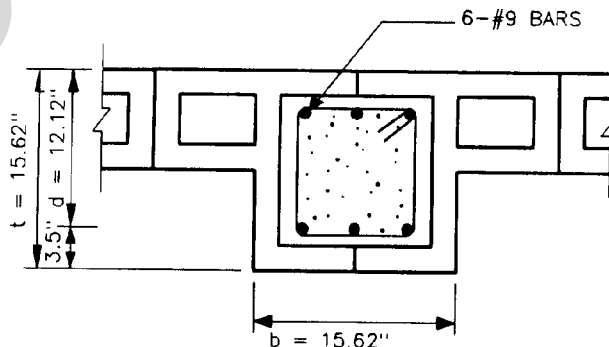

U. S. ARMY CORPS OF ENGINEERS

Figure 9-7. Trial section.

(a) The minimum reinforcement, A_{sMIN} , is determined as follows:

$$A_{sMIN} = 0.005A_g = (0.005)(244) = 1.22 \text{ in}^2$$

$$A_s = 6.00 \text{ in}^2 > A_{sMIN} = 1.22 \text{ in}^2$$

...O.K.

(b) The maximum reinforcement, A_{sMAX} , is determined as follows:

$$A_{sMAX} = 0.04A_g = (0.04)(244) = 9.76 \text{ in}^2$$

$$A_s = 6.00 \text{ in}^2 < A_{sMAX} = 9.76 \text{ in}^2$$

...O.K.

(3) Check the assumed pilaster for the given loadings at the top.

(a) The eccentric moment at the top, M_{eccT} , is determined as follows:

$$M_{eccT} = Pe = 40(2) = 80 \text{ in-kips}$$

(b) The axial compressive stress, f_a , is determined as follows:

$$f_a = \frac{P}{A_e} = \frac{P}{[bt + (n-1)A_s]} =$$

$$= \frac{40 \text{ k (1000 lb/k)}}{[244 \text{ in}^2 + (21.5 - 1)6.00 \text{ in}^2]} = 109 \text{ psi}$$

(c) The allowable compressive stress, F_a , is determined as follows:

$$F_a = [0.18f'_m + 0.65 p_g F_{sc}]R$$

Where:

$$p_g = A_s/A_g$$

$$= (6.00 \text{ in}^2)/(244 \text{ in}^2) = 0.0246$$

R = The stress reduction factor. (Note. R is one at top of pilaster since stability is not a consideration.)

$$F_a = [0.18(1350) + 0.65(0.0246)(24,000)]1.0 = 627 \text{ psi}$$

$$f_a = 109 \text{ psi} < F_a = 627 \text{ psi}$$

...O.K.

(d) The flexural compressive stress, f_b , is determined as follows (Note: Assume a cracked section):

$$f_b = \frac{2M_{eccT}}{bd^2jk}$$

Where:

$$d = 15.62 \text{ in} - 3.5 \text{ in} = 12.12 \text{ in}; \text{ use } d = 12 \text{ in.}$$

A_{sT} = The area of the reinforcement that is in tension, which is 3-#9 bars.

$$A_{sT} = 3(1.00 \text{ in}^2) = 3.00 \text{ in}^2$$

$$p = A_{sT}/bd = 3.00 \text{ in}^2/(15.62 \text{ in} \times 12 \text{ in}) = 0.016$$

$$np = 21.5(0.016) = 0.344$$

$$k = [2np + (np)^2]^{1/2} - np$$

$$= [2(0.344) + (0.344)^2]^{1/2} - 0.344 = 0.554$$

$$j = 1 - k/3 = 1 - (0.554/3) = 0.815$$

$$f_b = \frac{2(80 \text{ in-kips})(1000 \text{ lb/kips})}{(15.62 \text{ in})(12 \text{ in})^2(0.815)(0.554)} = 158 \text{ psi}$$

$$f_b = 158 \text{ psi} < F_m = 450 \text{ psi}$$

...O.K.

(e) Check combined axial and bending compressive stresses using the unity equation. When checking for flexural compression, the unity equation (equation 9-8) becomes:

$$\frac{f_a}{F_a} + \frac{f_b}{F_m} \leq 1.0$$

$$\frac{109}{627} + \frac{158}{450} = 0.17 + 0.35 = 0.48 < 1.0$$

...O.K.

(4) Check the assumed pilaster for the given loadings at mid-height.

(a) The eccentric moment at mid-height, M_{eccM} , is determined as follows:

$$M_{eccM} = Pe/2 = 40(2)/2 = 40 \text{ in-kips}$$

(b) The wind loading moment at mid-height, M_{wind} , is determined as follows:

TM 5-809-3/NAVFAC DM-2.9/AFM 88-3, Chap. 3

$$M_{wind} = \frac{(w)(h^2)}{8}$$

$$= \frac{(20 \text{ psf})(25 \text{ ft})^2 (12 \text{ in/ft})}{8 (1000 \text{ lbs/kip})} = 192 \text{ in-kips}$$

(c) The total moment at mid-height, M_{tot} , is determined as follows:

$$M_{tot} = 40 + 192 = 232 \text{ in-kips}$$

(d) The axial compressive stress, f_a , is determined as follows (Note: The weight of the top half of the pilaster is added to P):

$$f_a = \frac{P}{A_e} = \frac{P}{[bt + (n-1)A_g]}$$

Where:

$$P = 40 + \frac{(244 \text{ in}^2)(16 \text{ ft})(0.150 \text{ k/ft}^3)}{(2)144 \text{ in}^2/\text{ft}^2} = 42 \text{ kips}$$

$$f_a = \frac{42 \text{ k} (1000 \text{ lb/k})}{[244 \text{ in}^2 + (21.5 - 1)6.00 \text{ in}^2]} = 114 \text{ psi}$$

(e) The allowable compressive stress, F_a , is determined as follows:

$$F_a = [0.18f'_m + 0.65 p_g F_{SC}]R$$

$$= [0.18(1350) + 0.65(0.0246)(24,000)]R = 627(R) \text{ psi}$$

Where:

$$R = \left[1 - \left[\frac{h'}{40t_n} \right]^3 \right]$$

$$= \left[1 - \left[\frac{(16 \text{ ft})(12 \text{ in/ft})}{40(16 \text{ in})} \right]^3 \right] = 0.973$$

So;

$$F_a = 627 \text{ psi} (0.973) = 610 \text{ psi}$$

$$f_a = 114 \text{ psi} < F_a = 610 \text{ psi}$$

...O.K.

(f) The flexural compressive stress, f_b , is determined as follows (Note: Assume a cracked section):

$$f_b = \frac{2M_{tot}}{bd^2jk}$$

Where:

$$d = 15.62 \text{ in} - 3.5 \text{ in} = 12.12 \text{ in}; \text{ use } d = 12 \text{ in.}$$

A^{ST} = The area of the reinforcement that is in tension, which is 3-#9 bars.

$$A^{ST} = 3(1.00 \text{ in}^2) = 3.00 \text{ in}^2$$

$$p = A_{sT}/bd = 3.00 \text{ in}^2 / (15.62 \text{ in} \times 12 \text{ in}) = 0.016$$

$$np = 21.5(0.016) = 0.344$$

$$k = \left[2np + (np)^2 \right]^{1/2} - np$$

$$= \left[2(0.344) + (0.344)^2 \right]^{1/2} - 0.344 = 0.554$$

$$j = 1 - k/3 = 1 - (0.554/3) = 0.815$$

$$f_b = \frac{2(232 \text{ in-kips})(1000 \text{ lb/kips})}{(15.62 \text{ in})(12 \text{ in})^2(0.815)(0.554)} = 457 \text{ psi}$$

$$f_b = 457 \text{ psi} < F_m = (450 \text{ psi})(1.33) = 600 \text{ psi}$$

...O.K.

(g) Check the adequacy of section using only the axial load and the moment created by its eccentricity (without the 1/3 increase in allowable stresses for wind loading). The flexural compressive stress, f_b , is determined as follows (Note. Assume a cracked section):

$$f_b = \frac{2M_{eccT}}{bd^2jk}$$

Where:

$$M_{eccT} = Pe/2 = 40(2)/2 = 40 \text{ in-kips}$$

$$f_b = \frac{2(40 \text{ in-kips})(1000 \text{ lb/kips})}{(15.62 \text{ in})(12 \text{ in})^2(0.815)(0.554)} = 79 \text{ psi}$$

$$f_b = 79 \text{ psi} < F_m = 450 \text{ psi}$$

...O.K.

(h) Check combined axial and bending compressive stresses using the unity equation. When checking for flexural compression, the unity equation (equation 9-8) becomes:

$$\frac{f_a}{F_a} + \frac{f_b}{F_m} \leq 1.0$$

$$\frac{114}{610} + \frac{79}{450} = 0.19 + 0.18 = 0.37 < 1.0$$

...O.K.

(i) Check combined axial and bending compressive stresses (including wind loading stresses) using the unity equation. When checking for flexural compression, the unity equation (equation 9-8) becomes:

$$\frac{f_a}{F_a} + \frac{f_b}{F_m} \leq 1.0$$

Where:

$$F_a = 610 \text{ psi (1.33)} = 811 \text{ psi}$$

$$F_m = 450 \text{ psi (1.33)} = 600 \text{ psi}$$

$$\frac{114}{811} + \frac{457}{600} = 0.14 + 0.76 = 0.90 < 1.0$$

...O.K.

(j) Check the tensile stress in the reinforcement (including wind loading stresses) using the unity equation.

The tensile stress in the reinforcement, f_s , is determined as follows:

$$f_s = \frac{M_{tot}}{(A_{sT})(j)(d)}$$

$$= \frac{(232 \text{ in-k})(1000 \text{ lb/k})}{(3.00 \text{ in}^2)(0.815)(12 \text{ in})} = 7907 \text{ psi}$$

The allowable tensile stress in the reinforcement, F_s , is:

$$F_s = 24,000 \text{ psi (1.33)} = 32,000 \text{ psi}$$

$$f_s = 7907 \text{ psi} < F_s = 32,000 \text{ psi}$$

...O.K.

d. *Summary.* The nominal 16-inch by 16-inch pilaster with 6-#9 reinforcing bars is adequate.

CHAPTER 10

NONDESTRUCTIVE EVALUATION TECHNIQUES

10-1. Introduction. This chapter provides non-destructive evaluation (NDE) techniques for masonry in existing buildings. Techniques for both the evaluation of the condition of the materials and the determination of material properties are included.

10-2. Background. Traditional evaluation methods for the condition and properties of masonry features of buildings have been, in addition to visual inspection, destructive testing of specimens removed from the structure. Destructive methods of evaluation are inherently limited because specimen removal may be aesthetically and structurally damaging. Further, because of the potentially structurally destructive nature of these methods and the facts that they can be relatively expensive and aesthetically unpleasant, the number of specimens taken may be limited to a small number. Thus, potentially, the quantity and quality of the resulting data may be poor and/or inconsistent.

10-3. NDE methods. The use of NDE techniques can provide the structural engineer, who is charged with evaluating the structural integrity and serviceability of the masonry features of an existing structure, invaluable information. NDE methods can be used in conjunction either with each other or with destructive methods. The NDE methods described herein are those which offer the greatest potential at the present time for determining the location of flaws within masonry members and for assessing masonry materials properties.

10-4. Application of Combined Techniques. Combined NDE techniques. It is apparent that, of the methods described here, no single technique will be sufficient for "complete" nondestructive evaluation of masonry, where the term "complete" means comprehensive evaluation of both condition and quality. The mechanical tests, such as the flatjack, and in-place shear test, provide data directly related to quality, and perhaps indirectly a measure of condition. Conversely, impact and stress wave techniques evaluate condition and indirectly measure quality. Furthermore, the results from the latter techniques are often difficult to interpret in the absence of information about the state of stress that can be provided by the flatjack test. At the present time, therefore, the scenario for utilization of NDE techniques calls for use of two or more complimentary techniques for most

evaluation studies. Each technique must be used to its best advantage in combination with others to develop a body of evidence upon which conclusions and decisions may be made regarding existing conditions and rehabilitation measures required for masonry structures. Table 10-1 lists each NDE technique along the top and gives the desired information along the left side, which are grouped under the headings of material properties and condition. A simple matrix of dots indicates which techniques are useful for measuring each of the desired quantities. A filled dot indicates the technique is useful while an unfilled dot indicates that the technique is useful, but may be affected by conditions such as loading and crack distributions in the walls. Thus, the techniques with unfilled dots should be used in tandem with others to strengthen the reliability of the results.

10-5. NDE Tests.

a. Schmidt Hammer. The Schmidt Hammer test is the quickest, simplest, and least expensive method for NDE of solid clay unit, i.e., brick masonry. As shown in figure 10-1, studies show a reasonably good correlation between the rebound number and the compressive strength of clay brick masonry.

The Schmidt Hammer is most ideally suited to the measurement of material uniformity over large areas of a structure. It must be accompanied by a limited number of destructive tests to calibrate the results if an indication of the actual masonry strength is required. The simplicity of the test is offset by its limited utility. Its use is suggested only for determination of the uniformity of properties over a large area of a structure.

(1) *Equipment.* The Schmidt Hammer is a compact, lightweight instrument that provides a measure of relative material surface hardness. It has been used extensively in the testing of concrete and rock. The hammer consists of a spring loaded plunger which, when released, strikes a surface and causes a mass within the hammer to rebound. The magnitude of the rebound is indicated on a scale at the "rebound number". This number gives an indication of surface hardness which can be correlated to the strength or condition of the material. For the evaluation of solid clay (brick) masonry units, the hammer is pressed against the center of the vertical surface of an individual brick in a wall. The rebound number is a function of the brick hardness and the mortar in which the brick is

NONDESTRUCTIVE TESTING TECHNIQUES REQUIRED INFORMATION FOR STRUCTURAL EVALUATION		Schmidt Hammer	Single Flatjack	Double Flatjack	In-Plane Shear	Modified Shear Test	Ultrasonic Pulse	Mechanical Pulse	Magnetic Method	Visual
		MATERIAL PROPERTIES	Compressive Strength (Direct)			●				
Compressive Strength (Indirect)	●						○	○		
Deformability				●						
Joint Shear Strength					○	●				
Coulomb Shear Relationship						●				
CONDITION	Voids Between Wythes						●	●		
	Cracks in Outer Wythes						○	○		○
	In-Situ Stress		●							
	Material Uniformity	●					●	●		○
	Location of Reinforcement								●	

- Useful for evaluation
- Useful, but may require additional information regarding loading conditions and crack distributions

U. S. ARMY CORPS OF ENGINEERS

Table 10-1. Use of NDE methods.

embedded. Test hammers are available in four basic varieties; Type L, Type N, Type M, and Type P; which are distinguished primarily by their impact energy. The type N hammer has a tendency to crush the brick unit material under the tip, particularly for older, lightly burned units. For this reason, a type L hammer with lower impact energy is recommended to prevent damage to the masonry units.

(2) *Use.* The application of the Schmidt Hammer to concrete testing is governed by ASTM C 805. There is no standard at this time for the use of the Schmidt Hammer on masonry materials. An experimental procedure has been adopted for testing masonry structures which is based upon the International Society for Rock Mechanics (ISRM) suggested method for determining Schmidt rebound hardness. While laboratory tests have shown that a relationships may exist between rebound number and masonry compressive strength under controlled conditions, the general applicability of such a relationship has not been verified. Therefore, due to the wide variations in predicted strength, it is not recommended that the Schmidt Hammer be used for direct prediction of compressive strength,

but only for evaluation of material uniformity. The correlation to masonry compressive strength is useful primarily for determining the expected relative change in compressive strength between locations with different rebound numbers.

b. Flatjack methods. The flatjack test is being recognized as a powerful tool for NDE of the structural properties of masonry. ASTM standards are currently being established for the application of flatjack testing to the evaluation of unreinforced solid clay unit (brick) masonry. The test has been successfully applied to cut stone masonry. Under the proper conditions, flatjacks can provide information on the in-situ state of stress at virtually any point in a masonry structure. The test provides a measure of the deformability of the masonry materials and in some cases, a direct measure of masonry compressive strength. No other NDE test method offers direct physical measurement of material and structural properties without any reliance on empirical correlations. The two main types of flatjack tests; the in-situ stress or single-flat jack test and the in-situ deformability or two-flatjack test; are described in the following paragraphs:

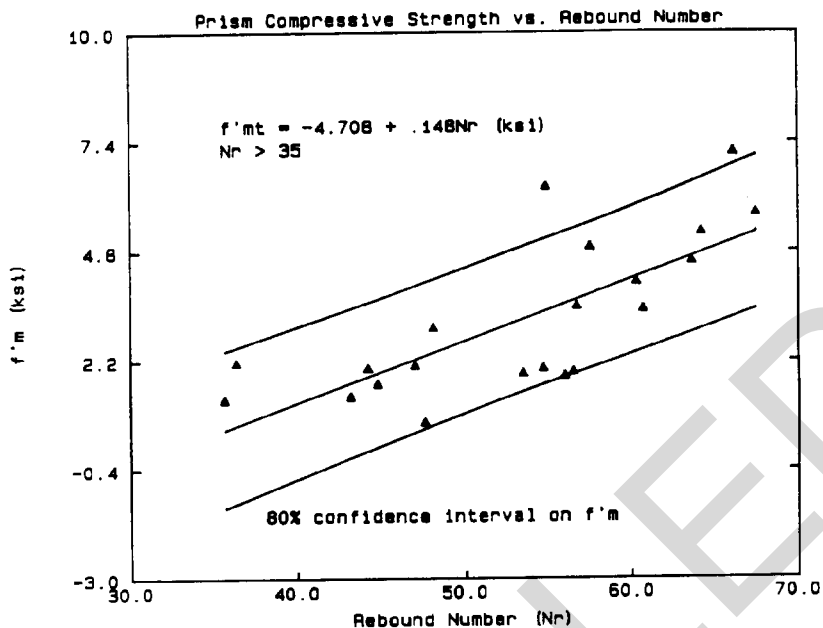

U. S. ARMY CORPS OF ENGINEERS

Figure 10-1. Prism compressive strength vs. rebound number.

(1) *In-situ stress test.* Evaluation of the in-situ compressive stress is a simple process of stress relief induced by the removal of a portion of a mortar bed joint followed by restoration of the original state of stress by pressurizing a flatjack inserted in the slot created by the removal of the mortar. When the mortar is removed from a horizontal joint, the release of the stress across the joint causes the slot to close by a small amount. The magnitude of this deformation is measured using a removable dial gauge between two or more points located symmetrically on either side of the slot. A flatjack is then inserted in the slot and pressurized until the original position of the measuring points is restored. At this point the pressure in the flatjack, modified by two constants to account for the flatjack stiffness and the area of the slot, is assumed equivalent to the original vertical compressive stress in the masonry. The technique is useful for verifying analytical models or for determining stress distributions in masonry walls when conditions of loading or displacement are unknown or difficult to quantify. Typical test results, as shown in figure 10-2, are a plot of masonry deformations around a slot for various levels of internal flatjack pressure. Past results show that the in-situ stress test is able to estimate the actual state of masonry compressive stress to within 10% to 15%.

(2) *In-situ deformability test.* The deformation properties of masonry may be evaluated by inserting two parallel flatjacks, one directly above the other separated by several courses of masonry, and pressurizing them equally, thus imposing a compressive load on the intervening masonry. The deformations of the masonry between the flatjacks are then measured for several increments of load. The results are used to calculate the masonry deformability modulus. If some damage to the masonry is acceptable, the masonry may be loaded to failure to determine the maximum strength. This technique is useful when an estimate of material deformability or strength is needed for stress analysis or deflection calculations. Test results in the form of a cyclic stress-strain curve along with the test setup are shown in figure 10-3. This in-situ deformability test provides a reasonably accurate measure of masonry compressive modulus, typically overestimating the masonry stiffness by approximately 10%.

(3) *Equipment.* A flatjack is a thin steel bladder that is pressurized with oil to apply a uniform stress over the plan area of the flatjack. In masonry structures, flatjacks are inserted in slots cut in mortar bed joints. Flatjacks may be made in many shapes and sizes. Flatjacks with curved edges are designed to fit in a slot cut by a circular masonry saw and rectangular jacks are used where

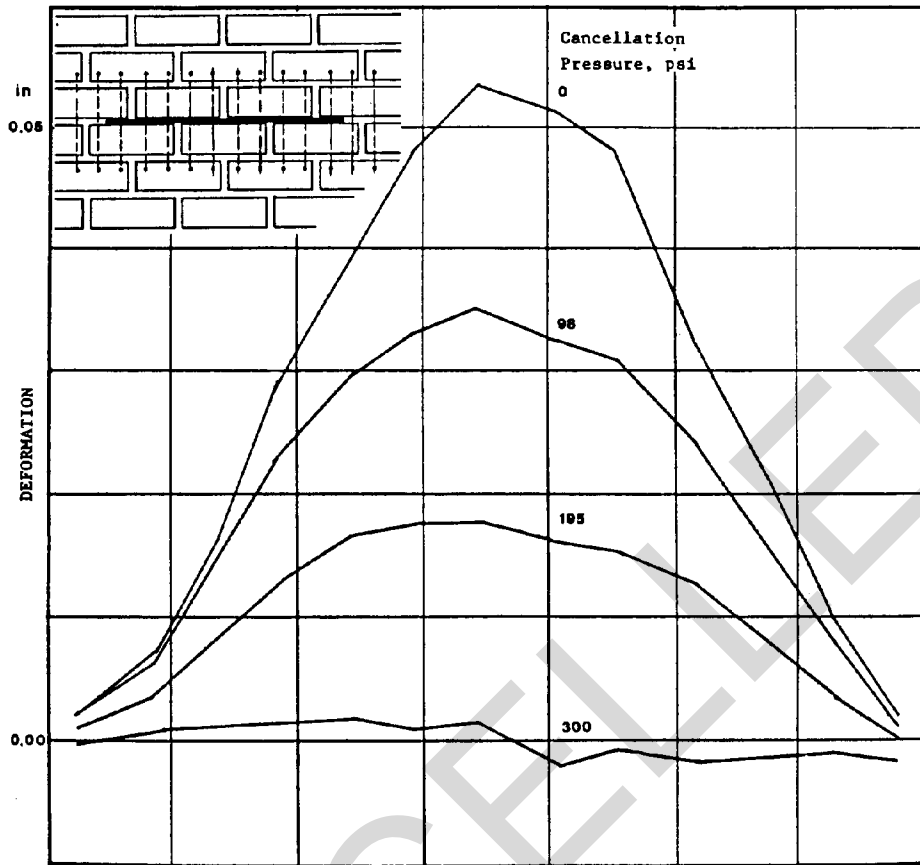

U. S. ARMY CORPS OF ENGINEERS

Figure 10-2. Masonry deformations around flatjack slot during in-situ stress test.

mortar must be removed by hand or with a drill. Semicircular jacks are suitable for in-situ stress measurement but are not suitable for deformation measurements in the two-flatjack test. Instead, rectangular or semi-rectangular flatjacks with a length equal to or greater than that of two masonry units should be used. An accurate, removable dial gauge is needed for measurement of displacements or, in the case of the two-flatjack test, electronic deformation measuring devices may be used. Other equipment required for the flatjack test includes a diamond-bladed masonry saw or a hand drill to form the slot at the chosen location, a hydraulic pump, flexible high pressure hoses, and a calibrated pressure gauge.

(4) *Application.* Flatjack tests are among the most useful and informative NDE tests available for determining masonry structural properties. Unlike other NDE tests, the flatjack test provides a direct physical measurement of the

engineering material characteristics needed for structural analysis and evaluation. It does not rely upon correlation to laboratory tests. The in-situ stress test provides a direct measure of the vertical stress at a point in a structure—thus gives an indication of the factor of safety of the structure in terms of compressive failure. The measurement of in-situ stress also provides a gauge of the accuracy of structural analyses in predicting the effects of gravity loads. The in-situ deformability test yields a direct measure of the compression modulus which can be used for calculation of deflections, or for use during structural analysis. It may also be possible, in certain cases, to estimate masonry compressive strength from an in-situ deformability test. The flatjack tests are not strictly NDE tests, since they do require the removal of a portion of a mortar joint. However, this damage is easily repaired by simply repointing mortar into the slot, leaving no visible trace of the test. The flatjack test

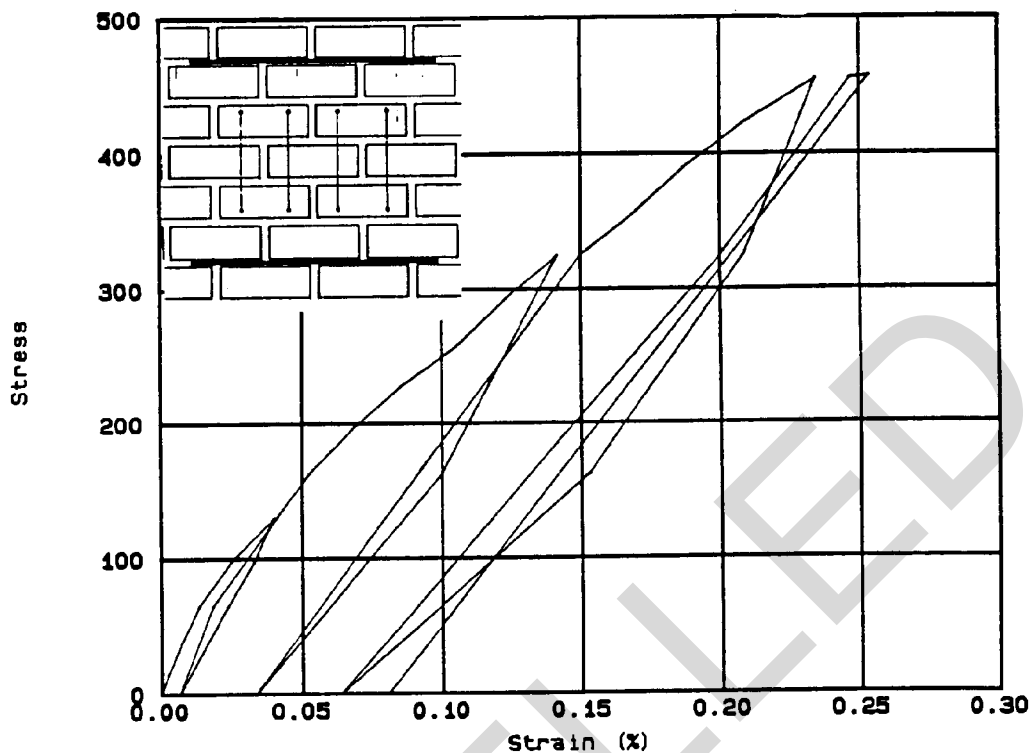

U. S. ARMY CORPS OF ENGINEERS

Figure 10-3. Stress-strain curve obtained during in-situ deformability test.

may be easily integrated into the structural evaluation process and provide data that is complimentary to other NDE tests. Data concerning the states of stress at various points throughout the structure may be very helpful in the interpretation of data from the in-place shear test and both ultrasonic and mechanical pulse tests. Data on the elastic modulus and strength of masonry obtained from the two-flatjack test may be used for correlation to Schmidt Hammer or pulse velocity tests.

c. In-situ shear test. The in-place shear test, often called the push test, is designed to measure the in-situ joint shear resistance between masonry units and mortar joints. It requires the removal of a single masonry unit and a head joint on opposite sides of a test unit. The test unit is then displaced horizontally relative to the surrounding masonry using a hydraulic jack and the horizontal force required to cause the first movement of the test unit is recorded. The test may be considered nondestructive, because the removed unit and mortar joints may be replaced to their former appearance.

(1) *Existing test.* The test procedure, as described in the model codes, is not very specific about the details of the test and about the analysis of the test data. A more complete description of

the test is contained in the ABK Methodology for Mitigation of Seismic Hazards in Existing Unreinforced Masonry Buildings. This shear test is the best currently available for measuring in-situ bed joint shear strength in existing masonry walls, however, several unknowns still must be accounted for by assumptions. The assumptions include, the definition of joint failure, the effect of normal load on the measured shear stress, the magnitude of the normal load on the tested joint, the contribution of the collar joint, the variability of the masonry due to workmanship in the original construction, and the correlation of the results to full-scale wall behavior. Each of these assumptions may introduce an element of inaccuracy into the determination of the available shear resistance of an existing masonry wall. These inaccuracies need to be considered if a more reliable method of determining the shear strength is to be obtained.

(2) *Modified test.* A modified technique for conducting the in-place shear test has been developed which addresses many of these assumptions and appears to give reliable results. In the modified test, the vertical stress in the wall at the test unit is measured directly using the single flatjack test. The normal stress is then controlled during the shear test by flatjacks above and below the test unit. The

test is then conducted on the same joint for several levels of normal stress, so the friction angle is measured directly rather than assumed. Electronic deformation measuring devices are used to monitor the movement of the unit continuously during the test, thus eliminating ambiguity concerning the definition of failure. The influence of the collar joint may be estimated based on a collar joint shear test. Only the effect of workmanship remains a potential source of error. The test setup for the modified in-place shear test is shown in figure 10-4. Results from this test show the relationship between increasing normal load and the resulting increasing deflection.

(3) *Application.* Because the in-place shear test measures the bed joint shear strength directly with a minimum of damage to the structure, it is an essential part of any building evaluation where lateral loads influence the building design. In some seismic regions, the existing test is required for some retrofit designs. The modified test should be conducted as an extension of a normal series of flatjack tests. The single-flatjack test reveals the in-situ state of normal stress at the test joint, and thus provides essential data for determining the expected joint shear strength in the area of the test. The two-flatjack test provides half of the required test setup for the modified in-place shear test. At the completion of the test, the engineer should know the relationship between the expected joint shear strength and the normal stress along with the measured normal stress at the test location. If similarity of materials throughout the structure can be established using a technique such as the Schmidt Hammer test, the number of required in-place shear tests can be reduced from the number

determined by arbitrary methods, such as a certain number of tests per square foot, etc. It remains only to conduct the simpler single flatjack test to determine the variation of normal stresses throughout the structure.

d. Ultrasonic Pulse. The ultrasonic pulse velocity (UV) technique uses electroacoustic transducers to pass a high frequency (50,000 Hz) stress wave through masonry. This technique has good potential for evaluation of masonry structures and is most useful for the location of relatively small flaws in otherwise uniform masonry materials. In certain cases, it may be possible to obtain an estimate of masonry compressive strength from ultrasonic pulse velocity measurements. However, very careful interpretation of the signal is required along with a meticulous visual survey in order to interpret the data properly. It is recommended that pulse velocity techniques be used in conjunction with other NDE tests such as the flatjack test for determining the state of stress and deformability in walls and also with destructive tests to verify the deformability and strength.

(1) *Background.* The ultrasonic pulse velocity technique has only recently been applied to masonry. The studies to date have been mostly exploratory, evaluating the feasibility of using the method on masonry structures. The technique has been used effectively for concrete using ASTM C 597 for quite some time, hence the literature on testing concrete using ultrasonic pulse velocity techniques is extensive. The method has proven to be reasonably accurate for predicting concrete compressive strength using empirical relationships that were derived under carefully controlled laboratory conditions. However, a multitude of factors

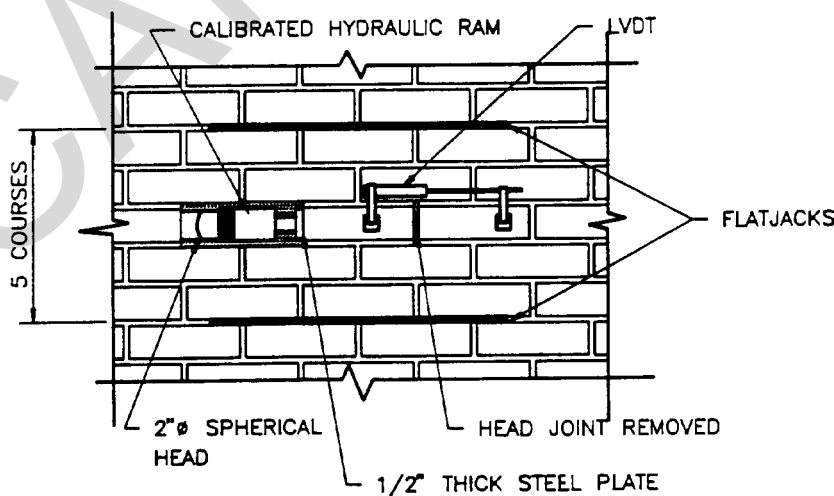

U. S. ARMY CORPS OF ENGINEERS

Figure 10-4. Setup for modified in-place shear test.

have been shown to influence ultrasonic measurements in concrete; including, among others; aggregate type and size, moisture content, and the presence of reinforcement. Generally, those factors which can affect compressive strength may also affect ultrasonic pulse velocity, though not necessarily in direct proportion. Strength predictions can only be justified if a calibration of pulse velocity with masonry strength is made for the specific structure under consideration, and then only if the conditions of testing can be carefully controlled. The empirical relationship between ultrasonic pulse velocity and masonry compressive strength must, in effect, be established for every structure evaluated. Because of this limitation, the pulse velocity method is generally used only to measure material uniformity over a large area of a structure.

(2) *Equipment.* Equipment needed for ultrasonic investigations consists of two transducers (transmitter and receiver), transducer leads, and a power unit with digital transit time display. A transient wave recorder can also be useful to provide hard copy records of the signals. These records can then be fed into a portable computer for more sophisticated analysis of the signals.

(3) *Experimental procedure.* Two types of tests are typically conducted: (a) Direct (or

through-wall) tests in which the sending and receiving transducers are placed in line with one another on opposite sides of the test wall; and (b) Indirect tests in which the transducers are located on the same face of the wall in a vertical or horizontal line. These test configurations are illustrated in figure 10-5. The simplest way to utilize ultrasonic wave transmission data is to simply record the arrival time and the pathlength and calculate an average velocity for the pulse. The determination of arrival time is simplified by the use of a digital readout on the device. If the digital readout is not used, it is possible to analyze the wave trace to determine the arrival time. Data may then be displayed in any of several forms including x-y plots of pulse path length versus pulse travel time, contour maps of arrival time, or contour maps of pulse transmission quality.

(4) *Indirect tests.* Indirect tests are useful for determining the average velocity through a single outer wythe of masonry, and for locating flaws in the outer wythes. A distinct flaw, such as a delaminated bed joint, will cause a reduction in the pulse velocity in the vicinity of the flaw. Hence, an area of lesser quality material can be expected to have a slower pulse velocity. Clay brick masonry, if built with weak mortar and low strength units, may attenuate the high frequency stress wave to the

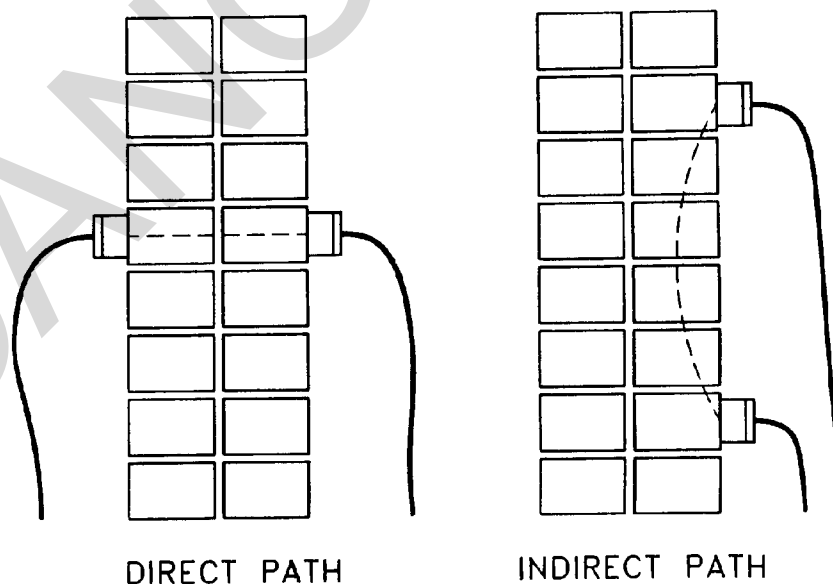

U. S. ARMY CORPS OF ENGINEERS

Figure 10-5. Typical ultrasonic test configurations.

point where the distance between transducers is very small, such as one foot, and reduce the usefulness of the method.

(5) *Direct (through-wall) tests.* Figure 10-6 shows a three dimensional surface representing the variation in ultrasonic pulse arrival time over the area of a masonry wall. The vertical dimension is the arrival time, so humps on the plot indicate areas of relatively long arrival time and thus areas of potential voids. The test wall in figure 10-6 was constructed with known flaws in the masonry. While the exterior wythes of this wall were constructed of uniform quality, the interior wythe had varying materials and workmanship. In general, the highest quality materials were located in the lower courses of the interior wythe, and the quality deteriorated with increasing height in the wall. The most significant flaw was an air space in the upper right portion of the wall. The location of the air space in the interior wythe is clearly outlined in both the contour and surface plots. The less dramatic changes in material quality over the height of the wall are apparent as small changes in arrival time between the top and bottom halves of the wall.

(6) *Application.* While the use of ultrasonic techniques has been successful for the evaluation of concrete, the method is less well suited to heterogeneous materials such as masonry. The attenuation of a stress wave is related to its wavelength and the size of the largest flaws in its path. As the relatively short wavelength of the ultrasonic pulse passes through each mortar joint, the pulse suffers considerable energy loss, resulting in extremely rapid signal attenuation. This attenuation inhibits the use of ultrasonics over all but the shortest pathlengths. Because of the limitations of the ultrasonic method applied to masonry, lower frequency sonic testing (1 to 5 kHz) (a.k.a. “mechanical pulse testing”) should be used in NDE techniques for masonry structures.

e. Mechanical pulse. This method, called “Mechanical Pulse Velocity” testing, involves input of a stress wave into a masonry wall by means of a hammer blow, and recording of the subsequent vibrations with an accelerometer. This technique, due to its low frequency, high-amplitude, long-wavelength signal, is better suited to the evaluation of masonry than the ultrasonic technique. As with ultrasonic testing, the quantity of interest has traditionally been the arrival time of the pulse,

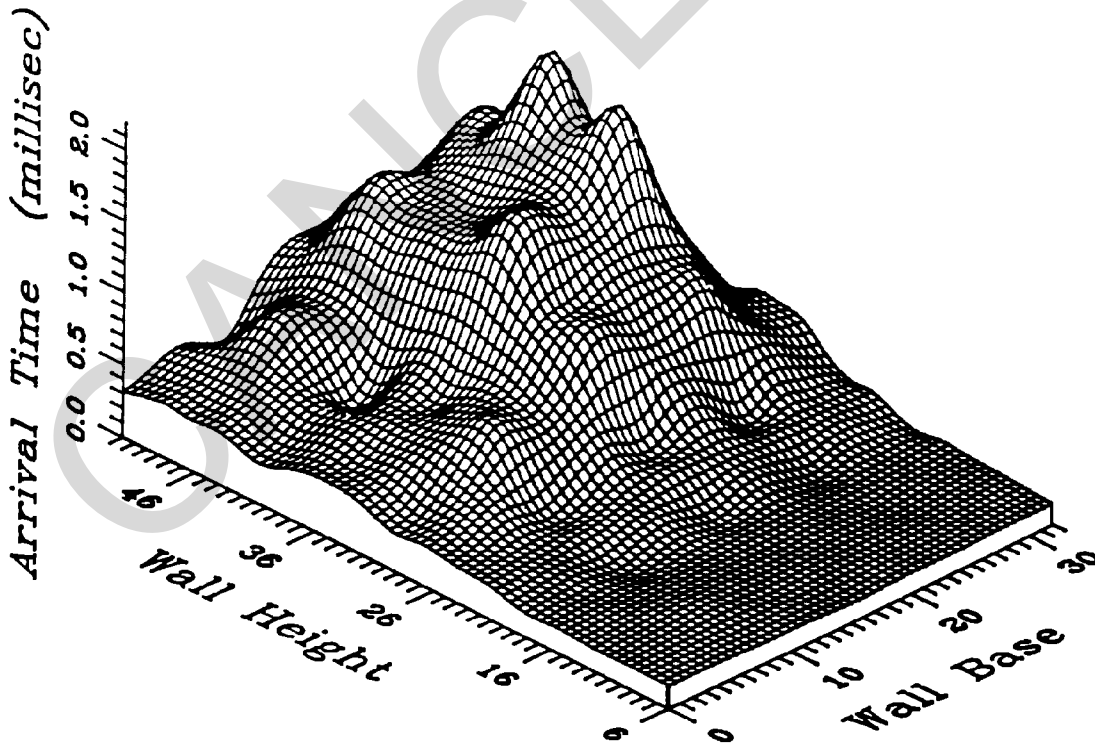

U. S. ARMY CORPS OF ENGINEERS

Figure 10-6. Three-dimensional surface representing through-wall ultrasonic pulse arrival time.

which, in conjunction with the pathlength, gives a simple indication of pulse velocity. The pulse velocity can, to various degrees of accuracy, be correlated with material properties. In addition, sonic techniques can be used to locate material flaws, however, the long wave length that makes a sonic pulse appropriate for testing long expanses of brick work also increases the minimum size flaw that can be detected.

(1) *Equipment.* The basic equipment used for conducting mechanical pulse tests includes a 3 pound modally tuned hammer and an accelerometer. Unlike the ultrasonic test equipment, there is no digital readout of travel time with this equipment, so the signal must be recorded or displayed on an external device. A digital transient recorder can be used to record both the hammer input signal and the accelerometer output signals. The signals can then be saved on floppy disks through a portable computer. The testing apparatus is shown in figure 10-7. Alternatively, an oscilloscope may be used to measure travel time.

(2) *Use.* Test results for mechanical pulse tests are much the same as those for ultrasonic

pulse velocity as described previously. The simplest way to utilize mechanical wave transmission data is to simply record the arrival time and the pathlength and calculate an average velocity for the pulse. The recorded data should then be plotted in some understandable format. Two dimensional contours or three dimensional surface plots are recommended for direct tests, and x-y plots are recommended for indirect tests. Figure 10-8 plots the pulse path length against the arrival time for an indirect mechanical pulse test. The presence of a distinct flaw causes a noticeable break in the velocity line.

(3) *Application.* The mechanical pulse technique is best suited to the task of locating flaws and discontinuities such as missing mortar joints and large cracks and establishing relative quality of masonry from one location to another. Indirect tests are useful for determining the average velocity through a single outer wythe of masonry, and for locating flaws in the outer wythes. Direct tests are able to locate flaws and voids in interior wythes and collar joints. The mechanical pulse technique is superior to the ultrasonic system for flaw detection

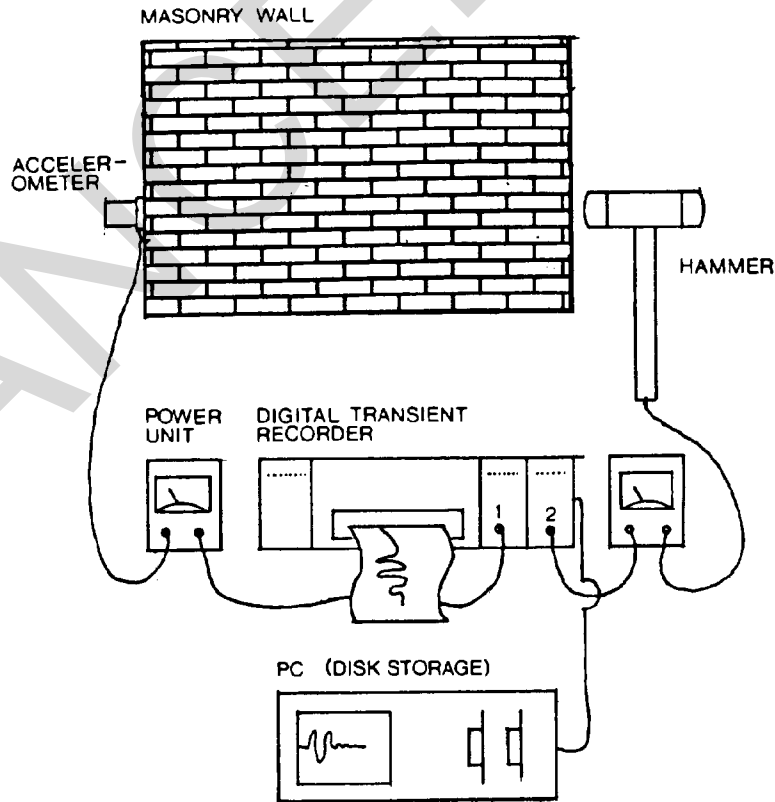

U. S. ARMY CORPS OF ENGINEERS

Figure 10-7. Mechanical pulse testing apparatus.

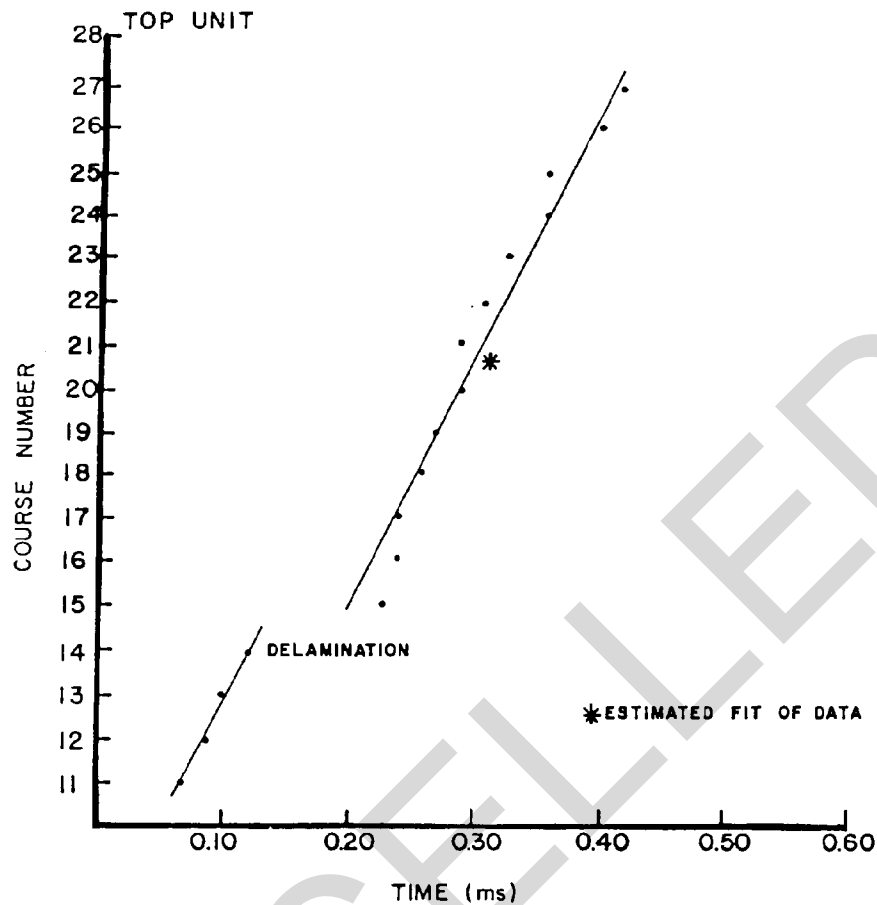

U. S. ARMY CORPS OF ENGINEERS

Figure 10-8. Pulse path length vs. arrival time.

and condition assessment in masonry structures particularly in the case of older unreinforced brick masonry. The primary difference between the two techniques is the amplitude and wavelength of the input pulse, both of which are larger for the mechanical pulse tests. The high energy and long wavelength of its input wave are not as rapidly attenuated by the boundaries between units and mortar that are intrinsic parts of masonry construction. Because of this, the mechanical pulse will travel farther through most masonry materials than the ultrasonic pulse. In addition, the mechanical pulse technique is sensitive enough to detect larger flaws that are of interest in a structural evaluation. Thus, for masonry, the mechanical pulse system is generally preferable to the ultrasonic system. Because of potential difficulties in the interpretation of data, mechanical pulse tests are best conducted in conjunction with flatjack tests, so that the influence of varying vertical stresses and varying material deformability on the mechanical pulse measurements can be assessed. The single case where the ultrasonic pulse is

preferable to the mechanical pulse is when the desired path length is very short and the quality of the masonry is generally good, as in through-wall transmission tests in grouted concrete masonry. In this case, the mechanical pulse system is unable to detect the typically small flaws or delaminations.

f. *Location of reinforcement and ties.* The use of magnetic and resistance methods allows quick inspection of masonry construction for the presence of steel reinforcement or ties. These techniques may be useful for quality control as a means of verifying compliance with construction plans, and provide reasonable results when expected reinforcing bar sizes and locations are known. More difficult is the case of retrofit or renovation projects, when it is necessary to not only locate the reinforcement, but also estimate the size and depth to the bar. Commercially available equipment typically utilizes an electromagnetic field generated around a hand-held probe to indicate the presence of steel in the masonry. A voltage change occurs when the field is interrupted by a ferrous material, such as a steel reinforcing bar. The magnitude of

the voltage change is proportional to the amount of steel and the distance from the steel to the probe. The application of the test is done by cover meters used to locate the presence of vertical and horizontal reinforcement, joint reinforcement, and metal ties or connectors. The equipment is compact and portable, allowing the operator to quickly map reinforcing locations and patterns. Cover meters will, however, locate all steel present, not just the reinforcing bars. Some care needs to be taken not to identify metal ties, nails, electrical conduit, etc., as reinforcing steel. While cover meters are able to accurately determine the presence of reinforcing steel, some interpretation is needed if either the size of the reinforcement or the depth within the masonry is to be estimated. A weak signal can indicate either a small bar close to the surface, or a larger bar located farther from the probe. Hence, it may be necessary to expose the reinforcement at trial locations to verify assumptions regarding size and location.

g. *Nuclear methods.* Although not related directly to structural properties of materials, the Neutron-Gamma technique shows great promise for certain aspects of masonry evaluation. The technique measures element concentrations in masonry walls, and thus gives information about moisture content, presence of salts, and elemental composition of the masonry materials. The technique has been shown to be complementary to structural evaluation techniques by aiding the interpretation of results from tests such as the mechanical pulse technique.

10-6. Advantages and disadvantages of all NDE tests.

a. *Schmidt Hammer test.*

(1) *Advantages.*

(a) Simple to use. No special experience is needed to conduct the test.

(b) Establishes uniformity of properties.

(c) Equipment is inexpensive and is readily available. It is relatively simple and inexpensive to conduct a large number of tests. The equipment for the test is readily available.

(2) *Disadvantages.*

(a) Evaluates only the local point and layer (wythe) of masonry to which it is applied.

(b) No direct relationship to strength or deformation properties.

(c) Unreliable for the detection of flaws.

(d) Evaluates only the layer (wythe) of masonry to which it is applied, and is unreliable for detection of flaws or for investigation of inaccessible masonry wythes.

b. *Single Flatjack in-situ stress test.*

(1) *Advantages.*

(a) Can establish the state of compressive stress, in-situ, with reasonable accuracy.

(b) Inexpensive materials and equipment.

(c) Uncomplicated to use.

(d) ASTM standards currently being developed.

(2) *Disadvantages.*

(a) Somewhat time-consuming to prepare the test, when compared to other methods.

(b) Requires removal of mortar from masonry bed joint with a saw or drill.

(c) Requires repair of the mortar joint after testing.

c. *Double Flatjack in-situ deformability test.*

(1) *Advantages.*

(a) Can establish deformation properties, in-situ, with reasonable accuracy.

(b) Inexpensive materials and equipment.

(c) Uncomplicated to use.

(d) ASTM standards currently being developed.

(2) *Disadvantages.*

(a) Somewhat time consuming to prepare the test, when compared to other methods.

(b) Requires removal of mortar from masonry bed joint with a saw or drill.

(c) Requires repair of the mortar joint after testing.

d. *In-place shear test.*

(1) *Advantages.*

(a) Can establish joint shear strength in-situ.

(b) Equipment is inexpensive and readily available.

(c) Uncomplicated to use.

(2) *Disadvantages.*

(a) Somewhat time consuming to prepare.

(b) Requires removal of a masonry unit and a head joint.

(c) Restricted to masonry with low cement content mortar.

(d) Requires unit and mortar replacement after the test.

(e) State of compressive stress on the test unit must be estimated.

(f) Contribution of the collar joint is unknown.

e. *Two Flatjack modified in-place shear test.*

(1) *Advantages.*

(a) Can establish the joint shear strength in-situ with reasonable accuracy.

(b) Permits control of compressive stress on test unit.

(c) Determines the Coulomb failure surface for the material.

TM 5-809-3/NAVFAC DM-2.9/AFM 88-3, Chap. 3

(2) *Disadvantages.*

(a) Somewhat time consuming to prepare.

(b) Requires removal of two masonry units.

(c) Restricted to masonry with low cement-content mortar.

(d) Requires unit replacement after the test.

(e) Contribution of collar joint is unknown.

(f) Requires removal and replacement of two mortar joints.

(g) Large amount of equipment is required.

f. *Ultrasonic pulse velocity.*

(1) *Advantages.*

(a) Simple to use.

(b) Establishes uniformity of properties.

(c) Can detect flaws, cracks, or voids.

(d) Possible to record trace of stress wave for analysis.

(e) Equipment readily available and only moderately expensive.

(f) Equipment package is self contained and portable.

(2) *Disadvantages.*

(a) Requires access to both sides of a wall for direct measurements.

(b) Attenuation of signal in older or soft masonry restricts distance between transducers for indirect and semi-direct use.

(c) Coupling material needed between masonry and transducers, which may alter the appearance of the masonry.

(d) Grinding may be required to prepare a rough surface.

(e) No direct correlation with material properties.

g. *Mechanical pulse velocity.*

(1) *Advantages.*

(a) Reasonably simple to use.

(b) Establishes uniformity of properties.

(c) Can detect flaws, cracks, and voids.

(d) Possible to record trace of stress wave for later analysis.

(e) Equipment is readily available and only moderately expensive.

(f) Capable of testing over long distances in any type of masonry.

(g) Does not damage the masonry.

(2) *Disadvantages.*

(a) Several pieces of equipment are involved, not easily portable.

(b) Requires a separate instrument to record the wave arrival time.

(c) No direct correlation between results and material properties.

(d) Analysis of the wave trace can be complicated.

h. *Magnetic methods.*

(1) *Advantages.*

(a) Equipment is portable and inexpensive.

(b) Large areas of masonry can be quickly evaluated.

(c) Accurately maps location and orientation of reinforcing steel in masonry.

(d) Can be used to locate metal ties and connectors.

(2) *Disadvantages.*

(a) Readings can be ambiguous, requiring operator interpretation or destructive tests to verify conclusions.

(b) Misidentification of metal conduit, etc., as reinforcing steel is possible.

(c) Accuracy in determination of bar size and depth is questionable.

APPENDIX A REFERENCES

Government Publications.

Departments of the Army, Navy and the Air Force

TM 5-809-1/AFM
88-3, Chap. 1 Load Assumptions for Buildings

TM 5-809-2/AFM
88-3, Chap. 2 Structural Design Criteria for Buildings

TM 5-809-10/
NAVFAC P355/
AFM 88-3,
Chap. 13 Seismic Design for Buildings

Non-Government Publications.

American Concrete Institute (A CI): Publications, Box 19150, Redford Station, Detroit, MI 48219

ACI 318-89 Building Code Requirements for Reinforced Concrete

ACI 530-88 Building Code Requirements for Masonry Structures

American Institute of Steel Construction (AISC): Publication, 101 Park Avenue, New York, NY 60611

Manual of Steel Construction, Ninth Edition, 1989

American Society for Testing and Materials (AS TM): Publications, 1916 Race Street, Philadelphia, PA 19103

C 55-85 Concrete Building Brick

C 62-89a Building Brick

C 67-90a Sampling and Testing Brick and Structural Clay Tile

C 90-90 Load-bearing Concrete Masonry Units

C 91-89 Masonry Cement

C 109-90 Test Methods for Compressive Strength of Hydraulic Cement Mortars
(Using 2-in, or 50-Micrometer Cube Specimens)

C 140-90 Methods of Sampling and Testing Concrete Masonry Units

C 144-89 Specification for Aggregate for Masonry Mortar

C 150-89 Specification for Portland Cement

C 207-84 Specification for Hydrated Lime for Masonry Purposes

C 216-90a Facing Brick (Solid Masonry Units Made From Clay or Shale)

C 270-89 Mortar for Unit Masonry

C 426-88 Test Methods for Drying Shrinkage of Concrete Block

C 476-83 Grout for Masonry

C 595-89 Specification for blended Hydraulic Cements

C 597-83 Test Method for Pulse Velocity Through Concrete

C 652-89a Specification for Hollow Brick (Hollow Masonry Units Made From Clay
or Shale)

TM 5-809-3/NAVFAC DM-2.9/AFM 88-3, Chap. 3

C 805-85	Test Methods for Rebound Number of Hardened Concrete
C 1019-89	Method of Sampling and Testing Grout
C 1072-86	Measurement of Masonry Flexural Bond Strength
E 111-88	Test Methods for Young's Modulus, Tangent Modulus and Chord Modulus
E 72-80	Method for Conducting Strength Tests of Panels for Building Construction
E 447-84	Test Methods for Compressive Strength of Masonry Prisms
E 5 18-87	Test Method for Flexural Bond Strength of Masonry
E 5 19-88	Flexural Diagonal Tension (Shear) in Assemblages

International Society for Rock Mechanics: Laboratório Nacional de Engenharia Civil, 101 Ave. do Brasil, P-1770 Lisboa Codex, Portugal

"Suggested Methods for Rock Stress Determination," *Int. J. Rock Mech. Mi Sci. & Geomech. Abstr.*, Vol 24, No. 1, pp. 53-73, 1987.

The Masonry Society: 2619 Spruce Street, Suite B, Boulder, Colorado 80302.

Livingston, R. A., "X-Ray Analysis of Brick Cores from the Powell-Wailer Smokehouse, Colonial Williamsburg," *Proceedings of the Third North American Masonry Conference*, Arlington, Texas, June 1985.

ABK, A Joint Venture, "Methodology For Mitigation of Seismic Hazards in Existing Unreinforced Masonry Buildings: Diaphragm Testing," *Topical Report 03*, Dec. 1981

National Concrete Masonry Association (NCMA): Publications, 1800 North Kent Street, Arlington, Va 22209

Engineered Concrete Masonry-Wind Loads (1970) (TEK 24)

Frey, Donald J., "Effects of Constituent Proportions on Uniaxial, Compression Strength of 2-inch Cube Specimens of Masonry Mortars", M. S. Thesis, University of Colorado-Boulder, 1975.

APPENDIX B

DESIGN AIDS FOR REINFORCED MASONRY WALLS

B-1. Purpose. This appendix contains design aids that may be used in the design of reinforced masonry walls. Table B-1 through B-14 provide the properties of wall stiffeners with varying reinforcement, wall thickness and mortar type. Table B-15 through B-50 provide reinforcing steel spacing for varying wall heights, lateral loads, wall thickness, axial load, bar size and eccentricity. The values in the tables were determined using a T-section analysis when applicable.





$b_w=7.5$ in., $d=2.81$ in., $t'=1.00$ in. $n=29000/f'_m$, $F_m=0.33f'_m$ psi, $F_s=24000$ psi Increase M_r by 1/3 for wind or seismic load.		6 in. CMU $f'_m=1350$ psi Type S Mortar				
Stiffener	b in.	bar #	kd in.	I in ⁴	M_r Mas ft.-lb.	M_r Steel ft.-lb.
	36	3	.55	14.07	967	578
		4	.71	23.24	1231	1030
		5	.85	32.95	1452	1566
		6	.98	42.95	1643	2185
	32	3	.57	13.83	903	576
		4	.74	22.73	1145	1025
		5	.89	32.07	1346	1558
		6	1.03	41.60	1520	2172
	24	3	.65	13.22	761	570
		4	.84	21.41	956	1012
		5	1.00	29.82	1116	1535
		6	1.15	38.19	1245	2142
	16	3	.78	12.27	593	561
		4	.99	19.41	736	992
		5	1.17	26.44	845	1504
		6	1.34	33.15	927	2100
	8	3	1.03	10.40	380	543
		4	1.28	15.65	457	954
		5	1.49	20.40	514	1437
		6	1.66	24.65	558	1992

Table B-1. Properties of Wall Stiffeners With One Reinforcing Bar in Each Reinforced Cell, 6 in CMU, Type S Mortar.







$b_w=7.5$ in., $d=3.81$ in., $t'=1.25$ in. $n=29000/f'_m$, $F_m=0.33f'_m$ psi, $F_s=24000$ psi Increase M_r by 1/3 for wind or seismic load.					8 in. CMU $f'_m=1350$ psi Type S Mortar	
Stiffener	b in.	bar #	kd in.	I in ⁴	M_r Mas ft.-lb.	M_r Steel ft.-lb.
	48	4	.74	46.98	2377	1425
		5	.90	68.06	2840	2176
		6	1.04	90.52	3252	3047
		7	1.19	115.44	3647	4097
	40	4	.80	45.75	2135	1417
		5	.97	65.88	2541	2161
		6	1.13	87.12	2901	3022
		7	1.28	110.46	3242	4061
	32	4	.89	44.15	1869	1406
		5	1.07	63.06	2214	2141
		6	1.23	82.76	2516	2991
		7	1.40	104.10	2789	4021
	24	4	1.00	41.92	1568	1390
		5	1.20	59.19	1845	2114
		6	1.39	76.82	2078	2951
		7	1.57	95.45	2275	3973
	16	4	1.19	38.48	1216	1366
		5	1.42	53.29	1411	2073
		6	1.63	67.86	1562	2897
		7	1.83	82.66	1690	3895
	8	4	1.56	31.87	767	1317
		5	1.82	42.42	872	1988
		6	2.05	52.17	955	2759
		7	2.25	61.57	1025	3683

Table B-2. Properties of Wall Stiffeners With One Reinforcing Bar in Each Reinforced Cell, 8 in CMU, Type S Mortar.







$b_w=7.5$ in., $d=4.81$ in., $t'=1.375$ in. $n=29000/f'_m$, $F_m=0.33f'_m$ psi, $F_s=24000$ psi Increase M_T by 1/3 for wind or seismic load.					10 in. CMU $f'_m=1350$ psi Type S Mortar	
Stiffener	b in.	bar #	kd in.	I in ⁴	M_T Mas ft.-lb.	M_T Steel ft.-lb.
	48	4	.84	77.20	3435	1812
		5	1.02	112.63	4121	2770
		6	1.19	150.82	4739	3883
		7	1.36	193.66	5336	5228
	40	4	.91	75.39	3091	1802
		5	1.11	109.40	3696	2753
		6	1.29	145.73	4237	3854
		7	1.47	186.13	4749	5188
	32	4	1.01	73.03	2711	1789
		5	1.22	105.19	3228	2730
		6	1.42	139.16	3684	3818
		7	1.62	176.39	4089	5144
	24	4	1.15	69.72	2282	1771
		5	1.38	99.37	2701	2697
		6	1.60	130.10	3048	3774
		7	1.83	162.97	3342	5089
	16	4	1.36	64.55	1779	1743
		5	1.64	90.39	2071	2652
		6	1.89	116.21	2301	3711
		7	2.15	142.88	2496	4994
	8	4	1.80	54.46	1134	1685
		5	2.12	73.53	1299	2548
		6	2.40	91.58	1431	3538
		7	2.65	109.41	1546	4726

Table B-3. Properties of Wall Stiffeners With One Reinforcing Bar in Each Reinforced Cell, 10 in CMU, Type S Mortar.







$b_w=7.5$ in., $d=5.81$ in., $t'=1.5$ in. $n=29000/f'_m$, $F_m=0.33f'_m$ psi, $F_s=24000$ psi Increase M_r by 1/3 for wind or seismic load.					12 in. CMU $f'_m=1350$ psi Type S Mortar	
Stiffener	b in.	bar #	kd in.	I in ⁴	M_r Mas ft.-lb.	M_r Steel ft.-lb.
	48	4	.93	115.18	4623	2199
		5	1.14	168.94	5564	3367
		6	1.33	227.34	6417	4723
		7	1.52	293.40	7247	6365
	40	4	1.01	112.72	4165	2189
		5	1.23	164.50	4998	3347
		6	1.44	220.31	5747	4691
		7	1.64	282.91	6454	6322
	32	4	1.12	109.49	3659	2174
		5	1.36	158.70	4373	3321
		6	1.58	211.19	5006	4651
		7	1.81	269.23	5563	6274
	24	4	1.27	104.94	3088	2154
		5	1.54	150.64	3669	3284
		6	1.80	198.49	4147	4603
		7	2.06	250.22	4555	6212
	16	4	1.52	97.80	2416	2122
		5	1.84	138.07	2821	3234
		6	2.13	178.83	3142	4530
		7	2.43	221.50	3418	6101
	8	4	2.02	83.67	1552	2056
		5	2.39	114.18	1788	3113
		6	2.72	143.61	1980	4326
		7	3.02	173.19	2149	5783

Table B-4. Properties of Wall Stiffeners With One Reinforcing Bar in Each Reinforced Cell, 12 in CMU, Type S Mortar.







$b_w=7.5$ in., $d=5.31$ in., $t'=1.25$ in. $n=29000/f'_m$, $F_m=0.33f'_m$ psi, $F_s=24000$ psi Increase M_T by 1/3 for wind or seismic load.		8 in. CMU $f'_m=1350$ psi Type S Mortar				
Stiffener	b in.	bar #	kd in.	I in ⁴	M_T Mas ft.-lb.	M_T Steel ft.-lb.
	48	3	.68	55.68	3091	1119
		4	.89	95.21	4014	2005
		5	1.08	139.31	4824	3068
		6	1.26	187.04	5555	4303
		7	1.45	240.71	6219	5808
	40	3	.74	54.75	2793	1114
		4	.97	93.09	3614	1995
		5	1.17	135.49	4329	3050
		6	1.37	180.99	4958	4276
		7	1.58	231.52	5499	5777
	32	3	.81	53.52	2463	1108
		4	1.07	90.30	3173	1982
		5	1.29	130.51	3784	3025
		6	1.52	173.06	4283	4246
		7	1.75	219.49	4706	5739
	24	3	.93	51.77	2090	1100
		4	1.21	86.39	2674	1962
		5	1.47	123.55	3150	2996
		6	1.73	161.95	3519	4207
		7	1.99	202.88	3832	5682
	16	3	1.11	48.98	1650	1087
		4	1.45	80.25	2079	1934
		5	1.76	112.62	2401	2953
		6	2.05	144.95	2655	4136
		7	2.33	178.35	2872	5569
	8	3	1.50	43.30	1082	1058
		4	1.92	68.20	1334	1871
		5	2.27	92.56	1532	2831
		6	2.57	115.84	1692	3932
		7	2.85	139.05	1832	5254

Table B-5. Properties of Wall Stiffeners With Two Reinforcing Bars in Each Reinforced Cell, 8 in CMU, Type S Mortar.







		$b_w=7.5$ in., $d=7.06$ in., $t'=1.375$ in. $n=29000/f'_m$, $F_m=0.33f'_m$ psi, $F_s=24000$ psi Increase M_r by 1/3 for wind or seismic load.			10 in. CMU $f'_m=1350$ psi Type S Mortar	
Stiffener	b in.	bar #	kd in.	I in ⁴	M_r Mas ft.-lb.	M_r Steel ft.-lb.
	48	4	1.04	173.70	6274	2686
		5	1.27	256.02	7573	4115
		6	1.49	346.15	8740	5781
		7	1.72	448.39	9760	7822
		8	1.97	559.15	10619	10237
	40	4	1.13	170.32	5658	2673
		5	1.38	249.88	6811	4093
		6	1.62	336.24	7790	5753
		7	1.88	433.04	8624	7788
		8	2.16	536.59	9324	10192
	32	4	1.25	165.86	4979	2657
		5	1.52	241.82	5952	4067
		6	1.80	323.09	6725	5721
		7	2.10	412.76	7382	7743
		8	2.40	507.18	7935	10127
	24	4	1.42	159.57	4210	2635
		5	1.74	230.35	4951	4035
		6	2.06	304.46	5531	5674
		7	2.39	384.56	6027	7671
		8	2.72	467.25	6450	10016
	16	4	1.71	149.53	3275	2603
		5	2.10	212.14	3789	3982
		6	2.46	275.78	4201	5584
		7	2.82	342.77	4561	7523
		8	3.16	410.30	4874	9787
	8	4	2.28	129.65	2135	2524
		5	2.71	178.69	2471	3826
		6	3.09	226.81	2751	5322
		7	3.45	275.98	3000	7117
		8	3.78	324.28	3218	9202

Table B-6. Properties of Wall Stiffeners With Two Reinforcing Bars in Each Reinforced Cell, 10 in CMU, Type S Mortar.







$b_w=7.5$ in., $d=8.81$ in., $t'=1.5$ in. $n=29000/f_m'$, $F_m=0.33f_m'$ psi, $F_s=24000$ psi Increase M_r by 1/3 for wind or seismic load.		12 in. CMU $f_m'=1350$ psi Type S Mortar				
Stiffener	b in.	bar #	kd in.	I in. ⁴	M_r Mas ft.-lb.	M_r Steel ft.-lb.
	48	4	1.17	276.40	8863	3368
		5	1.43	409.48	10731	5166
		6	1.68	556.29	12390	7268
		7	1.96	723.94	13821	9846
		8	2.26	906.84	15028	12896
	40	4	1.27	271.56	8003	3354
		5	1.55	400.64	9661	5141
		6	1.84	541.81	11038	7238
		7	2.15	701.23	12212	9808
		8	2.48	873.16	13201	12843
	32	4	1.41	265.17	7054	3336
		5	1.73	388.93	8439	5113
		6	2.06	522.46	9530	7202
		7	2.41	671.08	10461	9756
		8	2.76	829.08	11252	12765
	24	4	1.61	256.10	5972	3311
		5	1.99	372.14	7022	5078
		6	2.36	494.88	7849	7148
		7	2.75	628.96	8563	9670
		8	3.14	768.99	9180	12630
	16	4	1.95	241.47	4650	3276
		5	2.40	345.28	5392	5016
		6	2.83	452.22	5994	7040
		7	3.25	566.34	6528	9490
		8	3.66	683.03	6996	12351
	8	4	2.60	212.33	3065	3182
		5	3.11	295.88	3571	4831
		6	3.56	379.37	3997	6727
		7	3.99	466.26	4382	9006
		8	4.39	553.13	4725	11652

Table B-7. Properties of Wall Stiffeners With Two Reinforcing Bars in Each Reinforced Cell, 12 in CMU, Type S Mortar.

$b_w=7.5$ in., $d=2.81$ in., $t'=1.00$ in. $n=29000/f'_m$, $F_m=0.33f'_m$ psi, $F_s=24000$ psi Increase M_r by 1/3 for wind or seismic load.					6 in. CMU $f'_m=1000$ psi Type N Mortar	
Stiffener	b in.	bar #	kd in.	I in ⁴	M_r Mas ft.-lb.	M_r Steel ft.-lb.
	36	3	.62	18.16	810	573
		4	.80	29.58	1022	1017
		5	.96	41.39	1196	1544
		6	1.10	53.27	1341	2153
	32	3	.66	17.81	755	570
		4	.84	28.83	949	1011
		5	1.01	40.12	1107	1534
		6	1.16	51.35	1234	2142
	24	3	.74	16.91	633	564
		4	.95	26.92	788	998
		5	1.13	36.90	909	1513
		6	1.29	46.52	999	2115
	16	3	.88	15.52	491	554
		4	1.11	24.05	601	977
		5	1.32	32.13	678	1483
		6	1.49	39.54	736	2071
	8	3	1.15	12.85	310	534
		4	1.42	18.83	368	936
		5	1.63	24.02	408	1408
		6	1.80	28.48	439	1951

Table B-8. Properties of Wall Stiffeners With One Reinforcing Bar in Each Reinforced Cell, 6 in. CMU, Type N Mortar.







$b_w=7.5$ in., $d=3.81$ in., $t'=1.25$ in. $n=29000/f'_m$, $F_m=0.33f'_m$ psi, $F_s=24000$ psi Increase M_T by 1/3 for wind or seismic load.					8 in. CMU $f'_m=1000$ psi Type N Mortar	
Stiffener	b in.	bar #	kd in.	I in ⁴	M_T Mas ft.-lb	M_T Steel ft.-lb.
	48	4	.85	60.64	1990	1411
		5	1.02	86.96	2364	2151
		6	1.18	114.55	2692	3006
		7	1.34	144.64	2997	4040
	40	4	.92	58.82	1784	1402
		5	1.10	83.77	2109	2134
		6	1.27	109.63	2393	2980
		7	1.45	137.47	2642	4009
	32	4	1.01	56.46	1556	1390
		5	1.21	79.67	1831	2112
		6	1.39	103.35	2060	2950
		7	1.58	128.31	2251	3974
	24	4	1.14	53.20	1300	1372
		5	1.36	74.08	1515	2084
		6	1.57	94.80	1681	2914
		7	1.77	116.00	1818	3927
	16	4	1.34	48.22	1000	1346
		5	1.60	65.63	1141	2045
		6	1.83	82.16	1249	2858
		7	2.04	98.39	1337	3842
	8	4	1.74	38.88	622	1294
		5	2.02	50.71	698	1950
		6	2.25	61.26	757	2703
		7	2.45	71.11	806	3607

Table B-9. Properties of Wall Stiffeners With One Reinforcing Bar in Each Reinforced Cell, 8 in CMU, Type N Mortar.

		$b_w=7.5$ in., $d=4.81$ in., $t'=1.375$ in. $n=29000/f'_m$, $F_m=0.33f'_m$ psi, $F_s=24000$ psi Increase M_T by 1/3 for wind or seismic load.				10 in CMU $f'_m=1000$ psi Type N Mortar	
Stiffener	b in.	bar #	kd in.	I in ⁴	M_T Mas ft.-lb.	M_T Steel ft.-lb.	
	48	4	.96	100.13	2885	1795	
		5	1.17	144.74	3442	2741	
		6	1.36	192.12	3938	3835	
		7	1.55	244.43	4391	5165	
	40	4	1.04	97.43	2590	1785	
		5	1.26	139.97	3079	2721	
		6	1.46	184.69	3506	3806	
		7	1.67	233.38	3873	5132	
	32	4	1.15	93.92	2265	1770	
		5	1.39	133.80	2680	2696	
		6	1.61	175.07	3019	3774	
		7	1.84	219.11	3303	5092	
	24	4	1.30	89.03	1899	1750	
		5	1.57	125.29	2221	2664	
		6	1.82	161.82	2469	3733	
		7	2.07	199.74	2675	5036	
	16	4	1.54	81.48	1466	1721	
		5	1.86	112.23	1680	2620	
		6	2.14	141.96	1844	3664	
		7	2.41	171.74	1982	4928	
	8	4	2.02	67.08	923	1657	
		5	2.36	88.85	1046	2501	
		6	2.65	108.81	1142	3468	
		7	2.90	127.92	1223	4630	

Table B-10. Properties of Wall Stiffeners With One Reinforcing Bar in Each Reinforced Cell, 10 in CMU, Type N Mortar.







$b_w=7.5$ in., $d=5.81$ in., $t'=1.5$ in. $n=29000/f'_m$, $F_m=0.33f'_m$ psi, $F_s=24000$ psi Increase M_r by 1/3 for wind or seismic load.					12 in. CMU $f'_m=1000$ psi Type N Mortar	
Stiffener	b in.	bar #	kd in.	I in ⁴	M_r Mas ft.-lb.	M_r Steel ft.-lb.
	48	4	1.07	149.91	3891	2181
		5	1.30	218.01	4659	3334
		6	1.51	291.02	5347	4669
		7	1.73	372.33	5969	6297
	40	4	1.16	146.22	3498	2169
		5	1.41	211.42	4174	3311
		6	1.64	280.66	4764	4638
		7	1.88	356.74	5270	6261
	32	4	1.28	141.39	3065	2153
		5	1.55	202.87	3640	3283
		6	1.81	267.17	4107	4603
		7	2.08	336.48	4500	6217
	24	4	1.45	134.64	2577	2130
		5	1.76	190.98	3022	3249
		6	2.05	248.40	3365	4557
		7	2.35	308.75	3652	6151
	16	4	1.73	124.13	1995	2097
		5	2.09	172.52	2294	3198
		6	2.42	220.02	2525	4476
		7	2.74	268.30	2722	6023
	8	4	2.27	103.80	1269	2024
		5	2.67	139.13	1446	3058
		6	3.01	172.19	1588	4243
		7	3.32	204.46	1710	5666

Table B-11. Properties of Wall Stiffeners With One Reinforcing Bar in Each Reinforced Cell, 12 in CMU, Type N Mortar.







$b_w=7.5$ in., $d=5.31$ in., $t'=1.25$ in. $n=29000/f'_m$, $F_m=0.33f'_m$ psi, $F_s=24000$ psi Increase M_r by 1/3 for wind or seismic load.					8 in. CMU $f'_m=1000$ psi Type N Mortar	
Stiffener	b in.	bar #	kd in.	I in. ⁴	M_r Mas ft.-lb.	M_r Steel ft.-lb.
	48	3	.78	73.05	2614	1111
		4	1.02	123.72	3375	1988
		5	1.24	179.42	4034	3037
		6	1.44	238.79	4591	4260
		7	1.67	304.06	5059	5760
	40	3	.84	71.64	2358	1106
		4	1.10	120.55	3032	1977
		5	1.34	173.76	3606	3017
		6	1.57	229.73	4061	4238
		7	1.82	290.31	4439	5731
	32	3	.93	69.78	2075	1100
		4	1.22	116.39	2655	1962
		5	1.48	166.35	3121	2996
		6	1.74	217.86	3476	4210
		7	2.01	272.52	3771	5691
	24	3	1.06	67.15	1755	1090
		4	1.38	110.59	2223	1942
		5	1.69	155.95	2568	2969
		6	1.98	201.45	2831	4168
		7	2.26	248.54	3050	5626
	16	3	1.27	62.99	1378	1075
		4	1.65	101.47	1704	1914
		5	2.00	139.97	1940	2920
		6	2.32	177.20	2123	4086
		7	2.62	214.54	2277	5495
	8	3	1.70	54.66	893	1044
		4	2.15	84.30	1088	1841
		5	2.52	112.31	1237	2779
		6	2.84	138.26	1354	3855
		7	3.12	163.35	1454	5147

Table B-12. Properties of Wall Stiffeners With Two Reinforcing Bars in Each Reinforced Cell, 8 in CMU, Type N Mortar.

$b_w=7.5$ in., $d=7.06$ in., $t'=1.375$ in $n=29000/f'_m$, $F_m=0.33f'_m$ psi, $F_g=24000$ psi Increase M_r by 1/3 for wind or seismic load.					10 in. CMU $f'_m=1000$ psi Type N Mortar	
Stiffener	b in.	bar #	kd in.	I in ⁴	M_r Mas ft.-lb.	M_r Steel ft.-lb.
	48	4	1.19	226.81	5290	2665
		5	1.45	331.71	6349	4079
		6	1.71	444.72	7205	5737
		7	2.00	570.21	7922	7771
		8	2.29	703.07	8514	10173
	40	4	1.29	221.72	4763	2652
		5	1.58	322.47	5668	4059
		6	1.87	429.58	6368	5712
		7	2.19	546.85	6952	7736
		8	2.50	669.29	7435	10123
	32	4	1.43	215.03	4179	2634
		5	1.76	310.22	4901	4035
		6	2.09	409.58	5452	5680
		7	2.43	516.47	5914	7686
		8	2.76	626.17	6298	10047
	24	4	1.63	205.57	3495	2613
		5	2.02	292.82	4036	4003
		6	2.38	381.74	4453	5627
		7	2.75	475.30	4806	7601
		8	3.10	569.36	5103	9914
	16	4	1.97	190.45	2686	2580
		5	2.41	265.90	3068	3941
		6	2.81	340.44	3370	5519
		7	3.19	416.79	3631	7425
		8	3.55	491.71	3853	9648
	8	4	2.57	161.91	1751	2486
		5	3.04	219.43	2008	3761
		6	3.44	274.30	2216	5223
		7	3.81	328.86	2398	6977
		8	4.14	381.04	2554	9014

Table B-13. Properties of Wall Stiffeners With Two Reinforcing Bars in Each Reinforced Cell, 10 in CMU, Type N Mortar.







$b_w=7.5$ in., $d=8.81$ in., $t'=1.5$ in. $n=29000/f'_m$, $F_m=0.33f'_m$ psi, $F_g=24000$ psi Increase M_r by 1/3 for wind or seismic load.					12 in. CMU $f'_m=1000$ psi Type N Mortar	
Stiffener	b in.	bar #	kd in.	I in ⁴	M_r Mas ft.-lb.	M_r Steel ft.-lb.
	48	4	1.34	362.14	7489	3345
		5	1.64	532.70	9002	5127
		6	1.95	717.89	10204	7222
		7	2.29	925.17	11211	9790
		8	2.64	1146.55	12046	12824
	40	4	1.46	354.83	6751	3329
		5	1.80	519.24	8033	5105
		6	2.14	695.51	9018	7194
		7	2.51	890.29	9844	9749
	32	4	1.62	345.17	5926	3310
		5	2.00	501.23	6945	5080
		6	2.39	665.78	7727	7156
		7	2.80	844.70	8386	9690
	24	4	1.86	331.38	4957	3287
		5	2.31	475.52	5727	5042
		6	2.74	624.22	6326	7093
		7	3.18	782.71	6840	9585
	16	4	2.25	309.15	3820	3249
		5	2.76	435.52	4376	4968
		6	3.24	562.35	4822	6962
		7	3.70	694.33	5214	9370
	8	4	2.94	267.12	2524	3138
		5	3.49	366.48	2915	4753
		6	3.98	463.25	3237	6608
		7	4.43	561.45	3523	8835
		8	4.84	657.22	3771	11419

Table B-14. Properties of Wall Stiffeners With Two Reinforcing Bars in Each Reinforced Cell, 12 in CMU, Type N Mortar.

Table B-15. Reinforcement spacing in inches for 6 inch CMU wall with one reinforcing bar in each reinforced cell.

Wall Ht. Ft.	Bar #	Wind Load, psf								
		5	10	15	20	25	30	35	40	
18	6	88	48	32	8		6 in. CMU P=0 lb./ft. e=0 Type S Mortar			
	5	80	40	16	8					
	4	64	32	8						
	3	32	16	8						
17	6	96	56	40	16	8				
	5	96	48	32	16	8				
	4	72	40	24	8					
	3	40	16	8						
16	6	96	64	48	32	16	8			
	5	96	56	40	24	8				
	4	88	40	24	16	8				
	3	48	24	16	8					
15	6	96	80	48	40	24	16	8		
	5	96	72	48	32	16	8			
	4	96	48	32	24	8	8			
	3	56	24	16	8	8				
14	6	96	88	64	48	32	24	16	8	
	5	96	80	56	40	32	16	8		
	4	96	56	40	24	16	8	8		
	3	64	32	16	16	8				
13	6	96	96	72	56	40	32	24	16	
	5	96	96	64	48	40	24	16	8	
	4	96	72	48	32	24	16	8	8	
	3	80	40	24	16	8	8			
12	6	96	96	88	64	56	40	40	32	
	5	96	96	80	56	48	40	32	24	
	4	96	88	56	40	32	24	16	8	
	3	96	48	32	24	16	16	8	8	
11	6	96	96	96	80	64	56	48	40	
	5	96	96	96	72	56	48	40	32	
	4	96	96	64	48	40	32	24	24	
	3	96	56	32	24	16	16	16	8	
10	6	96	96	96	96	80	64	56	48	
	5	96	96	96	88	72	56	48	40	
	4	96	96	80	64	48	40	32	24	
	3	96	72	48	32	24	16	16	16	

Table B-16. Reinforcement spacing in inches for 6 inch CMU wall with one reinforcing bar in each reinforced cell.

Wall Ht. Ft.	Bar #	Wind Load, psf								
		5	10	15	20	25	30	35	40	
18	6	72	40	16	8		6 in. CMU P=500 lb./ft. e=0 Type S Mortar			
	5	64	32	8						
	4	48	24	8						
	3	24	16							
17	6	88	48	32	8	8				
	5	80	40	24	8					
	4	64	32	16	8					
	3	32	16	8						
16	6	96	56	40	24	8	8			
	5	88	48	32	16	8				
	4	80	40	24	8					
	3	40	16	8	8					

TM 5-809-3/NAVFAC DM-2.9/AFM 88-3, Chap. 3

Table B-16. Reinforcement spacing in inches for 6 inch CMU wall with one reinforcing bar in each reinforced cell—Continued.

Wall Ht. Ft.	Bar #	Wind Load, psf							
		5	10	15	20	25	30	35	40
15	6	96	64	48	32	16	8	8	
	5	96	56	40	24	16	8		
	4	88	48	32	16	8			
	3	48	24	16	8				
14	6	96	80	56	40	32	16	8	8
	5	96	72	48	32	24	8	8	
	4	96	56	32	24	16	8		
	3	64	32	16	8	8			
13	6	96	88	64	48	40	32	16	8
	5	96	80	56	40	32	24	16	8
	4	96	64	40	32	24	16	8	
	3	72	32	24	16	8	8		
12	6	96	96	80	64	48	40	32	24
	5	96	96	72	56	40	32	24	16
	4	96	80	48	40	32	24	16	8
	3	88	40	24	16	16	8	8	8
11	6	96	96	96	72	56	48	40	32
	5	96	96	88	64	56	40	40	32
	4	96	96	64	48	40	32	24	16
	3	96	48	32	24	16	16	8	8
10	6	96	96	96	96	72	64	48	48
	5	96	96	96	80	64	56	48	40
	4	96	96	80	56	48	40	32	24
	3	96	64	40	32	24	16	16	16

Table B-17. Reinforcement spacing in inches for 6 inch CMU wall with one reinforcing bar in each reinforced cell.

Wall Ht. Ft.	Bar #	Wind Load, psf							
		5	10	15	20	25	30	35	40
18	6	56	32	8	8				
	5	56	24	8					
	4	40	16	8					
	3	24	8						
17	6	72	40	24	8				
	5	64	40	16	8				
	4	56	24	8					
	3	32	16	8					
16	6	88	48	32	16	8			
	5	72	48	32	16	8			
	4	64	32	16	8				
	3	32	16	8					
15	6	96	56	40	32	16	8		
	5	88	48	40	24	8	8		
	4	72	40	24	16	8			
	3	40	24	16	8				
14	6	96	64	48	40	24	16	8	
	5	96	56	40	32	16	8	8	
	4	80	48	32	24	8	8		
	3	48	24	16	8	8			
13	6	96	80	56	40	32	24	16	8
	5	96	72	48	40	32	16	8	8
	4	88	56	40	24	16	8	8	
	3	56	32	16	16	8	8		

Table B-17. Reinforcement spacing in inches for 6 inch CMU wall with one reinforcing bar in each reinforced cell—Continued.

Wall Ht. Ft.	Bar #	Wind Load, psf							
		5	10	15	20	25	30	35	40
12	6	96	96	72	56	48	40	32	24
	5	96	88	64	48	40	32	24	16
	4	96	64	48	32	24	24	16	8
	3	56	32	24	16	16	8	8	
11	6	96	96	88	64	56	48	40	32
	5	96	96	72	56	48	40	32	24
	4	96	72	56	40	32	24	24	16
	3	64	40	24	24	16	16	8	8
10	6	96	96	96	80	64	56	48	40
	5	96	96	88	72	56	48	40	32
	4	96	88	64	48	40	32	24	24
	3	72	48	32	24	24	16	16	8

Table B-18. Reinforcement spacing in inches for 6 inch CMU wall with one reinforcing bar in each reinforced cell.

Wall Ht. Ft.	Bar #	Wind Load, psf							
		5	10	15	20	25	30	35	40
18	6	56	32	8	8				
	5	48	24	8					
	4	40	16	8					
	3	24	8						
17	6	64	40	24	8				
	5	64	32	16	8				
	4	48	24	8					
	3	24	16	8					
16	6	80	48	32	16	8			
	5	72	40	24	8	8			
	4	56	32	16	8				
	3	32	16	8					
15	6	88	56	40	24	16	8		
	5	80	48	32	16	8	8		
	4	64	40	24	8	8			
	3	32	16	8	8				
14	6	96	64	48	32	24	16	8	
	5	88	56	40	32	16	8	8	
	4	72	40	32	16	8	8		
	3	40	24	16	8	8			
13	6	96	72	56	40	32	24	16	8
	5	96	64	48	40	24	16	8	8
	4	80	48	32	24	16	8	8	
	3	48	24	16	16	8			
12	6	96	96	64	56	40	32	32	16
	5	96	80	56	48	40	32	16	16
	4	88	56	40	32	24	16	8	8
	3	48	32	24	16	16	8	8	
11	6	96	96	80	64	48	40	40	32
	5	96	96	72	56	48	40	32	24
	4	96	64	48	40	32	24	24	16
	3	48	32	24	16	16	16	8	8
10	6	96	96	96	72	64	48	48	40
	5	96	96	80	64	56	48	40	32
	4	96	72	56	48	40	32	24	24
	3	48	40	32	24	16	16	16	8

TM 5-809-3/NAVFAC DM-2.9/AFM 88-3, Chap. 3

Table B-19. Reinforcement spacing in inches for 6 inch CMU wall with one reinforcing bar in each reinforced cell.

Wall Ht. Ft.	Bar #	Wind Load, psf									
		5	10	15	20	25	30	35	40		
18	6	56	24	8	6 in. CMU P=1000 lb./ft. e=0 Type S Mortar						
	5	48	24	8							
	4	40	16	8							
	3	24	8								
17	6	72	40	16	8	6 in. CMU P=1000 lb./ft. e=0 Type S Mortar					
	5	72	32	16	8						
	4	56	24	8							
	3	32	16	8							
16	6	88	48	32	16	8	6 in. CMU P=1000 lb./ft. e=0 Type S Mortar				
	5	80	40	24	8	8					
	4	64	32	16	8						
	3	40	16	8							
15	6	96	56	40	24	16	8	6 in. CMU P=1000 lb./ft. e=0 Type S Mortar			
	5	96	48	32	16	8	8				
	4	80	40	24	8	8					
	3	48	24	16	8						
14	6	96	64	48	32	24	16	8	6 in. CMU P=1000 lb./ft. e=0 Type S Mortar		
	5	96	64	40	32	16	8	8			
	4	96	48	32	16	8	8				
	3	56	24	16	8	8					
13	6	96	80	56	40	32	24	16	8	6 in. CMU P=1000 lb./ft. e=0 Type S Mortar	
	5	96	72	48	40	24	16	8	8		
	4	96	56	40	24	16	8	8			
	3	64	32	24	16	8	8				
12	6	96	96	80	56	48	40	32	24	6 in. CMU P=1000 lb./ft. e=0 Type S Mortar	
	5	96	96	72	48	40	32	24	16		
	4	96	72	48	32	24	24	16	8		
	3	80	40	24	16	16	8	8			
11	6	96	96	96	72	56	48	40	32	6 in. CMU P=1000 lb./ft. e=0 Type S Mortar	
	5	96	96	80	64	48	40	32	24		
	4	96	88	56	40	32	24	24	16		
	3	96	48	32	24	16	16	8	8		
10	6	96	96	96	88	72	56	48	40	6 in. CMU P=1000 lb./ft. e=0 Type S Mortar	
	5	96	96	96	72	64	48	40	40		
	4	96	96	72	56	40	32	32	24		
	3	96	56	40	32	24	16	16	16		

Table B-20. Reinforcement spacing in inches for 6 inch CMU wall with one reinforcing bar in each reinforced cell.

Wall Ht. Ft.	Bar #	Wind Load, psf								
		5	10	15	20	25	30	35	40	
18	6	40	16	8	6 in. CMU P=1000 lb./ft. e=t/3 Type S Mortar					
	5	40	16	8						
	4	24	8							
	3	16	8							
17	6	56	32	16	8	6 in. CMU P=1000 lb./ft. e=t/3 Type S Mortar				
	5	48	24	8						
	4	40	16	8						
	3	24	8							
16	6	64	40	24	8	8	6 in. CMU P=1000 lb./ft. e=t/3 Type S Mortar			
	5	56	32	16	8					
	4	48	24	8	8					
	3	24	16	8						

Table B-20. Reinforcement spacing in inches for 6 inch CMU wall with one reinforcing bar in each reinforced cell—Continued.

Wall Ht. Ft.	Bar #	Wind Load, psf							
		5	10	15	20	25	30	35	40
15	6	72	48	32	16	8	8		
	5	64	40	24	16	8			
	4	56	32	16	8				
	3	32	16	8					
14	6	80	56	40	32	16	8	8	
	5	72	48	32	24	8	8		
	4	56	40	24	16	8			
	3	32	16	16	8				
13	6	88	64	48	40	24	16	8	8
	5	80	56	40	32	16	8	8	
	4	64	40	32	24	8	8		
	3	32	24	16	8	8			
12	6	96	80	56	48	40	32	24	16
	5	88	72	48	40	32	24	16	8
	4	64	48	40	32	24	16	8	8
	3	32	24	16	16	8	8		
11	6	96	88	72	56	48	40	32	24
	5	88	80	64	48	40	32	24	16
	4	64	56	40	32	24	24	16	8
	3	32	32	24	16	16	8	8	8
10	6	96	96	80	64	56	48	40	32
	5	88	88	72	56	48	40	32	32
	4	64	64	48	40	32	24	24	16
	3	32	32	24	24	16	16	8	8

Table B-21. Reinforcement spacing in inches for 6 inch CMU wall with one reinforcing bar in each reinforced cell.

Wall Ht. Ft.	Bar #	Wind Load, psf							
		5	10	15	20	25	30	35	40
18	6	40	16	8					
	5	32	8						
	4	24	8						
	3	16	8						
17	6	48	24	8	8				
	5	40	16	8					
	4	32	16	8					
	3	16	8						
16	6	56	32	16	8				
	5	48	32	16	8				
	4	40	24	8					
	3	16	8	8					
15	6	64	40	32	16	8			
	5	56	40	24	8	8			
	4	40	24	16	8				
	3	24	16	8					
14	6	64	48	40	24	16	8		
	5	56	40	32	16	8	8		
	4	40	32	24	8	8			
	3	24	16	8	8				
13	6	64	56	40	32	24	16	8	8
	5	56	48	40	24	16	8	8	
	4	40	40	24	16	8	8		
	3	24	16	16	8	8			

TM 5-809-3/NAVFAC DM-2.9/AFM 88-3, Chap. 3

Table B-21. Reinforcement spacing in inches for 6 inch CMU wall with one reinforcing bar in each reinforced cell—Continued.

Wall Ht. Ft.	Bar #	Wind Load, psf							
		5	10	15	20	25	30	35	40
12	6	64	64	56	40	32	24	16	8
	5	56	56	48	40	32	16	16	8
	4	40	40	32	24	16	8	8	8
	3	24	24	16	16	8	8		
11	6	64	64	56	48	40	32	32	24
	5	56	56	56	40	40	32	24	16
	4	40	40	40	32	24	16	16	8
	3	24	24	16	16	16	8	8	
10	6	64	64	64	56	48	40	40	32
	5	56	56	56	48	40	40	32	24
	4	40	40	40	32	32	24	24	16
	3	24	24	24	16	16	16	8	8

Table B-22. Reinforcement spacing in inches for 6 inch CMU wall with one reinforcing bar in each reinforced cell.

Wall Ht. Ft.	Bar #	Wind Load, psf							
		5	10	15	20	25	30	35	40
18	6	32	16	8					
	5	32	16	8					
	4	24	8						
	3	16	8						
17	6	64	32	16	8				
	5	56	32	8					
	4	40	24	8					
	3	24	8						
16	6	80	40	24	8	8			
	5	72	40	16	8				
	4	56	32	8	8				
	3	32	16	8					
15	6	88	48	32	16	8	8		
	5	88	48	32	16	8			
	4	72	40	24	8	8			
	3	40	16	8	8				
14	6	96	64	40	32	16	8	8	
	5	96	56	40	24	16	8		
	4	88	48	32	16	8			
	3	48	24	16	8				
13	6	96	72	48	40	32	16	8	8
	5	96	64	48	32	24	16	8	8
	4	96	56	32	24	16	8	8	
	3	56	32	16	16	8			
12	6	96	96	72	56	40	32	24	16
	5	96	96	64	48	40	32	16	8
	4	96	64	48	32	24	16	8	8
	3	72	40	24	16	16	8	8	
11	6	96	96	88	64	48	40	40	32
	5	96	96	80	56	48	40	32	24
	4	96	80	56	40	32	24	24	16
	3	88	48	32	24	16	16	8	8
10	6	96	96	96	80	64	56	48	40
	5	96	96	96	72	56	48	40	32
	4	96	96	64	48	40	32	24	24
	3	96	56	40	24	24	16	16	8

Table B-23. Reinforcement spacing in inches for 6 inch CMU wall with one reinforcing bar in each reinforced cell—Continued.

Wall Ht. Ft.	Bar #	Wind Load, psf							
		5	10	15	20	25	30	35	40
18	6	24	8						
	5	24	8						
	4	16	8						
	3	8							
17	6	40	16	8					
	5	40	16	8					
	4	24	8						
	3	16	8						
16	6	48	32	16	8				
	5	40	24	8	8				
	4	32	16	8					
	3	16	8						
15	6	56	40	24	8	8			
	5	48	32	16	8				
	4	32	24	8	8				
	3	16	16	8					
14	6	56	40	32	16	8	8		
	5	48	40	24	16	8			
	4	32	32	16	8	8			
	3	16	16	8					
13	6	56	48	40	32	16	8	8	
	5	48	48	32	24	8	8		
	4	40	32	24	16	8	8		
	3	16	16	16	8				
12	6	56	56	48	40	32	24	16	8
	5	56	56	40	32	24	16	8	8
	4	40	40	32	24	16	8	8	
	3	16	16	16	8	8	8		
11	6	64	64	56	48	40	32	24	16
	5	56	56	48	40	32	24	16	16
	4	40	40	32	24	24	16	8	8
	3	24	24	16	16	8	8	8	
10	6	64	64	64	56	48	40	32	32
	5	56	56	56	48	40	32	32	24
	4	40	40	40	32	24	24	16	16
	3	24	24	24	16	16	8	8	8

Table B-24. Reinforcement spacing in inches for 6 inch CMU wall with one reinforcing bar in each reinforced cell.

Wall Ht. Ft.	Bar #	Wind Load, psf							
		5	10	15	20	25	30	35	40
18	6	16	8						
	5	8	8						
	4	8							
	3	8							
17	6	24	16	8					
	5	16	8						
	4	16	8						
	3	8							
16	6	32	24	8	8				
	5	24	16	8					
	4	16	8	8					
	3	8	8						

TM 5-809-3/NAVFAC DM-2.9/AFM 88-3, Chap. 3

Table B-24. Reinforcement spacing in inches for 6 inch CMU wall with one reinforcing bar in each reinforced cell—Continued.

Wall Ht. Ft.	Bar #	Wind Load, psf							
		5	10	15	20	25	30	35	40
15	6	32	32	16	8	8			
	5	32	24	8	8				
	4	24	16	8					
	3	8	8						
14	6	40	40	24	16	8			
	5	32	32	16	8	8			
	4	24	24	8	8				
	3	8	8	8					
13	6	40	40	32	24	16	8	8	
	5	32	32	24	16	8	8		
	4	24	24	16	8	8			
	3	8	8	8	8				
12	6	40	40	40	32	24	16	8	8
	5	32	32	32	24	16	8	8	8
	4	24	24	24	16	8	8	8	
	3	16	16	16	8	8			
11	6	40	40	40	40	32	24	16	16
	5	32	32	32	32	24	16	16	8
	4	24	24	24	24	16	8	8	8
	3	16	16	16	8	8	8		
10	6	40	40	40	40	40	32	32	24
	5	32	32	32	32	32	24	24	16
	4	24	24	24	24	24	16	16	8
	3	16	16	16	16	8	8	8	8

Table B-25. Reinforcement spacing in inches for 8 inch CMU wall with one reinforcing bar in each reinforced cell.

Wall Ht. Ft.	Bar #	Wind Load, psf								
		5	10	15	20	25	30	35	40	
23	7	96	64	40	16	8	8 in. CMU P=0 lb./ft. e=0 Type S Mortar			
	6	96	56	32	8	8				
	5	88	40	24	8					
	4	56	24	16						
21	7	96	88	56	40	16				
	6	96	72	48	24	16				
	5	96	56	32	16	8				
	4	72	32	16	8	8				
19	7	96	96	72	56	40	24	8	8	
	6	96	88	64	48	32	16	8		
	5	96	64	40	32	16	8	8		
	4	88	40	24	16	8	8			
18	7	96	96	80	64	48	32	16	8	
	6	96	96	72	48	40	24	16	8	
	5	96	72	48	32	24	16	8	8	
	4	96	48	32	24	16	8	8		
17	7	96	96	96	72	56	48	32	16	
	6	96	96	80	56	48	32	24	16	
	5	96	88	56	40	32	24	16	8	
	4	96	56	32	24	16	16	8	8	
16	7	96	96	96	80	64	56	48	32	
	6	96	96	96	72	56	48	32	24	
	5	96	96	64	48	40	32	24	16	
	4	96	64	40	32	24	16	16	8	

Table B-25. Reinforcement spacing in inches for 8 inch CMU wall with one reinforcing bar in each reinforced cell—Continued.

Wall Ht. Ft.	Bar #	Wind Load, psf							
		5	10	15	20	25	30	35	40
15	7	96	96	96	96	72	64	56	48
	6	96	96	96	80	64	48	40	32
	5	96	96	72	56	40	32	32	24
	4	96	72	48	32	24	24	16	16
14	7	96	96	96	96	88	72	64	56
	6	96	96	96	88	72	56	48	48
	5	96	96	88	64	48	40	32	32
	4	96	88	56	40	32	24	24	16
13	7	96	96	96	96	96	80	72	64
	6	96	96	96	96	88	72	56	48
	5	96	96	96	72	56	48	40	32
	4	96	96	64	48	40	32	24	24
12	7	96	96	96	96	96	88	72	64
	6	96	96	96	96	96	80	72	64
	5	96	96	96	88	72	56	48	40
	4	96	96	80	56	48	40	32	24
11	7	96	96	96	96	96	96	80	72
	6	96	96	96	96	96	96	80	72
	5	96	96	96	96	88	72	64	56
	4	96	96	96	72	56	48	40	32

Table B-26. Reinforcement spacing in inches for 8 inch CMU wall with one reinforcing bar in each reinforced cell.

Wall Ht. Ft.	Bar #	Wind Load, psf							
		5	10	15	20	25	30	35	40
23	7	96	56	32	8	8	8 in. CMU P=500 lb./ft. e=0 Type S Mortar		
	6	96	48	24	8				
	5	72	32	16	8				
	4	48	24	8					
21	7	96	72	48	32	16			
	6	96	64	40	24	8			
	5	96	48	32	16	8			
	4	64	32	16	8				
19	7	96	96	64	48	32	16	8	8
	6	96	80	56	40	24	8	8	
	5	96	64	40	24	16	8		
	4	80	40	24	16	8	8		
18	7	96	96	72	56	48	24	16	8
	6	96	96	64	48	32	16	8	8
	5	96	72	48	32	24	16	8	
	4	96	48	32	16	16	8		
17	7	96	96	88	64	48	40	24	16
	6	96	96	72	56	40	32	16	8
	5	96	80	56	40	32	16	8	8
	4	96	56	32	24	16	8	8	
16	7	96	96	96	80	64	48	40	24
	6	96	96	88	64	48	40	32	16
	5	96	96	64	48	32	32	24	16
	4	96	64	40	32	24	16	16	8
15	7	96	96	96	88	72	56	48	40
	6	96	96	96	72	56	48	40	32
	5	96	96	72	56	40	32	32	24
	4	96	72	48	32	24	24	16	16

TM 5-809-3/NAVFAC DM-2.9/AFM 88-3, Chap. 3

Table B-26. Reinforcement spacing in inches for 8 inch CMU wall with one reinforcing bar in each reinforced cell—Continued.

Wall Ht. Ft.	Bar #	Wind Load, psf							
		5	10	15	20	25	30	35	40
14	7	96	96	96	96	80	72	56	48
	6	96	96	96	88	72	56	48	40
	5	96	96	80	64	48	40	32	32
	4	96	80	56	40	32	24	24	16
13	7	96	96	96	96	96	80	72	56
	6	96	96	96	96	80	64	56	48
	5	96	96	96	72	56	48	40	32
	4	96	96	64	48	40	32	24	24
12	7	96	96	96	96	96	88	72	64
	6	96	96	96	96	96	80	64	56
	5	96	96	96	88	64	56	48	40
	4	96	96	72	56	40	32	32	24
11	7	96	96	96	96	96	96	80	72
	6	96	96	96	96	96	96	80	72
	5	96	96	96	96	80	64	56	48
	4	96	96	88	64	56	40	40	32

Table B-27. Reinforcement spacing in inches for 8 inch CMU wall with one reinforcing bar in each reinforced cell.

Wall Ht. Ft.	Bar #	Wind Load, psf							
		5	10	15	20	25	30	35	40
23	7	96	56	24	8				
	6	80	48	16	8				
	5	64	32	16	8				
	4	40	16	8					
21	7	96	64	48	24	8			
	6	96	56	40	16	8			
	5	80	40	24	8	8			
	4	56	24	16	8				
19	7	96	88	64	48	24	16	8	
	6	96	72	48	40	16	8	8	
	5	96	56	40	24	16	8		
	4	64	32	24	16	8			
18	7	96	96	64	56	40	24	16	8
	6	96	80	56	40	32	16	8	8
	5	96	64	40	32	16	8	8	
	4	72	40	24	16	8	8		
17	7	96	96	80	56	48	32	24	16
	6	96	96	64	48	40	24	16	8
	5	96	72	48	32	24	16	8	8
	4	80	48	32	24	16	8	8	
16	7	96	96	96	72	56	48	40	24
	6	96	96	80	56	48	40	24	16
	5	96	80	56	40	32	24	16	8
	4	88	48	32	24	24	16	8	8
15	7	96	96	96	80	64	56	48	40
	6	96	96	88	72	56	48	40	24
	5	96	88	64	48	40	32	24	16
	4	96	56	40	32	24	16	16	8
14	7	96	96	96	96	80	64	56	48
	6	96	96	96	80	64	56	48	40
	5	96	96	72	56	48	40	32	24
	4	96	64	48	32	24	24	16	16

Table B-27. Reinforcement spacing in inches for 8 inch CMU wall with one reinforcing bar in each reinforced cell—Continued.

Wall Ht. Ft.	Bar #	Wind Load, psf							
		5	10	15	20	25	30	35	40
13	7	96	96	96	96	88	72	64	56
	6	96	96	96	88	72	64	56	48
	5	96	96	80	64	48	40	40	32
	4	96	72	56	40	32	24	24	16
12	7	96	96	96	96	96	88	72	64
	6	96	96	96	96	88	72	64	56
	5	96	96	96	72	64	48	40	40
	4	96	88	64	48	40	32	24	24
11	7	96	96	96	96	96	96	80	72
	6	96	96	96	96	96	88	72	64
	5	96	96	96	88	72	64	48	48
	4	96	96	72	56	48	40	32	32

Table B-28. Reinforcement spacing in inches for 8 inch CMU wall with one reinforcing bar in each reinforced cell.

Wall Ht. Ft.	Bar #	Wind Load, psf							
		5	10	15	20	25	30	35	40
23	7	88	48	24	8				
	6	80	40	16	8				
	5	56	32	8	8				
	4	40	16	8					
21	7	96	64	48	24	8			
	6	96	56	40	16	8			
	5	72	40	24	8	8			
	4	48	24	16	8				
19	7	96	80	56	48	24	16	8	
	6	96	72	48	32	16	8	8	
	5	96	56	32	24	8	8		
	4	64	32	24	16	8			
18	7	96	88	64	48	40	24	8	8
	6	96	80	56	40	24	16	8	8
	5	96	56	40	32	16	8	8	
	4	64	40	24	16	8	8		
17	7	96	96	72	56	48	32	16	8
	6	96	88	64	48	40	24	16	8
	5	96	64	48	32	24	16	8	8
	4	72	40	32	24	16	8	8	
16	7	96	96	88	72	56	48	32	24
	6	96	96	72	56	48	40	24	16
	5	96	72	56	40	32	24	16	8
	4	80	48	32	24	16	16	8	8
15	7	96	96	96	80	64	56	48	32
	6	96	96	88	64	56	48	40	24
	5	96	80	56	48	40	32	24	16
	4	88	56	40	32	24	16	16	8
14	7	96	96	96	88	72	64	56	48
	6	96	96	96	72	64	48	48	40
	5	96	96	64	56	40	32	32	24
	4	96	56	40	32	24	24	16	16
13	7	96	96	96	96	88	72	64	56
	6	96	96	96	88	72	56	48	48
	5	96	96	80	56	48	40	32	32
	4	96	64	48	40	32	24	24	16

TM 5-809-3/NAVFAC DM-2.9/AFM 88-3, Chap. 3

Table B-28. Reinforcement spacing in inches for 8 inch CMU wall with one reinforcing bar in each reinforced cell—Continued.

Wall Ht. Ft.	Bar #	Wind Load, psf							
		5	10	15	20	25	30	35	40
12	7	96	96	96	96	96	80	72	64
	6	96	96	96	96	80	72	56	56
	5	96	96	88	72	56	48	40	40
	4	96	72	56	48	32	32	24	24
11	7	96	96	96	96	96	88	80	64
	6	96	96	96	96	96	80	72	64
	5	96	96	96	80	64	56	48	40
	4	96	88	64	48	40	32	32	24

Table B-29. Reinforcement spacing in inches for 8 inch CMU wall with one reinforcing bar in each reinforced cell.

Wall Ht. Ft.	Bar #	Wind Load, psf							
		5	10	15	20	25	30	35	40
23	7	96	48	16	8		8 in. CMU P=1000 lb./ft. e=0 Type S Mortar		
	6	88	40	16	8				
	5	64	32	8					
	4	40	16	8					
21	7	96	64	48	24	8			
	6	96	56	32	16	8			
	5	88	40	24	8	8			
	4	56	24	16	8				
19	7	96	88	56	48	24	16	8	
	6	96	72	48	32	16	8	8	
	5	96	56	40	24	16	8		
	4	72	40	24	16	8			
18	7	96	96	64	48	40	24	8	8
	6	96	88	56	40	24	16	8	8
	5	96	64	40	32	16	8	8	
	4	88	40	24	16	8	8		
17	7	96	96	80	56	48	32	16	8
	6	96	96	64	48	40	24	16	8
	5	96	72	48	32	24	16	8	8
	4	96	48	32	24	16	8	8	
16	7	96	96	96	72	56	48	40	24
	6	96	96	80	64	48	40	24	16
	5	96	88	56	40	32	24	16	8
	4	96	56	40	24	24	16	8	8
15	7	96	96	96	88	64	56	48	40
	6	96	96	96	72	56	48	40	24
	5	96	96	64	48	40	32	24	16
	4	96	64	40	32	24	16	16	8
14	7	96	96	96	96	80	64	56	48
	6	96	96	96	80	64	56	48	40
	5	96	96	80	56	48	40	32	24
	4	96	80	48	40	32	24	16	16
13	7	96	96	96	96	96	80	64	56
	6	96	96	96	96	80	64	56	48
	5	96	96	96	72	56	48	40	32
	4	96	88	56	48	32	24	24	16
12	7	96	96	96	96	96	88	72	64
	6	96	96	96	96	88	80	64	56
	5	96	96	96	80	64	56	48	40
	4	96	96	72	56	40	32	32	24

Table B-29. Reinforcement spacing in inches for 8 inch CMU wall with one reinforcing bar in each reinforced cell—Continued.

Wall Ht. Ft.	Bar #	Wind Load, psf							
		5	10	15	20	25	30	35	40
11	7	96	96	96	96	96	96	80	72
	6	96	96	96	96	96	88	80	64
	5	96	96	96	96	80	64	56	48
	4	96	96	88	64	48	40	32	32

Table B-30. Reinforcement spacing in inches for 8 inch CMU wall with one reinforcing bar in each reinforced cell.

Wall Ht. Ft.	Bar #	Wind Load, psf							
		5	10	15	20	25	30	35	40
23	7	72	40	16	8	8 in. CMU P=1000 lb./ft. e=t/3 Type S Mortar	8	8	8
	6	64	32	8	8				
	5	48	24	8	8				
	4	32	16	8	8				
21	7	88	56	32	16	8	8	8	8
	6	80	48	24	8	8			
	5	64	40	16	8	8			
	4	40	24	8	8	8			
19	7	96	72	48	32	16	8	8	8
	6	96	64	40	24	16	8	8	
	5	80	48	32	16	8	8	8	
	4	48	32	16	8	8	8	8	
18	7	96	80	56	48	24	16	8	8
	6	96	64	48	32	16	8	8	8
	5	88	56	32	24	16	8	8	8
	4	56	32	24	16	8	8	8	8
17	7	96	88	64	48	40	24	16	8
	6	96	72	56	40	32	16	8	8
	5	96	56	40	32	16	8	8	8
	4	64	40	24	16	16	8	8	8
16	7	96	96	80	64	48	40	24	16
	6	96	96	64	56	40	32	24	16
	5	96	64	48	40	32	24	16	8
	4	64	40	32	24	16	16	8	8
15	7	96	96	88	72	56	48	40	32
	6	96	96	72	56	48	40	32	24
	5	96	72	56	40	32	24	24	16
	4	64	48	32	24	24	16	16	8
14	7	96	96	96	80	64	56	48	40
	6	96	96	88	64	56	48	40	32
	5	96	80	56	48	40	32	24	24
	4	64	48	40	32	24	16	16	16
13	7	96	96	96	96	80	64	56	48
	6	96	96	96	80	64	56	48	40
	5	96	88	64	56	48	40	32	32
	4	64	56	40	32	24	24	16	16
12	7	96	96	96	96	88	72	64	56
	6	96	96	96	88	72	64	56	48
	5	96	96	80	64	48	48	40	32
	4	64	64	48	40	32	24	24	24
11	7	96	96	96	96	96	88	72	64
	6	96	96	96	96	88	72	64	56
	5	96	96	88	72	56	48	48	40
	4	64	64	56	48	40	32	24	24

TM 5-809-3/NAVFAC DM-2.9/AFM 88-3, Chap. 3

Table B-31. Reinforcement spacing in inches for 8 inch CMU wall with one reinforcing bar in each reinforced cell.

Wall Ht. Ft.	Bar #	Wind Load, psf							
		5	10	15	20	25	30	35	40
23	7	64	32	8	8				
	6	56	24	8					
	5	40	16	8					
	4	24	16						
21	7	80	56	32	16	8			
	6	72	48	24	8	8			
	5	56	32	16	8				
	4	40	24	8					
19	7	96	64	48	32	16	8	8	
	6	88	56	40	24	8	8		
	5	64	40	24	16	8			
	4	40	24	16	8	8			
18	7	96	72	56	40	24	16	8	8
	6	96	64	48	32	16	8	8	
	5	64	48	32	24	8	8		
	4	40	32	16	16	8			
17	7	96	80	64	48	32	24	16	8
	6	96	72	48	40	24	16	8	8
	5	64	48	40	24	16	8	8	
	4	40	32	24	16	8	8		
16	7	96	96	72	56	48	40	24	16
	6	96	80	64	48	40	24	16	8
	5	64	56	40	32	24	16	8	8
	4	40	40	24	24	16	8	8	
15	7	96	96	80	64	56	48	32	24
	6	96	88	64	56	48	40	24	16
	5	64	64	48	40	32	24	16	8
	4	40	40	32	24	16	16	8	8
14	7	96	96	88	72	64	56	48	40
	6	96	96	72	64	48	40	40	24
	5	72	64	56	40	32	32	24	16
	4	40	40	32	24	24	16	16	8
13	7	96	96	96	80	72	64	56	48
	6	96	96	80	72	56	48	48	40
	5	72	72	56	48	40	32	32	24
	4	48	48	40	32	24	24	16	16
12	7	96	96	96	96	80	72	64	56
	6	96	96	96	80	64	56	48	48
	5	72	72	64	56	48	40	32	32
	4	48	48	40	32	32	24	24	16
11	7	96	96	96	96	88	80	72	64
	6	96	96	96	88	72	64	56	56
	5	72	72	72	64	56	48	40	40
	4	48	48	48	40	32	32	24	24

Table B-32. Reinforcement spacing in inches for 8 inch CMU wall with one reinforcing bar in each reinforced cell.

Wall Ht. Ft.	Bar #	Wind Load, psf							
		5	10	15	20	25	30	35	40
23	7	80	40	16	8				
	6	72	32	8	8				
	5	56	24	8					
	4	32	16	8					
21	7	96	56	40	16	8			
	6	96	56	24	8	8			
	5	80	40	16	8				
	4	48	24	16	8				
19	7	96	80	56	40	16	8	8	
	6	96	72	48	24	16	8	8	
	5	96	56	32	16	8	8		
	4	72	32	24	16	8			
18	7	96	88	64	48	32	16	8	8
	6	96	80	56	40	24	16	8	
	5	96	64	40	24	16	8	8	
	4	80	40	24	16	8	8		
17	7	96	96	72	56	40	24	16	8
	6	96	88	64	48	32	16	8	8
	5	96	72	48	32	24	16	8	8
	4	88	48	32	24	16	8	8	
16	7	96	96	96	72	56	48	32	24
	6	96	96	80	56	48	40	24	16
	5	96	80	56	40	32	24	16	8
	4	96	56	32	24	16	16	8	8
15	7	96	96	96	80	64	56	48	32
	6	96	96	88	64	56	48	32	24
	5	96	96	64	48	40	32	24	16
	4	96	64	40	32	24	16	16	8
14	7	96	96	96	96	72	64	56	48
	6	96	96	96	80	64	48	40	40
	5	96	96	72	56	40	32	32	24
	4	96	72	48	32	24	24	16	16
13	7	96	96	96	96	88	72	64	56
	6	96	96	96	96	72	64	48	48
	5	96	96	88	64	48	40	40	32
	4	96	88	56	40	32	24	24	16
12	7	96	96	96	96	96	88	72	64
	6	96	96	96	96	88	72	64	56
	5	96	96	96	80	64	48	40	40
	4	96	96	64	48	40	32	24	24
11	7	96	96	96	96	96	96	80	72
	6	96	96	96	96	96	88	72	64
	5	96	96	96	96	72	64	56	48
	4	96	96	80	64	48	40	32	32

TM 5-809-3/NAVFAC DM-2.9/AFM 88-3, Chap. 3

Table B-33. Reinforcement spacing in inches for 8 inch CMU wall with one reinforcing bar in each reinforced cell.

Wall Ht. Ft.	Bar #	Wind Load, psf							
		5	10	15	20	25	30	35	40
23	7	56	24	8					
	6	48	16	8					
	5	40	16	8					
	4	24	8						
21	7	72	48	24	8	8			
	6	64	40	16	8				
	5	48	32	8	8				
	4	32	16	8					
19	7	88	56	48	24	16	8		
	6	80	48	32	16	8	8		
	5	56	40	24	16	8			
	4	40	24	16	8				
18	7	96	64	48	32	16	8	8	
	6	88	56	40	24	16	8	8	
	5	64	48	32	16	8	8		
	4	40	24	16	8	8			
17	7	96	72	56	48	24	16	8	8
	6	88	64	48	32	24	16	8	8
	5	64	48	32	24	16	8	8	
	4	40	32	24	16	8	8		
16	7	96	88	72	56	48	32	24	16
	6	88	80	56	48	40	24	16	8
	5	64	56	40	32	24	16	8	8
	4	40	32	24	16	16	8	8	
15	7	96	96	80	64	48	48	32	24
	6	88	80	64	48	40	32	24	16
	5	64	56	48	32	32	24	16	8
	4	40	40	32	24	16	16	8	8
14	7	96	96	88	72	56	48	48	32
	6	88	88	72	56	48	40	32	24
	5	64	64	48	40	32	32	24	16
	4	40	40	32	24	24	16	16	8
13	7	96	96	96	80	64	56	48	48
	6	88	88	80	64	56	48	40	32
	5	64	64	56	48	40	32	32	24
	4	40	40	32	32	24	24	16	16
12	7	96	96	96	88	72	64	56	56
	6	88	88	88	72	64	56	48	40
	5	64	64	64	48	48	40	32	32
	4	40	40	40	32	24	24	24	16
11	7	96	96	96	96	88	72	64	64
	6	88	88	88	80	72	64	56	48
	5	64	64	64	56	48	48	40	32
	4	40	40	40	40	32	24	24	24

Table B-34. Reinforcement spacing in inches for 8 inch CMU wall with one reinforcing bar in each reinforced cell.

Wall Ht. Ft.	Bar #	Wind Load, psf							
		5	10	15	20	25	30	35	40
23	7	48	16	8					
	6	40	16	8					
	5	32	8						
	4	16	8						
21	7	64	40	16	8				
	6	48	32	16	8				
	5	40	24	8	8				
	4	24	16	8					
19	7	64	56	32	16	8	8		
	6	56	48	24	16	8			
	5	40	32	16	8	8			
	4	24	24	8	8				
18	7	64	56	48	24	16	8	8	
	6	56	48	32	16	8	8		
	5	40	40	24	16	8	8		
	4	24	24	16	8	8			
17	7	72	64	48	40	24	16	8	8
	6	56	56	40	24	16	8	8	
	5	40	40	32	16	8	8		
	4	24	24	16	16	8			
16	7	72	72	64	48	40	24	16	8
	6	56	56	48	40	32	16	8	8
	5	40	40	32	32	16	16	8	8
	4	24	24	24	16	16	8	8	
15	7	72	72	64	56	48	32	24	16
	6	56	56	56	48	40	24	16	16
	5	40	40	40	32	24	16	16	8
	4	24	24	24	16	16	8	8	8
14	7	72	72	72	64	56	48	32	24
	6	56	56	56	48	40	40	24	16
	5	40	40	40	32	32	24	16	16
	4	24	24	24	24	16	16	8	8
13	7	72	72	72	64	56	48	48	40
	6	56	56	56	56	48	40	40	24
	5	40	40	40	40	32	32	24	16
	4	24	24	24	24	24	16	16	8
12	7	72	72	72	72	64	56	56	48
	6	64	64	64	64	56	48	40	40
	5	40	40	40	40	40	32	32	24
	4	24	24	24	24	24	24	16	16
11	7	72	72	72	72	72	64	56	56
	6	64	64	64	64	64	56	48	48
	5	40	40	40	40	40	40	32	32
	4	24	24	24	24	24	24	24	16

TM 5-809-3/NAVFAC DM-2.9/AFM 88-3, Chap. 3

Table B-35. Reinforcement spacing in inches for 8 inch CMU wall with one reinforcing bar in each reinforced cell.

Wall Ht. Ft.	Bar #	Wind Load, psf							
		5	10	15	20	25	30	35	40
23	7	64	32	8	8 in. CMU P=2000 lb./ft. e=0 Type S Mortar				
	6	56	24	8					
	5	40	16	8					
	4	32	16	8					
21	7	96	56	24	16	8	8 in. CMU P=2000 lb./ft. e=0 Type S Mortar		
	6	96	48	24	8	8			
	5	72	32	16	8	8			
	4	48	24	8	8	8			
19	7	96	72	48	32	16	8	8	
	6	96	64	48	24	8	8		
	5	96	48	32	16	8	8		
	4	64	32	24	8	8			
18	7	96	80	56	48	24	16	8	8
	6	96	72	48	32	16	8	8	
	5	96	56	40	24	16	8		
	4	72	40	24	16	8			
17	7	96	96	64	48	40	24	16	8
	6	96	88	56	40	24	16	8	8
	5	96	64	40	32	16	8	8	
	4	88	40	24	16	16	8		
16	7	96	96	88	64	56	40	24	16
	6	96	96	72	56	40	32	24	16
	5	96	80	48	40	32	24	16	8
	4	96	48	32	24	16	16	8	8
15	7	96	96	96	80	64	48	40	32
	6	96	96	88	64	48	40	32	24
	5	96	88	64	48	32	32	24	16
	4	96	56	40	32	24	16	16	8
14	7	96	96	96	88	72	56	48	40
	6	96	96	96	72	56	48	40	32
	5	96	96	72	56	40	32	32	24
	4	96	72	48	32	24	24	16	16
13	7	96	96	96	96	80	72	56	48
	6	96	96	96	88	72	56	48	40
	5	96	96	80	64	48	40	32	32
	4	96	80	56	40	32	24	24	16
12	7	96	96	96	96	96	80	72	64
	6	96	96	96	96	80	72	56	48
	5	96	96	96	72	56	48	40	32
	4	96	96	64	48	40	32	24	24
11	7	96	96	96	96	96	96	80	72
	6	96	96	96	96	96	80	72	64
	5	96	96	96	88	72	56	48	40
	4	96	96	80	56	48	40	32	24

Table B-36. Reinforcement spacing in inches for 8 inch CMU wall with one reinforcing bar in each reinforced cell.

Wall Ht. Ft.	Bar #	Wind Load, psf							
		5	10	15	20	25	30	35	40
23	7	48	16	8					
	6	40	8	8					
	5	24	8						
	4	16	8						
21	7	56	32	16	8				
	6	48	24	8	8				
	5	40	16	8					
	4	24	16	8					
19	7	64	48	32	16	8	8		
	6	56	48	24	16	8	8		
	5	40	32	16	8	8			
	4	24	24	8	8				
18	7	72	56	40	24	16	8	8	
	6	56	48	32	16	8	8		
	5	40	40	24	16	8			
	4	24	24	16	8	8			
17	7	72	64	48	32	16	8	8	8
	6	56	56	40	24	16	8	8	
	5	40	40	32	16	8	8		
	4	24	24	16	8	8			
16	7	72	72	56	48	40	24	16	8
	6	64	64	48	40	24	16	8	8
	5	40	40	32	24	16	16	8	8
	4	24	24	24	16	16	8	8	
15	7	72	72	64	56	48	32	24	16
	6	64	64	56	48	40	24	16	8
	5	40	40	40	32	24	16	8	8
	4	24	24	24	16	16	8	8	8
14	7	72	72	72	64	48	48	32	24
	6	64	64	56	48	40	32	24	16
	5	48	48	40	32	32	24	16	16
	4	24	24	24	24	16	16	8	8
13	7	72	72	72	64	56	48	48	32
	6	64	64	64	56	48	40	32	24
	5	48	48	48	40	32	32	24	16
	4	32	32	32	24	24	18	16	8
12	7	72	72	72	72	64	56	48	48
	6	64	64	64	64	56	48	40	40
	5	48	48	48	40	40	32	32	24
	4	32	32	32	24	24	24	16	16
11	7	80	80	80	80	72	64	56	56
	6	64	64	64	64	64	56	48	48
	5	48	48	48	48	40	40	32	32
	4	32	32	32	32	24	24	24	16

TM 5-809-3/NAVFAC DM-2.9/AFM 88-3, Chap. 3

Table B-37. Reinforcement spacing in inches for 8 inch CMU wall with one reinforcing bar in each reinforced cell.

Wall Ht. Ft.	Bar #	Wind Load, psf							
		5	10	15	20	25	30	35	40
23	7	24	8	8					
	6	16	8						
	5	16	8						
	4	8	8						
21	7	40	24	8	8				
	6	24	16	8					
	5	24	16	8					
	4	16	8						
19	7	48	48	24	8	8			
	6	32	32	16	8	8			
	5	24	24	16	8				
	4	16	16	8					
18	7	48	48	32	16	8	8		
	6	40	40	24	16	8	8		
	5	24	24	16	8	8			
	4	16	16	8	8				
17	7	48	48	40	24	16	8	8	
	6	40	40	32	16	8	8	8	
	5	24	24	24	16	8	8		
	4	16	16	16	8	8			
16	7	48	48	48	40	24	16	8	8
	6	40	40	40	32	16	16	8	8
	5	24	24	24	24	16	8	8	
	4	16	16	16	16	8	8		
15	7	48	48	48	48	32	24	16	8
	6	40	40	40	40	24	16	16	8
	5	32	32	32	24	16	16	8	8
	4	16	16	16	16	8	8	8	
14	7	48	48	48	48	48	32	24	16
	6	40	40	40	40	32	24	16	16
	5	32	32	32	32	24	16	16	8
	4	16	16	16	16	16	8	8	8
13	7	48	48	48	48	48	48	32	24
	6	40	40	40	40	40	32	24	16
	5	32	32	32	32	32	24	16	16
	4	16	16	16	16	16	16	8	8
12	7	48	48	48	48	48	48	48	40
	6	40	40	40	40	40	40	32	24
	5	32	32	32	32	32	24	24	16
	4	16	16	16	16	16	16	16	8
11	7	48	48	48	48	48	48	48	48
	6	40	40	40	40	40	40	40	40
	5	32	32	32	32	32	32	32	24
	4	16	16	16	16	16	16	16	16

Table B-38. Reinforcement spacing in inches for 12 inch CMU wall with one reinforcing bar in each reinforced cell.

Wall Ht. Ft.	Bar #	Wind Load, psf								
		5	10	15	20	25	30	35	40	
33	7	96	56	32	8	8	12 in. CMU P=0 lb./ft. e=0 Type S Mortar			
	6	88	40	24	8	8				
	5	56	32	16	8	8				
	4	40	16	8						
30	7	96	72	48	32	16				
	6	96	56	32	24	8				
	5	80	40	24	16	8				
	4	48	24	16	8					
28	7	96	80	56	40	24				
	6	96	64	40	32	16				
	5	96	48	32	16	8				
	4	56	24	16	8	8				
26	7	96	96	64	48	40				
	6	96	72	48	32	24				
	5	96	56	32	24	16				
	4	72	32	24	16	8				
24	7	96	96	80	64	48				
	6	96	96	64	48	32				
	5	96	64	40	32	24				
	4	88	40	24	16	16				
22	7	96	96	96	72	56				
	6	96	96	72	56	40				
	5	96	80	48	40	32				
	4	96	48	32	24	16				
20	7	96	96	96	96	72				
	6	96	96	88	64	56				
	5	96	96	64	48	40				
	4	96	64	40	32	24				
18	7	96	96	96	96	88				
	6	96	96	96	88	64				
	5	96	96	80	56	48				
	4	96	80	48	40	32				
16	7	96	96	96	96	96				
	6	96	96	96	96	88				
	5	96	96	96	80	64				
	4	96	96	64	48	40				
14	7	96	96	96	96	96				
	6	96	96	96	96	96				
	5	96	96	96	96	80				
	4	96	96	88	64	48				
12	7	96	96	96	96	96				
	6	96	96	96	96	96				
	5	96	96	96	96	96				
	4	96	96	96	88	72				

TM 5-809-3/NAVFAC DM-2.9/AFM 88-3, Chap. 3

Table B-39. Reinforcement spacing in inches for 12 inch CMU wall with one reinforcing bar in each reinforced cell.

Wall Ht. Ft.	Bar #	Wind Load, psf							
		5	10	15	20	25	30	35	40
33	7	96	48	24	8	8	12 in. CMU P=500 lb./ft. e=0 Type S Mortar		
	6	80	40	16	8				
	5	56	24	16	8				
	4	32	16	8					
30	7	96	64	40	24	8			
	6	96	48	32	16	8			
	5	72	32	24	8	8			
	4	48	24	16	8				
28	7	96	80	48	40	24	8	8	
	6	96	64	40	24	16	8	8	
	5	88	40	24	16	8	8		
	4	56	24	16	8	8			
26	7	96	88	64	48	32	24	8	8
	6	96	72	48	32	24	16	8	8
	5	96	48	32	24	16	8	8	
	4	64	32	24	16	8	8		
24	7	96	96	80	56	48	40	24	16
	6	96	88	56	40	32	24	16	16
	5	96	64	40	32	24	16	16	8
	4	80	40	24	16	16	8	8	8
22	7	96	96	96	72	56	48	40	32
	6	96	96	72	56	40	32	32	24
	5	96	80	48	40	32	24	16	16
	4	96	48	32	24	16	16	8	8
20	7	96	96	96	88	72	56	48	40
	6	96	96	88	64	48	40	32	32
	5	96	96	64	48	32	32	24	24
	4	96	64	40	32	24	16	16	8
18	7	96	96	96	96	88	72	64	56
	6	96	96	96	80	64	56	48	40
	5	96	96	80	56	48	40	32	24
	4	96	72	48	40	24	24	16	16
16	7	96	96	96	96	96	96	80	72
	6	96	96	96	96	80	72	56	48
	5	96	96	96	72	56	48	40	32
	4	96	96	64	48	40	32	24	24
14	7	96	96	96	96	96	96	96	88
	6	96	96	96	96	96	88	80	72
	5	96	96	96	96	80	64	56	48
	4	96	96	88	64	48	40	32	32
12	7	96	96	96	96	96	96	96	96
	6	96	96	96	96	96	96	96	96
	5	96	96	96	96	96	88	80	64
	4	96	96	96	88	72	56	48	40

Table B-40. Reinforcement spacing in inches for 12 inch CMU wall with one reinforcing bar in each reinforced cell.

Wall Ht. Ft.	Bar #	Wind Load, psf								
		5	10	15	20	25	30	35	40	
33	7	88	48	24	8	8	12 in. CMU P=500 lb./ft. e=t/3 Type S Mortar			
	6	72	32	16	8	8				
	5	48	24	8	8					
	4	32	16	8						
30	7	96	56	40	24	8				
	6	88	48	32	16	8				
	5	64	32	16	8	8				
	4	40	24	8	8					
28	7	96	72	48	32	16	8	8		
	6	96	56	32	24	16	8			
	5	72	40	24	16	8	8			
	4	48	24	16	8	8				
26	7	96	80	56	40	32	16	8	8	
	6	96	64	48	32	24	16	8	8	
	5	88	48	32	24	16	8	8		
	4	56	32	16	16	8	8			
24	7	96	96	72	56	48	40	24	16	
	6	96	80	56	40	32	24	16	8	
	5	96	56	40	24	24	16	8	8	
	4	64	32	24	16	16	8	8		
22	7	96	96	88	64	56	48	40	32	
	6	96	96	64	48	40	32	24	24	
	5	96	64	48	32	24	24	16	16	
	4	80	40	32	24	16	16	8	8	
20	7	96	96	96	80	64	56	48	40	
	6	96	96	80	56	48	40	32	32	
	5	96	80	56	40	32	24	24	16	
	4	88	48	32	24	24	16	16	8	
18	7	96	96	96	96	80	72	56	48	
	6	96	96	96	72	56	48	40	40	
	5	96	96	64	48	40	32	32	24	
	4	96	64	40	32	24	24	16	16	
16	7	96	96	96	96	96	88	72	64	
	6	96	96	96	96	72	64	56	48	
	5	96	96	88	64	56	48	40	32	
	4	96	80	56	40	32	24	24	16	
14	7	96	96	96	96	96	96	96	80	
	6	96	96	96	96	96	80	72	64	
	5	96	96	96	80	72	56	48	40	
	4	96	96	72	56	40	40	32	24	
12	7	96	96	96	96	96	96	96	96	
	6	96	96	96	96	96	96	96	88	
	5	96	96	96	96	88	80	64	56	
	4	96	96	88	72	56	48	40	40	

TM 5-809-3/NAVFAC DM-2.9/AFM 88-3, Chap. 3

Table B-41. Reinforcement spacing in inches for 12 inch CMU wall with one reinforcing bar in each reinforced cell.

Wall Ht. Ft.	Bar #	Wind Load, psf							
		5	10	15	20	25	30	35	40
33	7	80	48	24	8				
	6	64	32	16	8				
	5	48	24	8	8				
	4	32	16	8					
30	7	96	56	40	24	8			
	6	88	48	32	16	8			
	5	56	32	16	8	8			
	4	40	16	8	8				
28	7	96	72	48	32	16	8	8	
	6	96	56	32	24	16	8		
	5	72	40	24	16	8	8		
	4	48	24	16	8	8			
26	7	96	80	56	40	32	16	8	8
	6	96	64	40	32	24	16	8	8
	5	80	48	32	24	16	8	8	
	4	56	24	16	16	8	8		
24	7	96	96	72	56	40	32	24	16
	6	96	72	56	40	32	24	16	8
	5	96	56	40	24	24	16	8	8
	4	64	32	24	16	16	8	8	
22	7	96	96	88	64	56	40	40	32
	6	96	88	64	48	40	32	24	24
	5	96	64	40	32	24	24	16	16
	4	72	40	24	16	16	16	8	8
20	7	96	96	96	80	64	56	48	40
	6	96	96	72	56	48	40	32	32
	5	96	72	56	40	32	24	24	16
	4	80	48	32	24	16	16	16	8
18	7	96	96	96	96	80	64	56	48
	6	96	96	88	72	56	48	40	32
	5	96	88	64	48	40	32	32	24
	4	88	56	40	32	24	24	16	16
16	7	96	96	96	96	96	80	72	64
	6	96	96	96	88	72	64	56	48
	5	96	96	80	64	48	40	40	32
	4	96	72	48	40	32	24	24	16
14	7	96	96	96	96	96	96	96	80
	6	96	96	96	96	88	80	72	64
	5	96	96	96	80	64	56	48	40
	4	96	80	64	48	40	32	32	24
12	7	96	96	96	96	96	96	96	96
	6	96	96	96	96	96	96	88	80
	5	96	96	96	96	80	72	64	56
	4	96	96	80	64	56	48	40	32

Table B-42. Reinforcement spacing in inches for 12 inch CMU wall with one reinforcing bar in each reinforced cell.

Wall Ht. Ft.	Bar #	Wind Load, psf							
		5	10	15	20	25	30	35	40
33	7	88	48	16	8				
	6	72	32	16	8				
	5	48	24	8	8				
	4	32	16	8					
30	7	96	56	40	24	8			
	6	96	48	32	16	8			
	5	64	32	16	8	8			
	4	48	24	16	8				
28	7	96	72	48	32	16	8	8	
	6	96	56	40	24	16	8		
	5	80	40	24	16	8	8		
	4	56	24	16	8	8			
26	7	96	88	56	40	32	16	8	8
	6	96	72	48	32	24	16	8	8
	5	96	48	32	24	16	8	8	
	4	64	32	16	16	8	8		
24	7	96	96	72	56	48	40	24	16
	6	96	88	56	40	32	24	16	8
	5	96	56	40	32	24	16	16	8
	4	80	40	24	16	16	8	8	8
22	7	96	96	96	72	56	48	40	32
	6	96	96	72	48	40	32	24	24
	5	96	72	48	32	24	24	16	16
	4	96	48	32	24	16	16	8	8
20	7	96	96	96	88	64	56	48	40
	6	96	96	88	64	48	40	32	32
	5	96	88	56	40	32	24	24	16
	4	96	56	40	24	24	16	16	8
18	7	96	96	96	96	88	72	56	56
	6	96	96	96	80	64	48	40	40
	5	96	96	72	56	40	32	32	24
	4	96	72	48	32	24	24	16	16
16	7	96	96	96	96	96	88	80	64
	6	96	96	96	96	80	64	56	48
	5	96	96	96	72	56	48	40	32
	4	96	96	64	48	32	32	24	24
14	7	96	96	96	96	96	96	96	88
	6	96	96	96	96	96	88	72	64
	5	96	96	96	96	72	64	56	48
	4	96	96	80	64	48	40	32	32
12	7	96	96	96	96	96	96	96	96
	6	96	96	96	96	96	96	96	88
	5	96	96	96	96	96	88	72	64
	4	96	96	96	88	64	56	48	40

TM 5-809-3/NAVFAC DM-2.9/AFM 88-3, Chap. 3

Table B-43. Reinforcement spacing in inches for 12 inch CMU wall with one reinforcing bar in each reinforced cell.

Wall Ht. Ft.	Bar #	Wind Load, psf							
		5	10	15	20	25	30	35	40
33	7	72	40	16	8		12 in. CMU P=1000 lb./ft. e=t/3 Type S Mortar		
	6	56	32	8	8				
	5	40	24	8					
	4	24	16	8					
30	7	88	56	32	16	8			
	6	72	40	24	8	8			
	5	56	32	16	8				
	4	32	16	8	8				
28	7	96	64	40	32	16	8	8	
	6	88	48	32	24	8	8		
	5	64	32	24	16	8			
	4	40	24	16	8	8			
26	7	96	72	48	40	24	16	8	8
	6	96	56	40	32	16	8	8	
	5	72	40	24	16	16	8	8	
	4	48	24	16	8	8	8		
24	7	96	96	64	48	40	32	24	16
	6	96	72	48	40	32	24	16	8
	5	80	48	32	24	16	16	8	8
	4	56	32	24	16	8	8	8	
22	7	96	96	80	64	48	40	32	24
	6	96	80	56	48	32	32	24	16
	5	96	56	40	32	24	16	16	8
	4	64	32	24	16	16	8	8	8
20	7	96	96	96	72	56	48	40	40
	6	96	96	72	56	40	40	32	24
	5	96	64	48	40	32	24	24	16
	4	64	40	32	24	16	16	16	8
18	7	96	96	96	88	72	64	56	48
	6	96	96	80	64	56	48	40	32
	5	96	80	56	48	40	32	24	24
	4	72	48	40	32	24	16	16	16
16	7	96	96	96	96	88	80	64	56
	6	96	96	96	80	64	56	48	40
	5	96	96	72	56	48	40	32	32
	4	72	56	48	32	32	24	24	16
14	7	96	96	96	96	96	96	88	80
	6	96	96	96	96	80	72	64	56
	5	96	96	88	72	56	48	40	40
	4	72	72	56	48	40	32	24	24
12	7	96	96	96	96	96	96	96	88
	6	96	96	96	96	96	96	80	72
	5	96	96	96	88	72	64	56	48
	4	72	72	64	56	48	40	40	32

Table B-44. Reinforcement spacing in inches for 12 inch CMU wall with one reinforcing bar in each reinforced cell.

Wall Ht. Ft.	Bar #	Wind Load, psf							
		5	10	15	20	25	30	35	40
33	7	64	40	16	8				
	6	48	24	8	8				
	5	40	16	8					
	4	24	8	8					
30	7	80	48	32	16	8			
	6	64	40	24	8	8			
	5	48	24	16	8				
	4	32	16	8	8				
28	7	96	56	40	24	16	8	8	
	6	80	48	32	16	8	8		
	5	56	32	24	16	8			
	4	32	16	16	8				
26	7	96	64	48	40	24	16	8	8
	6	88	56	40	24	16	8	8	
	5	64	40	24	16	8	8		
	4	40	24	16	8	8			
24	7	96	88	64	48	40	32	16	8
	6	96	64	48	32	24	24	16	8
	5	72	40	32	24	16	16	8	8
	4	48	24	16	16	8	8	8	
22	7	96	96	72	56	48	40	32	24
	6	96	72	56	40	32	32	24	16
	5	72	48	40	32	24	16	16	8
	4	48	32	24	16	16	8	8	8
20	7	96	96	88	64	56	48	40	40
	6	96	80	64	48	40	32	32	24
	5	72	56	40	32	24	24	16	16
	4	48	40	24	24	16	16	8	8
18	7	96	96	96	80	64	56	48	48
	6	96	96	72	56	48	40	40	32
	5	72	64	48	40	32	32	24	24
	4	48	40	32	24	24	16	16	16
16	7	96	96	96	96	80	72	64	56
	6	96	96	88	72	64	56	48	40
	5	72	72	64	48	40	40	32	24
	4	48	48	40	32	24	24	16	16
14	7	96	96	96	96	96	88	80	72
	6	96	96	96	88	72	64	56	48
	5	72	72	72	64	56	48	40	32
	4	48	48	48	40	32	32	24	24
12	7	96	96	96	96	96	96	96	8
	6	96	96	96	96	88	80	72	64
	5	72	72	72	72	64	56	48	48
	4	48	48	48	48	40	40	32	32

TM 5-809-3/NAVFAC DM-2.9/AFM 88-3, Chap. 3

Table B-45. Reinforcement spacing in inches for 12 inch CMU wall with one reinforcing bar in each reinforced cell.

Wall Ht. Ft.	Bar #	Wind Load, psf							
		5	10	15	20	25	30	35	40
33	7	80	40	16	8				
	6	64	32	16	8				
	5	48	24	8					
	4	32	16	8					
30	7	96	56	40	16	8			
	6	88	48	24	16	8			
	5	64	32	16	8	8			
	4	40	16	8	8				
28	7	96	64	48	32	16	8	8	
	6	96	56	32	24	8	8		
	5	80	40	24	16	8	8		
	4	48	24	16	8	8			
26	7	96	80	56	40	24	16	8	8
	6	96	64	40	32	24	8	8	8
	5	96	48	32	24	16	8	8	
	4	64	32	16	16	8	8		
24	7	96	96	72	56	40	32	24	16
	6	96	80	56	40	32	24	16	8
	5	96	56	40	24	24	16	8	8
	4	72	40	24	16	16	8	8	
22	7	96	96	88	64	56	40	40	24
	6	96	96	64	48	40	32	24	16
	5	96	72	48	32	24	24	16	16
	4	88	48	32	24	16	16	8	8
20	7	96	96	96	80	64	56	48	40
	6	96	96	80	56	48	40	32	32
	5	96	88	56	40	32	24	24	16
	4	96	56	40	24	24	16	16	8
18	7	96	96	96	96	80	64	56	48
	6	96	96	96	72	56	48	40	40
	5	96	96	72	56	40	32	32	24
	4	96	72	48	32	24	24	16	16
16	7	96	96	96	96	96	88	72	64
	6	96	96	96	96	80	64	56	48
	5	96	96	96	72	56	48	40	32
	4	96	88	56	48	32	32	24	24
14	7	96	96	96	96	96	96	96	88
	6	96	96	96	96	96	88	72	64
	5	96	96	96	88	72	64	48	48
	4	96	96	80	56	48	40	32	24
12	7	96	96	96	96	96	96	96	96
	6	96	96	96	96	96	96	96	88
	5	96	96	96	96	96	80	72	64
	4	96	96	96	80	64	56	48	40

Table B-46. Reinforcement spacing in inches for 12 inch CMU wall with one reinforcing bar in each reinforced cell.

Wall Ht. Ft.	Bar #	Wind Load, psf							
		5	10	15	20	25	30	35	40
33	7	64	32	8	8				
	6	48	24	8					
	5	32	16	8					
	4	24	8	8					
30	7	80	48	24	16	8			
	6	64	32	16	8	8			
	5	48	24	16	8				
	4	32	16	8					
28	7	88	56	40	24	8	8		
	6	72	40	24	16	8	8		
	5	48	32	16	8	8			
	4	32	16	8	8				
26	7	96	64	48	32	16	8	8	8
	6	80	48	32	24	16	8	8	
	5	56	32	24	16	8	8		
	4	40	24	16	8	8			
24	7	96	80	56	48	40	24	16	8
	6	96	56	40	32	24	16	8	8
	5	64	40	32	24	16	16	8	8
	4	40	24	16	16	8	8	8	
22	7	96	96	72	56	48	40	32	16
	6	96	72	48	40	32	24	24	16
	5	64	48	32	24	24	16	16	8
	4	40	32	24	16	16	8	8	8
20	7	96	96	80	64	56	48	40	32
	6	96	80	56	48	40	32	32	24
	5	72	56	40	32	24	24	16	16
	4	40	32	24	24	16	16	8	8
18	7	96	96	96	80	64	56	48	40
	6	96	88	72	56	48	40	32	32
	5	72	64	48	40	32	24	24	24
	4	48	40	32	24	24	16	16	16
16	7	96	96	96	96	80	72	64	56
	6	96	96	80	72	56	48	48	40
	5	72	72	56	48	40	32	32	24
	4	48	48	40	32	24	24	16	16
14	7	96	96	96	96	96	88	72	72
	6	96	96	96	80	72	64	56	48
	5	72	72	72	56	48	40	40	32
	4	48	48	48	40	32	24	24	24
12	7	96	96	96	96	96	96	96	88
	6	96	96	96	96	88	80	72	64
	5	72	72	72	72	64	56	48	48
	4	48	48	48	48	40	32	32	32

TM 5-809-3/NAVFAC DM-2.9/AFM 88-3, Chap. 3

Table B-47. Reinforcement spacing in inches for 12 inch CMU wall with one reinforcing bar in each reinforced cell.

Wall Ht. Ft.	Bar #	Wind Load, psf							
		5	10	15	20	25	30	35	40
33	7	56	24	8	8		12 in. CMU P=1500 lb./ft. e=t/2 Type S Mortar		
	6	40	16	8					
	5	32	16	8					
	4	16	8						
30	7	64	40	24	8	8			
	6	56	32	16	8	8			
	5	40	24	8	8				
	4	24	16	8					
28	7	80	48	32	16	8	8		
	6	64	40	24	16	8			
	5	40	24	16	8	8			
	4	24	16	8	8				
26	7	80	56	40	32	16	8	8	
	6	64	48	32	24	16	8	8	
	5	40	32	24	16	8	8		
	4	24	16	16	8	8			
24	7	88	72	56	40	32	24	16	8
	6	64	56	40	32	24	16	8	8
	5	48	40	24	24	16	8	8	8
	4	24	24	16	16	8	8		
22	7	88	80	64	48	40	32	24	16
	6	64	56	48	40	32	24	16	16
	5	48	40	32	24	24	16	16	8
	4	24	24	16	16	16	8	8	8
20	7	88	88	72	56	48	40	40	32
	6	64	64	56	40	32	32	24	24
	5	48	48	40	32	24	24	16	16
	4	32	32	24	16	16	16	8	8
18	7	88	88	80	72	56	48	48	40
	6	64	64	64	48	40	40	32	32
	5	48	48	40	32	32	24	24	16
	4	32	32	24	24	16	16	16	8
16	7	88	88	88	80	72	64	56	48
	6	64	64	64	56	48	48	40	32
	5	48	48	48	40	32	32	24	24
	4	32	32	32	24	24	16	16	16
14	7	88	88	88	88	80	72	64	64
	6	64	64	64	64	64	56	48	48
	5	48	48	48	48	40	40	32	32
	4	32	32	32	32	24	24	24	16
12	7	88	88	88	88	88	88	80	72
	6	64	64	64	64	64	64	64	56
	5	48	48	48	48	48	48	40	40
	4	32	32	32	32	32	32	24	24

Table B-48. Reinforcement spacing in inches for 12 inch CMU wall with one reinforcing bar in each reinforced cell.

Wall Ht. Ft.	Bar #	Wind Load, psf							
		5	10	15	20	25	30	35	40
33	7	72	40	16	8				
	6	56	32	8	8				
	5	40	24	8					
	4	24	16	8					
30	7	96	56	32	16	8			
	6	80	40	24	8	8			
	5	56	32	16	8				
	4	40	16	8	8				
28	7	96	64	40	24	16	8	8	
	6	96	48	32	16	8	8		
	5	72	32	24	16	8			
	4	48	24	16	8	8			
26	7	96	80	56	40	24	16	8	8
	6	96	64	40	24	16	8	8	
	5	88	48	32	16	16	8	8	
	4	56	32	16	8	8	8		
24	7	96	96	72	48	40	32	24	16
	6	96	80	48	40	32	24	16	8
	5	96	56	32	24	24	16	8	8
	4	72	32	24	16	16	8	8	
22	7	96	96	88	64	48	40	32	24
	6	96	96	64	48	40	32	24	16
	5	96	64	48	32	24	24	16	16
	4	88	40	24	24	16	16	8	8
20	7	96	96	96	80	64	48	48	40
	6	96	96	80	56	48	40	32	24
	5	96	80	56	40	32	24	24	16
	4	96	56	32	24	16	16	16	8
18	7	96	96	96	96	80	64	56	48
	6	96	96	96	72	56	48	40	32
	5	96	96	72	48	40	32	32	24
	4	96	64	48	32	24	24	16	16
16	7	96	96	96	96	96	80	72	64
	6	96	96	96	96	72	64	56	48
	5	96	96	88	64	56	40	40	32
	4	96	88	56	40	32	24	24	16
14	7	96	96	96	96	96	96	96	80
	6	96	96	96	96	96	80	72	64
	5	96	96	96	88	72	56	48	40
	4	96	96	80	56	48	40	32	24
12	7	96	96	96	96	96	96	96	96
	6	96	96	96	96	96	96	96	88
	5	96	96	96	96	96	80	72	56
	4	96	96	96	80	64	48	48	40

TM 5-809-3/NAVFAC DM-2.9/AFM 88-3, Chap. 3

Table B-49. Reinforcement spacing in inches for 12 inch CMU wall with one reinforcing bar in each reinforced cell.

Wall Ht. Ft.	Bar #	Wind Load, psf							
		5	10	15	20	25	30	35	40
33	7	48	24	8	8			12 in. CMU P=2000 lb./ft. e=t/3 Type S Mortar	
	6	40	16	8					
	5	24	16	8					
	4	16	8						
30	7	64	40	16	8	8			
	6	56	32	16	8	8			
	5	40	24	8	8				
	4	24	16	8					
28	7	80	48	32	16	8	8		
	6	64	40	24	16	8			
	5	40	24	16	8	8			
	4	24	16	8	8				
26	7	88	56	40	24	16	8	8	
	6	64	48	32	24	8	8	8	
	5	48	32	24	16	8	8		
	4	32	16	16	8	8			
24	7	88	72	56	40	32	24	16	8
	6	64	56	40	32	24	16	8	8
	5	48	40	24	24	16	8	8	8
	4	32	24	16	16	8	8		
22	7	88	80	64	48	40	32	24	16
	6	64	56	48	32	32	24	16	8
	5	48	40	32	24	24	16	16	8
	4	32	24	16	16	16	8	8	8
20	7	88	88	72	56	48	40	40	32
	6	64	64	56	40	32	32	24	24
	5	48	48	40	32	24	24	16	16
	4	32	32	24	16	16	16	8	8
18	7	96	96	80	72	56	48	48	40
	6	72	72	64	48	40	40	32	32
	5	48	48	40	32	32	24	24	16
	4	32	32	24	24	16	16	16	8
16	7	96	96	96	80	72	64	56	48
	6	72	72	72	56	48	48	40	32
	5	48	48	48	40	32	32	24	24
	4	32	32	32	24	24	16	16	16
14	7	96	96	96	96	80	72	64	64
	6	72	72	72	72	64	56	48	48
	5	48	48	48	48	40	40	32	32
	4	32	32	32	32	24	24	24	16
12	7	96	96	96	96	96	88	80	80
	6	72	72	72	72	72	64	64	56
	5	48	48	48	48	48	48	40	40
	4	32	32	32	32	32	32	24	24

Table B-50. Reinforcement spacing in inches for 12 inch CMU wall with one reinforcing bar in each reinforced cell.

Wall Ht. Ft.	Bar #	Wind Load, psf							
		5	10	15	20	25	30	35	40
33	7	48	16	8					
	6	32	16	8					
	5	24	8	8					
	4	16	8						
30	7	56	32	16	8	8			
	6	40	24	16	8				
	5	32	16	8	8				
	4	16	8	8					
28	7	56	40	24	16	8	8		
	6	40	32	16	8	8			
	5	32	24	16	8				
	4	16	16	8	8				
26	7	56	48	40	24	16	8	8	
	6	40	40	24	16	8	8		
	5	32	24	16	8	8			
	4	16	16	8	8				
24	7	56	56	48	40	24	16	8	8
	6	40	40	32	24	24	16	8	8
	5	32	32	24	16	16	8	8	
	4	16	16	16	8	8	8		
22	7	64	64	56	48	40	32	16	16
	6	48	48	40	32	24	24	16	8
	5	32	32	24	24	16	16	8	8
	4	16	16	16	16	8	8	8	
20	7	64	64	64	48	40	40	32	24
	6	48	48	48	40	32	24	24	16
	5	32	32	32	24	24	16	16	8
	4	16	16	16	16	16	8	8	8
18	7	64	64	64	56	48	48	40	40
	6	48	48	48	40	40	32	32	24
	5	32	32	32	32	24	24	16	16
	4	16	16	16	16	16	16	8	8
16	7	64	64	64	64	56	56	48	48
	6	48	48	48	48	40	40	32	32
	5	32	32	32	32	32	24	24	24
	4	16	16	16	16	16	16	16	16
14	7	64	64	64	64	64	64	56	56
	6	48	48	48	48	48	48	40	40
	5	32	32	32	32	32	32	32	24
	4	16	16	16	16	16	16	16	16
12	7	64	64	64	64	64	64	64	64
	6	48	48	48	48	48	48	48	48
	5	32	32	32	32	32	32	32	32
	4	16	16	16	16	16	16	16	16

APPENDIX C

LINTEL DESIGN AIDS

C-1. This appendix contains tables that can be used in the design of concrete masonry lintels.

Table C-1. 6" CMU lintel 8" deep—1 bar Type S mortar

b = 5.62 in
d = 4.62 in $f'_m = 1,350$ psi
 $F_s = 24,000$ psi

Reinf	As in ²	kd in	p	I _{cr} in ⁴	M _{rm} ft-lb	M _{rs} ft-lb	V lb
1-#4	0.20	2.00	0.0077	44	834	1,581	954
1-#5	0.31	2.33	0.0119	59	944	2,383	
1-#6	0.44	2.60	0.0169	71	1,030	3,302	
1-#7	0.60	2.85	0.0231	84	1,102	4,411	
1-#8	0.79	3.06	0.0304	95	1,162	5,686	

Table C-2. 6" CMU lintel 16" deep—1 bar Type S mortar

b = 5.62 in
d = 12.62 in $f'_m = 1,350$ psi
 $F_s = 24,000$ psi

Reinf	As in ²	kd in	p	I _{cr} in ⁴	M _{rm} ft-lb	M _{rs} ft-lb	V lb
1-#4	0.20	3.69	0.0028	437	4,433	4,555	2,606
1-#5	0.31	4.41	0.0044	610	5,182	6,913	
1-#6	0.44	5.05	0.0062	783	5,817	9,625	
1-#7	0.60	5.66	0.0085	965	6,398	12,903	
1-#8	0.79	6.22	0.0111	1,146	6,911	16,665	

Table C-3. 6" CMU lintel 24" deep—1 bar Type S mortar

b = 5.62 in
d = 20.62 in $f'_m = 1,350$ psi
 $F_s = 24,000$ psi

Reinf	As in ²	kd in	p	I _{cr} in ⁴	M _{rm} ft-lb	M _{rs} ft-lb	V lb
1-#4	0.20	4.90	0.0017	1,282	9,808	7,594	4,258
1-#5	0.31	5.91	0.0027	1,828	11,606	11,564	
1-#6	0.44	6.81	0.0038	2,394	13,176	16,147	
1-#7	0.60	7.70	0.0052	3,010	14,654	21,699	
1-#8	0.79	8.54	0.0068	3,643	15,996	28,081	

Table C-4. 6" CMU lintel 32" deep—1 bar Type S mortar

b = 5.62 in
d = 28.62 in $f'_m = 1,350$ psi
 $F_s = 24,000$ psi

Reinf	As in ²	kd in	p	I _{cr} in ⁴	M _{rm} ft-lb	M _{rs} ft-lb	V lb
1-#4	0.20	5.89	0.0012	2,602	16,557	10,662	5,910
1-#5	0.31	7.14	0.0019	3,754	19,731	16,270	
1-#6	0.44	8.27	0.0027	4,974	22,546	22,759	
1-#7	0.60	9.40	0.0037	6,325	25,240	30,636	
1-#8	0.79	10.47	0.0049	7,741	27,725	39,706	

Table C-5. 6" CMU lintel 40" deep—1 bar Type S mortar

b = 5.62 in
d = 36.62 in $f'_m = 1,350$ psi
 $F_s = 24,000$ psi

Reinf	As in ²	kd in	p	I _{cr} in ⁴	M _{rm} ft-lb	M _{rs} ft-lb	V lb
1-#4	0.20	6.76	0.0010	4,409	24,471	13,747	7,562
1-#5	0.31	8.21	0.0015	6,412	29,300	21,009	
1-#6	0.44	9.54	0.0021	8,558	33,627	29,426	
1-#7	0.60	10.88	0.0029	10,966	37,813	39,660	
1-#8	0.79	12.16	0.0038	13,522	41,715	51,458	

TM 5-809-3/NAVFAC DM-2.9/AFM 88-3, Chap. 3

Table C-6. 6" CMU lintel 48" deep—1 bar Type S mortar

b = 5.62 in
d = 44.62 in

$f_m = 1,350$ psi
 $F_s = 24,000$ psi

Reinf	As in ²	kd in	p	Icr in ⁴	Mrm ft-lb	Mrs ft-lb	V lb
1-#4	0.20	7.53	0.0008	6,710	33,415	16,844	9,214
1-#5	0.31	9.17	0.0012	9,813	40,147	25,770	
1-#6	0.44	10.68	0.0018	13,170	46,225	36,132	
1-#7	0.60	12.20	0.0024	16,971	52,149	48,744	
1-#8	0.79	13.67	0.0032	21,041	57,716	63,299	

Table C-7. 8" CMU lintel 8" deep—2 bars Type S mortar

b = 7.62 in
d = 4.62 in

$f_m = 1,350$ psi
 $F_s = 24,000$ psi

Reinf	As in ²	kd in	p	Icr in ⁴	Mrm ft-lb	Mrs ft-lb	V lb
2-#4	0.40	2.29	0.0114	77	1,263	3,085	1,293
2-#5	0.62	2.63	0.0176	99	1,408	4,640	
2-#6	0.88	2.91	0.0250	118	1,518	6,423	
2-#7	1.20	3.15	0.0341	135	1,607	8,567	
2-#8	1.58	3.36	0.0449	150	1,679	11,064	

Table C-8. 8" CMU lintel 16" deep—2 bars Type S mortar

b = 7.62 in
d = 12.62 in

$f_m = 1,350$ psi
 $F_s = 24,000$ psi

Reinf	As in ²	kd in	p	Icr in ⁴	Mrm ft-lb	Mrs ft-lb	V lb
2-#4	0.40	4.33	0.0042	797	6,908	8,943	3,533
2-#5	0.62	5.12	0.0064	1,090	7,984	13,532	
2-#6	0.88	5.81	0.0092	1,375	8,871	18,802	
2-#7	1.20	6.46	0.0125	1,663	9,657	25,122	
2-#8	1.58	7.05	0.0164	1,943	10,341	32,457	

Table C-9. 8" CMU lintel 24" deep—2 bars Type S mortar

b = 7.62 in
d = 20.62 in

$f_m = 1,350$ psi
 $F_s = 24,000$ psi

Reinf	As in ²	kd in	p	Icr in ⁴	Mrm ft-lb	Mrs ft-lb	V lb
2-#4	0.40	5.78	0.0025	2,383	15,448	14,954	5,773
2-#5	0.62	6.92	0.0039	3,341	18,107	22,708	
2-#6	0.88	7.93	0.0056	4,311	20,376	31,637	
2-#7	1.20	8.90	0.0076	5,331	22,455	42,365	
2-#8	1.58	9.81	0.0101	6,364	24,322	54,824	

Table C-10. 8" CMU lintel 32" deep—2 bars Type S mortar

b = 7.62 in
d = 28.62 in

$f_m = 1,350$ psi
 $F_s = 24,000$ psi

Reinf	As in ²	kd in	p	Icr in ⁴	Mrm ft-lb	Mrs ft-lb	V lb
2-#4	0.40	6.99	0.0018	4,888	26,239	21,033	8,013
2-#5	0.62	8.41	0.0028	6,951	31,008	32,014	
2-#6	0.88	9.69	0.0040	9,085	35,155	44,686	
2-#7	1.20	10.94	0.0055	11,383	39,028	59,938	
2-#8	1.58	12.12	0.0072	13,762	42,572	77,670	

Table C-11. 8" CMU lintel 40" deep-2 bars Type S mortar

b = 7.62 in
d = 36.62 in

f_m = 1,350 psi
F_s = 24,000 psi

Reinf	As in ²	kd in	p	I _{cr} in ⁴	M _{rm} ft-lb	M _{rs} ft-lb	V lb
2-#4	0.40	8.03	0.0014	8,339	38,942	27,155	10,253
2-#5	0.62	9.70	0.0022	11,970	46,273	41,399	
2-#6	0.88	11.22	0.0032	15,784	52,729	57,866	
2-#7	1.20	12.72	0.0043	19,952	58,835	77,714	
2-#8	1.58	14.15	0.0057	24,333	64,493	100,816	

Table C-12. 8" CMU lintel 48" deep-2 bars Type S mortar

b = 7.62 in
d = 44.62 in

f_m = 1,350 psi
F_s = 24,000 psi

Reinf	As in ²	kd in	p	I _{cr} in ⁴	M _{rm} ft-lb	M _{rs} ft-lb	V lb
2-#4	0.40	8.97	0.0012	12,754	53,336	33,305	12,493
2-#5	0.62	10.86	0.0018	18,433	63,632	50,839	
2-#6	0.88	12.60	0.0026	24,463	72,784	71,137	
2-#7	1.20	14.32	0.0035	31,125	81,517	95,633	
2-#8	1.58	15.97	0.0046	38,205	89,685	124,173	

Table C-13. 10" CMU lintel 8" deep-2 bar Type S mortar

b = 9.62 in
d = 4.62 in

f_m = 1,350 psi
F_s = 24,000 psi

Reinf	As in ²	kd in	p	I _{cr} in ⁴	M _{rm} ft-lb	M _{rs} ft-lb	V lb
2-#4	0.40	2.12	0.0090	84	1,494	3,132	1,633
2-#5	0.62	2.45	0.0140	110	1,681	4,716	
2-#6	0.88	2.73	0.0198	133	1,826	6,531	
2-#7	1.20	2.97	0.0270	154	1,946	8,710	
2-#8	1.58	3.18	0.0356	173	2,044	11,246	

Table C-14. 10" CMU lintel 16" deep-2 bar Type S mortar

b = 9.62 in
d = 12.62 in

f_m = 1,350 psi
F_s = 24,000 psi

Reinf	As in ²	kd in	p	I _{cr} in ⁴	M _{rm} ft-lb	M _{rs} ft-lb	V lb
2-#4	0.40	3.94	0.0033	844	8,032	9,046	4,461
2-#5	0.62	4.69	0.0051	1,168	9,348	13,712	
2-#6	0.88	5.35	0.0072	1,490	10,452	19,075	
2-#7	1.20	5.97	0.0099	1,822	11,447	25,512	
2-#8	1.58	6.55	0.0130	2,152	12,325	32,984	

Table C-15. 10" CMU lintel 24" deep-2 bar Type S mortar

b = 9.62 in
d = 20.62 in

f_m = 1,350 psi
F_s = 24,000 psi

Reinf	As in ²	kd in	p	I _{cr} in ⁴	M _{rm} ft-lb	M _{rs} ft-lb	V lb
2-#4	0.40	5.24	0.0020	2,494	17,843	15,098	7,288
2-#5	0.62	6.30	0.0031	3,533	21,038	22,966	
2-#6	0.88	7.25	0.0044	4,601	23,802	32,038	
2-#7	1.20	8.17	0.0060	5,744	26,370	42,953	
2-#8	1.58	9.04	0.0080	6,920	28,708	55,637	

TM 5-809-3/NAVFAC DM-2.9/AFM 88-3, Chap. 3

Table C-16. 10" CMU lintel 32" deep—2 bar Type S mortar

b = 9.62 in
d = 28.62 in

f_m = 1,350 psi
F_s = 24,000 psi

Reinf	As in ²	kd in	p	I _{cr} in ⁴	M _{rm} ft-lb	M _{rs} ft-lb	V lb
2-#4	0.40	6.31	0.0015	5,082	30,192	21,213	10,116
2-#5	0.62	7.62	0.0023	7,292	35,865	32,337	
2-#6	0.88	8.82	0.0032	9,611	40,859	45,196	
2-#7	1.20	9.99	0.0044	12,144	45,578	60,695	
2-#8	1.58	11.11	0.0057	14,804	49,948	78,732	

Table C-17. 10" CMU lintel 40" deep—2 bar Type S mortar

b = 9.62 in
d = 36.62 in

f_m = 1,350 psi
F_s = 24,000 psi

Reinf	As in ²	kd in	p	I _{cr} in ⁴	M _{rm} ft-lb	M _{rs} ft-lb	V lb
2-#4	0.40	7.24	0.0011	8,634	44,695	27,364	12,944
2-#5	0.62	8.78	0.0018	12,493	53,359	41,780	
2-#6	0.88	10.19	0.0025	16,598	61,073	58,472	
2-#7	1.20	11.58	0.0034	21,142	68,445	78,621	
2-#8	1.58	12.93	0.0045	25,980	75,352	102,100	

Table C-18. 10" CMU lintel 48" deep—2 bar Type S mortar

b = 9.62 in
d = 44.62 in

f_m = 1,350 psi
F_s = 24,000 psi

Reinf	As in ²	kd in	p	I _{cr} in ⁴	M _{rm} ft-lb	M _{rs} ft-lb	V lb
2-#4	0.40	8.08	0.0009	13,164	61,101	33,542	15,771
2-#5	0.62	9.82	0.0014	19,166	73,214	51,271	
2-#6	0.88	11.42	0.0021	25,612	84,086	71,830	
2-#7	1.20	13.01	0.0028	32,818	94,562	96,676	
2-#8	1.58	14.56	0.0037	40,567	104,458	125,659	

Table C-19. 12" CMU lintel 8" deep—2 bars Type S mortar

b = 11.62 in
d = 4.62 in

f_m = 1,350 psi
F_s = 24,000 psi

Reinf	As in ²	kd in	p	I _{cr} in ⁴	M _{rm} ft-lb	M _{rs} ft-lb	V lb
2-#4	0.40	1.98	0.0075	90	1,706	3,169	1,972
2-#5	0.62	2.30	0.0115	119	1,934	4,776	
2-#6	0.88	2.58	0.0164	145	2,112	6,619	
2-#7	1.20	2.82	0.0224	170	2,263	8,829	
2-#8	1.58	3.04	0.0294	194	2,388	11,398	

Table C-20. 12" CMU lintel 16" deep—2 bar Type S mortar

b = 11.62 in
d = 12.62 in

f_m = 1,350 psi
F_s = 24,000 psi

Reinf	As in ²	kd in	p	I _{cr} in ⁴	M _{rm} ft-lb	M _{rs} ft-lb	V lb
2-#4	0.40	3.64	0.0027	880	9,054	9,124	5,388
2-#5	0.62	4.35	0.0042	1,230	10,593	13,849	
2-#6	0.88	4.98	0.0060	1,582	11,901	19,287	
2-#7	1.20	5.59	0.0082	1,951	13,094	25,819	
2-#8	1.58	6.15	0.0108	2,322	14,160	33,403	

Table C-21. 12" CMU lintel 24" deep—2 bar Type S mortar

b = 11.62 in
d = 20.62 in

$f'_m = 1,350$ psi
 $F_s = 24,000$ psi

Reinf	As in ²	kd in	p	I _{cr} in ⁴	M _{rm} ft-lb	M _{rs} ft-lb	V lb
2-#4	0.40	4.83	0.0017	2,579	20,013	15,207	8,804
2-#5	0.62	5.82	0.0026	3,681	23,701	23,162	
2-#6	0.88	6.72	0.0037	4,828	26,925	32,346	
2-#7	1.20	7.60	0.0050	6,070	29,950	43,408	
2-#8	1.58	8.44	0.0066	7,364	32,732	56,273	

Table C-22. 12" CMU lintel 32" deep—2 bar Type S mortar

b = 11.62 in
d = 28.62 in

$f'_m = 1,350$ psi
 $F_s = 24,000$ psi

Reinf	As in ²	kd in	p	I _{cr} in ⁴	M _{rm} ft-lb	M _{rs} ft-lb	V lb
2-#4	0.40	5.81	0.0012	5,230	33,768	21,347	12,219
2-#5	0.62	7.03	0.0019	7,554	40,270	32,581	
2-#6	0.88	8.16	0.0026	10,018	46,042	45,584	
2-#7	1.20	9.27	0.0036	12,737	51,546	61,275	
2-#8	1.58	10.34	0.0048	15,624	56,668	79,553	

Table C-23. 12" CMU lintel 40" deep—2 bar Type S mortar

b = 11.62 in
d = 36.62 in

$f'_m = 1,350$ psi
 $F_s = 24,000$ psi

Reinf	As in ²	kd in	p	I _{cr} in ⁴	M _{rm} ft-lb	M _{rs} ft-lb	V lb
2-#4	0.40	6.66	0.0009	8,857	49,894	27,521	15,635
2-#5	0.62	8.09	0.0015	12,892	59,776	42,066	
2-#6	0.88	9.41	0.0021	17,223	68,643	58,931	
2-#7	1.20	10.72	0.0028	22,064	77,183	79,312	
2-#8	1.58	11.99	0.0037	27,266	85,248	103,085	

Table C-24. 12" CMU lintel 48" deep—2 bar Type S mortar

b = 11.62 in
d = 44.62 in

$f'_m = 1,350$ psi
 $F_s = 24,000$ psi

Reinf	As in ²	kd in	p	I _{cr} in ⁴	M _{rm} ft-lb	M _{rs} ft-lb	V lb
2-#4	0.40	7.42	0.0008	13,473	68,114	33,718	19,050
2-#5	0.62	9.03	0.0012	19,722	81,882	51,596	
2-#6	0.88	10.53	0.0017	26,491	94,328	72,353	
2-#7	1.20	12.03	0.0023	34,122	106,405	97,468	
2-#8	1.58	13.49	0.0030	42,400	117,898	126,794	

Table C-25. 6" CMU lintel 8" deep—1 bar Type N mortar

b = 5.62 in
d = 4.62 in

$f'_m = 1,000$ psi
 $F_s = 24,000$ psi

Reinf	As in ²	kd in	p	I _{cr} in ⁴	M _{rm} ft-lb	M _{rs} ft-lb	V lb
1-#4	0.20	2.22	0.0077	54	673	1,551	821
1-#5	0.31	2.56	0.0119	70	754	2,334	
1-#6	0.44	2.84	0.0169	83	815	3,232	
1-#7	0.60	3.09	0.0231	96	865	4,317	
1-#8	0.79	3.29	0.0304	107	905	5,566	

TM 5-809-3/NAVFAC DM-2.9/AFM 88-3, Chap. 3

Table C-26. 6" CMU lintel 16" deep—1 bar Type N mortar

b = 5.62 in
d = 12.62 in

f_m = 1,000 psi
F_s = 24,000 psi

Reinf	As in ²	kd in	p	I _{cr} in ⁴	M _{rm} ft-lb	M _{rs} ft-lb	V lb
1-#4	0.20	4.18	0.0028	550	3,659	4,491	2,243
1-#5	0.31	4.95	0.0044	756	4,241	6,801	
1-#6	0.44	5.63	0.0062	958	4,723	9,453	
1-#7	0.60	6.27	0.0085	1,165	5,156	12,656	
1-#8	0.79	6.86	0.0111	1,365	5,530	16,329	

Table C-27. 6" CMU lintel 24" deep—1 bar Type N mortar

b = 5.62 in
d = 20.62 in

f_m = 1,000 psi
F_s = 24,000 psi

Reinf	As in ²	kd in	p	I _{cr} in ⁴	M _{rm} ft-lb	M _{rs} ft-lb	V lb
1-#4	0.20	5.57	0.0017	1,637	8,162	7,505	3,665
1-#5	0.31	6.68	0.0027	2,305	9,589	11,404	
1-#6	0.44	7.67	0.0038	2,985	10,813	15,896	
1-#7	0.60	8.63	0.0052	3,710	11,947	21,329	
1-#8	0.79	9.52	0.0068	4,439	12,959	27,568	

Table C-28. 6" CMU lintel 32" deep—1 bar Type N mortar

b = 5.62 in
d = 28.62 in

f_m = 1,000 psi
F_s = 24,000 psi

Reinf	As in ²	kd in	p	I _{cr} in ⁴	M _{rm} ft-lb	M _{rs} ft-lb	V lb
1-#4	0.20	6.72	0.0012	3,350	13,843	10,552	5,086
1-#5	0.31	8.10	0.0019	4,781	16,392	16,070	
1-#6	0.44	9.35	0.0027	6,269	18,619	22,442	
1-#7	0.60	10.58	0.0037	7,891	20,720	30,163	
1-#8	0.79	11.73	0.0049	9,559	22,630	39,040	

Table C-29. 6" CMU lintel 40" deep—1 bar Type N mortar

b = 5.62 in
d = 36.62 in

f_m = 1,000 psi
F_s = 24,000 psi

Reinf	As in ²	kd in	p	I _{cr} in ⁴	M _{rm} ft-lb	M _{rs} ft-lb	V lb
1-#4	0.20	7.72	0.0010	5,706	20,524	13,618	6,508
1-#5	0.31	9.34	0.0015	8,217	24,432	20,774	
1-#6	0.44	10.82	0.0021	10,867	27,889	29,051	
1-#7	0.60	12.29	0.0029	13,795	31,190	39,095	
1-#8	0.79	13.68	0.0038	16,852	34,227	50,656	

Table C-30. 6" CMU lintel 48" deep—1 bar Type N mortar

b = 5.62 in
d = 44.62 in

f_m = 1,000 psi
F_s = 24,000 psi

Reinf	As in ²	kd in	p	I _{cr} in ⁴	M _{rm} ft-lb	M _{rs} ft-lb	V lb
1-#4	0.20	8.62	0.0008	8,717	28,089	16,699	7,930
1-#5	0.31	10.45	0.0012	12,634	33,569	25,504	
1-#6	0.44	12.14	0.0018	16,813	38,458	35,703	
1-#7	0.60	13.82	0.0024	21,479	43,167	48,096	
1-#8	0.79	15.43	0.0032	26,403	47,539	62,374	

Table C-31. 8" CMU lintel 8" deep—2 bars Type N mortar

b = 7.62 in
d = 4.62 in

f_m = 1,000 psi
F_s = 24,000 psi

Reinf	As in ²	kd in	p	I _{cr} in ⁴	M _{rm} ft-lb	M _{rs} ft-lb	V lb
2-#4	0.40	2.53	0.0114	92	1,010	3,023	1,113
2-#5	0.62	2.87	0.0176	115	1,113	4,542	
2-#6	0.88	3.14	0.0250	135	1,189	6,287	
2-#7	1.20	3.37	0.0341	152	1,248	8,389	
2-#8	1.58	3.56	0.0449	166	1,294	10,845	

Table C-32. 8" CMU lintel 16" deep—2 bar Type N mortar

b = 7.62 in
d = 12.62 in

f_m = 1,000 psi
F_s = 24,000 psi

Reinf	As in ²	kd in	p	I _{cr} in ⁴	M _{rm} ft-lb	M _{rs} ft-lb	V lb
2-#4	0.40	4.86	0.0042	990	5,658	8,800	3,041
2-#5	0.62	5.71	0.0064	1,331	6,476	13,289	
2-#6	0.88	6.44	0.0092	1,653	7,135	18,435	
2-#7	1.20	7.10	0.0125	1,969	7,705	24,608	
2-#8	1.58	7.70	0.0164	2,269	8,189	31,773	

Table C-33. 8" CMU lintel 24" deep—2 bar Type N mortar

b = 7.62 in
d = 20.62 in

f_m = 1,000 psi
F_s = 24,000 psi

Reinf	As in ²	kd in	p	I _{cr} in ⁴	M _{rm} ft-lb	M _{rs} ft-lb	V lb
2-#4	0.40	6.55	0.0025	3,010	12,774	14,750	4,969
2-#5	0.62	7.78	0.0039	4,160	14,848	22,352	
2-#6	0.88	8.87	0.0056	5,296	16,583	31,087	
2-#7	1.20	9.90	0.0076	6,464	18,142	41,571	
2-#8	1.58	10.84	0.0101	7,618	19,515	53,738	

Table C-34. 8" CMU lintel 32" deep—2 bar Type N mortar

b = 7.62 in
d = 28.62 in

f_m = 1,000 psi
F_s = 24,000 psi

Reinf	As in ²	kd in	p	I _{cr} in ⁴	M _{rm} ft-lb	M _{rs} ft-lb	V lb
2-#4	0.40	7.94	0.0018	6,232	21,815	20,780	6,896
2-#5	0.62	9.50	0.0028	8,751	25,589	31,562	
2-#6	0.88	10.90	0.0040	11,303	28,815	43,979	
2-#7	1.20	12.23	0.0055	13,995	31,776	58,901	
2-#8	1.58	13.49	0.0072	16,724	34,439	76,230	

Table C-35. 8" CMU lintel 40" deep—2 bar Type N mortar

b = 7.62 in
d = 36.62 in

f_m = 1,000 psi
F_s = 24,000 psi

Reinf	As in ²	kd in	p	I _{cr} in ⁴	M _{rm} ft-lb	M _{rs} ft-lb	V lb
2-#4	0.40	9.15	0.0014	10,699	32,495	26,857	8,824
2-#5	0.62	11.00	0.0022	15,183	38,352	40,864	
2-#6	0.88	12.67	0.0032	19,804	43,431	57,020	
2-#7	1.20	14.28	0.0043	24,764	48,160	76,461	
2-#8	1.58	15.82	0.0057	29,880	52,475	99,059	

TM 5-809-3/NAVFAC DM-2.9/AFM 88-3, Chap. 3

Table C-36. 8" CMU lintel 48" deep—2 bar Type N mortar

b = 7.62 in
d = 44.62 in

f_m = 1,000 psi
F_s = 24,000 psi

Reinf	As in ²	kd in	p	I _{cr} in ⁴	M _{rm} ft-lb	M _{rs} ft-lb	V lb
2-#4	0.40	10.23	0.0012	16,438	44,626	32,967	10,752
2-#5	0.62	12.34	0.0018	23,508	52,909	50,227	
2-#6	0.88	14.26	0.0026	30,888	60,167	70,165	
2-#7	1.20	16.13	0.0035	38,906	66,996	94,183	
2-#8	1.58	17.92	0.0046	47,281	73,293	122,124	

Table C-37. 10" CMU lintel 8" deep—2 bar Type N mortar

b = 9.62 in
d = 4.62 in

f_m = 1,000 psi
F_s = 24,000 psi

Reinf	As in ²	kd in	p	I _{cr} in ⁴	M _{rm} ft-lb	M _{rs} ft-lb	V lb
2-#4	0.40	2.34	0.0090	101	1,202	3,071	1,405
2-#5	0.62	2.69	0.0140	129	1,337	4,618	
2-#6	0.88	2.96	0.0198	153	1,438	6,392	
2-#7	1.20	3.20	0.0270	175	1,520	8,526	
2-#8	1.58	3.40	0.0356	194	1,585	11,014	

Table C-38. 10" CMU lintel 16" deep—2 bar Type N mortar

b = 9.62 in
d = 12.62 in

f_m = 1,000 psi
F_s = 24,000 psi

Reinf	As in ²	kd in	p	I _{cr} in ⁴	M _{rm} ft-lb	M _{rs} ft-lb	V lb
2-#4	0.40	4.44	0.0033	1,057	6,610	8,912	3,839
2-#5	0.62	5.25	0.0051	1,441	7,624	13,479	
2-#6	0.88	5.95	0.0072	1,811	8,455	18,721	
2-#7	1.20	6.60	0.0099	2,183	9,188	25,008	
2-#8	1.58	7.19	0.0130	2,543	9,822	32,304	

Table C-39. 10" CMU lintel 24" deep—2 bar Type N mortar

b = 9.62 in
d = 20.62 in

f_m = 1,000 psi
F_s = 24,000 psi

Reinf	As in ²	kd in	p	I _{cr} in ⁴	M _{rm} ft-lb	M _{rs} ft-lb	V lb
2-#4	0.40	5.95	0.0020	3,172	14,812	14,910	6,273
2-#5	0.62	7.11	0.0031	4,434	17,331	22,631	
2-#6	0.88	8.14	0.0044	5,704	19,471	31,517	
2-#7	1.20	9.12	0.0060	7,035	21,424	42,191	
2-#8	1.58	10.04	0.0080	8,374	23,170	54,584	

Table C-40. 10" CMU lintel 32" deep—2 bar Type N mortar

b = 9.62 in
d = 28.62 in

f_m = 1,000 psi
F_s = 24,000 psi

Reinf	As in ²	kd in	p	I _{cr} in ⁴	M _{rm} ft-lb	M _{rs} ft-lb	V lb
2-#4	0.40	7.19	0.0015	6,519	25,189	20,979	8,707
2-#5	0.62	8.64	0.0023	9,246	29,720	31,917	
2-#6	0.88	9.95	0.0032	12,054	33,645	44,533	
2-#7	1.20	11.22	0.0044	15,065	37,298	59,712	
2-#8	1.58	12.42	0.0057	18,169	40,628	77,355	

Table C-41. 10" CMU lintel 40" deep-2 bar Type N mortar

b = 9.62 in
d = 36.62 in

$f_m = 1,000$ psi
 $F_s = 24,000$ psi

Reinf	As in ²	kd in	p	Icr in ⁴	Mrm ft-lb	Mrs ft-lb	V lb
2-#4	0.40	8.27	0.0011	11,137	37,413	27,091	11,140
2-#5	0.62	9.98	0.0018	15,948	44,391	41,284	
2-#6	0.88	11.54	0.0025	20,980	50,518	57,683	
2-#7	1.20	13.06	0.0034	26,460	56,292	77,443	
2-#8	1.58	14.51	0.0045	32,195	61,626	100,433	

Table C-42. 10" CMU lintel 48" deep-2 bar Type N mortar

b = 9.62 in
d = 44.62 in

$f_m = 1,000$ psi
 $F_s = 24,000$ psi

Reinf	As in ²	kd in	p	Icr in ⁴	Mrm ft-lb	Mrs ft-lb	V lb
2-#4	0.40	9.24	0.0009	17,050	51,271	33,233	13,574
2-#5	0.62	11.18	0.0014	24,587	61,087	50,708	
2-#6	0.88	12.96	0.0021	32,560	69,786	70,928	
2-#7	1.20	14.71	0.0028	41,339	78,062	95,320	
2-#8	1.58	16.40	0.0037	50,634	85,779	123,728	

Table C-43. 12" CMU lintel 8" deep-2 bars Type N mortar

b = 11.62 in
d = 4.62 in

$f_m = 1,000$ psi
 $F_s = 24,000$ psi

Reinf	As in ²	kd in	p	Icr in ⁴	Mrm ft-lb	Mrs ft-lb	V lb
2-#4	0.40	2.20	0.0075	109	1,379	3,110	1,698
2-#5	0.62	2.54	0.0115	141	1,546	4,680	
2-#6	0.88	2.82	0.0164	170	1,673	6,479	
2-#7	1.20	3.06	0.0224	196	1,777	8,641	
2-#8	1.58	3.27	0.0294	219	1,862	11,158	

Table C-44. 12" CMU lintel 16" deep-2 bar Type N mortar

b = 11.62 in
d = 12.62 in

$f_m = 1,000$ psi
 $F_s = 24,000$ psi

Reinf	As in ²	kd in	p	Icr in ⁴	Mrm ft-lb	Mrs ft-lb	V lb
2-#4	0.40	4.12	0.0027	1,109	7,478	8,997	4,637
2-#5	0.62	4.89	0.0042	1,527	8,674	13,627	
2-#6	0.88	5.57	0.0060	1,938	9,670	18,946	
2-#7	1.20	6.20	0.0082	2,357	10,561	25,327	
2-#8	1.58	6.78	0.0108	2,770	11,341	32,733	

Table C-45. 12" CMU lintel 24" deep-2 bar Type N mortar

b = 11.62 in
d = 20.62 in

$f_m = 1,000$ psi
 $F_s = 24,000$ psi

Reinf	As in ²	kd in	p	Icr in ⁴	Mrm ft-lb	Mrs ft-lb	V lb
2-#4	0.40	5.50	0.0017	3,296	16,663	15,031	7,577
2-#5	0.62	6.59	0.0026	4,648	19,593	22,845	
2-#6	0.88	7.57	0.0037	6,026	22,111	31,850	
2-#7	1.20	8.51	0.0050	7,491	24,436	42,676	
2-#8	1.58	9.40	0.0066	8,985	26,539	55,253	

TM 5-809-3/NAVFAC DM-2.9/AFM 88-3, Chap. 3

Table C-46. 12" CMU lintel 32" deep--2 bar Type N mortar

b = 11.62 in
d = 28.62 in

$f_m = 1,000$ psi
 $F_s = 24,000$ psi

Reinf	As in ²	kd in	p	Icr in ⁴	Mrm ft-lb	Mrs ft-lb	V lb
2-#4	0.40	6.63	0.0012	6,736	28,245	21,129	10,517
2-#5	0.62	7.99	0.0019	9,628	33,472	32,186	
2-#6	0.88	9.23	0.0026	12,641	38,046	44,957	
2-#7	1.20	10.44	0.0036	15,909	42,345	60,339	
2-#8	1.58	11.59	0.0048	19,319	46,305	78,232	

Table C-47. 12" CMU lintel 40" deep--2 bar Type N mortar

b = 11.62 in
d = 36.62 in

$f_m = 1,000$ psi
 $F_s = 24,000$ psi

Reinf	As in ²	kd in	p	Icr in ⁴	Mrm ft-lb	Mrs ft-lb	V lb
2-#4	0.40	7.61	0.0009	11,469	41,862	27,267	13,466
2-#5	0.62	9.21	0.0015	16,534	49,869	41,602	
2-#6	0.88	10.68	0.0021	21,890	56,961	58,188	
2-#7	1.20	12.12	0.0028	27,785	63,705	78,196	
2-#8	1.58	13.50	0.0037	34,022	69,992	101,497	

Table C-48. 12" CMU lintel 48" deep--2 bar Type N mortar

b = 11.62 in
d = 44.62 in

$f_m = 1,000$ psi
 $F_s = 24,000$ psi

Reinf	As in ²	kd in	p	Icr in ⁴	Mrm ft-lb	Mrs ft-lb	V lb
2-#4	0.40	8.49	0.0008	17,513	57,279	33,431	16,396
2-#5	0.62	10.31	0.0012	25,410	68,495	51,069	
2-#6	0.88	11.97	0.0017	33,848	78,518	71,506	
2-#7	1.20	13.63	0.0023	43,229	88,131	96,188	
2-#8	1.58	15.23	0.0030	53,261	97,171	124,962	

BIBLIOGRAPHY

- Amrhein, J. E., *Reinforced Masonry Handbook*, 4th Ed., Masonry Institute of America, Los Angeles, CA 1983.
- A Manual of Facts on Concrete Masonry*, National Concrete Masonry Association, Herndon, VA, 1991.
- Manual of Standard Practice for Detailing Reinforced Concrete (ACI 315)*, American Concrete Institute, Detroit, MI 48219.
- Merrigan, M. W. *Efflorescence: Cause and Control*, The Masonry Society Journal, January—June, 1986.
- Noland, J. L., Atkinson, R. H., Baur, J. C., *An Investigation into Methods of Nondestructive Evaluation of Masonry Structures*, Report to the National Science Foundation, Atkinson-Noland and Associates, Boulder, CO, 1982.
- Noland, J. L., Atkinson, R. H., Kingsley, G. R., Schuller, M. P., *Nondestructive Evaluation of Masonry Structures*, Report to the National Science Foundation, January, 1991.
- Noland, J. L., Atkinson, R. H., Schuller, M. P., *A Review of the Flatjack Method for Nondestructive Evaluation*, Proceedings, Conference on Nondestructive Evaluation of Civil Structures and Materials, Boulder, CO, 1990.
- Schneider, R. R. and Dickey, W. L., *Reinforced Masonry Design*, 2nd edition, Englewood Cliffs, NJ: Prentice Hall, 1980.
- Technical Notes on Brick Construction*, Brick Institute of America, McLean, VA, 1990.
- Uniform Building Code*, International Conference of Building Officials, Whittier, CA, 1988.

The proponent agency of this publication is the office of the Chief of Engineers United States Army. Users are invited to send comments and suggested improvements on DA Form 2028 (Recommended changes to Publications and Blank Forms) to HQUSACE (CEMP-ET), WASH, DC 20314-1000.

By order of the Secretaries of the Army, the Navy, and the Air Force:

Official:

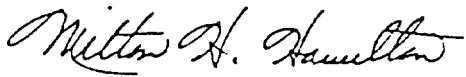

MILTON H. HAMILTON
*Administrative Assistant to the
Secretary of the Army*

GORDON R. SULLIVAN
*General, United States Army
Chief of Staff*

D. E. BOTTORFF
*Rear Admiral, United States Navy
Commander, Naval Facilities Engineering Command*

Official:

EDWARD A. PARDINI, *Colonel, USAF*
Director of Information Management

MERRILL A. McPEAK, *General USAF*
Chief of Staff

Distribution:

Army. To be distributed in accordance with DA Form 12-34-E, requirements for nonequipment technical manuals.

Air Force. F

CANCELLED