

# UNIFIED FACILITIES CRITERIA (UFC)

---

## AIRFIELD AND HELIPORT PLANNING AND DESIGN



APPROVED FOR PUBLIC RELEASE; DISTRIBUTION UNLIMITED

**UNIFIED FACILITIES CRITERIA (UFC)**

**AIRFIELD AND HELIPORT PLANNING AND DESIGN**

Any copyrighted material included in this UFC is identified at its point of use. Use of the copyrighted material apart from this UFC must have the permission of the copyright holder.

U.S. ARMY CORPS OF ENGINEERS

NAVAL FACILITIES ENGINEERING COMMAND

AIR FORCE CIVIL ENGINEER CENTER (Preparing Activity)

Record of Changes (changes are indicated by \1\ ... /1/)

<b>Change No.</b>	<b>Date</b>	<b>Location</b>

---

**This UFC supersedes UFC 3-260-01, dated 17 November 2008.**

## FOREWORD

The Unified Facilities Criteria (UFC) system is prescribed by MIL-STD 3007 and provides planning, design, construction, sustainment, restoration, and modernization criteria, and applies to the Military Departments, the Defense Agencies, and the DoD Field Activities in accordance with [USD \(AT&L\) Memorandum](#) dated 29 May 2002. UFC will be used for all DoD projects and work for other customers where appropriate. All construction outside of the United States is also governed by Status of Forces Agreements (SOFA), Host Nation Funded Construction Agreements (HNFA), and in some instances, Bilateral Infrastructure Agreements (BIA). Therefore, the acquisition team must ensure compliance with the more stringent of the UFC, the SOFA, the HNFA, and the BIA, as applicable.

UFC are living documents and will be periodically reviewed, updated, and made available to users as part of the Services' responsibility for providing technical criteria for military construction. Headquarters, U.S. Army Corps of Engineers (HQUSACE), Naval Facilities Engineering Command (NAVFAC), and Air Force Civil Engineer Center (AFCEC) are responsible for administration of the UFC system. Defense agencies should contact the preparing service for document interpretation and improvements. Technical content of UFC is the responsibility of the cognizant DoD working group. Recommended changes with supporting rationale should be sent to the respective service proponent office by the following electronic form: [Criteria Change Request \(CCR\)](#). The form is also accessible from the Internet sites listed below.

UFC are effective upon issuance and are distributed only in electronic media from the following source:

Whole Building Design Guide web site <http://dod.wbdg.org/>.

Refer to UFC 1-200-01, *DoD Building Code (General Building Requirements)*, for implementation of new issuances on projects.

### AUTHORIZED BY:



---

LARRY D. McCALLISTER, PhD, PE,  
PMP, SES  
Chief, Engineering and Construction  
U.S. Army Corps of Engineers



---

JOSEPH E. GOTT, P.E.  
Chief Engineer  
Naval Facilities Engineering Command

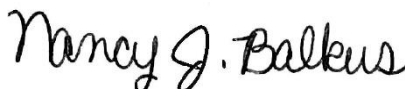

---

NANCY J. BALKUS, PE, SES, DAF  
Deputy Director of Civil Engineers  
DCS Logistics, Engineering &  
Force Protection (HAF/A4C)  
HQ United States Air Force



---

MICHAEL McANDREW  
Deputy Assistant Secretary of Defense  
(Facilities Investment and Management)  
Office of the Assistant Secretary of Defense  
(Energy, Installations, and Environment)

## UNIFIED FACILITIES CRITERIA (UFC) REVISION SUMMARY SHEET

**Document:** UFC 3-260-01, *Airfield and Heliport Planning and Design*

**Superseding:** UFC 3-260-01, dated 17 November 2008

**Description of Changes:** This update to UFC 3-260-01:

- Updates Chapter 1, *General Requirements* to clarify text per review comments. In particular, clarified applicability to existing facilities in Para 1-3.
- Updates Chapter 2, *Aviation Facilities Planning* to clarify text per comments. In particular, a) added paragraph 2-5.5 regarding stormwater management facilities near airfields; b) unified nomenclature to apply to all DoD services; c) updated Navy exceptions from criteria in Para 2-11; d) added paragraph 2-12 regarding design requirements for buried utility structures on airfields.
- Updates Chapter 3, *Runways (Fixed-Wing) and Imaginary Surfaces* to clarify text per review comments. In particular, a) clarified MV-22 applicability in paragraph 3-3.3; b) revised Table 3-1 to update for current aircraft; c) added paragraph 3-9 regarding runway end siting requirements; c) updated figures to improve resolution; d) deleted design requirements for underground structures in paragraphs 3-9.1 and 3-9.2;
- Updates Chapter 4, *Rotary-Wing Runways, Helipads, Landing Lanes, and Hoverpoints* to clarify text per review comments. In particular, a) clarified MV-22 applicability in paragraph 4-3.4; b) added paragraph 4-4.4 describing elevated helipads.
- Updates Chapter 5, *Taxiways* to clarify text per review comments. In particular, deletes paragraph 5-8.2 and Figure 5-6. This aligns Navy intersection fillet design criteria with previously published Army and Air Force criteria.
- Updates Chapter 6, *Aprons and Other Pavements* to clarify text per review comments. In particular, a) adds criteria for CH-53 helicopters including parking layout; b) adds criteria for protective barriers or shelters on parking spaces for rotary-wing aircraft in paragraph 6-7.4.3; c) adds paragraph 6-7.6 providing considerations for hot refueling operations for rotary-wing aircraft; d) adds Aircraft Wash Racks content passed from UFC 4-211-02; e) updated Compass Calibration Pad requirements.
- Updates Chapter 7 to incorporate Air Force ETL 09-6, *C-130 and C-17 Landing Zone (LZ) Dimensional, Marking and Lighting Criteria*.
- Deletes Chapter 8, *Aircraft Hangar Pavements*.
- Adds new Chapter 8, *Fixed-Wing Short Takeoff and Vertical Landing (STOVL) Facilities*. This chapter incorporates information from Air Force ETL 14-4, *Vertical Landing Zone (VLZ) And Other Airfield Pavement Design and Construction Using High Temperature Concrete* and *F-35 Lightning II STOVL Airfield Facilities and Airspace Criteria Engineering Technical Letter (ETL)*, document No: 2PSS00040, Rev 1 dated 30 July 2010. In addition, added F-35B related content and standard drawings for LHD and VL Pad facilities.
- Adds new Chapter 9, *Unmanned Aircraft Systems (UAS)*. This chapter incorporates Army ETL 1110-3-510 *Aviation Complex Planning and Design Criteria for Unmanned Aircraft Systems (UAS)*.
- Updates Glossary to include new acronyms and new terms.
- Moves Glossary to Appendix C to follow UFC template format.
- Updates Appendix A, *References*, to update hyperlinks.
- Updates Appendix B, *Section 1* to incorporate Army, Air Force and Navy revisions to clarify waiver procedures for each service.
- Updates Appendix B, *Section 2*, deleting Tables B2-1 thru B2-7 and instead providing facility space planning cross references for each service.
- Updates Appendix B, *Section 3* by deleting all text and tables, but providing cross references to DoD, Air Force and Navy source documents

- Updates Appendix B, Section 5 to delete Part 77 text and include only cross-references to the Part 77 document.
- Updates Appendix B, Section 6 to change reference for Aircraft Characteristics to Army Technical Reports.
- Updates Appendix B, Section 7.
- Updates Appendix B, Section 10, Compass Calibration Pad siting, survey and marking guidance.
- Updates Appendix B, Section 11 to remove descriptions of static grounding points and cross-referencing to UFC 3-575-01.
- Deleted Appendix B, Section 12. Replaced with content from AF ETL 07-3: *Jet Engine Thrust Standoff Requirements for Airfield Asphalt Edge Pavements*.
- Updates Appendix B, Section 13 to incorporate Army and Air Force revisions, adding new systems and deleting old systems.
- Updates Appendix B, Section 14 to incorporate some features of FAA Advisory Circular 150/5370-2F.
- Updates Appendix B, Section 15 to incorporate Air Force ETL 01-10, *Design and Construction of High Capacity Trim Pad Anchoring Systems*.
- Deletes Appendix B, Section 16.
- Updates and Renumbers Appendix B, Section 17 now be Section 16 and to delete detailed facility requirements and provide cross-reference to UFC 4-133-01.
- Updates and Renumbers Appendix B, Section 18 now be Section 17.

**Reasons for Changes:**

- Incorporate new guidance scattered throughout Army and Air Force Engineering Technical Letters.
- Incorporate guidance for STOVL facilities to be used by aircraft such as F-35B.
- Clarified MV-22 Content.
- Incorporate UAS Content.
- Response to Criteria Change Requests (CCR).
- Response to review comments made by a wide variety of UFC users among the DoD agencies, including engineers, planners, airfield managers and air traffic controllers.
- Improvement to readability of figures and addition of information via new tables and figures

**Impact:** There are negligible cost impacts; however, these benefits should be realized:

- Reduced confusion in interpreting guidance.
- Tri-service criteria for C-130 and C-17 Landing Zones.
- Consistent and clear tri-service criteria for STOVL facilities.
- Consistent and clear tri-service criteria for UAS facilities.
- Improved waiver processing guidelines

**Non-Unification Issues:** Due to differences in mission, aircraft, tactics, mishap potential and mishap rates for specific aircraft, not all criteria within this UFC are unified. The primary elements of criteria that are not unified are clear zone and accident potential zone (APZ) shapes and sizes, separation distances between runways and taxiways, and size and implementation dates for certain protected air space elements. Maintaining these differences allows the Services to avoid costs associated with non-mission-driven changes in airfield configuration and mapping, and acquisition of real property or avigation easements.

- Planning: The processes vary among the Services due to differing organizational structures and are delineated in separate Service-specific directives.
- Clear zone and APZ shapes and sizes: These areas are different for each Service and class of runway because they are based on the types of aircraft that use the runways and Service-specific accident potential.

- Distances between fixed and rotary-wing runways: The distance is greater for Air Force and Navy/Marine Corps runways due to the frequency of operations by high-performance aircraft.
- Increased width of landing lanes for Navy/Marine Corps: The width is increased to prevent rotor wash damage to landing lane shoulders and subsequent potential foreign object damage (FOD) from large rotary-wing aircraft.
- No Navy/Marine Corps requirement for paved shoulders on Class A taxiways: Same rationale as for the width of Class A taxiways above.
- Reduced site distance for Air Force taxiways: Enables the Army and Navy/Marine Corps to operate with uncontrolled taxiways.
- Increased clearance from taxiway centerlines to fixed or mobile obstacles: The Air Force routinely operates C-5 aircraft on all Air Force airfields. Use of the reduced clearances slows taxi speeds and hinders expedient operations.
- Towway width differences: The Navy/Marine Corps base towway width on three general aircraft types; the Air Force and Army base towway width on mission aircraft.
- Clearance from towway centerline to fixed or mobile obstacles: The Navy/Marine Corps require distance be based on towway type; the Air Force and Army require clearance be based on mission aircraft.
- Vertical clearance from towway pavement surface to fixed or mobile obstacles: The Navy/Marine Corps require distance be based on towway type; the Air Force and Army require clearance be based on mission aircraft.
- Differences in apron spacing for parking aircraft: The Navy/Marine Corps apron spacing requirements are developed for each aircraft in the inventory. Air Force and Army requirements are based on aircraft wingspan.
- Differences in Air Force and Army apron clearance distance: The Army requires a 38-meter (125-foot) clearance distance for all Class B aircraft aprons. This distance is sufficient to accommodate C-5 aircraft. The Air Force formerly used the same criteria but recently began basing the required distance on the most demanding aircraft that uses the apron. This is because all aprons will not accommodate C-5 aircraft.
- Differences in apron layout for rotary-wing aircraft: Formerly, Air Force and Army rotary-wing criteria were slightly different. The Air Force has adopted Army rotary-wing criteria as optional and will standardize these criteria in the next revision of AFH 32-1084, *Facility Requirements*.

## CONTENTS

<b>CHAPTER 1 GENERAL REQUIREMENTS.....</b>	<b>1</b>
<b>1-1 BACKGROUND.....</b>	<b>1</b>
<b>1-2 PURPOSE AND SCOPE.....</b>	<b>1</b>
1-2.1 Purpose.....	1
1-2.2 Scope.....	1
<b>1-3 APPLICABILITY.....</b>	<b>3</b>
1-3.1 Existing Facilities.....	3
1-3.2 Modification of Existing Facilities.....	4
1-3.3 New Construction.....	4
1-3.4 Metric Application.....	4
1-3.5 Military Activities on Civil Owned Airfields.....	4
1-3.6 USAFE Installations.....	5
1-3.7 Gravel Runways at Radar Sites.....	5
<b>1-4 GENERAL BUILDING REQUIREMENTS.....</b>	<b>5</b>
1-4.1 Explosives Safety.....	5
1-4.2 Physical Security.....	5
<b>1-5 SERVICE REQUIREMENTS.....</b>	<b>6</b>
<b>1-6 THEATER OF OPERATIONS.....</b>	<b>6</b>
<b>1-7 WAIVERS TO CRITERIA.....</b>	<b>6</b>
<b>1-8 USAF WORK ORDER COORDINATION AND AUTHORIZATION.....</b>	<b>6</b>
<b>1-9 FAA NOTICE OF PROPOSED CONSTRUCTION OR ALTERATION.....</b>	<b>7</b>
<b>1-10 CONSTRUCTION PHASING PLAN.....</b>	<b>7</b>
<b>1-11 ZONING.....</b>	<b>7</b>
<b>1-12 REFERENCES.....</b>	<b>7</b>
<b>1-13 GLOSSARY.....</b>	<b>7</b>
<b>1-14 USE OF TERMS.....</b>	<b>7</b>
<b>CHAPTER 2 AVIATION FACILITIES PLANNING.....</b>	<b>9</b>
<b>2-1 APPLICABILITY.....</b>	<b>9</b>
2-1.1 Manual Usage.....	9
2-1.2 Planning Process.....	9
2-1.3 Planning Elements.....	9
2-1.4 Guidance.....	11
2-1.5 Additional Planning Factors.....	11
2-1.6 Space Allowances.....	11
<b>2-2 JUSTIFICATION.....</b>	<b>11</b>
2-2.2 Existing Facility Assessment.....	11
2-2.3 Joint Use Facilities.....	12
<b>2-3 GENERAL PLANNING CONSIDERATIONS.....</b>	<b>12</b>
2-3.1 Goals and Objectives.....	12
2-3.2 Requirements.....	12
2-3.3 Safety.....	13
2-3.4 Design Aircraft.....	13

2-3.5	Airspace and Land Area. ....	13
<b>2-4</b>	<b>PLANNING STUDIES.....</b>	<b>15</b>
2-4.1	Master Plan.....	15
2-4.2	Land Use Studies. ....	15
2-4.3	Environmental Studies. ....	15
2-4.4	Aircraft Noise Studies. ....	16
2-4.5	Instrumented Runway Studies. ....	17
<b>2-5</b>	<b>SITING AVIATION FACILITIES. ....</b>	<b>17</b>
2-5.1	Location. ....	17
2-5.2	Site Selection.....	17
2-5.3	Airspace Approval.....	18
2-5.4	Airfield Safety Clearances.....	18
2-5.5	Storm Water Management Facilities. ....	19
2-5.6	Renewable Energy Systems.....	19
<b>2-6</b>	<b>AIRSIDE AND LANDSIDE FACILITIES.....</b>	<b>19</b>
<b>2-7</b>	<b>LANDING AND TAKEOFF SURFACES.....</b>	<b>20</b>
2-7.1	Runways and Helipads. ....	20
2-7.2	Number of Runways. ....	20
2-7.3	Number of Helipads. ....	20
2-7.4	Runway and Helipad Location. ....	20
2-7.5	Runway and Helipad Separation. ....	21
2-7.6	Runway Instrumentation. ....	21
<b>2-8</b>	<b>AIRCRAFT GROUND MOVEMENT AND PARKING AREAS. ....</b>	<b>22</b>
2-8.1	Taxiways.....	22
2-8.2	Aircraft Parking Aprons. ....	23
<b>2-9</b>	<b>AIRCRAFT MAINTENANCE AREA (OTHER THAN PAVEMENTS).....</b>	<b>24</b>
2-9.1	Aircraft Maintenance Facilities. ....	24
2-9.2	Aviation Maintenance Buildings and Hangars.....	24
2-9.3	Maintenance Aprons. ....	25
2-9.4	Apron Lighting.....	25
2-9.5	Security.....	25
<b>2-10</b>	<b>AVIATION OPERATIONS SUPPORT AREA.....</b>	<b>25</b>
2-10.1	Aviation Operations Support Facilities. ....	25
2-10.2	Location. ....	26
2-10.3	Orientation of Facilities. ....	26
2-10.4	Multiple Supporting Facilities. ....	26
2-10.5	Transient Facilities. ....	26
2-10.6	Other Support Facilities. ....	26
2-10.7	Aircraft Fuel Storage and Dispensing. ....	27
2-10.8	Service Roadways to Support Airfield Activities.....	28
<b>2-11</b>	<b>NAVY/MARINE CORPS EXCEPTIONS FROM CRITERIA NOT REQUIRING NAVFAC DESIGN WAIVERS/EXEMPTIONS FROM UFC 3- 260-01 OR NAVAIR AIRFIELD SAFETY WAIVERS. ....</b>	<b>29</b>
2-11.1	Visual Air Navigational Facilities. ....	29
2-11.2	Radar/Communications Facilities. ....	29
2-11.3	Other Facilities and Equipment.....	29



<b>2-12</b>	<b>AIRFIELD UTILITY STRUCTURES</b> .....	<b>30</b>
2-12.1	Load Bearing Pavements and Paved Shoulder Areas .....	30
2-12.2	Unpaved Shoulder Areas.....	30
2-12.3	Other Airfield Areas.....	31
<b>CHAPTER 3 RUNWAYS (FIXED-WING) AND IMAGINARY SURFACES</b> .....		<b>33</b>
<b>3-1</b>	<b>CONTENTS</b> .....	<b>33</b>
<b>3-2</b>	<b>REQUIREMENTS</b> .....	<b>33</b>
<b>3-3</b>	<b>RUNWAY CLASSIFICATION</b> .....	<b>33</b>
3-3.1	Class A Runways.....	33
3-3.2	Class B Runways.....	33
3-3.3	Special Tilt-Rotor Aircraft Considerations (V-22) .....	33
3-3.4	Landing Zones (formerly called Short Fields and Training Assault Landing Zones).....	34
<b>3-4</b>	<b>RUNWAY SYSTEMS</b> .....	<b>34</b>
3-4.1	Single Runway .....	34
3-4.2	Parallel Runways .....	35
3-4.3	Crosswind Runways .....	35
<b>3-5</b>	<b>RUNWAY ORIENTATION/WIND DATA</b> .....	<b>41</b>
<b>3-6</b>	<b>ADDITIONAL CONSIDERATIONS FOR RUNWAY ORIENTATION</b> .....	<b>41</b>
3-6.1	Obstructions.....	41
3-6.2	Restricted Airspace.....	41
3-6.3	Built-Up Areas.....	41
3-6.4	Neighboring Airports.....	41
3-6.5	Topography.....	41
3-6.6	Soil Conditions.....	41
3-6.7	Noise Analysis .....	41
<b>3-7</b>	<b>RUNWAY DESIGNATION</b> .....	<b>42</b>
<b>3-8</b>	<b>RUNWAY DIMENSIONS</b> .....	<b>42</b>
3-8.1	Runway Dimension Criteria, Except Runway Length.....	42
3-8.2	Runway Length Criteria .....	42
3-8.3	Layout .....	43
<b>3-9</b>	<b>RUNWAY END SITING REQUIREMENTS</b> .....	<b>43</b>
3-9.1	Runway Ends.....	43
3-9.2	Threshold.....	43
<b>3-10</b>	<b>SHOULDERS</b> .....	<b>66</b>
<b>3-11</b>	<b>RUNWAY OVERRUNS</b> .....	<b>67</b>
<b>3-12</b>	<b>RUNWAY CLEAR ZONES</b> .....	<b>68</b>
3-12.1	Land Use in Clear Zones .....	68
3-12.2	Clear Zone Mandatory Frangibility Zone (MFZ).....	68
3-12.3	US Navy Clear Zones .....	71
<b>3-13</b>	<b>ACCIDENT POTENTIAL ZONES (APZ)</b> .....	<b>71</b>
<b>3-14</b>	<b>AIRSPACE IMAGINARY SURFACES</b> .....	<b>72</b>
<b>3-15</b>	<b>AIRSPACE FOR AIRFIELDS WITH TWO OR MORE RUNWAYS</b> .....	<b>78</b>
<b>3-16</b>	<b>OBSTRUCTIONS TO AIR NAVIGATION</b> .....	<b>78</b>
3-16.1	Aircraft Operating Area (AOA) .....	78

3-16.2	Determining Obstructions. ....	78
3-16.3	Trees.....	79
<b>3-17</b>	<b>AIRCRAFT ARRESTING SYSTEMS. ....</b>	<b>80</b>
3-17.1	Navy and Marine Corps Requirements.....	80
3-17.2	Installation Design and Repair Considerations. ....	80
3-17.3	Joint-Use Airfields.....	81
3-17.4	Military Rights Agreements for Non-CONUS Locations.....	82

**CHAPTER 4 ROTARY-WING RUNWAYS, HELIPADS, LANDING LANES, AND HOVERPOINTS..... 83**

<b>4-1</b>	<b>CONTENTS. ....</b>	<b>83</b>
<b>4-2</b>	<b>LANDING AND TAKEOFF LAYOUT REQUIREMENTS. ....</b>	<b>83</b>
<b>4-3</b>	<b>ROTARY-WING RUNWAY.....</b>	<b>83</b>
4-3.1	Orientation and Designation. ....	83
4-3.2	Dimensions. ....	83
4-3.3	Layout.....	83
4-3.4	Special Tilt-Rotor Aircraft Considerations (V-22). ....	83
<b>4-4</b>	<b>HELIPADS.....</b>	<b>89</b>
4-4.1	Standard VFR Helipad.....	89
4-4.2	Limited Use Helipad.....	89
4-4.3	IFR Helipad.....	89
4-4.4	Elevated Helipad.....	89
4-4.5	Helipad Location.....	89
4-4.6	Dimensional Criteria.....	90
4-4.7	Layout Criteria. ....	92
<b>4-5</b>	<b>SAME DIRECTION INGRESS/EGRESS.....</b>	<b>93</b>
4-5.1	Dimensions Criteria.....	93
4-5.2	Layout Criteria. ....	93
<b>4-6</b>	<b>HOVERPOINTS.....</b>	<b>93</b>
4-6.1	General.....	93
4-6.2	Dimensions.....	93
<b>4-7</b>	<b>ELEVATED HELIPADS – ARMY AND AIR FORCE ONLY.....</b>	<b>93</b>
4-7.1	General.....	93
4-7.2	Rooftop and Other Elevated Helipads.....	93
4-7.3	Dimensions.....	94
4-7.4	Safety Net.....	96
4-7.5	Access to Elevated Helipads. ....	96
4-7.6	Fixed Objects within a Primary Surface. ....	97
4-7.7	Obstructions.....	97
4-7.8	Protection Zone. ....	97
<b>4-8</b>	<b>ROTARY-WING LANDING LANES. ....</b>	<b>97</b>
4-8.1	Requirements for a Landing Lane.....	97
4-8.2	Landing Lane Location.....	98
4-8.3	Touchdown Points. ....	98
4-8.4	Dimensions.....	98
4-8.5	Layout.....	98

4-9	<b>AIR FORCE HELICOPTER SLIDE AREAS (OR “SKID PADS”).</b>	108
4-10	<b>SHOULDERS FOR ROTARY-WING FACILITIES.</b>	108
4-11	<b>OVERRUNS FOR ROTARY-WING RUNWAYS AND LANDING LANES.</b>	109
4-12	<b>CLEAR ZONE AND ACCIDENT POTENTIAL ZONE (APZ).</b>	110
4-12.1	Clear Zone Land Use.	110
4-12.2	Accident Potential Zone (APZ).	110
4-12.3	Dimensions.	110
4-13	<b>IMAGINARY SURFACES FOR ROTARY-WING RUNWAYS, HELIPADS, LANDING LANES, AND HOVERPOINTS.</b>	110
4-14	<b>OBSTRUCTIONS AND AIRFIELD AIRSPACE CRITERIA.</b>	117
<b>CHAPTER 5 TAXIWAYS</b>		<b>119</b>
<hr/>		
5-1	<b>CONTENTS.</b>	<b>119</b>
5-2	<b>TAXIWAY REQUIREMENTS.</b>	<b>119</b>
5-3	<b>TAXIWAY SYSTEMS.</b>	<b>119</b>
5-3.1	Basic.	119
5-3.2	Parallel Taxiway.	119
5-3.3	High-Speed Taxiway Turnoff.	119
5-3.4	Additional Types of Taxiways.	119
5-3.5	Taxilanes.	119
5-3.6	USAF Taxitraks.	120
5-4	<b>TAXIWAY LAYOUT.</b>	<b>122</b>
5-4.1	Efficiency.	122
5-4.2	Direct Access.	122
5-4.3	Simple Taxiing Routes.	122
5-4.4	Delay Prevention.	122
5-4.5	Runway Exit Criteria.	122
5-4.6	Taxiway Designation.	122
5-5	<b>FIXED-WING TAXIWAY DIMENSIONS.</b>	<b>124</b>
5-5.1	Criteria.	124
5-5.2	Transverse Cross-Section.	124
5-6	<b>ROTARY-WING TAXIWAY DIMENSIONS.</b>	<b>129</b>
5-7	<b>TAXIWAYS AT DUAL USE (FIXED- AND ROTARY-WING) AIRFIELDS.</b>	<b>130</b>
5-7.1	Criteria.	130
5-7.2	Taxiway Shoulders.	130
5-8	<b>TAXIWAY INTERSECTION CRITERIA.</b>	<b>131</b>
5-8.1	Fillet-Only Dimensions.	131
5-9	<b>HIGH-SPEED RUNWAY EXITS.</b>	<b>135</b>
5-10	<b>APRON ACCESS TAXIWAYS.</b>	<b>135</b>
5-10.1	Parking Aprons.	135
5-10.2	Fighter Aircraft Aprons.	135
5-11	<b>SHOULDERS.</b>	<b>135</b>
5-11.1	Fixed-Wing Taxiways.	135
5-11.2	Rotary-Wing Taxiways.	135

<b>5-12</b>	<b>TOWWAYS.....</b>	<b>136</b>
5-12.1	Dimensions.....	136
5-12.2	Layout.....	136
5-12.3	Existing Roadway.....	136
<b>5-13</b>	<b>HANGAR ACCESS.....</b>	<b>136</b>
<b>CHAPTER 6 APRONS AND OTHER PAVEMENTS .....</b>		<b>141</b>
<b>6-1</b>	<b>CONTENTS.....</b>	<b>141</b>
<b>6-2</b>	<b>APRON REQUIREMENTS.....</b>	<b>141</b>
<b>6-3</b>	<b>TYPES OF APRONS AND OTHER PAVEMENTS.....</b>	<b>141</b>
<b>6-4</b>	<b>AIRCRAFT CHARACTERISTICS.....</b>	<b>142</b>
<b>6-5</b>	<b>PARKING APRON FOR FIXED-WING AIRCRAFT.....</b>	<b>142</b>
6-5.1	Location.....	142
6-5.2	Size.....	142
6-5.3	Army Parking Apron Layout.....	142
6-5.4	Air Force Parking Apron Layout.....	143
6-5.5	Layout for Combined Army and Air Force Parking Aprons.....	143
6-5.6	Tactical/Fighter Parking Apron Layout.....	143
6-5.7	Refueling Considerations.....	147
6-5.8	Parking Dimensions.....	147
6-5.9	Tie-downs and Mooring Points.....	147
<b>6-6</b>	<b>TAXIING CHARACTERISTICS ON APRONS FOR FIXED-WING AIRCRAFT.....</b>	<b>153</b>
6-6.1	Apron Taxilanes.....	153
6-6.2	Turning Capabilities (Aircraft Turning and Maneuvering Characteristics).....	153
6-6.3	Departure Sequencing.....	154
6-6.4	Minimum Standoff Distances from Edge Pavements.....	154
<b>6-7</b>	<b>PARKING APRON FOR ROTARY-WING AIRCRAFT.....</b>	<b>154</b>
6-7.1	Location.....	154
6-7.2	Apron Size.....	154
6-7.3	Maneuverability.....	154
6-7.4	Army Parking Apron Layout.....	155
6-7.5	Air Force Parking Apron Layout.....	156
6-7.6	Refueling Considerations.....	156
6-7.7	Parking Dimensions.....	157
<b>6-8</b>	<b>WARM-UP PADS.....</b>	<b>168</b>
6-8.1	Navy and Marine Corps.....	168
6-8.2	Location.....	168
6-8.3	Siting Considerations.....	168
6-8.4	Warm-Up Pad Size.....	169
6-8.5	Taxi-In/Taxi-Out Capabilities.....	169
6-8.6	Parking Angle.....	178
6-8.7	Turning Radius.....	178
6-8.8	Taxilanes on Warm-Up Pads.....	178
6-8.9	Tie-Downs and Grounding Points.....	178

<b>6-9</b>	<b>POWER CHECK PAD</b> .....	<b>178</b>
6-9.1	Location and Siting Considerations. ....	178
6-9.2	Unsuppressed Power Check Pad Layout. ....	178
6-9.3	Access Taxiway/Towway. ....	178
6-9.4	Grading. ....	179
6-9.5	Thrust Anchors/Mooring Points.....	179
6-9.6	Anchor Blocks.....	183
6-9.7	Power Check Pad Facilities. ....	184
6-9.8	Noise Considerations.....	184
<b>6-10</b>	<b>ARM/DEARM PADS</b> .....	<b>184</b>
6-10.1	Navy and Marine Corps Requirements.....	184
6-10.2	Location. ....	185
6-10.3	Siting Considerations.....	185
6-10.4	Arm/Dearm Pad Size.....	186
6-10.5	Taxi-In/Taxi-Out Capabilities.....	186
6-10.6	Parking Angle. ....	186
6-10.7	Turning Radius. ....	186
6-10.8	Access Road.....	186
6-10.9	Tie-downs and Grounding Points.....	186
6-10.10	Ammunition and Explosives Safety Standards.....	186
<b>6-11</b>	<b>COMPASS CALIBRATION PAD (CCP)</b> .....	<b>190</b>
6-11.1	Army. ....	190
6-11.2	Air Force. ....	190
6-11.3	Navy and Marine Corps.....	191
6-11.4	Location. ....	191
6-11.5	Siting Consideration.....	191
6-11.6	Compass Calibration Pad (CCP) Size.....	193
6-11.7	Access Taxiway/Towway.....	195
6-11.8	Grading.....	195
6-11.9	Tie-Down/Mooring Point. ....	195
6-11.10	Embedded Material.....	195
6-11.11	Control Points. ....	195
6-11.12	CCP Markings.....	195
<b>6-12</b>	<b>HAZARDOUS CARGO PADS</b> .....	<b>195</b>
6-12.1	Navy and Marine Corps Requirements.....	196
6-12.2	Siting Criteria. ....	196
6-12.3	Hazardous Cargo Pad Size.....	196
6-12.4	Access Taxiway.....	196
6-12.5	Tie-Down and Grounding Points.....	196
6-12.6	Miscellaneous Considerations.....	197
<b>6-13</b>	<b>ALERT PAD</b> .....	<b>197</b>
6-13.1	Navy and Marine Corps Requirements.....	202
6-13.2	Location.....	202
6-13.3	Siting Criteria.....	202
6-13.4	Alert Pad Size.....	202
6-13.5	Design Aircraft.....	203

6-13.6	Alert Aircraft Parking Arrangements. ....	203
6-13.7	Jet Blast Distance Requirements. ....	204
6-13.8	Taxi-In/Taxi-Out Capabilities. ....	204
6-13.9	Turning Radius. ....	204
6-13.10	Dedicated Access Taxiway. ....	206
6-13.11	Tie-Down and Grounding Points. ....	207
<b>6-14</b>	<b>AIRCRAFT WASH RACKS. ....</b>	<b>207</b>
6-14.1	Location. ....	207
6-14.2	Size and Configuration. ....	207
6-14.3	Wash Rack Size. ....	213
6-14.4	Wash Rack Facilities. ....	213
6-14.5	Wash Rack Grading. ....	214
6-14.6	Tie-Down and Grounding Points. ....	214
6-14.7	Concrete Curbs. ....	214
6-14.8	Service Points. ....	214
6-14.9	Wash Rack Utilities. ....	215
6-14.10	Aircraft Wash Equipment. ....	216
6-14.11	Safety and Health. ....	217
6-14.12	Aircraft Rinse Facilities – Birdbaths. ....	218
<b>6-15</b>	<b>HANGAR ACCESS APRONS. ....</b>	<b>220</b>
6-15.1	Dimensions. ....	220
6-15.2	Grades for Aircraft Fueling Ramps. ....	221
6-15.3	Grades for Aircraft Access into Hangars. ....	221
<b>6-16</b>	<b>TAXIING CHARACTERISTICS ON APRONS FOR ROTARY-WING AIRCRAFT. ....</b>	<b>222</b>
6-16.1	Hoverlane/Taxilane Width at Army Facilities. ....	223
6-16.2	Hoverlane/Taxilane Width at Air Force Facilities. ....	223
<b>6-17</b>	<b>FIXED-WING AND ROTARY-WING GRADING STANDARDS. ....</b>	<b>223</b>
6-17.1	Fixed-Wing Aircraft. ....	223
6-17.2	Rotary-Wing Aircraft. ....	223
6-17.3	Grades for Aircraft Fueling Ramps. ....	223
<b>6-18</b>	<b>SHOULDERS. ....</b>	<b>223</b>
<b>6-19</b>	<b>MISCELLANEOUS APRON DESIGN CONSIDERATIONS. ....</b>	<b>224</b>
6-19.1	Jet Blast Deflectors. ....	224
6-19.2	Line Vehicle Parking. ....	224
6-19.3	Utilities. ....	224
<b>6-20</b>	<b>V-22 APRON CLEARANCES. ....</b>	<b>224</b>
<b>6-21</b>	<b>US NAVY AND MARINE CORPS AIRCRAFT BLOCK DIMENSIONS. ....</b>	<b>224</b>
<b>CHAPTER 7 LANDING ZONES FOR C-130 AND C-17. ....</b>		<b>233</b>
<b>7-1</b>	<b>GENERAL INFORMATION. ....</b>	<b>233</b>
7-1.1	Differences in Service Criteria. ....	233
7-1.2	Landing Zone Marking and Lighting Standards. ....	233
7-1.3	LZ Grade Evaluation. ....	233
<b>7-2</b>	<b>DEFINITIONS. ....</b>	<b>233</b>
7-2.1	Accident Potential Zone–Landing Zone (APZ-LZ). ....	233

7-2.2	Clear Zone-LZ.....	233
7-2.3	Contingency Operations.....	233
7-2.4	Exclusion Area.....	234
7-2.5	Flashing Strobe Light (FSL).....	234
7-2.6	Graded Area.....	234
7-2.7	Imaginary Surfaces-LZ.....	234
7-2.8	Infield Area.....	234
7-2.9	Landing Zone (LZ).....	234
7-2.10	Overrun-LZ.....	235
7-2.11	Maintained Area.....	235
7-2.12	Parking Maximum on Ground (MOG).....	235
7-2.13	Paved Landing Zone (LZ).....	235
7-2.14	Primary Surface-LZ.....	235
7-2.15	Runway End.....	235
7-2.16	Semi-Prepared Landing Zone (LZ).....	236
7-2.17	Turnaround (or Hammerhead).....	236
7-2.18	Visual Landing Zone Marker Panels (VLZMP).....	236
<b>7-3</b>	<b>SITE PLANNING FOR LANDING ZONES (LZ).....</b>	<b>236</b>
7-3.1	Future Development (Land or Aircraft Technology).....	236
7-3.2	Prohibited Land Uses.....	237
7-3.3	APZs not on DoD Property.....	237
<b>7-4</b>	<b>SITING CONSIDERATIONS.....</b>	<b>237</b>
7-4.1	Training Landing Zones (LZs).....	237
7-4.2	Siting Landing Zones (LZs).....	237
7-4.3	FAA Requirements.....	237
7-4.4	Siting LZs in Built-Up Areas.....	237
7-4.5	Siting LZs Superimposed on Class A or B Runways.....	238
<b>7-5</b>	<b>GEOMETRIC CRITERIA FOR RUNWAYS AND OVERRUNS.....</b>	<b>238</b>
7-5.1	LZ Runway Lengths.....	240
7-5.2	LZ Runway Widths.....	241
7-5.3	Operating Surface Gradient Allowances.....	241
7-5.4	LZ Shoulders.....	242
7-5.5	Turnarounds.....	247
<b>7-6</b>	<b>IMAGINARY SURFACES AND LAND USE CONTROL AREAS.....</b>	<b>247</b>
<b>7-7</b>	<b>OPERATIONAL WAIVERS TO CRITERIA.....</b>	<b>258</b>
<b>7-8</b>	<b>SEPARATION DISTANCES BETWEEN PERMANENT RUNWAYS/HELIPADS AND LZ RUNWAYS.....</b>	<b>258</b>
7-8.1	Separation Distances between Permanent Runways/Helipads and LZ Runways for Simultaneous Operations.....	258
7-8.2	Separation between Permanent Class A or Class B Runways and LZ Runways for Non-Simultaneous Operations.....	258
<b>7-9</b>	<b>SURFACE TYPES.....</b>	<b>259</b>
7-9.1	Runways and Overruns.....	259
7-9.2	Turnarounds.....	260
7-9.3	Taxiways.....	260
7-9.4	Aprons.....	260

<b>7-10</b>	<b>VISUAL LANDING ZONE MARKER PANELS (VLSMP)</b> .....	<b>261</b>
7-10.1	Minimum Marking Requirements for Temporary Applications.....	261
7-10.2	Marking Requirements for Long-Term Applications.....	261
<b>7-11</b>	<b>LZ LIGHTING</b> .....	<b>265</b>
7-11.1	Minimum Lighting Requirements for Temporary Applications.....	265
7-11.2	Lighting Requirements for Permanent Applications.....	265
7-11.3	Light Locations.....	266
7-11.4	Light Circuits and Controls.....	268
7-11.5	Light Reflector Panels (Optional).....	268
7-11.6	AMP-3 (Visual Spectrum) LZ Lights Superimposed on Standard Operational Runways.....	270
7-11.7	Infrared (IR) AMP-3 and AMP-2 Lights.....	271
7-11.8	Snowplow Rings.....	272
<b>7-12</b>	<b>PAVEMENT MARKINGS</b> .....	<b>272</b>
7-12.1	Minimum Requirements.....	272
7-12.2	Markings on Semi-Prepared LZs.....	272
7-12.3	Marking Requirements for Long-Term Use on Pavements.....	273
7-12.4	LZ Markings on Class A or B Runways.....	279

## **CHAPTER 8 FIXED-WING SHORT TAKEOFF AND VERTICAL LANDING (STOVL)**

	<b>FACILITIES</b> .....	<b>283</b>
<b>8-1</b>	<b>GENERAL INFORMATION</b> .....	<b>283</b>
8-1.1	Chapter Organization.....	283
8-1.2	Facility Concepts.....	283
8-1.3	Basis of Design.....	283
8-1.4	Background.....	283
<b>8-2</b>	<b>DEFINITIONS</b> .....	<b>284</b>
8-2.1	Accident Potential Zone–STOVL (APZ-STOVL).....	284
8-2.2	Approach Clearance Surface.....	284
8-2.3	Apron-STOVL.....	284
8-2.4	Clear Zone-STOVL.....	284
8-2.5	Departure Clearance Surface (DCS)-STOVL.....	284
8-2.6	Forward Operating Base (FOB) STOVL Facility.....	285
8-2.7	Foul Line.....	285
8-2.8	High Temperature Concrete.....	285
8-2.9	Imaginary Surfaces-STOVL.....	285
8-2.10	LHD STOVL Facility.....	285
8-2.11	Primary Surface-STOVL.....	285
8-2.12	Runway Centerline-STOVL.....	285
8-2.13	Safety Zones.....	285
8-2.14	STOVL Facility.....	286
8-2.15	STOVL Pavement Surface Types.....	286
8-2.16	Vertical Landing Pad (VL Pad).....	286
<b>8-3</b>	<b>STOVL FACILITY PLANNING CONSIDERATIONS</b> .....	<b>286</b>
8-3.1	Site Conditions.....	286
8-3.2	Future Development (Land or Aircraft Technology).....	287



8-3.3	Prohibited Land Uses.....	287
8-3.4	APZs not on DoD Property. ....	287
8-3.5	SITING CONSIDERATIONS.....	287
8-3.6	FAA Requirements. ....	290
8-3.7	Airspace Approval.....	290
8-3.8	Environmental.....	290
8-3.9	Taxiway Connections.....	290
<b>8-4</b>	<b>LHD STOVL FACILITIES.....</b>	<b>292</b>
8-4.1	LHD Concept. ....	292
8-4.2	LHD Standard Drawings. ....	293
8-4.3	LHD Background. ....	293
8-4.4	LHD Geometry.....	294
8-4.5	LHD Separation Distances.....	296
8-4.6	LHD Clear Zones, Imaginary Surfaces, and APZs.....	297
8-4.7	LHD Pavement Marking.....	297
8-4.8	LHD Lighting.....	298
8-4.9	LHD Pavement Surface Types. ....	300
<b>8-5</b>	<b>F-35B VERTICAL LANDING (VL) PADS.....</b>	<b>327</b>
8-5.1	VL Pad Concept.....	327
8-5.2	VL Pad Standard Drawings.....	327
8-5.3	VL Pad Background.....	327
8-5.4	VL Pad Geometry. ....	328
8-5.5	VL Pad Separation Distances.....	329
8-5.6	VL Pad Clear Zones, Imaginary Surfaces, and APZs.....	330
8-5.7	VL Pad Pavement Marking.....	330
8-5.8	VL Pad Lighting.....	331
8-5.9	VL Pad Pavement Surface Types.....	331
<b>8-6</b>	<b>FORWARD OPERATING BASE (FOB) STOVL FACILITY.....</b>	<b>345</b>
8-6.1	FOB Concept.....	345
8-6.2	FOB Standard Drawings.....	345
8-6.3	FOB Background.....	345
8-6.4	FOB Geometry.....	346
8-6.5	FOB Separation Distances.....	347
8-6.6	FOB Clear Zones, Imaginary Surfaces, and APZs.....	347
8-6.7	Accident Potential Zones.....	348
8-6.8	FOB Pavement Markings.....	348
8-6.9	FOB Lighting.....	349
8-6.10	FOB Pavement Surface Types.....	349
<b>8-7</b>	<b>V-22 TILT-ROTOR OUTLYING LANDING FIELD (OLF) FACILITY FOR TRAINING.....</b>	<b>365</b>
8-7.1	OLF Concept.....	365
8-7.2	OLF Standard Drawings.....	365
8-7.3	OLF Background.....	365
8-7.4	OLF Geometry.....	365
8-7.5	OLF Separation Distances.....	366
8-7.6	OLF Clear Zones, Imaginary Surfaces, and APZs.....	367

8-7.7	OLF Pavement Markings. ....	367
8-7.8	OLF Lighting. ....	367
8-7.9	OLF Pavement Surface Types.....	367

**CHAPTER 9 UNMANNED AIRCRAFT SYSTEMS (UAS)..... 379**

<b>9-1</b>	<b>CONTENTS. ....</b>	<b>379</b>
<b>9-2</b>	<b>REQUIREMENTS. LAND USE AND AIRSPACE APPROVAL.....</b>	<b>379</b>
<b>9-3</b>	<b>RUNWAY.....</b>	<b>379</b>
<b>9-4</b>	<b>AIRCRAFT COVERED IN THIS CHAPTER.....</b>	<b>379</b>
<b>9-5</b>	<b>AIRCRAFT CHARACTERISTICS. ....</b>	<b>379</b>
<b>9-6</b>	<b>AIRFIELD DIMENSIONAL CRITERIA. ....</b>	<b>379</b>
9-6.1	Airfields/Heliports Used by Both Manned and Unmanned Aircraft. ....	380
9-6.2	Permissible Deviations from Design Criteria.....	380
9-6.3	UAS Runway Co-located with an Active Army Airfield, Army Heliport, Air Force, Navy or Marine Corps Runway. ....	380
9-6.4	UAS-only Facilities.....	381
9-6.5	Runway Overruns. ....	390
9-6.6	Runway Clear Zones. ....	390
<b>9-7</b>	<b>TAXIWAYS.....</b>	<b>395</b>
9-7.1	Basic. ....	395
9-7.2	Parallel Taxiway. ....	396
9-7.3	Taxiway Intersection Criteria.....	396
9-7.4	Hangar Access Taxiways.....	396
9-7.5	Shoulders.....	396
9-7.6	Towways.....	398
<b>9-8</b>	<b>APRONS AND OTHER PAVEMENTS.....</b>	<b>400</b>
9-8.1	Apron Requirements.....	400
9-8.2	Types of Aprons and Other Pavements.....	400
9-8.3	RQ-4A/B Global Hawk Parking Apron. ....	400
9-8.4	Hangar Access Apron.....	401
<b>9-9</b>	<b>MOORING AND GROUNDING POINTS.....</b>	<b>402</b>
9-9.1	Layout.....	402
<b>9-10</b>	<b>LIGHTING.....</b>	<b>407</b>
<b>9-11</b>	<b>MARKING.....</b>	<b>407</b>

**APPENDIX A REFERENCES..... 409**

**APPENDIX B SECTION 1 WAIVER PROCESSING PROCEDURES..... 419**

B1-1	ARMY. ....	419
B1-1.1	Waivers to Criteria and Standards. ....	419
B1-1.2	Responsibilities.....	421
B1-1.3	Waiver Process Procedures. ....	422
B1-2	AIR FORCE. ....	423
B1-2.1	Waivers to Criteria. ....	423
B1-2.2	Contents of Waiver Request Package. ....	426

B1-2.3	Processing Waiver Requests.....	427
B1-2.4	Review of Waivers.....	427
B1-2.5	Responsibilities.....	428
B1-3	NAVY AND MARINE CORPS.....	429
B1-3.1	Applicability.....	429
B1-3.2	Navy/Marine Corps Design and Airfield Safety Waiver Processes.....	430
B1-3.3	Exceptions from Waivers.....	431

**APPENDIX B SECTION 2 LAND USE AND FACILITY SPACE -- ALLOWANCES . 433**

B2-1	APPLICABILITY.....	433
B2-1.1	Army.....	433
B2-1.2	Air Force.....	433
B2-1.3	Navy and Marine Corps.....	433

**APPENDIX B SECTION 3 DOD AIR INSTALLATIONS COMPATIBLE USE ZONES ..... 435**

B3-1	REFERENCES.....	435
B3-1.1	DoD.....	435
B3-1.2	Air Force.....	435
B3-1.3	Navy and Marine Corps.....	435

**APPENDIX B SECTION 4 WIND COVERAGE STUDIES ..... 437**

B4-1	APPLICABILITY.....	437
B4-1.1	Army.....	437
B4-1.2	Air Force.....	437
B4-1.3	Navy and Marine Corps.....	437
B4-2	OBJECTIVE.....	437
B4-3	GENERAL.....	437
B4-3.1	Basic Conditions.....	437
B4-3.2	Meteorological Conditions.....	438
B4-4	WIND VELOCITY AND DIRECTION.....	438
B4-4.1	Composite Windrose.....	438
B4-4.2	Terrain.....	439
B4-4.3	Additional Weather Data.....	439
B4-4.4	Wind Distribution.....	439
B4-5	USE OF WINDROSE DIAGRAMS.....	439
B4-5.1	Drawing the Windrose.....	439
B4-5.2	Special Conditions.....	439
B4-5.3	Desired Runway or Helipad Orientation.....	444
B4-6	WIND COVERAGE REQUIREMENTS FOR RUNWAYS.....	446
B4-6.1	Primary Runways or Helipads.....	446
B4-6.2	Secondary Runways.....	446
B4-6.3	Maximum Allowable Crosswind Components (Navy Only).....	446
B4-6.4	Allowable Variations of Wind Direction.....	446

**APPENDIX B SECTION 5 FEDERAL AVIATION REGULATION PART 77, OBJECTS AFFECTING NAVIGABLE AIRSPACE..... 449**

**APPENDIX B SECTION 6 AIRCRAFT CHARACTERISTICS FOR AIRFIELD-HELIPORT DESIGN AND EVALUATION..... 451**

**B6-1 GENERAL..... 451**

**APPENDIX B SECTION 7 JET BLAST EFFECTS ..... 453**

B7-1	CONTENTS.....	453
B7-2	CONSIDERATIONS.....	453
B7-2.1	Blast Temperatures.....	453
B7-2.2	Blast Velocities.....	453
B7-2.3	Minimum Clearances.....	453
B7-2.4	Engine Blast Relationship.....	453
B7-3	PROTECTION FROM JET BLAST EFFECTS.....	453
B7-3.1	Blast Deflectors.....	454
B7-3.2	Unprotected Areas.....	454
B7-3.3	Minimum Distances for Run-Up.....	454
B7-4	NOISE CONSIDERATIONS.....	454
B7-5	JET BLAST REQUIREMENTS.....	454
B7-5.1	Parked Aircraft.....	454
B7-5.2	Taxiing Aircraft.....	454

**APPENDIX B SECTION 8 JET BLAST DEFLECTOR ..... 455**

B8-1	OVERVIEW.....	455
B8-1.1	Location.....	455
B8-1.2	Size and Configuration.....	455
B8-1.3	Paved Shoulders.....	455

**APPENDIX B SECTION 9 EXPLOSIVES ON OR NEAR AIRFIELDS ..... 457**

B9-1	CONTENTS.....	457
B9-2	SEPARATION DISTANCE REQUIREMENTS.....	457
B9-3	PROHIBITED ZONES.....	457
B9-4	HAZARDS OF ELECTROMAGNETIC RADIATION TO EID.....	457
B9-5	LIGHTNING PROTECTION.....	457
B9-6	GROUNDING OF AIRCRAFT.....	457
B9-7	HOT REFUELING.....	458

**APPENDIX B SECTION 10 COMPASS CALIBRATION PAD MAGNETIC SURVEY 459**

B10-1	CONTENTS.....	459
B10-2	AIR FORCE REQUIREMENTS.....	459
B10-3	CCP SURVEY AUTHORITIES AND RESOURCES.....	459
B10-4	CCP SURVEY ACCURACY REQUIREMENTS.....	460
B10-5	PRELIMINARY SURVEY REQUIREMENTS.....	460

B10-5.1	Proton Magnetometer Method. ....	461
B10-5.2	Distant Object Method. ....	461
B10-5.3	Reciprocal Observation Method.....	461
B10-6	MAGNETIC SURVEY REQUIREMENTS. ....	461
B10-7	MAGNETIC SURVEY PROCEDURES.....	461
B10-7.1	Magnetic Field Survey. ....	461
B10-7.2	Magnetic Direction Survey.....	464
B10-8	CCP CONTROL POINTS. ....	464
B10-8.1	New CCP Control Points.....	464
B10-8.2	Type I CCP Control Points.....	465
B10-8.3	Type II CCP Control Points.....	465
B10-8.4	Existing CCPs. ....	465
B10-9	CCP Markings.....	467
B10-9.1	Magnetic Compass Calibration Pad Type I Markings.....	467
B10-9.2	Magnetic Compass Calibration Pad Type II Markings.....	468
B10-9.3	Calibration Survey Data Markings.....	468
B10-10	SITING CONSIDERATIONS.....	468
B10-10.1	Separation Distances.....	468
B10-10.2	Checking Site.....	469

**APPENDIX B SECTION 11 TIEDOWNS, MOORING, AND GROUNDING POINTS.. 471**

B11-1	TYPES OF EQUIPMENT.....	471
B11-1.1	Mooring and Grounding Point.....	471
B11-1.2	Mooring Point.....	471
B11-1.3	Static Grounding Point.....	471
B11-1.4	Static Ground.....	471
B11-1.5	Tiedown Mooring Eye.....	471
B11-2	MOORING POINTS FOR ARMY FIXED- AND ROTARY-WING AIRCRAFT.....	471
B11-2.1	Type.....	471
B11-2.2	Design Load.....	473
B11-2.3	Layout.....	473
B11-2.4	Installation.....	474
B11-3	EXISTING MOORING POINTS FOR ARMY.....	482
B11-3.1	Evaluation of Existing Mooring Points for Structural Adequacy.....	482
B11-3.2	Evaluation of Existing Mooring Points for Resistance.....	483
B11-4	STATIC GROUNDING POINTS FOR ARMY AND AIR FORCE FIXED- AND ROTARY-WING FACILITIES.....	483
B11-5	AIR FORCE TIEDOWNS.....	484
B11-5.1	General.....	484
B11-5.2	Layout.....	484
B11-5.3	Installation.....	486
B11-6	TIEDOWN MOORING EYES FOR NAVY AND MARINE CORPS.....	487

**APPENDIX B SECTION 12 JET ENGINE THRUST STANDOFF REQUIREMENTS  
FOR AIRFIELD ASPHALT EDGE PAVEMENTS ..... 491**

B12-1	PURPOSE.....	491
B12-2	APPLICATION.....	491
B12-2.1	Authority.....	491
B12-2.2	Intended Users.....	491
B12-2.3	Referenced Publications.....	491
B12-2.4	Background.....	492
B12-2.5	Analysis.....	492
B12-2.6	Standoff Distances.....	493
B12-2.7	Run-Up Pad Design.....	495
B12-2.8	Run-Up Pad Markings.....	496

**APPENDIX B SECTION 13 DEVIATIONS FROM CRITERIA FOR AIR FORCE AND  
ARMY AIRFIELD SUPPORT FACILITIES ..... 497**

B13-1	WAIVERABLE AIRFIELD SUPPORT FACILITIES.....	497
B13-1.1	Contents.....	497
B13-1.2	Navy and Marine Corps Requirements.....	497
B13-1.3	Fixed Base Airport Surveillance Radar (ASR) or Fixed Base Digital Airport Surveillance Radar (DASR).....	497
B13-1.4	Airport Rotating Beacon.....	497
B13-1.5	Nondirectional Radio Beacon Facilities.....	497
B13-1.6	Air Traffic Control Tower (ATCT).....	498
B13-2	PERMISSIBLE DEVIATIONS FROM DESIGN CRITERIA.....	498
B13-2.1	Contents.....	498
B13-2.2	Frangibility Requirements.....	499
B13-2.3	Visual Air Navigational Facilities.....	502
B13-2.4	Radar Facilities.....	502
B13-2.5	Emergency Generators, Maintenance and Personnel Facilities (Non- Frangible).....	504
B13-2.6	Remote Microwave Link (Non-Frangible).....	504
B13-2.7	PAR Reflectors (Frangible and Non-Frangible).....	504
B13-2.8	Airborne Radar Approach Reflectors (Non-Frangible).....	505
B13-2.9	Instrument Landing System (ILS).....	505
B13-2.10	Microwave Landing System (MLS) and Mobile Microwave Landing System (MMLS) (Non-Frangible).....	507
B13-2.11	Mobile Navigational Aids and Communication Facilities (Non- Frangible).....	507
B13-2.12	Mobile Air Traffic Control Towers (MATCT)/Mobile Tower System (MOTS) (Non-Frangible).....	507
B13-2.13	Terminal Very High Frequency Omnirange (TVOR) Facility and Very High Frequency Omnirange (VOR) Facility (Non-Frangible).....	508
B13-2.14	Tactical Air Navigation (TACAN) Facility and Very High Frequency Omnidirectional Radio Range (VORTAC) Facility (Non-Frangible).....	508
B13-2.15	Non-Directional Beacon (NDB) (Non-Frangible).....	508

B13-2.16	Tactical Automated Landing System (TALS) (Non-Frangible).....	508
B13-2.17	Runway Supervisory Unit (RSU) (Non-Frangible) (USAF Only). ....	509
B13-2.18	Fixed Base Weather Observing Systems (Non-Frangible). ....	509
B13-2.19	Wind Direction Indicators (Frangible and Non-Frangible). ....	510
B13-2.20	UAS Support Equipment (Frangible and Non-Frangible).....	510
B13-2.21	General Information for Operational and Maintenance Support Facilities.....	511

**APPENDIX B SECTION 14 CONSTRUCTION PHASING PLAN AND OPERATIONAL SAFETY ON AIRFIELDS DURING CONSTRUCTION..... 521**

B14-1	CONTENTS. ....	521
B14-2	NAVY AND MARINE CORPS REQUIREMENTS. ....	521
B14-3	INFORMATION TO BE SHOWN ON THE CONSTRUCTION PHASING PLAN. ....	521
B14-3.1	Phasing.....	521
B14-3.2	Aircraft Operational Areas.....	521
B14-3.3	Additional Requirements.....	521
B14-3.4	Temporary Displaced Thresholds.....	521
B14-3.5	Access. ....	522
B14-3.6	Temporary Marking and Lighting. ....	522
B14-3.7	Safety Requirements and Procedures. ....	522
B14-3.8	FOD Checkpoints. ....	522
B14-4	OTHER ITEMS TO BE SHOWN IN THE CONTRACT DRAWINGS.....	522
B14-4.1	Storage. ....	522
B14-4.2	Parking.....	522
B14-4.3	Buildings. ....	522
B14-4.4	Designated Waste and Disposal Areas.....	522
B14-5	MAXIMUM EQUIPMENT HEIGHT.....	522
B14-6	OPERATIONAL SAFETY ON THE AIRFIELD DURING CONSTRUCTION. ....	523
B14-6.1	General Requirements.....	523
B14-6.2	Formal Notification of Construction Activities.....	524
B14-6.3	Safety Considerations.....	524
B14-6.4	Examples of Hazardous and Marginal Conditions. ....	526
B14-6.5	Vehicles on the Airfield. ....	527
B14-6.6	Inspection. ....	528
B14-6.7	Special Safety Requirements during Construction.....	528
B14-6.8	Construction Vehicle Traffic.....	530
B14-6.9	Limitation on Construction. ....	530
B14-6.10	Marking and Lighting Closed or Hazardous Areas on Airfields.....	530
B14-6.11	Temporary Runway Threshold Displacement. ....	530

**APPENDIX B SECTION 15 ARMY AND AIR FORCE AIRCRAFT TRIM PAD AND THRUST ANCHOR FOR 267 KILONEWTONS (60,000 POUNDS) AND 445 KILONEWTONS (100,000 POUNDS) THRUST ..... 533**

B15-1	PURPOSE.....	533
B15-2	BACKGROUND.....	533
B15-3	ANALYSIS AND VISUAL INSPECTIONS.....	533
B15-4	CONSTRUCTION.....	533
B15-4.1	Materials and Manufacturing.....	533
B15-4.2	Placement of Rebar.....	533
B15-4.3	Pouring and Finishing Concrete.....	534

**APPENDIX B SECTION 16 AIR TRAFFIC CONTROL TOWER SITING CRITERIA.. 543**

B16-1	GENERAL INFORMATION.....	543
B16-2	SITING CRITERIA.....	543
B16-2.1	Unobstructed View.....	543
B16-2.2	Site Area Requirements.....	543
B16-2.3	Quantity Distance Criteria.....	543
B16-2.4	Obstruction Clearance.....	544
B16-2.5	Siting Effects on NAVAIDS.....	544
B16-2.6	Siting for Proper Depth Perception.....	544
B16-2.7	Compliance with Airfield Standards.....	545
B16-2.8	Orientation of the Control Cab.....	545
B16-2.9	Extraneous Lighting.....	545
B16-2.10	Weather Phenomena.....	545
B16-2.11	Exhaust Fumes and other Visibility Impairments.....	545
B16-2.12	Avoid Sources of Extraneous Noise.....	545
B16-2.13	Personnel Access Considerations.....	545
B16-2.14	Compliance with the Comprehensive Plan.....	545
B16-2.15	Consider the Effects on Meteorological and Communications Facilities.....	546
B16-3	MINIMUM REQUIRED FLOOR LEVELS.....	549
B16-4	SITING PROCEDURES.....	549
B16-4.1	Office Study by Siting Engineers.....	549
B16-4.2	Field Study by Siting Engineers.....	549
B16-4.3	TERPS Analysis.....	550
B16-5	SITE RECOMMENDATIONS.....	550
B17-6	SOI DISTRIBUTION.....	550
B17-7	SAMPLE SOI.....	550
B16-7.1	Site Numbers.....	551
B16-7.2	Allied Support Requirements.....	551
B16-7.3	Utilities.....	551

**APPENDIX B SECTION 17 GUIDELINES FOR ESTABLISHING BUILDING RESTRICTION LINE AT AIR FORCE BASES..... 553**

B17-1	OVERVIEW.....	553
B17-1.1	General Information.....	553
B17-1.2	Purpose.....	553
B17-2	ESTABLISHING THE BRL AT A BASE.....	553



B17-3	STATUS OF EXISTING AND FUTURE FACILITIES AND OBSTRUCTIONS WITHIN THE AREA.....	554
B17-4	FUTURE DEVELOPMENT OF AREA WITHIN BRL CONTROL LINES.....	554
B17-4.1	Future Construction.....	554
B17-4.2	Existing Facilities.....	555
B17-5	FUTURE MODIFICATION TO BRL.....	555
<b>APPENDIX C GLOSSARY .....</b>		<b>559</b>

CANCELLED

## FIGURES

Figure 2-1. Aviation Facilities Planning Process .....	10
Figure 3-1. Runway Transverse Sections and Primary Surface .....	45
Figure 3-2. Clear Zone Transverse Section Detail .....	46
Figure 3-3. Runway and Overrun Longitudinal Profile .....	47
Figure 3-4. Army Clear Zone and Accident Potential Zone Guidelines .....	48
Figure 3-5. Air Force Clear Zone and APZ Guidelines .....	49
Figure 3-6. Navy and Marine Corps Clear Zone and APZ Guidelines .....	50
Figure 3-7. Class A VFR Runway Primary Surface End Details .....	51
Figure 3-8. Class A VFR Runway Isometric Airspace Imaginary Surfaces .....	52
Figure 3-9. Class A VFR Runway Plan and Profile Airspace Imaginary Surfaces .....	53
Figure 3-10. Class A IFR Runway Primary Surface End Details .....	54
Figure 3-11. Class A IFR Runway Airspace Imaginary Surfaces .....	55
Figure 3-12. Class A IFR Runway Plan and Profile Airspace Imaginary Surfaces .....	56
Figure 3-13. Class B Army and Air Force Runway End and Clear Zone Details .....	57
Figure 3-14. Class B Army Runway Airspace Imaginary Surfaces .....	58
Figure 3-15. Class B Army and Air Force Runway Airspace Plan and Profile Runway Imaginary Surfaces .....	59
Figure 3-16. Class B Navy Runway Primary Surface End Details .....	60
Figure 3-17. Class B Air Force and Navy Runway Airspace Imaginary Surfaces .....	61
Figure 3-18. Class B Navy Runway Airspace Plan and Profile Runway Imaginary Surfaces .....	62
Figure 3-19. VFR and IFR Crosswind Runways Isometric Airspace Imaginary Surfaces .....	63
Figure 3-20. Plan, Single Runway, Navy Class A, and Basic Training Outlying Field ...	64
Figure 3-21. Plan, Single Runway, and Navy Class B .....	65
Figure 3-22. Typical Layout, Navy Dual Class B Runways .....	66
Figure 4-1. Helicopter VFR Runway .....	86
Figure 4-2. Helicopter IFR Runway .....	87
Figure 4-3. IFR Airspace Imaginary Surfaces: IFR Helicopter Runway and Helipad .....	88
Figure 4-4. Elevated Helipad Layout Criteria for UH-60 or Smaller Rotor Diameter Helicopters (8H:1V) .....	95
Figure 4-5. Elevated Helipad Layout Criteria for CH-47 and Larger Helicopters (8H:1V) .....	95
Figure 4-6. Elevated Hospital Helipad Layout Criteria for UH-60 or Smaller Rotor Diameter Helicopters (16.4H:1V) .....	96
Figure 4-7. Elevated Hospital Helipad Layout Criteria for CH-47 and Larger Helicopters (16.4H:1V) .....	96
Figure 4-8. Standard VFR Helipad for Army and Air Force .....	99
Figure 4-9 Standard VFR Helipad for Navy and Marine Corps and Limited Use VFR Helipad for Army and Air Force .....	100
Figure 4-10. Standard IFR Helipad .....	101
Figure 4-11. Army, Air Force, Navy, and Marine Corps VFR Helipad with Same Direction Ingress/Egress .....	102

Figure 4-12. Army and Air Force VFR Limited Use Helipad with Same Direction Ingress/Egress .....	103
Figure 4-13. Army and Air Force IFR Helipad with Same Direction Ingress/Egress....	104
Figure 4-14. Helicopter Hoverpoint.....	105
Figure 4-15. Rotary-Wing Landing Lane .....	107
Figure 5-1. Common Taxiway Designations.....	121
Figure 5-2. Spacing Requirements: Normal Taxiway Exits .....	123
Figure 5-3. Taxiway and Primary Surface Transverse Sections.....	128
Figure 5-4. Runway/Taxiway Intersection Fillets .....	133
Figure 5-5. Taxiway/Taxiway Intersection Fillets .....	134
Figure 5-6. Towway Criteria .....	139
Figure 6-1. Apron Nomenclature and Criteria.....	144
Figure 6-2. Army and Air Force Parking Plan.....	145
Figure 6-3. Apron with Diagonal Parking.....	146
Figure 6-4. Truck Refueling Safety Zone Example.....	148
Figure 6-5. Type 1 Parking for All Rotary-Wing Aircraft Except CH-47 .....	158
Figure 6-6. Type 1 Parking for CH-47 .....	159
Figure 6-7. Army Type 1 Parking for CH-53 .....	160
Figure 6-8. Army Type 1 Parking for CH-53 with Protective Barriers or Shelters .....	161
Figure 6-9. Type 2 Parking for Skid Rotary-Wing Aircraft.....	162
Figure 6-10. Type 2 Parking for Wheeled Rotary-Wing Aircraft .....	163
Figure 6-11. Refueling Safety Zone Example for Rotary-Wing Aircraft for Normal (Cold) Refueling Operations .....	164
Figure 6-12. Refueling Safety Zone Example for Rotary-Wing Aircraft for Hot Refueling.....	165
Figure 6-13. Warm-Up Pad at End of Parallel Taxiway .....	170
Figure 6-14. Warm-Up Pad Next to Parallel Taxiway .....	171
Figure 6-15. Warm-Up Pad Located in Clear Zone .....	172
Figure 6-16. Warm-Up Pad Located in Approach-Departure Clearance Surface .....	173
Figure 6-17. Warm-Up Pad/Localizer Critical Area .....	174
Figure 6-18. Warm-Up Pad/Glide Slope Critical Area .....	175
Figure 6-19. Warm-Up Pad/CAT II ILS Critical Area .....	176
Figure 6-20. Warm-Up Pad Taxiing and Wingtip Clearance Requirements .....	177
Figure 6-21. Geometry for Rectangular Power Check Pad .....	180
Figure 6-22. Geometry for Square Power Check Pad .....	181
Figure 6-23. Geometry for Circular Power Check Pad .....	182
Figure 6-24. Power Check Pad Grading.....	183
Figure 6-25. Arm-Dearm Pad for F-15 Fighter .....	187
Figure 6-26. Arm-Dearm Pad for F-16 Fighter .....	188
Figure 6-27. Arm-Dearm Pad for F-22 Fighter .....	189
Figure 6-28. Arm-Dearm Pad for F-35 Fighter (JSF).....	190
Figure 6-29. Compass Calibration Pad .....	194
Figure 6-30. Hazardous Cargo Pad Other than APOE/Ds .....	198
Figure 6-31. Typical Hazardous Cargo Pad for APOE/Ds.....	199
Figure 6-32. Typical Alert Apron for Bombers and Tanker Aircraft.....	200
Figure 6-33. Typical Alert Pad for Fighter Aircraft .....	201

Figure 6-34. Alert Apron Taxi-In/Taxi-Out Parking .....	205
Figure 6-35. Alert Apron Back-In Parking.....	206
Figure 6-36. Wash Rack Selection Chart .....	207
Figure 6-37. Wash Rack Type “F” .....	209
Figure 6-38. Wash Rack Type “L” .....	210
Figure 6-39. Utilities and In-Pavement Structures.....	211
Figure 6-40. Helicopter Wash Rack (Single Helicopter) .....	212
Figure 6-41. Aircraft Rinse Facility (Birdbath).....	220
Figure 6-42. V-22 Apron Clearance Requirements .....	225
Figure 6-43. Navy/Marine Corps, 90-Degree Aircraft Parking Configuration.....	226
Figure 6-44. Navy/Marine Corps, 45-Degree Aircraft Parking Configuration.....	230
Figure 7-1. LZ Primary Surface End Details.....	252
Figure 7-2. LZ Details.....	253
Figure 7-3. LZ with Contiguous Aprons and Turnarounds.....	254
Figure 7-4. LZ Apron Layout Details.....	255
Figure 7-5. LZ Runway Imaginary Surfaces .....	256
Figure 7-6. LZ Runway, Taxiway, and Apron Sections.....	257
Figure 7-7. Example VLZMP on Concrete Base Detail .....	263
Figure 7-8. Airfield Marking Patterns (AMP).....	264
Figure 7-9. Lighting Plans .....	269
Figure 7-9. Lighting Plans (continued).....	270
Figure 7-10. Stake Chasers for Marking Edges of Semi-Prepared LZs, Taxiways and Turnarounds .....	273
Figure 7-11. LZ Painted Marking Layout .....	275
Figure 7-12. Typical Turnaround Marking and Lighting Plan.....	276
Figure 7-13. Typical Bi-Directional Runway/Taxiway Marking and Lighting Layout ....	277
Figure 7-14. Light and Marker Panel Layout Detail on a Landing Zone with Combination AMP-1, AMP-3 (Visual Spectrum) and Infrared AMP-3 .....	278
Figure 7-15. AMP-3 Lighting and Marking Scheme for LZ Superimposed on Class A or B Runway .....	280
Figure 7-16. AMP-3 Visible and Infrared Lighting and Marking Layout Detail for LZ Superimposed on Class A Runway .....	281
Figure 7-17. AMP-3 Visible and Infrared Lighting and Marking Layout Detail for LZ Superimposed on Class B Runway .....	282
Figure 8-1. LHD STOVL Facility Outline.....	309
Figure 8-2. LHD STOVL Facility Safety Zones.....	309
Figure 8-3. LHD STOVL Facility Longitudinal Gradient.....	310
Figure 8-4. LHD STOVL Facility Transverse Section .....	310
Figure 8-5. LHD STOVL Facility Departure Clearance Surface and Clear Zone .....	311
Figure 8-6. LHD STOVL Facility Departure Clear and Accident Potential Zones .....	311
Figure 8-7. LHD STOVL Facility Departure Surface Isometric View .....	312
Figure 8-8. LHD STOVL Facility Departure Surface and Transverse Imaginary Surfaces.....	313
Figure 8-9. LHD STOVL Facility Approach Path Imaginary Surfaces .....	314
Figure 8-10. LHD STOVL Facility Approach Surface Isometric View .....	315
Figure 8-11. LHD STOVL Facility Approach Path Clear Zones and APZs .....	316

Figure 8-12. LHD STOVL Facility Approach Path Clear Zones .....	316
Figure 8-13. LHD STOVL Facility Approach End Details .....	317
Figure 8-14. LHD Overall Marking.....	318
Figure 8-15. LHD Marking Details .....	319
Figure 8-16. LHD Overall Lighting .....	320
Figure 8-17. LHD Aft Deck Lighting.....	321
Figure 8-18. LHD Forward Deck Lighting .....	322
Figure 8-19. LHD Landing Spot Lighting Detail .....	323
Figure 8-20. LHD LSO Tower Elevation Detail .....	324
Figure 8-21. LHD Pavement Surface Types.....	325
Figure 8-22. LHD Pavement Surface Types Detail .....	326
Figure 8-23. Vertical Landing (VL) Pad Facility Outline with Safety Zones .....	338
Figure 8-24. Vertical Landing (VL) Pad Facility Cross Section Gradient.....	339
Figure 8-25. Vertical Landing (VL) Pad Facility Clear Zone and Accident Potential Zone.....	339
Figure 8-26. Vertical Landing (VL) Pad Approach Surface Isometric.....	340
Figure 8-27. Vertical Landing (VL) Pad Facility Clear Zone and Accident Potential Zone for F-35B Only .....	341
Figure 8-28. Vertical Landing (VL) Pad Markings.....	342
Figure 8-29. Vertical Landing (VL) Pad Lighting.....	343
Figure 8-30. VL Pad Pavement Surface Types .....	344
Figure 8-31. Forward Operating Base STOVL Facility Outline.....	356
Figure 8-32. Forward Operating Base STOVL Facility with Clearance Zones.....	357
Figure 8-33. Forward Operating Base STOVL Facility Longitudinal Gradient .....	357
Figure 8-34. Forward Operating Base STOVL Facility Transverse Section .....	358
Figure 8-35. Forward Operating Base STOVL Facility Departure Clearance Surface and Clear Zone .....	358
Figure 8-36. Forward Operating Base STOVL Facility Departure Clear Zones and APZs.....	359
Figure 8-37. Forward Operating Base STOVL Facility Isometric.....	360
Figure 8-38. Forward Operating Base STOVL Facility Imaginary Surfaces .....	361
Figure 8-39. Forward Operating Base STOVL Facility Runway End Detail.....	362
Figure 8-40. Forward Operating Base STOVL Facility Markings.....	363
Figure 8-41. Forward Operating Base STOVL Facility Lighting.....	364
Figure 8-42. STOVL FOB Pavement Surface Types.....	364
Figure 8-43. Tilt-Rotor Outlying Landing Field (OLF) Facility Outline .....	373
Figure 8-44. OLF Facility with Clear Zones .....	373
Figure 8-45. OLF Facility Longitudinal Gradient.....	374
Figure 8-46. OLF Facility Transverse Section .....	374
Figure 8-47. OLF Facility Approach-Departure Clearance Surface and Clear Zone ..	375
Figure 8-48. OLF Facility Clear Zones and APZs.....	375
Figure 8-49. OLF Facility Isometric .....	376
Figure 8-50. OLF Facility Imaginary Surfaces .....	377
Figure 8-51. Tilt-Rotor OLF Pavement Surface Types .....	378
Figure 9-1. MQ-1/9 Predator/Gray Eagle/Reaper Primary Surface End Details.....	385
Figure 9-2. RQ-7Bv2 Shadow Primary Surface End Details .....	385

Figure 9-3. MQ-1/9 Predator/Gray Eagle/Reaper Approach-Departure Clearance Surface Profile .....	386
Figure 9-4. RQ-7Bv2 Shadow Approach-Departure Clearance Surface Profile .....	387
Figure 9-5. MQ-1/9 Predator/Gray Eagle/Reaper Runway Isometric Airspace Imaginary Surfaces.....	388
Figure 9-6. MQ-1/9 & RQ-7Bv2 Runway Plan and Profile Airspace Imaginary Surfaces.....	389
Figure 9-7. Mooring Layout for the RQ-4A Global Hawk.....	403
Figure 9-8. Parking Area Dimensions for RQ-4A and RQ-4B Global Hawk .....	404
Figure 9-9. Standard Army MQ-1C Hangar Access Apron.....	405
Figure B4-1. Windrose Blank Showing Direction and Divisions (16-Sector [22.5°] Windrose) .....	441
Figure B4-2. Windrose Blank Showing Direction and Divisions (36-Sector [10°] Windrose) .....	442
Figure B4-3. Completed Windrose and Wind Velocity Equivalents (16-Sector [22.5°] Windrose) .....	443
Figure B4-4. Windrose Analysis .....	445
Figure B4-5. Allowable Wind Variation for 19 Kilometer-per-Hour (10.4 Knot) and 28 Kilometer-per-Hour (15 Knot) Beam Wind Components .....	447
Figure B10-1. Magnetic Field Survey Sheet.....	464
Figure B10-2. Typical Type I Compass Rose Control Point and Marking Layout .....	466
Figure B10-3. Type II Compass Rose Control Point and Marking Layout .....	467
Figure B10-4. Compass Calibration Pad Survey Data Marking.....	468
Figure B11-1. Army Mooring Point .....	472
Figure B11-2. Army Load Testing of Mooring Points.....	473
Figure B11-3. Army Rotary-Wing Allowable Mooring Point Spacing .....	475
Figure B11-4. Army Rotary-Wing Mooring Points Layout.....	476
Figure B11-5. Slab Reinforcement for Army Mooring Point.....	477
Figure B11-6. Mooring Point for Existing Rigid Pavement for Pavement Thickness Greater Than 150 Millimeters (6 Inches).....	478
Figure B11-7. Army Rotary-Wing Mooring Pad Detail .....	480
Figure B11-8. Army Mooring Point for Grassed Areas, Flexible Pavement, or Rigid Pavement - Thickness Less Than 150 millimeters (6 inches) .....	481
Figure B11-9. Mooring and Ground Point Layout for Rotary-Wing Parking Space.....	484
Figure B11-10. Example of Air Force Multiple Tiedown Layout for Fixed-Wing Aircraft .....	485
Figure B11-11. Air Force Aircraft Tiedown, Profile .....	486
Figure B11-12. Air Force Aircraft Tiedown, Plan .....	487
Figure B11-13. Navy and Marine Corps T-56 Mooring Eye/Tiedown Detail .....	488
Figure B11-14. Navy and Marine Corps T-56 Retrofit Detail Option 1 .....	489
Figure B11-15. Navy and Marine Corps T-56 Retrofit Detail Option 2 .....	490
Figure B15-1. Example of 267 kN (60,000 LB) Square Aircraft Anchor Block and Cross Section.....	535
Figure B15-2. Example of 267 kN (60,000 lb) Square Anchor Block, Cross Section A-A and B-B.....	536
Figure B15-3. Example of 267 kN (60,000 lb) Octagonal Anchor Block.....	537

Figure B15-4. Example of 267 kN (60,000 lb) Octagonal Anchor Block, Cross-Sections  
C-C, D-D, and E-E ..... 538

Figure B15-5. Standard 445 kN (100,000 lb) Thrust Block Steel Anchor ..... 539

Figure B15-6. Standard 445 kN (100,000 lb) Thrust Block Steel Anchor Dimensions. 540

Figure B15-7. Standard 445 kN (100,000 lb) Thrust Concrete Block - Plan View ..... 541

Figure B15-8. Standard 445 kN (100,000 lb) Thrust Concrete Block - Profile View .... 542

Figure B16-1. Runway Profile and New Control Tower ..... 546

Figure B16-2. Minimum Eye-Level Determination – Tower Higher than Runway End 547

Figure B16-3. Minimum Eye-Level Measurement – Tower Lower than Runway End . 548

Figure B17-1. BRL – Plan View..... 556

Figure B17-2. BRL – Profile View..... 557

CANCELLED

TABLES

Table 3-1. Runway Classification by Aircraft Type .....	34
Table 3-2. Runways .....	35
Table 3-3. Army Class A Runway Lengths .....	43
Table 3-4. Overruns .....	67
Table 3-5. Clear Zones.....	69
Table 3-6. Accident Potential Zones (APZs) .....	72
Table 3-7. Airspace Imaginary Surface .....	73
Table 3-8. Imaginary Surfaces Minimum Clearances over Highway, Railroad, Waterway, and Trees.....	79
Table 4-1. Rotary-Wing Runways .....	84
Table 4-2. Rotary-Wing Helipads and Hoverpoints .....	90
Table 4-3. Rotary-Wing Landing Lanes.....	106
Table 4-4. Shoulders for Rotary-Wing Facilities .....	108
Table 4-5. Overruns for Rotary-Wing Runways and Landing Lanes .....	109
Table 4-6. Rotary-Wing Runway and Landing Lane Clear Zone and APZ .....	111
Table 4-7. Rotary-Wing Imaginary Surface for VFR Approaches.....	112
Table 4-8. Rotary-Wing Imaginary Surfaces for IFR Approaches .....	115
Table 5-1. Fixed-Wing Taxiways .....	124
Table 5-2. Rotary-Wing Taxiways .....	129
Table 5-3. Rotary-Wing Taxiway Shoulders .....	130
Table 5-4. Runway/Taxiway Intersection Fillet Radii.....	132
Table 5-5. Taxiway/Taxiway Intersection and Taxiway Turns Fillet Radii.....	132
Table 5-6. Towedways .....	136
Table 5-7. Taxitraks.....	140
Table 6-1. Fixed-Wing Aprons.....	149
Table 6-2. Rotary-Wing Aprons for Army Airfields.....	166
Table 6-3. Magnetic Survey Frequency Requirements .....	192
Table 6-4. Minimum Separation Distance on Tanker or Bomber Alert Aprons from the Centerline of a Through Taxilane to a Parked Aircraft .....	203
Table 6-5. Wash Rack Clearances From Aircraft to Curb .....	213
Table 6-6. Hangar Access Apron .....	221
Table 6-7. Navy/Marine Corps Aircraft Parking Spacing, Helicopter Aircraft, 90-Degree Parking.....	227
Table 6-8. Navy/Marine Corps Aircraft Parking Spacing, Propeller Aircraft, 90-Degree Parking.....	227
Table 6-9. Navy/Marine Corps Aircraft Parking Spacing, Jet Aircraft, 90-Degree Parking.....	228
Table 6-10. Navy/Marine Corps Aircraft Parking Spacing, Jet Aircraft, 45-Degree Parking.....	231
Table 7-1. Runways for LZs .....	238
Table 7-2. C-17 LZ Runway Lengths.....	241
Table 7-3. Taxiways for LZs .....	242
Table 7-4. Aprons for LZs.....	245
Table 7-5. Overruns for LZs .....	246



Table 7-6. Accident Potential Zones (APZs) and Exclusion Areas for LZs.....	248
Table 7-7. Runway End Clear Zone for LZs.....	250
Table 7-8. Imaginary Surfaces for LZs.....	251
Table 7-9. Runway Separation for Simultaneous Operations.....	258
Table 7-10. Infrared Transmitting Filter Specifications.....	272
Table 8-1. LHD STOVL Facility Deck Criteria.....	300
Table 8-2. LHD STOVL Facility Airspace Imaginary Surfaces.....	304
Table 8-3. LHD STOVL Facility Clear Zone and APZs.....	308
Table 8-4. Vertical Landing (VL) Pad Criteria.....	331
Table 8-5. Vertical Landing (VL) Pad Airspace Imaginary Surfaces.....	333
Table 8-6. Vertical Landing (VL) Pad Clear Zone and APZs.....	337
Table 8-7. Forward Operating Base (FOB) STOVL Runway Criteria.....	350
Table 8-8. Forward Operating Base (FOB) STOVL Airspace Imaginary Surfaces.....	353
Table 8-9. Forward Operating Base (FOB) STOVL Facility Clear Zone and APZs.....	356
Table 8-10. Tilt-Rotor Outlying Landing Field (OLF) Facility Criteria.....	368
Table 8-11. Tilt-Rotor Outlying Landing Field (OLF) Airspace Imaginary Surfaces.....	369
Table 8-12. Tilt-Rotor Outlying Landing Field (OLF) Clear Zone and APZs.....	372
Table 9-1. Separation Distance Between Runways.....	381
Table 9-2. UAS Runways.....	382
Table 9-3. UAS Overruns.....	390
Table 9-4. UAS Clear Zones.....	391
Table 9-5. UAS Accident Potential Zones.....	393
Table 9-6. UAS Airspace Imaginary Surfaces.....	394
Table 9-7. UAS Taxiways.....	397
Table 9-8. UAS Toweys.....	399
Table 9-9. UAS Hangar Access Apron.....	401
Table B11-1. Army Pier Length and Depths for Tiedowns.....	482
Table B12-1. Safe Standoff Distances Aft of Aircraft Tail (Based on 51-mm [2-in] Asphalt Shoulder Pavement Thickness).....	493

THIS PAGE INTENTIONALLY BLANK

CANCELLED

## CHAPTER 1 GENERAL REQUIREMENTS

### 1-1 BACKGROUND.

This Unified Facilities Criteria (UFC), UFC 3-260-01, provides requirements for evaluating, planning, programming, and designing airfields and heliports. The requirements contained in this UFC apply to Army, Navy, and Air Force facilities unless specifically referenced to a single service. This UFC is not intended as a substitution for thorough review during design by individual Program Managers, Engineers and Operations Staff in the appropriate service.

The desired goal of this UFC is to maintain consistency in Airfields and Heliports requirements across the Army, Navy and Air Force. This UFC is not intended as an operational manual.

Each service has unique requirements to fulfill specific missions. This document will highlight any key differences that impact the airfield or heliport layout and design. Where one Service's criteria vary from the other Services' criteria, it is noted in the text.

### 1-2 PURPOSE AND SCOPE.

#### 1-2.1 Purpose.

This manual provides standardized airfield, heliport, and airspace criteria for the geometric layout, design, and construction of runways, helipads, taxiways, aprons, landing zones (LZs), short take-off and vertical landing (STOVL) facilities, unmanned aircraft system (UAS) facilities and related permanent facilities to meet sustained operations.

#### 1-2.2 Scope.

This manual prescribes dimensional and geometric layout criteria for safe standards for airfields, landing zones, heliports and helipads, and related permanent facilities, as well as the navigational airspace surrounding these facilities. Manned aircraft facilities are addressed in Chapters 1 through 6. Landing Zones used by C-130 and C-17 aircraft are addressed in Chapter 7. Airfield facilities used by Short Take-off Vertical Landing (STOVL) aircraft are addressed in Chapter 8. Airfield facilities for Unmanned Aircraft Systems (UAS) are addressed in Chapter 9. Criteria in this manual pertain to all Department of Defense (DoD) military facilities in the United States, its territories, trusts, and possessions, and unless otherwise noted, to DoD facilities overseas on which the United States has vested base rights. For DoD facilities overseas; if a written agreement exists between the host nation and the DoD that requires application of either North Atlantic Treaty Organization (NATO), International Civil Aviation Organization (ICAO), or Federal Aviation Administration (FAA) standards, those standards will apply as stipulated within the agreement; however, DoD proponents will apply the criteria within this manual to the maximum extent practicable. United States Air Force (USAF) bases

within the European theater may be authorized by Headquarters United States Forces in Europe (HQ USAFE) to use NATO criteria (See USAFEI 32-1007). Tenant organizations on civil airports in the continental United States (CONUS) will use these criteria to the extent practicable; otherwise, FAA criteria will apply. Specifically, on airfield areas that are joint-use or with restrictions and clear zones generated by joint-use areas, the FAA criteria contained in FAA Advisory Circular (AC) 150/5300-13 is applicable. For areas where airfield surfaces are National Guard Bureau (NGB), Army Reserve or Air Force Reserve controlled, whether fee-owned or exclusive use leased, the criteria contained in this manual are applicable.

### **1-2.2.1 Terminal Instrument Procedures (TERPS).**

In addition to a local TERPS review, modifications to existing facilities, temporary construction, airfield surface modifications, maintenance or construction requiring equipment on or near the airfield flying environment, and construction of new facilities must be closely coordinated with the Air Force major command (MAJCOM), US Army Aeronautical Services Agency (USAASA) and United States Army Aeronautical Services Detachment, Europe (USAASDE), and Naval Flight Information Group (NAVFIG) to determine the impact to existing and planned instrument approach and departure procedures. The criteria in this manual do not address instrument flight procedures. TERPS evaluations and processes are described in FAA Order 8260.3 and Air Force Instruction (AFI) 11-230. TERPS criteria shall be considered when designing or modifying airfields and facilities on airfields that are used under instrument flight rules (IFR).

### **1-2.2.2 Objects Affecting Navigable Airspace.**

Modifications to existing facilities and construction of new facilities must consider effects on navigable airspace IAW Federal Aviation Regulation (FAR) Part 77 and may require that an FAA Form 7460-1 and/or 7460-2 be filed with the administrator. See Appendix B, Section 5, to determine when the FAA Form 7460-1 must be filed. FAA Form 7460-2 is used to notify the FAA of progress or abandonment, as requested, on the form. The FAA Service Area routinely includes this form with a determination when such information will be required. The information is used for charting purposes, to change affected aeronautical procedures, and to notify pilots of the location of the structure. Go to <https://oeaaa.faa.gov/oeaaa/external/portal.jsp> for more information on these forms and instructions for using E-file to submit the form to FAA. The criteria for determining obstructions to navigable airspace have been identified in this manual. The designer must consult this manual during the design process to identify obstructions to airspace and file FAA Form 7460-1 when required. The Construction Proponent/Community Planner will coordinate with the airfield/airspace manager and aviation safety officer before filing the form with the FAA. For facilities outside the United States (US) and its trust territories, host nation criteria apply off base. If the criteria in this manual are more stringent, this manual should be used to the maximum extent practical.

### **1-2.2.3 Navigational Aids (NAVAIDS) and Lighting.**

NAVAIDS and airfield lighting are integral parts of an airfield and must be considered in the planning and design of airfields and heliports. NAVAID location, airfield lighting, and the grading requirements of a NAVAID must be considered when locating and designing runways, taxiways, aprons, and other airfield facilities.

#### **1-2.2.4 Special Tilt-Rotor Aircraft Considerations (V-22).**

The V-22 is a tilt-rotor aircraft that can operate both as a fixed-wing aircraft or a rotary-wing aircraft. At permanent shore establishments, the V-22 will be considered a fixed-wing aircraft for the purposes of determining facilities requirements. The runway will be planned according to critical field length. Chapter 3 contains V-22 fixed-wing criteria with noted exceptions. Additionally, rotary-wing facilities such as helipads may be utilized for V-22 operations. Chapter 4 contains V-22 rotary-wing criteria with noted exceptions. V-22 facilities require upgraded high temperature materials where stationary operations are expected for extended periods of times. V-22 apron requirements are provided in Chapter 6.

### **1-3 APPLICABILITY.**

#### **1-3.1 Existing Facilities.**

Existing airfield facilities built under a previous standard need not be immediately modified nor upgraded to conform to the criteria in this manual if these facilities meet current mission requirements. This includes cases where runways may lack paved shoulders or other physical features because they were not previously required or authorized. However, when a change in the facility mission occurs, new features are added, or the facility is repaired (when repair is accomplished by replacement), the airfield facilities must be re-evaluated and upgraded where deficient using current criteria and the new mission requirements to eliminate the deficiency. A change in the facility mission can be a new aircraft or weapons platform, revised facility use, facility repurposing, or other change that may present a new risk, assumption, or loading not previously considered or evaluated for the existing facility.

The criteria in this UFC apply to DoD aviation facilities located in the US, its territories, trusts and possessions. Where a DoD aviation facility is a tenant on a civil airport see paragraph 1-3.5.

Where a DoD aviation installation complex is host to a civilian aviation operation, the criteria in this UFC applies. Apply this criteria to the extent practicable at overseas locations where the DoD have vested rights. While the criteria in this UFC is not intended for use in theater of operations situations, it may be used as a guideline when prolonged use is anticipated and no other standard has been designated. Once upgraded, facilities must be maintained at a level that will sustain compliance with current standards. DoD personnel must identify the status of features and facilities on airfield maps as exempt (because they were constructed under a previous, less stringent standard), as a permissible deviation (authorized as a deviation to airfield criteria and sited appropriately), or as a violation, with or without approved waiver. For

the Air Force only, Building Restriction Lines (BRLs) encompass vertical facilities along the flight line that are exempt because they were constructed under previous standards. For other items or features, annotate the airfield map to identify the status of the facility or feature and the date of construction or waiver number. See Appendix B, Section 17, for the guidelines used to establish the BRL.

### **1-3.2 Modification of Existing Facilities.**

When existing airfield facilities are modified, construction must conform to the criteria established in this manual unless the criteria is waived in accordance with paragraph 1-7. Modified portions of facilities must be maintained at a level that will sustain compliance with the current standards. Exception: For the USAF, parallel taxiways constructed less than 305 meters (m) (1,000 feet (ft)) from the runway centerline may be resurfaced or extended without a waiver if the extension is less than 50 percent of the total taxiway length and the location does not impact TERPS criteria.

### **1-3.3 New Construction.**

The criteria established in this manual apply to all new facilities. All new construction will comply with the criteria established in this manual unless the appropriate waivers are obtained as outlined in Appendix B, Section 1. For the USAF, new facilities within the appropriate category code may be constructed without a waiver if they are behind and beneath the boundaries of the BRL (see Appendix B, Section 17). All site plans for new facilities that will be sited within this area will clearly delineate the limits (including elevation) of the BRL and the relationship to the proposed facility. New facilities must be maintained at a level that will sustain compliance with the current standards.

### **1-3.4 Metric Application.**

Geometric design criteria established in this manual are expressed in SI units (metric) and inch-pound units (English). These metric values are based on aircraft-specific requirements rather than direct conversion and rounding. This results in apparent inconsistencies between metric and inch-pound (English) dimensions. For example, 150-ft-wide runways are shown as 46 m, and 150-ft-wide aircraft wash racks are shown as 45 m. Runways need the extra meter in width for aircraft operational purposes; wash racks do not. English dimensions apply to new airfield construction at US facilities. At OCONUS facilities, apply dimensional units customarily used for construction at the facility. To avoid changes to existing airfield obstruction maps and compromises to flight safety, airfield and heliport imaginary surfaces and safe wingtip clearance dimensions are shown as a direct conversion from inch-pound to SI units.

### **1-3.5 Military Activities on Civil Owned Airfields.**

DoD installations on municipal airports or FAA-controlled airfields must apply FAA criteria to facilities such as runways and taxiways that are jointly used by civilian and military aircraft. The portions of facilities that are for military use only, such as aircraft parking aprons, must apply DoD criteria.

### **1-3.6 USAFE Installations.**

HQ USAFE Instruction (USAFEI) 32-1007 provides guidance for when NATO criteria may be used in lieu of the standards provided in this manual.

### **1-3.7 Gravel Runways at Radar Sites.**

As much as possible, the criteria from Chapter 7 will be applied to the gravel runways currently in use at radar sites throughout Alaska. It is understood that many of these runways were constructed in such a way that terrain constraints allow traffic in only one direction, and that slope and obstacle clearances can be well outside normal criteria.

## **1-4 GENERAL BUILDING REQUIREMENTS.**

Comply with UFC 1-200-01, General Building Requirements. UFC 1-200-01 provides applicability of model building codes and government unique criteria for typical design disciplines and building systems, as well as for accessibility, antiterrorism, security, high performance and sustainability requirements, explosive and other safety. Use this UFC in addition to UFC 1-200-01 and government criteria referenced therein.

### **1-4.1 Explosives Safety.**

This document does not contain requirements for explosives safety. Facilities that involve DoD Ammunition and Explosives (AE) storage, handling, maintenance, manufacture or disposal, as well as facilities within the explosives safety quantity distance (ESQD) arcs of AE facilities, must comply with the requirements found in DoD 6055.09-M, as well as implementing Service criteria found in DA PAM 385-64 (Army), NAVSEA OP 5 (Navy and Marine Corps), and AFMAN 91-201 (Air Force). DoD facilities exposed to potential explosion effects from AE belonging to other nations are also required to meet DoD and Service explosives safety criteria. See also Appendix B Section 9.

### **1-4.2 Physical Security.**

That part of security concerned with physical measures designed to safeguard personnel; to prevent or delay unauthorized access to equipment, installations, material, and documents; and to safeguard them against espionage, sabotage, damage, and theft.

Regulatory requirements for security of assets can have a significant impact on the planning and design of airfields and heliports. The arms, ammunition, explosives, and electronic devices associated with aircraft, as well as the aircraft themselves, require varying types and levels of protection. Operational security of the airfield is also a consideration.

Protective features such as barriers, fences, lighting, access control, intrusion detection, and assessment must be integrated into the airfield planning and design process to minimize problems with aircraft operations and safety requirements. This is discussed

further in Chapter 2 and in unified facilities criteria UFC 4-020-01, DoD Security Engineering Facilities Planning Manual. The protective measures will be included in the design based on risk and threat analyses with an appropriate level of protection, or will comply with security-related requirements.

#### **1-5 SERVICE REQUIREMENTS.**

When criteria differ among the various Services, the criteria for the specific Service are noted. For the USAF, all work orders processed for work within the airfield environment must be signed by the airfield manager before work may proceed in accordance with paragraph 1-8, "USAF Work Order Coordination and Authorization."

#### **1-6 THEATER OF OPERATIONS.**

Standards for theater-of-operations facilities are contained in US Army TM 3-34.48-2. For C-17 and C-130 landing zones see Chapter 7 of this manual.

#### **1-7 WAIVERS TO CRITERIA.**

Mil-STD 3007 contains the overarching process for "waivers" or "exemptions" to this and all UFCs even though this UFC details additional waiver processes for operational and safety authorities. The term "waiver" herein may refer to either a temporary "waiver" or permanent "exemption" with regard to Mil-STD 3007. Each DoD Service component is responsible for setting the administrative procedures necessary to process and grant formal design or operational waivers. "Waivers" in general herein is a term that also indicates intent to seek approval for some non-compliance to criteria in this UFC. This document is intended for new construction; however, it is acknowledged that other authorities may reference it for other supplemental uses and purposes. Although this is not an operational document, these other authorities may require their own respective waiver processes. Waivers to the criteria contained in this manual will be processed in accordance with Appendix B, Section 1. If a waiver affects instrument approach and departure procedures as defined in TERPS (FAA Order 8260.3/ TM 95-226/OPNAVINST 3722.16C), the DoD Service component processing the waiver must also coordinate its action with the applicable TERPS approving authority. Certain existing facilities may require the supported aircraft activity to have an operational waiver to continue to operate, such as to land/takeoff on a shorter runway, operate on a taxiway that is not wide enough, or operate with reduced wingtip clearances for interior hangars or sunshades. These are operational/safety waivers and not design criteria waivers for new construction. Design criteria waivers address design considerations of new facilities while operational/safety waivers address airfield safety/risk considerations and operational mitigations. The Service authority owning the airfield and/or the mission aircraft will determine the requirements needed to safely operate on the existing facilities as described in Appendix B, Section 1.

#### **1-8 USAF WORK ORDER COORDINATION AND AUTHORIZATION.**



All work orders processed for work in the airfield environment must first be coordinated with communications, civil engineering, safety, security forces, and TERPS, and then signed by the airfield manager before work may proceed. The airfield manager (AM) and flight safety must be notified no less than five working days prior to beginning construction/work on the airfield. This does not apply to emergency repairs.

**1-9            FAA NOTICE OF PROPOSED CONSTRUCTION OR ALTERATION.**

Construction of new airfields, heliports, helipad or hoverpoints, or modifications to existing facilities affecting the use of airspace or changes in aircraft densities may require notification to the FAA Administrator. When a new runway, heliport, helipad or hoverpoint is planned or an existing landing surface will be extended or modified, in addition to local permitting requirements, file FAA Form 7480-1 in accordance with FAA Order 7400.2 via <https://oeaaa.faa.gov/oeaaa/external/portal.jsp>. Additionally, the FAA must be notified of all construction that affects air navigation at DoD airfields and civil airports in the US and its territories. FAA Form 7460-1 must be submitted to the FAA at least 45 days prior to the start of construction, in accordance with Federal Aviation Regulations (FAR), Part 77, subpart B. Airspace surface penetrations will be noted. Applications may be obtained and are filed with the appropriate FAA Service Area. For DoD facilities overseas, similar requirements by the host country, NATO, or ICAO may be applicable.

**1-10           CONSTRUCTION PHASING PLAN.**

A construction phasing plan, as discussed in Appendix B, Section 14, must be included in the contract documents. This is a mandatory requirement for USAF and Army installations whether work will be accomplished by contract or in-house (see Appendix B, Section 14). Also see the procedures for obtaining temporary waivers for construction in Appendix B, Section 1.

**1-11           ZONING.**

Existing facilities should be modified, and new facilities will be sited and constructed consistent with Service-specific AICUZ compatible land use standards and in a manner that will encourage local municipalities to adopt land use plans and zoning regulations to protect people, property and the installation's flying mission. Land uses compatible with flight operations are defined in DoD Instruction (DoDI) 4165.57 and Service-specific AICUZ directives.

**1-12           REFERENCES.**

Appendix A contains a list of documents referenced in this manual.

**1-13           GLOSSARY.**

Appendix C contains acronyms, abbreviations and terms.

**1-14           USE OF TERMS.**

These terms, when used in this manual, indicate the specific requirements listed here:

- Will or Must: Indicates a mandatory and/or required action.
- Should: Indicates a recommended, advisory, and/or desirable action.
- May or Can: Indicates a permissible action.

CANCELLED

## CHAPTER 2 AVIATION FACILITIES PLANNING

### 2-1 APPLICABILITY.

The criteria in this chapter apply to DoD aviation facilities planning, but may be supplemented by additional service-specific guidance. Navy aviation planning is covered in NAVFAC publication UFC 2-000-05N. Aviation facilities planning for the Air Force is discussed in AFIs 32-7062, 32-7063, 32-1024, and Air Force Manual (AFMAN) 32-1084. In some cases, Army, Air Force and Navy agencies reference documents have been noted.

#### 2-1.1 Manual Usage.

Integration of aviation facilities planning with other DoD planning processes entails broad considerations. For example, the National Environmental Policy Act of 1969 (NEPA) has significantly affected aviation facilities planning by requiring that environmental impacts be considered early and throughout the planning process. In using this manual, planners should recognize that planning an aviation facility requires not only planning for runways, taxiways, aprons, and buildings, but also considering environmental factors, land use considerations, airspace constraints, and surrounding infrastructure.

#### 2-1.2 Planning Process.

Aviation facilities planning involves collecting data, forecasting demand, determining facility requirements, analyzing alternatives, and preparing plans and schedules for facility development. The aviation facilities planning process must consider the mission and use of the aviation facility and its effect on the general public. The planning process cannot be completed without knowing the facility's primary mission and assigned organization and types of aircraft. Figure 2-1 provides general steps in the aviation facilities planning process.

#### 2-1.3 Planning Elements.

The elements of an aviation facility's planning process will vary in complexity and degree of application, depending on the size, location, function, and problems of the facility. The technical steps described in this manual should be undertaken only to the extent necessary to produce a well-planned aviation facility. Each DoD installation with an airfield should have an airfield Area Development Plan (ADP) to address airfield development, i.e., projects (such as pavement, lighting, grading, tree removal), waivers, and obstruction removal. The ADP is a part of the base comprehensive plan.

Figure 2-1. Aviation Facilities Planning Process

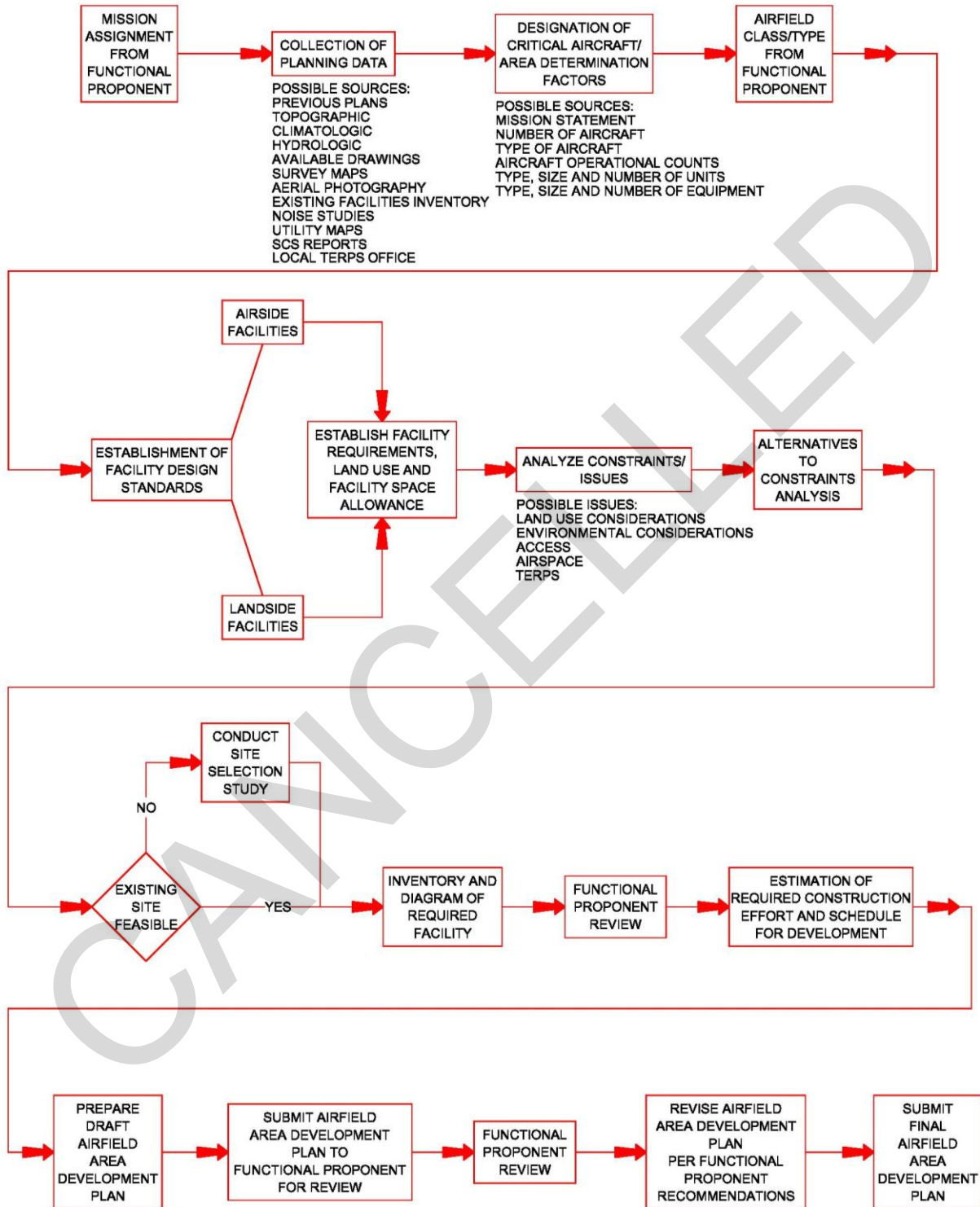

## **2-1.4 Guidance.**

This chapter is structured and organized to provide guidance to planners intending to plan, design, or modify an aviation facility to comply with standardized criteria.

## **2-1.5 Additional Planning Factors.**

As discussed in Chapter 1, additional planning factors such as pavement design, airfield marking, and TERPS must be considered when planning aviation facilities.

## **2-1.6 Space Allowances.**

The primary source for determining authorized space allowances for Army aviation facilities is the Facility Planning System (FPS) contained in the Real Property Planning and Analysis System (RPLANS). Space allowances are presented in UFC 2-000-05N for Navy facilities and AFMAN 32-1084 for Air Force facilities.

## **2-2 JUSTIFICATION.**

### **2-2.1.1 Aviation Facilities Planning.**

Aviation facilities must be planned, programmed, and constructed in accordance with the Area Development Plan process. An ADP is developed and approved through an established planning process as discussed in paragraph 2-4. The master plan process requires assessing alternatives to determine the best alternative, or the best combination of alternatives, to overcome deficiencies at an aviation facility. Consideration must be given to construction alternatives (to construct new, modify, or upgrade a substandard facility) combined with operational alternatives (rescheduling and sharing facilities, changing training or mission) to determine the best plan for meeting facility requirements. As a minimum, each alternative considered must identify the changes to the mission, personnel, weapons systems and equipment, and any other impact to the facility. Construction of a new aviation facility is authorized when: (1) operational alternatives have been assessed and the conclusion is that the alternatives are not viable or executable options; or (2) existing facilities have been assessed as inadequate to meet the mission, and new airside and/or landside facilities are not feasible.

### **2-2.2 Existing Facility Assessment.**

When the mission to be supported changes, a determination must be made if a facility built to a previous design standard meets or exceeds the current design standard and is no longer needed by the current mission, such as wider/longer runway/taxiway/apron or multiple runways (crosswind/parallel, etc.) than currently required. In these cases, the long term cost of keeping the excess pavement as is, must be documented and analyzed to determine if keeping the facility or bringing the facility into current required design standards is more safe and/or cost effective in the long term.

### **2-2.2.1 Navy/Marine Corps**

Approval from Headquarters Naval Facilities Engineering Command (NAVFACENGCOCM) must be obtained before revising safety clearances at existing airfield pavements to conform to new standards herein. NAVFACENGCOCM will coordinate the approval with the Naval Air Systems Command (NAVAIR) and Chief of Naval Operations (CNO)/Commandant Marine Corps (CMC), as required.

### **2-2.3 Joint Use Facilities.**

Use of existing facilities on a civil airfield, or the airfield of another Service, should be considered when feasible.

## **2-3 GENERAL PLANNING CONSIDERATIONS.**

### **2-3.1 Goals and Objectives.**

The goals and objectives of planning an aviation facility, as set forth in this manual, are to ensure sustained, safe, economical, and efficient aircraft operations and aviation support activities. Planners must consider both the present and potential uses of the aviation facility during peacetime, mobilization, and emergency operations. Engineers/planners should assist operations personnel with the planning and programming, definition and scope, site selection, and design of the facility. See UFC 2-100-01, Installation Master Planning, for additional guidance.

### **2-3.2 Requirements.**

Each functional proponent is responsible for providing the appropriate operational information to be used in the planning of an aviation facility. In addition, planning should be coordinated with all users (operations, air traffic control, and safety) of the aviation facility, including the FAA, to determine immediate and long-range uses of the aviation facility.

#### **2-3.2.1 Operational Information.**

Functional proponents will provide, at a minimum, the existing and projected operational information needed for planning aviation facilities:

- Mission statements
- Aircraft operational counts, traffic levels, and traffic density
- Type, size, and number of units/organizations and personnel
- Type, size, and number of equipment (e.g., aircraft, weapons systems, vehicles)
- Once these items are established, land requirements to support the aircraft mission can be established.

### **2-3.2.2 Engineering Information.**

Engineering information provided will include, as a minimum: graphical maps and plans, facility condition assessments, and tabulation of existing facilities.

### **2-3.3 Safety.**

The planning and design of an aviation facility will emphasize safety for aircraft operations. This includes unobstructed airspace and safe and efficient ground movements. Protect air space by promoting conscientious land use planning, such as compatible zoning and land easement acquisition.

#### **2-3.3.1 Wildlife Hazards Mitigation.**

Planning and design must comply with installation specific bird and animal strike hazard or other wildlife hazards mitigation plans and FAA/AC150/5200-33B to minimize aircraft wildlife strikes.

- For Navy and Marine Corps: Use the Installation specific Wildlife Hazards Mitigation Plan (WHMP) in accordance with CNICINST 3750.1.
- For Army: The requirements for a Wildlife Hazard Management Plan as spelled out in AR 95-2 shall be adhered to.
- For Air Force: Use AFI 91-212 Bird/Wildlife Aircraft Strike Hazard (BASH) Management Program. New proposed storm water features on airfields will be coordinated with and through the local Bird Hazard Working Group during the design stage.

### **2-3.4 Design Aircraft.**

Typically, aviation facilities are designed for a specific aircraft known as the "critical" or "design" aircraft, which is the most operationally and/or physically demanding aircraft to make substantial use of the facility. The critical or design aircraft is used to establish the dimensional requirements for safety parameters such as approach protection zones; lateral clearance for runways, taxiways and parking positions; and obstacle clearance. In many cases, the "geometric" design aircraft (most demanding based on size or performance) may not be the same aircraft as the "pavement" design aircraft (most demanding for pavement load design).

### **2-3.5 Airspace and Land Area.**

Aviation facilities need substantial air space and land area for safe and efficient operations and to accommodate future growth or changes in mission support.

#### **2-3.5.1 Ownership of Clear Zones and Accident Potential Zones.**

When planning a new aviation facility or expanding an existing one, clear zones should, to the maximum extent possible, be either owned or protected through restrictive use easements. Ownership/control of the APZ should follow guidance in DoDI 4165.57.

### **2-3.5.2 Land Use within the Clear Zone and Accident Potential Zones.**

The AICUZ Program is the governing authority for land use in clear zones and accident potential zones (APZ). Requirements for land use in clear zones and APZs are provided in DoDI 4165.57 and Service-specific AICUZ directives. Additional restrictions for the graded area of the clear zone are provided in this manual.

### **2-3.5.3 Explosives.**

Where explosives or hazardous materials are handled at or near aircraft, safety and separation clearances are required. The clearances are based on quantity-distance criteria as discussed in Appendix B, Section 9.

### **2-3.5.4 Landside Safety Clearances.**

Horizontal and vertical operational safety clearances must be applied to landside facilities and will dictate the general arrangement and sizing of facilities and their relationship to airside facilities. Landside facilities will vary in accordance with the role of the mission. There are, however, general considerations that apply in most cases, such as:

- Adherence to standards in support of safety in aircraft operations
- Non-interference with line of sight or other operational restrictions
- Use of existing facilities
- Flexibility in being able to accommodate changes in aircraft types or missions
- Efficiency in ground access
- Priority accorded aeronautical activities where available land is limited

### **2-3.5.5 Helipads.**

Helipads are authorized at locations where aircraft are not permanently assigned but have a need for access based on supporting a continuing and recurrent aviation mission. For example, hospitals, depot facilities, and headquarters buildings are authorized one or more helipads. These facilities must be included in the approved airfield master plan.

### **2-3.5.6 Facilities Used by Multiple Services.**

At airfields used by multiple Services, the planning and design of facilities will be coordinated between the appropriate Services. The lead for coordination is the appropriate facilities/engineering echelon of the Service that owns the facilities.



### **2-3.5.7 Air Force Airfield Obstruction Mapping.**

The requirements and specifications for mapping are contained in AFI 32-7062.

## **2-4 PLANNING STUDIES.**

### **2-4.1 Master Plan.**

Knowledge of existing facilities, mission, and aircraft, combined with a realistic assumption of future requirements, is essential to the development of master plans. Principles and guidelines for developing master plans at an aviation facility are contained in UFC 2-100-01, Installation Master Planning, and these publications:

- Army: AR 210-20, Real Property Master Planning for Army Installations
- Air Force: AFI 32-7062
- Navy/Marines: NAVFAC, Naval Shore Infrastructure, Installation Development Plan Consistency Guide

### **2-4.2 Land Use Studies.**

Long-range land use planning is a primary strategy for protecting a facility from problems that arise from aviation-generated noise and incompatible land uses. Aircraft noise can adversely affect the quality of the human environment. Federal agencies are required to work with local, regional, state, and other Federal agencies to foster compatible land uses, both on and off the boundaries of the aviation facility. The Air Installations Compatible Use Zones (AICUZ) and Installation Compatible Use Zone (ICUZ) programs promote land use compatibility through active land use planning.

### **2-4.3 Environmental Studies.**

Development of an aviation facility, including expansion of an existing aviation facility, requires compliance with a variety of laws, regulations, and policies. The National Environmental Policy Act (NEPA) requires all Federal agencies to consider the potential environmental impacts of certain proposed projects and activities, as directed by DoD Directive (DoDD) 6050.7. Implementation of these regulations is defined for each Service in these documents: Army: AR 200-1, Environmental Protection and Enhancement; Air Force: Title 32, Code of Federal Regulations, Part 989 (32 CFR 989); and Navy and Marine Corps: OPNAVINST 5090.1B (MCO 5090.2). Four broad categories of environmental review for a proposed action exist. The decision to conduct one study or another depends on the type of project and the potential consequences of project to various environmental categories. Criteria for determining which type of study should be undertaken are defined in the environmental directives and regulations for each Service. Environmental studies should be prepared and reviewed locally. When additional assistance or guidance is necessary, this support may be obtained through various agencies such as the USA Army Air Traffic Services Command (ATSCOM)the US Army Corps of Engineers Transportation Systems Center (USACE TSC), the US

Army Corps of Engineers District Offices, NAVFAC Headquarters and Engineering Field Divisions, and the Air Force Civil Engineer Center (HQ AFCEC).

#### **2-4.3.1 Environmental Assessment (EA).**

The EA serves to analyze and document the extent of the environmental consequences of a proposed action. It evaluates issues such as existing and future noise, land use, water quality, air quality, and cultural and natural resources. The conclusion of the assessment will result in either a Finding of No Significant Impact (FONSI), or, if the consequences are significant and cannot be mitigated to insignificance, the decision to conduct an Environmental Impact Statement (EIS). This decision is typically made by the authority approving the study.

#### **2-4.3.2 Environmental Impact Statement (EIS).**

An EIS is the document that identifies the type and extent of environmental consequences created if the proposed project is undertaken. The primary purpose of the EIS is to ensure that NEPA policies and goals are incorporated into the actions of the Federal government. The EIS defines the impact and details what measures will be taken to minimize, offset, mitigate, or avoid any adverse effects on the existing environmental condition. Upon completion of an EIS, the decision maker will file a Record of Decision (ROD), which finalizes the environmental investigation and establishes consent to either abandon or complete the project within the scope of measures outlined in the EIS.

#### **2-4.3.3 Categorical Exclusion (CATEX).**

A CATEX is defined as a category of proposed action(s) that does not individually or cumulatively have the potential for significant effect on the environment and does not, therefore, require further environmental analysis in an EA or EIS. A list of actions that are categorically excluded is contained in the regulatory directives for each service.

#### **2-4.3.4 Exemption By Law and Emergencies.**

In specific situations, Congress may exempt the DoD from compliance with NEPA for particular actions. Emergency situations do not exempt the DoD from complying with NEPA but do allow emergency response while complying with NEPA.

#### **2-4.4 Aircraft Noise Studies.**

AICUZ and ICUZ are programs initiated to implement Federal laws concerning land compatibility from the perspective of environmental noise impacts. The ICUZ program is the Army's extension of the AICUZ program, which was initiated by the DoD and undertaken primarily by Air Force and Navy aviation facilities. Noise studies conducted under these programs describe the airfield noise environment and provide the installation with noise contour maps for use in managing noise and planning for compatible land use.

#### **2-4.4.1 Analysis.**

Due to the widely varied aircraft, aircraft power plants, airfield traffic volume, and airfield traffic patterns, aviation noise at installations depends on both aircraft types and operational procedures. Aircraft noise studies should be prepared for aviation facilities to quantify noise levels and possible adverse environmental effects, ensure that noise reduction procedures are investigated, and plan land for uses that are compatible with higher levels of noise. While many areas of an aviation facility tolerate higher noise levels, many aviation landside facilities and adjoining properties do not. Noise contours developed under the AICUZ and ICUZ studies are used to graphically illustrate noise levels and provide a basis for land use management and impact mitigation. The primary means of noise assessment is mathematical modeling and computer simulation. Guidance regarding when to conduct noise studies is contained in the environmental and AICUZ directive for each Service.

#### **2-4.5 Instrumented Runway Studies.**

The requirement to conduct an instrumented runway study is issued by the functional proponent. It is important to recognize that instrument landing capability provides for aircraft approaches at very low altitude ceilings or visibility distance minimums. Consequently, these lower approach minimums demand greater safety clearances, larger approach surfaces, and greater separation from potential obstacles or obstructions to air navigation.

### **2-5 SITING AVIATION FACILITIES.**

NOTE: While the general siting principles below are applicable to Navy aviation facilities, see UFC 2-000-05N for Navy-specific data and contacts.

#### **2-5.1 Location.**

The general location of an aviation facility is governed by many factors, including base conversions, overall defense strategies, geographic advantages, mission realignment, security, and personnel recruitment. These large-scale considerations are beyond the scope of this manual. The information in this chapter provides guidelines for siting aviation facilities where the general location has been previously defined.

#### **2-5.2 Site Selection.**

##### **2-5.2.1 Site Conditions.**

Site conditions must be considered when selecting a site for an aviation facility. The site considerations include, but are not limited to: topography, vegetative cover, existing construction, weather elements, wind direction, soil conditions, flood hazard, natural and man-made obstructions, adjacent land use, availability of usable airspace, accessibility of roads and utilities, and future expansion capability.

##### **2-5.2.2 Future Development.**

Adequate land for future aviation growth must be considered when planning an aviation facility. An urgent requirement for immediate construction should not compromise the plan for future development merely because a usable, but not completely satisfactory, site is available. Hasty acceptance of an inferior site can preclude the orderly expansion and development of permanent facilities. Initial land acquisition (fee or lease) or an aviation easement of adequate area will prove to be the greatest asset in protecting the valuable airfield investment.

### **2-5.2.3 Sites not on DoD Property.**

Site selection for a new airfield or heliport not located on a DoD- or Service-controlled property must follow FAA planning criteria and each Service's established planning processes and procedures for master planning as previously discussed in paragraph 2-4.1. Siting the aviation facility requires an investigation into the types of ground transportation that will be required, are presently available, or are capable of being implemented. All modes of access and transportation should be considered, including other airports/airfields, highways, railroads, local roadways, and internal roads. The facility's internal circulation plan should be examined to determine linear routes of movement by vehicles and pedestrians to ensure that an adequate access plan is achievable.

### **2-5.3 Airspace Approval.**

See Chapter 1, Paragraph 1-9.

### **2-5.4 Airfield Safety Clearances.**

#### **2-5.4.1 Dimensional Criteria.**

The dimensions for airfield facilities, airfield lateral safety clearances, and airspace imaginary surfaces are provided in this UFC.

#### **2-5.4.2 Air Force Missions at Army Facilities.**

Airfield safety clearances applicable to Army airfields that support Air Force cargo aircraft missions will be based on an Army Class B airfield. This will be coordinated between the Army and the Air Force.

#### **2-5.4.3 Prohibited Land Uses.**

AICUZ compatible land use standards prohibit certain land uses within the clear zone and APZs (APZ I and APZ II). These land uses include storage and handling of munitions and hazardous materials, and live-fire weapons ranges. See DoDI 4165.57 and Service-specific AICUZ directives for more information.

#### **2-5.4.4 Wake Turbulence.**

The problem of wake turbulence may be expected at airfields where there is a mix of light and heavy aircraft. At these airfields, some taxiway and holding apron design modifications may help to alleviate the hazards. Although research is underway to improve detection and elimination of the wake, at the present time the most effective means of avoiding turbulent conditions is provided by air traffic control personnel monitoring and regulating both air and ground movement of aircraft. Planners can assist this effort by providing controllers with line-of-site observation to all critical aircraft operational areas and making allowances for aircraft spacing and clearances in turbulence-prone areas. Additional information on this subject is available in FAA AC 90-23.

### **2-5.5 Storm Water Management Facilities.**

Use UFC 3-201-01 for airfield drainage design and manage stormwater in ways that will not compromise airfield safety. Design stormwater elements to minimize the attraction of hazardous wildlife by reducing open standing water such as retention ponds and stormwater wetlands to the maximum extent practicable. Some techniques that may be used to achieve these goals include:

- Increasing the separation distance between stormwater elements and the runway
- Using underground detention
- Using detention ponds with a maximum 48-hour detention period

**For Army:** No new above ground detention or retention ponds shall be sited within 1500' of the runway centerline as extended through the ends of the clear zones without prior approval from USACE-TSC.

### **2-5.6 Renewable Energy Systems.**

When siting renewable power generation facilities (e.g. photovoltaic cell arrays) in close proximity to airfields, issues like airspace coordination, glare and low-altitude testing and training route interference must be considered. See UFC 3-440-01, Facility-Scale Renewable Energy Systems and UFC 3-540-08, Utility-Scale Renewable Energy Systems for additional information and requirements. For Air Force, see AFI 32-7063 for additional guidance on hazards to aircraft flight zone.

## **2-6 AIRSIDE AND LANDSIDE FACILITIES.**

An aviation facility consists of four land use areas, further described in paragraphs 2-7 through 2-10.

- a. Airside Facilities – facilities associated with the movement and parking of aircraft.
- Landing and takeoff surfaces

- Aircraft ground movement and parking areas
- b. Landside Facilities – facilities not associated with the movement and parking of aircraft but are required for the facilities' mission.
- Aircraft maintenance areas
- Aviation operations support areas

## **2-7 LANDING AND TAKEOFF SURFACES.**

### **2-7.1 Runways and Helipads.**

Takeoff and landing surfaces are based on either a runway or helipad. The landing/takeoff surface consists of not only the runway and helipad surface, shoulders, and overruns, but also the approach slope surfaces, safety clearances, and other imaginary airspace surfaces.

### **2-7.2 Number of Runways.**

Aviation facilities normally have only one runway. Additional runways may be necessary to accommodate operational demands, minimize adverse wind conditions, or overcome environmental impacts. A parallel runway may be provided based on operational requirements. Methodologies for calculating runway capacity in terms of annual service volume (ASV) and hourly IFR or visual flight rules (VFR) capacity are provided in FAA AC 150/5060-5. Planning efforts to analyze the need for more than one runway should be initiated when it is determined that traffic demand for the primary runway will reach 60 percent of its established capacity (FAA guidance). For USAF facilities, also see AFMAN 32-1084, Facility Requirements, Facility Analysis Category (FAC) 1111, Runways.

### **2-7.3 Number of Helipads.**

At times at airfields or heliports, a large number of helicopters are parked on mass aprons or are in the process of takeoff and landing. When this occurs, there is usually a requirement to provide landing and takeoff facilities that permit more rapid launch and recovery operations than can otherwise be provided by a single runway or helipad. This increased efficiency can be obtained by providing one or more of the following options, but is not necessarily limited to:

- Multiple helipads, hoverpoints, or runways
- Rotary-wing runways in excess of 490 m (1600 ft) long
- Landing lane(s)

### **2-7.4 Runway and Helipad Location.**

Runway and helipad location and orientation are paramount to airport safety, efficiency, economics, practicality, and environmental impact. The degree of concern given to each factor influencing runway or helipad location depends greatly on meteorological conditions, adjacent land use and land availability, airspace availability, runway/helipad type/instrumentation, environmental factors, terrain features/topography, and obstructions to air navigation.

#### **2-7.4.1 Obstructions to Air Navigation.**

Runways and helipads must have approaches that are free and clear of obstructions. Runways and helipads must be planned so that the ultimate development of the airfield provides unobstructed navigation. A survey of obstructions will be undertaken to identify those objects that may affect aircraft operations. Protection of airspace can be accomplished through land purchase, easement, zoning coordination, and application of appropriate military directives.

#### **2-7.4.2 Airspace Availability.**

Existing and planned instrument approach and departure procedures, Class D Airspace, and special use airspace and traffic patterns influence airfield layouts and runway and helipad locations. Construction projects for new airfields and heliports or construction projects on existing airfields have the potential to affect airspace. These projects require notification to the FAA to examine feasibility for conformance with and acceptability into the national airspace system.

#### **2-7.4.3 Runway and Helipad Orientation.**

Wind direction and velocity is a major consideration for siting runways and helipads. To be functional, efficient, and safe, a runway or helipad should be oriented in alignment with the prevailing winds, to the greatest extent practical, to provide favorable wind coverage. Wind data, obtained from local sources, for a period of not less than five years, should be used as a basis for developing the wind rose to be shown on the airfield general site plan. Appendix B, Section 4, provides guidance for the research, assessment, and application of wind data.

#### **2-7.5 Runway and Helipad Separation.**

The lateral separation of a runway from a parallel runway, parallel taxiway, or helipad/hoverpoint is based on the type of aircraft the runway serves. Runway and helipad separation criteria are presented in Chapters 3 and 4 of this manual.

#### **2-7.6 Runway Instrumentation.**

Navigational Aids (NAVAIDS) require land areas of specific size, shape, and grade to function properly and remain clear of safety areas.

##### **2-7.6.1 NAVAIDS, Vault, and Buildings.**

NAVAIDS assist the pilot in flight and during landing. The type of air NAVAIDS that are installed at an aviation facility is based on the instrumented runway studies, as previously discussed in 2-4.5. A lighting equipment vault is provided for airfields and heliport facilities with NAVAIDS, and may be required at remote or stand-alone landing sites. A (NAVAID) building will be provided for airfields with NAVAIDS. Each type of NAVAID equipment is usually housed in a separate facility. Technical advice and guidance for air NAVAIDS should be obtained from service-specific support and siting agencies.

## **2-8 AIRCRAFT GROUND MOVEMENT AND PARKING AREAS.**

Aircraft ground movement and parking areas consist of taxiways and aircraft parking aprons.

### **2-8.1 Taxiways.**

Taxiways provide for free ground movement to and from the runways, helipads, and maintenance, cargo/passenger, and other areas of the aviation facility. The objective of taxiway system planning is to create a smooth traffic flow. This system allows unobstructed ground visibility; a minimum number of changes in aircraft taxiing speed; and, ideally, the shortest distance between the runways or helipads and apron areas.

#### **2-8.1.1 Taxiway System.**

The taxiway system is comprised of entrance and exit taxiways; bypass, crossover taxiways; apron taxiways and taxilanes; hangar access taxiways; and partial-parallel, full-parallel, and dual-parallel taxiways. The design and layout dimensions for various taxiways are provided in Chapter 5.

#### **2-8.1.2 Taxiway Capacity.**

At airfields with high levels of activity, the capacity of the taxiway system can become the limiting operational factor. Runway capacity and access efficiency can be enhanced or improved by the installation of parallel taxiways. A full-length parallel taxiway may be provided for a single runway, with appropriate connecting lateral taxiways to permit rapid entrance and exit of traffic between the apron and the runway. At facilities with low air traffic density, a partial parallel taxiway or mid-length exit taxiway may suit local requirements; however, develop plans so that a full parallel taxiway may be constructed in the future when such a taxiway can be justified.

#### **2-8.1.3 Runway Exit Criteria.**

The number, type, and location of exit taxiways is a function of the required runway capacity. Exit taxiways are typically provided at the ends and in the center and midpoint on the runway. Additional locations may be provided as necessary to allow landing aircraft to exit the runway quickly. Chapter 5 provides additional information on exit taxiways.



#### **2-8.1.4 Dual-Use Facility Taxiways.**

For taxiways at airfields supporting both fixed-wing and rotary-wing operations, the appropriate fixed-wing criteria will be applied.

#### **2-8.1.5 Paved Taxiway Shoulders.**

Paved taxiway shoulders are provided to reduce the effects of jet blast on areas adjacent to the taxiway. Paved taxiway shoulders help reduce ingestion of foreign object debris (FOD) into jet intakes. Paved shoulders will be provided on taxiways in accordance with the requirements in Chapter 5.

#### **2-8.2 Aircraft Parking Aprons.**

Aircraft parking aprons are the paved areas required for aircraft parking, loading, unloading, and servicing. They include the necessary maneuvering area for access and exit to parking positions. Aprons will be designed to permit safe and controlled movement of aircraft under their own power. Aircraft apron dimensions and size are based on mission requirements. Additional information concerning Air Force aprons is provided in AFMAN 32-1084, FAC 1131, Aprons. For Navy, see UFC 3-000-05N and paragraph 6-2 APRON REQUIREMENTS for additional guidance.

##### **2-8.2.1 Requirement.**

Aprons are individually designed to support specific aircraft and missions at specific facilities. The size of a parking apron depends on the type and number of aircraft authorized. Chapter 6 provides additional information on apron requirements.

##### **2-8.2.2 Location.**

Aircraft parking aprons typically are located between the parallel taxiway and the hangar line. Apron location with regard to airfield layout will adhere to the operations and safety clearances provided in Chapter 6 of this manual.

##### **2-8.2.3 Capacity.**

Aircraft parking capacity for the Army is discussed in the Facility Planning System (FPS) contained in the Real Property Planning and Analysis System (RPLANS)DAPAM 415-28; in UFC 2-000-05N for the Navy; and in AFMAN 32-1084 for the Air Force.

##### **2-8.2.4 Clearances.**

Lateral clearances for parking aprons are provided from all sides of aprons to fixed and/or mobile objects. Additional information on lateral clearances for aprons is discussed in Chapter 6.

##### **2-8.2.5 Access Taxilanes, Entrances, and Exits.**

The dimensions for access taxilanes on aircraft parking aprons are provided in Chapter 6. The minimum number of exit/entrance taxiways provided for any parking apron should be two.

#### **2-8.2.6 Aircraft Parking Schemes.**

On a typical mass parking apron, aircraft should be parked in rows. The recommended tactical/fighter aircraft parking arrangement is to park aircraft at a 45-degree angle. This is the most economical parking method for achieving the clearance needed to dissipate jet blast temperatures and velocities to levels that will not endanger aircraft or personnel. (For the Navy, these are 38 degrees Celsius (100 degrees Fahrenheit) and 56 km per hour (km/h) (35 miles per hour (mph)) at break-away (intermediate power)). Typical parking arrangements and associated clearances are provided in Chapter 6.

#### **2-8.2.7 Departure Sequencing.**

Aircraft egress patterns from aircraft parking positions to the apron exit taxiways should be considered to prevent congestion at the apron exits. For example, aircraft departing from one row of parking positions should taxi to one exit taxiway, allowing other rows to simultaneously taxi to a different exit.

#### **2-8.2.8 Apron/Other Pavement Types.**

Special use aprons may exist on an aviation facility. Chapter 6 provides further information on these aprons/pavements.

### **2-9 AIRCRAFT MAINTENANCE AREA (OTHER THAN PAVEMENTS).**

An aircraft maintenance area is required when aircraft maintenance must be performed regularly at an aviation facility. Space requirements for maintenance facilities are based on aircraft type.

#### **2-9.1 Aircraft Maintenance Facilities.**

The aircraft maintenance facility includes but is not limited to: aircraft maintenance hangars, special purpose hangars, hangar access aprons, weapons system support shops, aircraft system testing and repair shops, aircraft parts storage, corrosion control facilities, and special purpose maintenance pads. The aircraft maintenance area includes utilities, roadways, fencing, and security facilities and lighting.

#### **2-9.2 Aviation Maintenance Buildings and Hangars.**

For aviation maintenance building information for the Army, see the Facility Planning System (FPS) contained in the Real Property Planning and Analysis System (RPLANS); for the Air Force, see AFMAN 32-1084; for the Navy see UFC 2-000-05N.

#### **2-9.2.1 Maintenance Hangars.**

Maintenance hangars are required to support those aircraft maintenance, repair, and inspection activities that can be more effectively accomplished while the aircraft is under complete cover. The size requirement for maintenance hangars is determined by the number of aircraft assigned. See UFC 4-211-01 for hangars.

#### **2-9.2.2 Security and Storage Hangars.**

These hangars are limited in use and do not require the features normally found in maintenance hangars.

#### **2-9.2.3 Avionics Maintenance Shop.**

Avionics maintenance space should normally be provided within the maintenance hangar; however, a separate building for consolidated avionics repair may be provided at aviation facilities with multiple units.

#### **2-9.2.4 Engine Repair and Engine Test Facilities.**

Engine repair and test facilities are provided at air bases with aircraft engine removal, repair, and testing requirements. Siting of engine test facilities will consider the impacts of jet blast, jet blast protection, and noise suppression.

#### **2-9.2.5 Parts Storage.**

Covered storage of aircraft parts should be provided at all aviation facilities and located close enough to the maintenance area to allow easy access to end users.

#### **2-9.3 Maintenance Aprons.**

These aprons should be sized according to the dimensions discussed in Chapter 6.

#### **2-9.4 Apron Lighting.**

Apron area lighting (floodlights) is provided where aircraft movement, loading or unloading, and security are required at night, and during poor visibility. The type of lighting is based on the amount of apron space or number of aircraft positions that receive active use during nighttime operations.

#### **2-9.5 Security.**

The hangar line typically represents the boundary of the airfield operations area. Maintenance buildings should be closely collocated to discourage unauthorized access and enhance facility security.

### **2-10 AVIATION OPERATIONS SUPPORT AREA.**

#### **2-10.1 Aviation Operations Support Facilities.**

Aviation operations support facilities include those facilities that directly support the flying mission. Operations support includes air traffic control, aircraft rescue and firefighting, fueling facilities, the airfield operations center (airfield management facility), squadron operations/aircraft maintenance units, and air mobility operations groups.

#### **2-10.2 Location.**

Aviation operations support facilities should be located along the hangar line, with the central area typically being allocated to airfield operations (airfield management facility), air traffic control, aircraft rescue and firefighting, and flight simulation. Aircraft maintenance facilities should be located on one side of the runway to allow simplified access among maintenance areas, aircraft, and support areas.

#### **2-10.3 Orientation of Facilities.**

Facilities located either parallel or perpendicular to the runway make the most efficient use of space. Diagonal and curved areas tend to divide the area and result in awkward or unusable spaces.

#### **2-10.4 Multiple Supporting Facilities.**

When multiple aviation units are located at one facility, their integrity may be retained by locating such units adjacent to each other.

#### **2-10.5 Transient Facilities.**

Provisions should be made for transient and very important person (VIP) aprons and buildings. These facilities should be located near the supporting facilities discussed in paragraph 2-10.1.

#### **2-10.6 Other Support Facilities.**

When required, other support facilities, such as aviation fuel storage and dispensing, heating plants, water storage, consolidated parts storage, and motor pool facilities, should be sited on the far side of an access road paralleling the hangar line.

##### **2-10.6.1 Air Traffic Control Facilities.**

The siting and height of the Air Traffic Control Tower (ATCT) are determined in accordance with Appendix B, Section 16. For Army and Air Force, other air traffic control facilities will be sited in accordance with Appendix B, Section 13. For Navy, other air traffic control facilities will be sited in compliance with surfaces described in Chapters 3 and 4.

##### **2-10.6.2 Radar Approach Control Facilities.**

Some airfields are equipped with radar capability. When the functional proponent determines the need for radar capability, space for radar equipment will be provided.

Space for radar equipment should be provided in the air traffic control tower building and/or RAPCON. See UFC 4-133-01, Air Traffic Control and Air Operations Facilities for facility design requirements.

### **2-10.6.3 Aircraft Rescue and Fire Facilities.**

Airfield facilities and flight operations will be supported by fire and rescue equipment. The aircraft rescue and fire facilities must be located strategically to allow aircraft firefighting vehicles to meet response time requirements to all areas of the airfield. Coordinate the airfield fire and rescue facility and special rescue equipment with the facility protection mission and master plan. It may be economically sound to develop a consolidated or expanded facility to support both airside and landside facilities. The site of the fire and rescue station must permit ready access of equipment to the aircraft operational areas and the road system serving the airfield facilities. A site centrally located, close to the midpoint of the runway, and near the Airfield Operations Building (AOB) and the ATCT is preferred.

### **2-10.6.4 Rescue and Ambulance Helicopters.**

With the increasing use of helicopters for emergency rescue and air ambulance service, consider providing an alert helicopter parking space near the fire and rescue station. This space may be located as part of the fire and rescue station or in a designated area on an adjacent aircraft parking apron.

### **2-10.6.5 Hospital Helipad.**

A helipad should normally be sited in close proximity to each hospital to permit helicopter access for emergency use. Subject to necessary flight clearances and other hospital site factors, the hospital helipad should permit reasonably direct access to and from the hospital emergency entrance.

### **2-10.6.6 Miscellaneous Buildings.**

These buildings should be provided as part of an aviation facility:

- Airfield operations building (airfield management facility)
- Aviation unit operations building (Army); squadron operations building (Air Force)
- Representative weather observation stations (RWOS)
- Authorization and space allowances should be determined in accordance with directives for each Service.

### **2-10.7 Aircraft Fuel Storage and Dispensing.**

#### **2-10.7.1 Location.**

Aircraft fuel storage and dispensing facilities will be provided at all aviation facilities. Operating fuel storage tanks will be provided wherever dispensing facilities are remote from bulk storage. Bulk fuel storage areas require locations that are accessible by tanker truck, tanker rail car, or by waterfront. Both bulk storage and operating storage areas must provide for the loading and parking of fuel vehicles to service aircraft. Where hydrant fueling systems are authorized, bulk fuel storage locations must take into account systems design requirements (e.g., the distance from the fueling apron to the storage tanks).

### **2-10.7.2 Safety.**

Fuel storage and operating areas have requirements for minimum clearances from buildings, aircraft parking, roadways, radar, and other structures/areas, as established in Service directives. Aviation fuel storage and operating areas also require lighting, fencing, and security alarms. All liquid fuel storage facility sitings must address spill containment and leak protection/detection.

## **2-10.8 Service Roadways to Support Airfield Activities.**

### **2-10.8.1 General.**

Uncontrolled vehicle roads will not be planned to violate airfield imaginary surfaces and safety clearance distances. Roads should be located so that surface vehicles will not be hazards to air navigation and air navigation equipment. All roads within the movement area will be controlled by the ATCT. See Appendix B, Section 13, Para B13-2.20.2.9.

### **2-10.8.2 Rescue and Firefighting Roadways.**

Rescue and firefighting access roads are usually needed to provide unimpeded two-way access for rescue and firefighting equipment to potential accident areas. Connecting these access roads to the extent practical with airfield operational surfaces and other airfield roads will enhance fire and rescue operations. Dedicated rescue and firefighting access roads are all-weather roads designed to support vehicles traveling at normal response speeds.

### **2-10.8.3 Fuel Truck Access.**

Fuel truck access points to aircraft parking aprons should be located to provide minimal disruptions and hazards to active aircraft operating areas. Fuel truck access from the facility boundary to the fuel storage areas should be separate from other vehicular traffic. Fuel trucks should be parked as close to the flight line as is reasonably possible.

### **2-10.8.4 Explosives and Munitions Transfer to Arm/Disarm Pads.**

Transfer of explosives and munitions from storage areas to arm/disarm pads should occur on dedicated transfer roads. Transfer roads should be used exclusively for explosives and munitions transfer vehicles.

## **2-11 NAVY/MARINE CORPS EXCEPTIONS FROM CRITERIA NOT REQUIRING NAVFAC DESIGN WAIVERS/EXEMPTIONS FROM UFC 3-260-01 OR NAVAIR AIRFIELD SAFETY WAIVERS.**

Siting and design for airfield facilities and equipment must conform to appropriate design and siting criteria, and must be necessary for support of assigned mission aircraft, or multiple waivers (design and safety) may be required. (See Appendix B, Section 1, Para B1-3 for waiver types and procedures.) If the equipment renders satisfactory service at locations that do not penetrate airfield safety surfaces, such locations should be selected to enhance the overall efficiency and safety of airfield operations. This section lists certain airfield facilities that are considered exceptions to certain criteria (such as violating safety surfaces) only if they are sited in those zones in accordance with guidance in this UFC. This is due to their nature of inherently needing to be locating within certain zones for functional reasons that may create a criteria conflict. Even so, siting guidance in this UFC for these facilities must be satisfied or a design or safety waiver is still required. All structures placed or constructed within the airfield environment must be made frangible (to the maximum extent practicable) or placed below grade. Consult NAVAIR for Airfield Safety Waiver requirements for airfield facilities and equipment that are not specifically listed in this section. THE FOLLOWING FACILITIES DO NOT REQUIRE AN AIRFIELD SAFETY WAIVER or NAVFAC DESIGN WAIVER IF SITED IN ACCORDANCE WITH THIS UFC WHERE GUIDANCE IS PROVIDED:

### **2-11.1 Visual Air Navigational Facilities.**

This term identifies, as a type of facility, all lights, signs and other devices located on, and in the vicinity of, an airfield that provide a visual reference to pilots for guidance when operating aircraft in the air and on the ground. Examples of visual air navigation facilities are Precision Approach Path Indicator (PAPI), Visual Slope Indicator (VASI), Optical Lighting Systems (OLS), runway distance remaining (RDR) signs, taxiway guidance and orientation signs, beacons, approach lighting, wind direction indicators, obstruction lights, and electric transformers in support of airfield lighting. For detailed construction and siting criteria, see UFC 3-535-01.

### **2-11.2 Radar/Communications Facilities.**

When properly sited by Space and Naval Warfare Systems Center (SPAWARS) the exempted systems include Fixed Base Airport Surveillance Radar (ASR), Fixed Base Digital Airport Surveillance Radar (DASR), Tactical Air Navigation System (TACAN), Precision Approach Radar (PAR), Instrument Landing System (ILS), radar reflectors, and VHF/UHF radio facility (transmitter receiver site may include shelter), expeditionary equipment (TACAN, ASR, PAR) temporarily located for an event.

### **2-11.3 Other Facilities and Equipment.**

Other facilities that are excepted from waiver requirements include Arm-Dearm Pads, Automated Surface Observing System (ASOS), Portable Landing Signal Officer (LSO),

and Runway Duty Officer (RDO) facilities positioned on the primary surface during an event and permanent LSO facilities positioned adjacent to dedicated simulated Landing, Helicopter, Assault (LHA)/Landing, Helicopter, Deck (LHD) facility, Concrete bollards positioned to protect fire hydrants and extinguishers if located on the aircraft parking apron and next to the hangar. Airfield service roads located for access to NAVAIDs, aircraft arresting systems, weather sensors, and other similar areas on the airfield. Signage and traffic signals associated with the airfield service roads.

## **2-12 AIRFIELD UTILITY STRUCTURES.**

All buried utility structures (manholes, handholes, drainage structures, etc.) constructed within runways, taxiways, towways, helipads, aprons, overruns or shoulders (paved or unpaved) will, at a minimum, be designed as provided in the following paragraphs. Regardless of location on the airfield, the top surface of foundations, manhole covers, handhole covers, and frames will be flush with the grade. Maintenance action is required if the drop-off at any edge of the structure exceeds 76 mm (3 in).

### **2-12.1 Load Bearing Pavements and Paved Shoulder Areas.**

- For manhole covers and inlet grates and frames, design for a 45,000 kg (100,000 lb) wheel load with 1.72 MPa (250 psi) tire pressure. Higher tire pressures should be assumed if the using aircraft will have tire pressure greater than 1.72 MPa (250 psi).
- For structures with their shortest span equal to or less than 0.6 m (2 ft), design based on a single wheel load of 45,000 kg (100,000 lb) at a contact pressure of 1.72 MPa (250 psi), or a uniform live load over the entire structure of 1.72 MPa (250 psi), whichever is greater.
- For structures with their shortest span greater than 0.6 m (2 ft), design based on the maximum number of wheels that can fit onto the span, considering the most critical assigned aircraft operating at its maximum gross weight. In no case, however, should the design be based on computed stress conditions less than those created by a wheel load of 45,000 kg (100,000 lb) at a contact pressure of 1.72 MPa (250 psi).

### **2-12.2 Unpaved Shoulder Areas.**

- For manhole covers and inlet grates and frames, design for a 45,000 kg (100,000 lb) wheel load with 1.72 MPa (250 psi) tire pressure. Higher tire pressures should be assumed if the using aircraft will have tire pressure greater than 1.72 MPa (250 psi).
- For structures with their shortest span equal to or less than 0.6 m (2 ft), design based on a single wheel load of 22,667 kg (50,000 lb) at a contact pressure of 1.72 MPa (250 psi), or a uniform live load over the entire structure of 1.72 MPa (250 psi), whichever is greater.



- For structures with their shortest span greater than 0.6 m (2 ft), design based on the maximum number of wheels that can fit onto the span, considering the most critical assigned aircraft operating at its maximum gross weight. In no case, however, should the design be based on computed stress conditions less than those created by a wheel load of 22,667 kg (50,000 lb) at a contact pressure of 1.72 MPa (250 psi).

**2-12.3 Other Airfield Areas.**

- Beyond the paved or unpaved shoulder areas of runways, taxiways, towways, helipads, aprons or overruns, underground structures are not designed to support aircraft wheel loads; however, they will be designed to support standard truck loads (AASHTO H20/HS20).

CANCELLED

THIS PAGE INTENTIONALLY BLANK

CANCELLED

## CHAPTER 3 RUNWAYS (FIXED-WING) AND IMAGINARY SURFACES

### 3-1 CONTENTS.

This chapter presents design standards and considerations for fixed-wing runways and associated imaginary surfaces.

### 3-2 REQUIREMENTS.

The landing and takeoff design considerations for an airfield include mission requirements, expected type and volume of air traffic, traffic patterns such as the arrangement of multidirectional approaches and takeoffs, ultimate runway length, runway orientation required by local wind conditions, local terrain, restrictions due to airspace obstacles or the surrounding community, noise impact, and aircraft accident potential. When planning to construct a new runway or to lengthen an existing runway, in addition to local permitting requirements, file FAA Form 7480-1 in accordance with FAA Order 7400.2.

### 3-3 RUNWAY CLASSIFICATION.

Runways are classified as either Class A or Class B based on aircraft type as shown in Table 3-1. This table uses the same runway classification system established by the Office of the Secretary of Defense as a means of defining accident potential areas (zones) for the AICUZ program. These runway classes are not to be confused with aircraft approach categories and aircraft wingspan in other DoD or FAA documents, aircraft weight classifications, or pavement traffic areas. The aircraft listed in Table 3-1 are examples of aircraft that fall into these classifications and may not be all-inclusive.

#### 3-3.1 Class A Runways.

Class A runways are primarily intended for small, light aircraft. These runways do not have the potential or foreseeable requirement for development for use by high-performance and large, heavy aircraft. Ordinarily, these runways are less than 2,440 m (8,000 ft) long and less than 10% of their operations involve aircraft in the Class B category; however, this is not intended to limit the number of C-130 and C-17 operations conducted on any Class A airfield.

#### 3-3.2 Class B Runways.

Class B runways are primarily intended for high-performance and large, heavy aircraft, as shown in Table 3-1. For airfield safety clearances applicable to USAF missions on US Army airfields, see paragraph 2-5.4.2.

#### 3-3.3 Special Tilt-Rotor Aircraft Considerations (V-22).

The V-22 is a tilt-rotor aircraft that can operate both as a fixed-wing aircraft or a rotary-wing aircraft. When the V-22 operates on a fixed-wing airfield, this chapter applies with

noted V-22 exceptions. See paragraph 1.2.2.4 for general V-22 planning considerations.

**Table 3-1. Runway Classification by Aircraft Type**

Runway Classification by Aircraft Type				
Class A Runways		Class B Runways		
C-1	OV-10	A-4		P-3
C-2	T-3	A-6	E-3	P-8
C-12	T-6 (Navy)	EA-6B	E-4	RQ-4
C-20	T-28	A-10	E-6	RQ-9
C-21	T-34	AV-8	E-8	MQ-4
C-22	T-41	B-1	EA-18	S-3
C-23	T-44	B-2	R/F-4	T-1
C-26	U-21	B-52	F-5	T-2
C-37	UC-35	C-5	F-15	T-6 (Air Force)
C-38	UV-18	C-9	F-16	T-38
E-1	V-22	KC-10	E/F/A-18	T-43
E-2	DASH-7	KC-135	F-22	T-45
MQ-1	DASH-8	KC-46	F-35	TR-1
		C-17		U-2
		C-27J		VC-25
		C-32		
		C-40		
		C-130		
		C-135		
		C-137		

**NOTES:**

1. Only symbols for basic mission aircraft or basic mission aircraft plus type are used. Designations represent entire series. Runway classes in this table are not related to aircraft approach categories, aircraft weight, aircraft wingspan, or to pavement design classes or types.
2. These are examples of aircraft that fall into these classifications, and may not be all-inclusive.
3. Rotary aircraft are not addressed in this table.
4. For F-35B aircraft operating as STOVL, see Chapter 8.
5. For US Army rotary-wing aircraft, see Chapter 4.

**3-3.4 Landing Zones (formerly called Short Fields and Training Assault Landing Zones).**

Landing zones are special use fields. Design criteria for these airfields are provided in Chapter 7 of this manual.

**3-4 RUNWAY SYSTEMS.**

**3-4.1 Single Runway.**

A single runway is the least flexible and lowest capacity system. The capacity of a single runway system will vary from approximately 40 to 50 operations per hour under IFR conditions and up to 75 operations per hour under VFR conditions.

### 3-4.2 Parallel Runways.

Parallel runways are the most commonly used system for increased capacity. In some cases, parallel runways may be staggered, with the runway ends offset from each other and with terminal or service facilities located between the runways. When parallel runways are separated by less than the IFR separation distance shown in Item 15 of Table 3-2, the second runway will increase capacity at the airfield under VFR conditions, but due to the close distance, capacity at the airfield will not be increased under IFR conditions.

### 3-4.3 Crosswind Runways.

Crosswind runways may be either the open-V or the intersecting type of runway. The crosswind system is adaptable to a wider variety of wind conditions than the parallel system. When winds are calm, both runways may be used simultaneously. An open-V system has a greater capacity than an intersecting system.

**Table 3-2. Runways**

Table 3-2. Runways				
Item		Class A Runway	Class B Runway	Remarks
No.	Description	Requirement		
1	Length	See Table 3-3	See Remarks	For Army airfields. For Army Class B runways, runway length will be determined by the ACOMs/ASCCs/DRUs/or ARNG in conjunction with HQDA, G4 by identifying the most critical aircraft in support of USTRANSCOM global transportation requirements.
		See Remarks	See Remarks	For Air Force airfields, runway length will be determined by the MAJCOM/A3 for the most critical aircraft to be supported
		See Remarks	See Remarks	For Navy and Marine Corps airfields, see UFC 2-000-05N for computation of runway lengths.
2	Width	30 m (100 ft)	46 m (150 ft)	Army airfields and Air Force airfields, not otherwise specified.
		N/A	90 m (300 ft)	B-52 aircraft. AFI 11-202 V3 allows that B-52 aircraft may routinely operate on 60 m (200 ft) wide runways.
		23 m (75 ft)	60 m (200 ft)	Navy and Marine Corps airfields. Runway width for T-34 and T-44 will be 45 m (150 ft).
3		15 m (50 ft)	60 m (200 ft)	Army and Air Force airfields

Table 3-2. Runways				
Item		Class A Runway	Class B Runway	Remarks
No.	Description	Requirement		
	Total width of shoulder (paved and unpaved)	7.5 m (25 ft)	46 m (150 ft)	Navy and Marine Corps airfields
4	Paved shoulder width	7.5 m (25 ft)	7.5 m (25 ft)	Army and Air Force Manned Aircraft with exception for Trainer, Fighter and B-52 aircraft indicated below. For Air Force, pave shoulders to provide a combined hard surface width (runway and paved shoulders) of not less than 60 m (200 feet) with at least 0.6 m (2 ft) of paved surface beyond the edge lights.
		N/A	3 m (10 ft)	Air Force airfields designed for Trainer, Fighter and B-52 aircraft. (Pave shoulders to provide a combined hard surface width (runway and paved shoulders) of 52 m (170 feet) for fighters and trainers and 98 m (320 feet) for B-52 mission runways, with at least 0.6 m (2 ft) of paved surface beyond the edge lights.
		3 m (10 ft)	3 m (10 ft)	Navy and Marine Corps airfields
5	Longitudinal grades of runway and shoulders	Maximum 1.0%		<p>Grades may be both positive and negative but must not exceed the limit specified. Grade restrictions are exclusive of other pavements and shoulders. Where other pavements tie into runways, comply with grading requirements for towways, taxiways, or aprons as applicable, but hold grade changes to the minimum practicable to facilitate drainage.</p> <p>Exception for shoulders (paved and unpaved): a 3.33% maximum is permitted where arresting systems and visual glide slope indicators (VGSIs) are installed relative to the longitudinal slope of the runway and shoulders. Grade deviations must be held to a minimum for VGSI installations but may be used when necessary to limit the overall height of the light housings above grade.</p>
6	Longitudinal runway grade changes	No grade change is to occur less than 300 m (1,000 ft) from	No grade change is to occur less than 900 m (3,000 ft) from	Where economically feasible, the runway will have a constant centerline gradient from end to end. Where terrain dictates the need for centerline grade changes, the distance between two successive point of

Table 3-2. Runways				
Item		Class A Runway	Class B Runway	Remarks
No.	Description	Requirement		
		the runway end	the runway end	intersection (PI) will be not less than 300 m (1,000 ft) and two successive distances between PIs will not be the same.
7	Rate of longitudinal runway grade changes	Max 0.167% per 30 linear meters (100 linear feet) of runway		Army and Air Force Maximum rate of longitudinal grade change is produced by vertical curves having 180-m (600-ft) lengths for each % of algebraic difference between the two grades.
		Max 0.10% per 30 linear meters (100 linear feet) of runway		Navy and Marine Corps Maximum rate of longitudinal grade change is produced by vertical curves having 300-m (1,000-ft) lengths for each % of algebraic difference between the two grades.
		See Remarks		Exceptions: 0.4% per 30 linear meters (100 ft) for edge of runways at runway intersections
8	Longitudinal sight distance	Min 1,500 m (5,000 ft)		Any two points 2.4 m (8 ft) above the pavement must be mutually visible (visible by each other) for the distance indicated.  For runways shorter than 1,500 m (5,000 ft), height above runway will be reduced proportionally.
9	Transverse grade of runway	Min 1.0% Max 1.5%		New runway pavements will be centerline crowned. Existing runway pavements with insufficient transverse gradients for rapid drainage should provide increasing gradients when overlaid or reconstructed.
				Slope pavement downwards from centerline of runway.  1.5% slope is optimum transverse grade of runway.  Selected transverse grade is to remain constant for length and width of runway, except at or adjacent to runway intersections where pavement surfaces must be warped to match abutting pavements. For Navy and Marine Corps, this exception also applies to aircraft arresting system cables where the transverse slope may be reduced to 0.75% in the center section to allow achieving the

Table 3-2. Runways				
Item		Class A Runway	Class B Runway	Remarks
No.	Description	Requirement		
				proper pendant height above the runway crown. See paragraph 3-17.2.2 for modifications to transverse grade in the area of the aircraft arresting system pendant.
10	Transverse grade of paved shoulder	2% min 3% max		<p>Paved portion of shoulder.</p> <p>Slope downward from runway pavement. Reversals are not allowed.</p> <p>Exception allowed in the tape sweep area for USAF aircraft arresting systems. At runway edge sheaves, paved shoulder slope should match runway cross slope on centerline crowned runways. Designers will warp the adjacent tape sweep area pavement surfaces to direct drainage away from the aircraft arresting system components as much as possible.</p> <p>Pavement within the tape sweep area of arresting systems will meet the design and grade criteria in USAF Typical Installation Drawing 67F2013A.</p>
11	Transverse grade of unpaved shoulder	(a) 40-mm (1.5-in) drop-off at edge of paved shoulder, +/- 13 mm (0.5 in) (b) 2% min, 4% max.		<p>Unpaved portion of shoulder</p> <p>Slope downward from shoulder pavement.</p> <p>For additional information, see Figure 3-1. Reversals not allowed.</p>
12	Runway lateral clearance zone	152.40 m (500 ft)	152.40 m (500 ft)	Army airfields
		152.40 m (500 ft)	304.80 m (1,000 ft)	Air Force, Navy, and Marine Corps
		152.4 m (500 ft)	228.6 m (750 ft)	Navy airfields constructed prior to 1981.
		<p>(1) The runway lateral clearance zone's lateral limits coincide with the limits of the primary surface. The ends of the lateral clearance zone coincide with the runway ends. The ground surface within this area must be clear of fixed or mobile objects as defined in the glossary, and graded to the requirements of Table 3-2, items 13 and 14. The zone distance is measured perpendicularly each direction from the centerline of the runway and begins at the runway centerline. See Table 3-7 for other height restrictions and controls.</p> <p>(2) Fixed obstacles are those defined in the glossary. Navigational aids and meteorological equipment may be sited within these clearances where essential for their proper functioning. For Army and Air Force, this area to be clear of all obstacles except for properly sited permissible deviations</p>		



Table 3-2. Runways				
Item		Class A Runway	Class B Runway	Remarks
No.	Description	Requirement		
		<p>noted in Appendix B, Section 13. For Navy and Marine Corps, certain items that are listed in Appendix B, Section 1, Paragraph B1-3.4 are exempted.</p> <p>(3) Mobile obstacles are those defined in the glossary. Taxiing aircraft, emergency vehicles, and authorized maintenance vehicles are exempt from this restriction.</p> <p>(4) For Army and Air Force airfields, parallel taxiway (exclusive of shoulder width) will be located in excess of the lateral clearance distances (primary surface). For Navy and Marine Corps airfields, the centerline of a runway and a parallel taxiway will be a minimum of 152.4 m (500 ft) apart. For Class A Airfields, one half of the parallel taxiway may be located within the runway lateral clearance zone.</p> <p>(5) For Class A runways, except at Navy and Marine Corps airfields, above ground drainage structures, including headwall, are not permitted within 91.26 m (300 ft) of the runway centerline. For Class B runways, except at Navy and Marine Corps airfields, above ground drainage structures, including headwalls are not permitted within 114.3 m (375 ft) of the runway centerline. At Navy and Marine Corps airfields, above ground drainage structures will be individually reviewed. Drainage slopes of up to a 10 to 1 ratio are permitted for all runway classes, but swales with more gentle slopes are preferred.</p> <p>(6) Distance from runway centerline to helpads is discussed in Table 4-1.</p> <p>(7) For Military installations overseas (other than bases located in the United States, its territories, trusts, and possessions), apply to the maximum practical extent.</p>		
13	Longitudinal grades within runway lateral clearance zone	Max 10.0%		<p>Exclusive of pavement, shoulders, and cover over drainage structures.</p> <p>Slopes are to be as gradual as practicable. Avoid abrupt changes or sudden reversals. Rough grade to the extent necessary to minimize damage to aircraft.</p>
14	Transverse grades within runway lateral clearance zone (in direction of surface drainage)	<p>Min of 2.0% to Max 10.0%<sup>4</sup></p> <p>Grades may be upwards or downwards</p>		<p>Exclusive of pavement, shoulders, and cover over drainage structures.</p> <p>Slopes are to be as gradual as practicable. Avoid abrupt changes or sudden reversals. Rough grade to the extent necessary to minimize damage to aircraft.</p>
15	Distance between centerlines of parallel runways	213.36 m (700 ft)	304.80 m (1,000 ft)	VFR without intervening parallel taxiway between the parallel runways. One of the parallel runways must be a VFR only runway.
		632.46 m (2,075 ft)		VFR with intervening parallel taxiway.

Table 3-2. Runways				
Item		Class A Runway	Class B Runway	Remarks
No.	Description	Requirement		
		762.00 m (2,500 ft)		IFR using simultaneous operation (depart-depart) (depart-arrival)
		1,310.64 m (4,300 ft)		IFR using simultaneous approaches
				For separation distance between fixed-wing runways and rotary-wing facilities, see Table 4-1.
16	Width of USAF and Army mandatory frangibility zone (MFZ)	152.4 m (500 ft)		Centered on the runway centerline. All items sited within this area must be frangible (see Appendix B, Section 13).
17	Length of USAF and Army MFZ	Runway length plus 914.4 m (3,000 ft) at each end		Centered on the runway. All items sited within this area to the ends of the graded area of the clear zone must be frangible (also see Table 3-5 and Appendix B, Section 13). Items located beyond the graded area of the clear zone must be constructed to be frangible, low impact resistant structures, or semi-frangible (see Appendix B, Section 13).

**NOTES:**

1. Geometric design criteria in this manual are based on aircraft-specific requirements and are not direct conversions from inch-pound (English) dimensions.
2. Airfield and heliport imaginary surfaces and safe wingtip clearance dimensions are direct conversions from inch-pound to SI units.
3. English dimensions apply to new airfield construction at US facilities. Metric units apply to airfield construction where necessary for host nation construction practices.
4. Bed of channel may be flat. When drainage channels are required, the channel bottom cross section may be flat but the channel must be sloped to drain

### **3-5 RUNWAY ORIENTATION/WIND DATA.**

Runway orientation is the key to a safe, efficient, and usable aviation facility. Orientation is based on an analysis of wind data, terrain, local development, operational procedures, and other pertinent data. Procedures for analysis of wind data to determine runway orientation are discussed further in Appendix B, Section 4.

### **3-6 ADDITIONAL CONSIDERATIONS FOR RUNWAY ORIENTATION.**

In addition to meteorological and wind conditions, the factors in paragraphs 3-6.1 through 3-6.7 must be considered.

#### **3-6.1 Obstructions.**

A specific airfield site and the proposed runway orientation must be known before a detailed survey can be made of obstructions that affect aircraft operations. Runways should be so oriented that approaches necessary for the ultimate development of the airfield are free of all obstructions.

#### **3-6.2 Restricted Airspace.**

Airspace through which aircraft operations are restricted, and possibly prohibited, is shown on sectional and local aeronautical charts. Runways should be so oriented that their approach and departure patterns do not encroach on restricted areas.

#### **3-6.3 Built-Up Areas.**

Airfield sites and runway alignment will be selected and operational procedures adopted that will least impact local inhabitants. Additional guidance for facilities is found in DoDI 4165.57.

#### **3-6.4 Neighboring Airports.**

Existing aircraft traffic patterns of airfields in the area may affect runway alignment.

#### **3-6.5 Topography.**

Avoid sites that require excessive cuts and fills. Evaluate the effects of topographical features on airspace zones, grading, drainage, and possible future runway extensions.

#### **3-6.6 Soil Conditions.**

Evaluate soil conditions at potential sites to minimize settlement problems, heaving from highly expansive soils, high groundwater problems, and construction costs. Evaluate the project area for wetlands and potential historical/archeological sites. Analyze the soil for contaminants and plan for remediation or protection, as necessary.

#### **3-6.7 Noise Analysis.**

Noise analyses will be conducted to determine noise impacts to on-base and local communities and to identify noise-sensitive areas.

### **3-7 RUNWAY DESIGNATION.**

Runways are identified by the whole number nearest one-tenth (1/10) the magnetic azimuth of the runway centerline. The magnetic azimuth of the runway centerline is measured clockwise from magnetic north when viewed from the direction of approach. For example, where the magnetic azimuth is 183 degrees, the runway designation marking would be 18; and for a magnetic azimuth of 117 degrees, the runway designation marking would be 12. For a magnetic azimuth ending in the number 5, such as 185 degrees, the runway designation marking can be either 18 or 19. Supplemental letters, where required for differentiation of parallel runways, are placed between the designation numbers and the threshold or threshold marking. For parallel runways, the supplemental letter is based on the runway location, left to right, when viewed from the direction of approach: for two parallel runways—"L," "R"; for three parallel runways—"L," "C," "R." A zero (0) is marked to precede single-digit numbers on Class B runways except those subject to NAVAIR 51-50AAA-2.

### **3-8 RUNWAY DIMENSIONS.**

The paragraphs, tables, and figures in this section present the design criteria for runway dimensions at all aviation facilities except landing zones. The criteria presented in the figures are for all DoD components (Army, Air Force, Navy, and Marine Corps), except where deviations are noted.

#### **3-8.1 Runway Dimension Criteria, Except Runway Length.**

Table 3-2 presents all dimensional criteria, except runway length, for the layout and design of runways used primarily to support fixed-wing aircraft operations.

#### **3-8.2 Runway Length Criteria.**

##### **3-8.2.1 Army.**

For Army Class A runways, the runway length will be determined in accordance with Table 3-3. Army Class B runways are used to support USTRANSCOM global transportation requirements; therefore, runway length will be determined by the ACOMs/ASCCs/DRUs/or ARNG in conjunction with HQDA, G4 by identifying the most critical aircraft in support of USTRANSCOM requirements.

##### **3-8.2.2 Air Force.**

For Air Force Class A and Class B runways, the length will be determined by the MAJCOM.

##### **3-8.2.3 Navy and Marine Corps.**

Runway length computation for Navy and Marine Corps Class A and Class B runways is presented in UFC 2-000-05N.

**3-8.3 Layout.**

Typical sections and profiles for Army, Air Force, Navy, and Marine Corps airfield runways and the associated airspace surfaces are shown in Figures 3-1 through 3-22.

**Table 3-3. Army Class A Runway Lengths**

Temperature	Elevation				
	Sea Level	304 meters (1,000 feet)	610 meters (2,000 feet)	1,524 meters (5,000 feet)	1,828 meters (6,000 feet)
15°C (60°F)	1,615 m (5,300 ft)	1,676 m (5,500 ft)	1,768 m (5,800 ft)	2,042 m (6,700 ft)	2,164 m (7,100 ft)
30°C (85°F)	1,707 m (5,600 ft)	1,798 m (5,900 ft)	1,890 m (6,200 ft)	2,286 m (7,500 ft)	2,438 m (8,000 ft)
40°C (105°F)	1,798 m (5,900 ft)	1,890 m (6,200 ft)	2,042 m (6,700 ft)	2,469 m (8,100 ft)	2,682 m (8,800 ft)

NOTES:

1. Based on zero runway gradient and a clean, dry runway surface for the most critical aircraft in the Army's inventory to date (RC-12N).

**3-9 RUNWAY END SITING REQUIREMENTS.**

This paragraph provides guidance on the preliminary design for the establishment of runway thresholds and departure ends. Final design must be based on a detailed analysis and coordination with each service Flight Standards Agency and verified with Terminal Instrument Procedures (TERPS).

**3-9.1 Runway Ends.**

The runway ends are the physical ends of the rectangular surface that constitutes a runway. The end of the runway is normally the beginning of the takeoff roll and the end of the landing roll out.

**3-9.2 Threshold.**

The threshold is ideally located at the beginning of the runway. The threshold is located to provide proper clearance for landing aircraft over existing obstacles while on approach to landing. When an object is beyond the DoD's ability to remove, relocate, or reduce the height and the object obstructs the airspace required for aircraft to land at the beginning of the runway for takeoff, the threshold may be located farther down the runway. Such a threshold is called a "displaced threshold."

### **3-9.2.1 Displaced Threshold.**

A displaced threshold may be designated on certain runways in order to avoid obstacles in the imaginary or TERPS surfaces. When it is determined that a runway requires a displaced threshold, the responsible airfield authority will evaluate each individual situation and set the displaced threshold and airspace imaginary surfaces.

### **3-9.2.2 Impacts to Runway Length.**

Displacement of a threshold reduces the length of runway available for landings. The portion of the runway behind a displaced threshold may be available for takeoffs and, depending on the reason for displacement, may be available for takeoffs and landings from the opposite direction.

### **3-9.2.3 Other Impacts.**

Displacement of the threshold often introduces disruptions to an otherwise orderly airport design. Approach lighting systems and NAVAIDs used for landing may need to be moved. Taxiways that remain in the new approach area (prior to the threshold) can create situations where taxiing aircraft penetrate the approach surface or the Clear Zone. Hold lines may also need to be moved to keep aircraft clear of these areas and runway capacity may be affected. While threshold displacement is often used to as a solution for constrained airspace, airfield designers need to carefully weigh the trade-offs of a displaced threshold. Displacing a threshold may also create a situation where the holdline must be placed on the parallel taxiway. This is undesirable as pilots do not normally expect to encounter a holdline on the parallel taxiway.

### **3-9.2.4 Cautions.**

Threshold displacement should be undertaken only after full evaluation reveals that displacement is the best alternative. Coordination must be made with each Service Flight Standards Agency, TERPS, Engineering, and Operations.

Figure 3-1. Runway Transverse Sections and Primary Surface

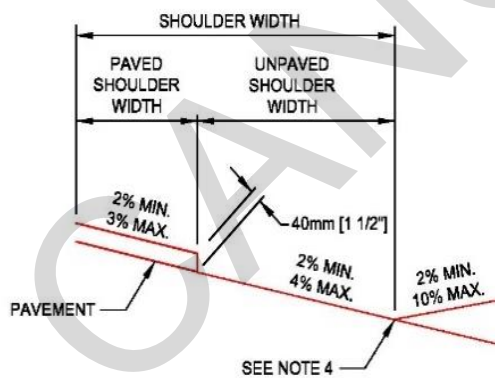
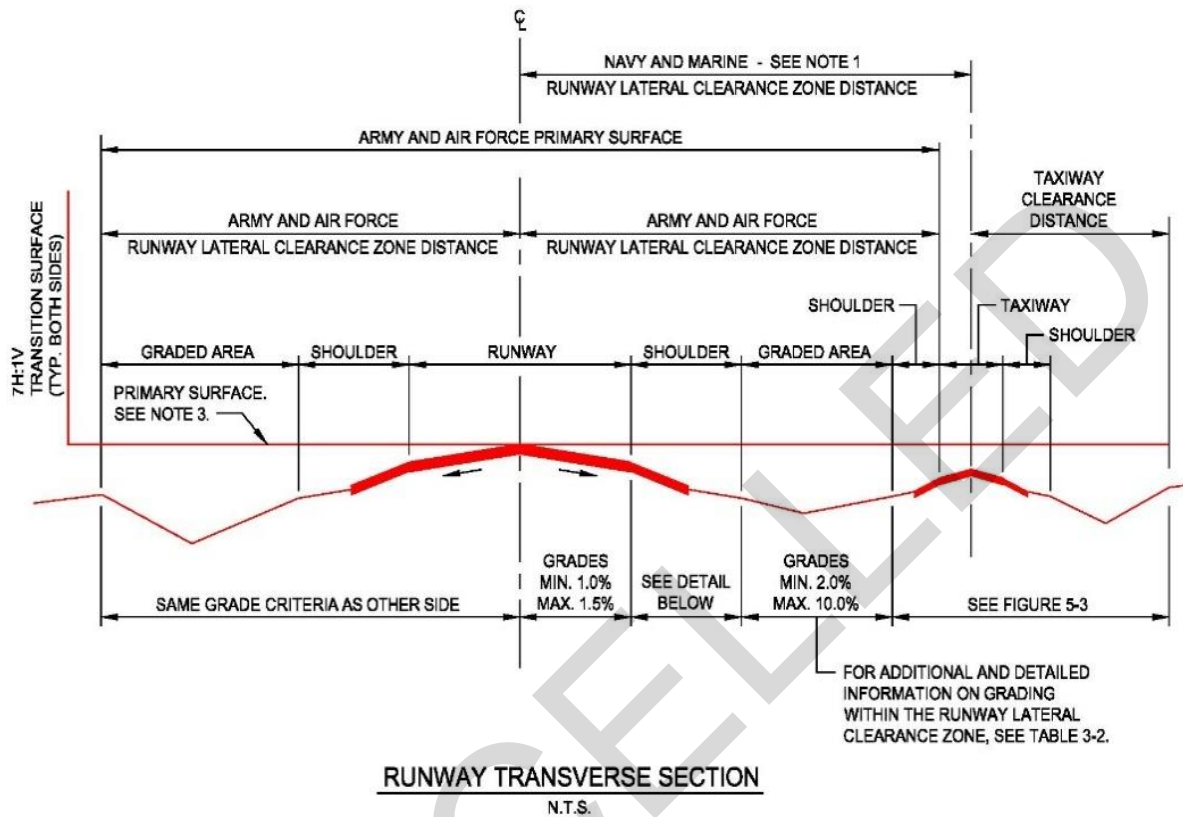

**NOTES**

1. AT NAVY AND MARINE CORPS AIRFIELDS, THE CENTERLINES OF A RUNWAY AND A PARALLEL TAXIWAY SHALL BE A MINIMUM OF 152.4 METERS [500 FEET] APART. FOR CLASS A AIRFIELDS, ONE-HALF OF THE PARALLEL TAXIWAY MAY BE LOCATED WITHIN THE LATERAL CLEARANCE ZONE. SEE TABLE 3-2.
2. PROVIDE A 40mm [1-1/2"] DROP-OFF FROM PAVED SHOULDERS.
3. THE PRIMARY SURFACE WIDTH IS COINCIDENT WITH THE RUNWAY LATERAL CLEARANCE ZONE WIDTH. THE ELEVATION OF ANY POINT ON THE PRIMARY SURFACE IS THE SAME AS THE ELEVATION OF THE NEAREST POINT ON THE RUNWAY CENTERLINE.
4. WHEN A SLOPE REVERSAL IS REQUIRED AT THE TOE OF THE SHOULDER, THE DESIGNER MUST PROVIDE AN ADEQUATELY FLAT BOTTOM DITCH.

**CLASS A AND CLASS B RUNWAYS**

Figure 3-2. Clear Zone Transverse Section Detail

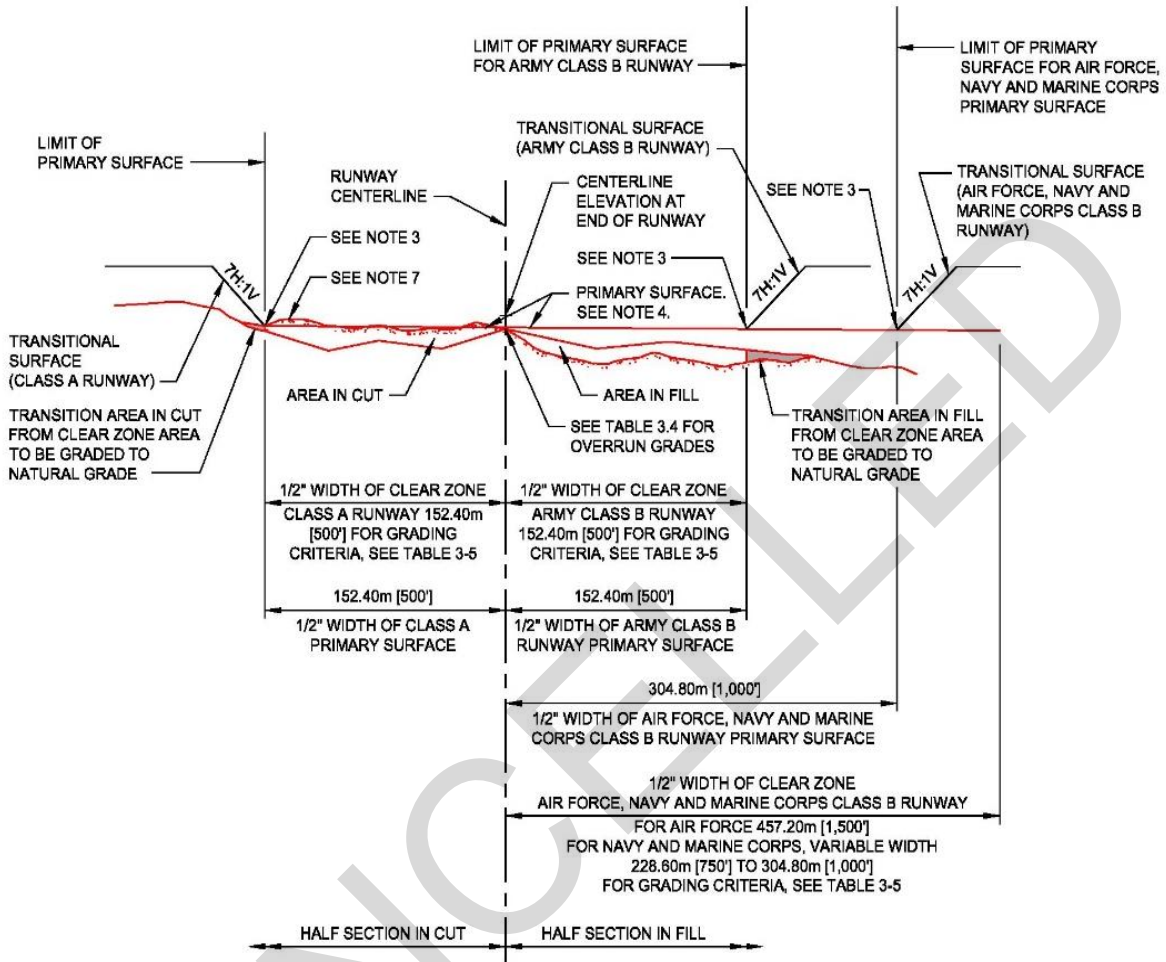

**CLEAR ZONE TRANSVERSE SECTION DETAIL**

N.T.S.

**NOTES**

1. TAKEN BEYOND END OF RUNWAY.
2. PRIMARY SURFACE APPLIES ONLY TO FIRST 60.96m [200'] BEYOND END OF RUNWAY.
3. THE STARTING ELEVATION FOR THE 7:1 TRANSITIONAL SURFACE IS THE ELEVATION OF THE PRIMARY SURFACE. REFER TO TABLE 3-7.
4. ELEVATION OF ANY POINT ON THE PRIMARY SURFACE IS THE SAME AS THE ELEVATION OF THE NEAREST POINT ON THE RUNWAY CROWN.
5. AT NAVY AND MARINE CORPS FACILITIES, THE PRIMARY SURFACE MAY BE 228.60m [750'].
6. DISTANCES ARE SYMETRICAL ABOUT CENTER OF RUNWAY.
7. NO PART OF THE AIRCRAFT OPERATIONS AREA WILL BE CONSIDERED AN OBSTRUCTION IF APPLICABLE GRADING CRITERIA ARE MET. GROUND SURFACES MAY PENETRATE THE PRIMARY SURFACE PROVIDED IT MEETS THE GRADING REQUIREMENTS. SEE PARAGRAPH 3.18.1.



Figure 3-3. Runway and Overrun Longitudinal Profile

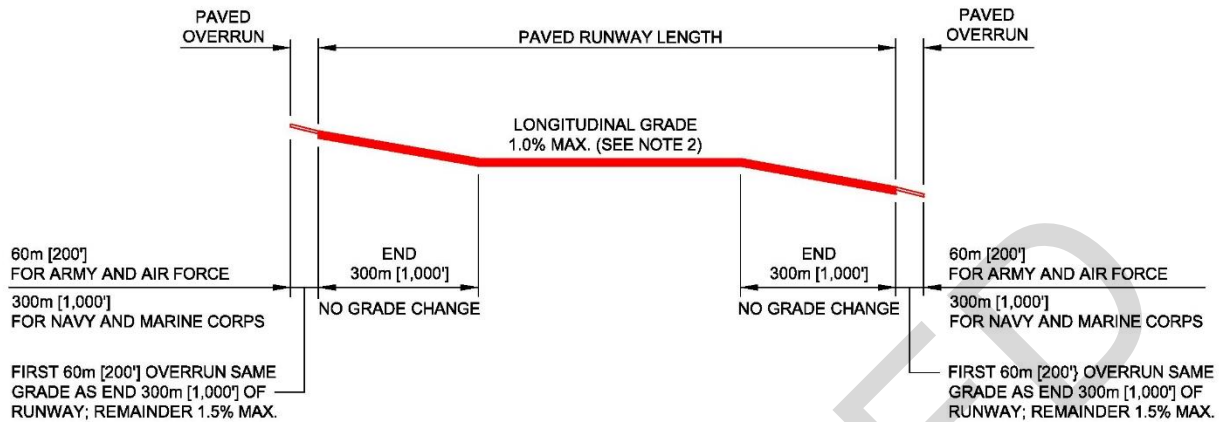

**CLASS A RUNWAY**  
N.T.S.

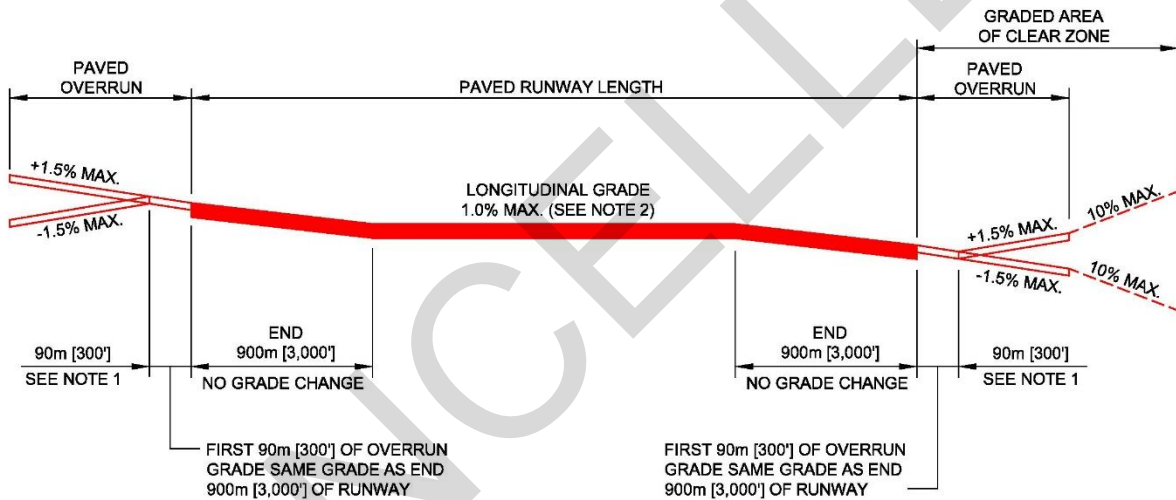

**CLASS B RUNWAY**  
N.T.S.

**NOTES**

1. TO AVOID ABRUPT CHANGES IN GRADE BETWEEN THE FIRST 90m [300'] OF THE OVERRUN AND THE REMAINDER OF THE OVERRUN, THE MAXIMUM CHANGE OF GRADE IS 2.0% PER 30m [100 L.F.].
2. GRADE MAY BE POSITIVE OR NEGATIVE BUT MUST NOT EXCEED THE LIMIT SPECIFIED.
3. SEE TABLE 3-5 FOR GRADING REQUIREMENTS BEYOND THE END OF THE OVERRUN.

Figure 3-4. Army Clear Zone and Accident Potential Zone Guidelines

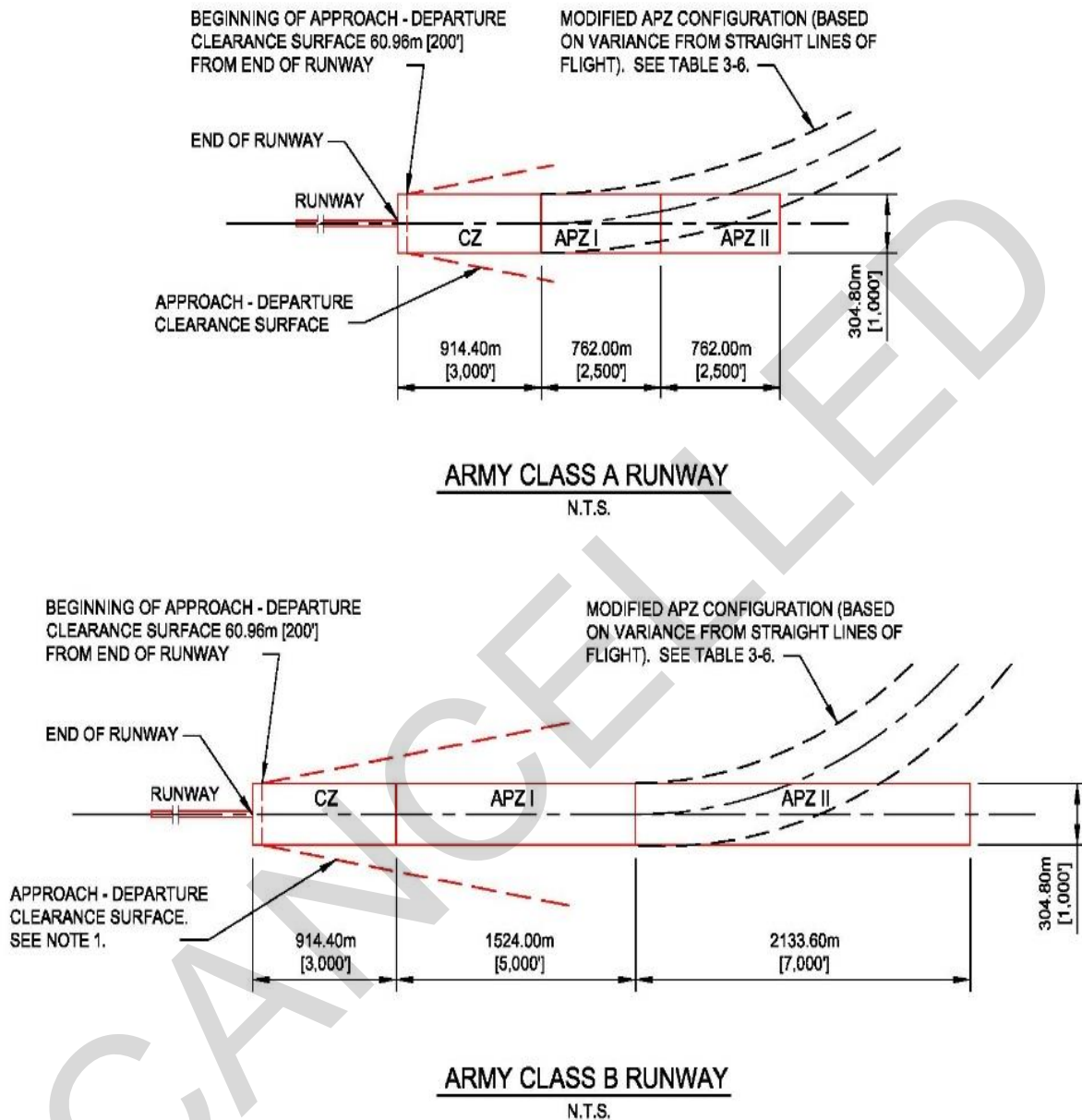

**NOTES**

1. THE WIDTH AND CONFIGURATION OF AN APPROACH - DEPARTURE CLEARANCE SURFACE ARE BASED ON THE CLASS OF RUNWAY, NOT THE WIDTH OF THE CLEAR ZONE.
2. FOR ADDITIONAL INFORMATION ON CLEAR ZONES, SEE TABLE 3-5.
3. FOR ADDITIONAL INFORMATION ON ACCIDENT POTENTIAL ZONES, SEE TABLE 3-6.

**LEGEND**

CZ	CLEAR ZONE
APZ I	ACCIDENT POTENTIAL ZONE I
APZ II	ACCIDENT POTENTIAL ZONE II

Figure 3-5. Air Force Clear Zone and APZ Guidelines

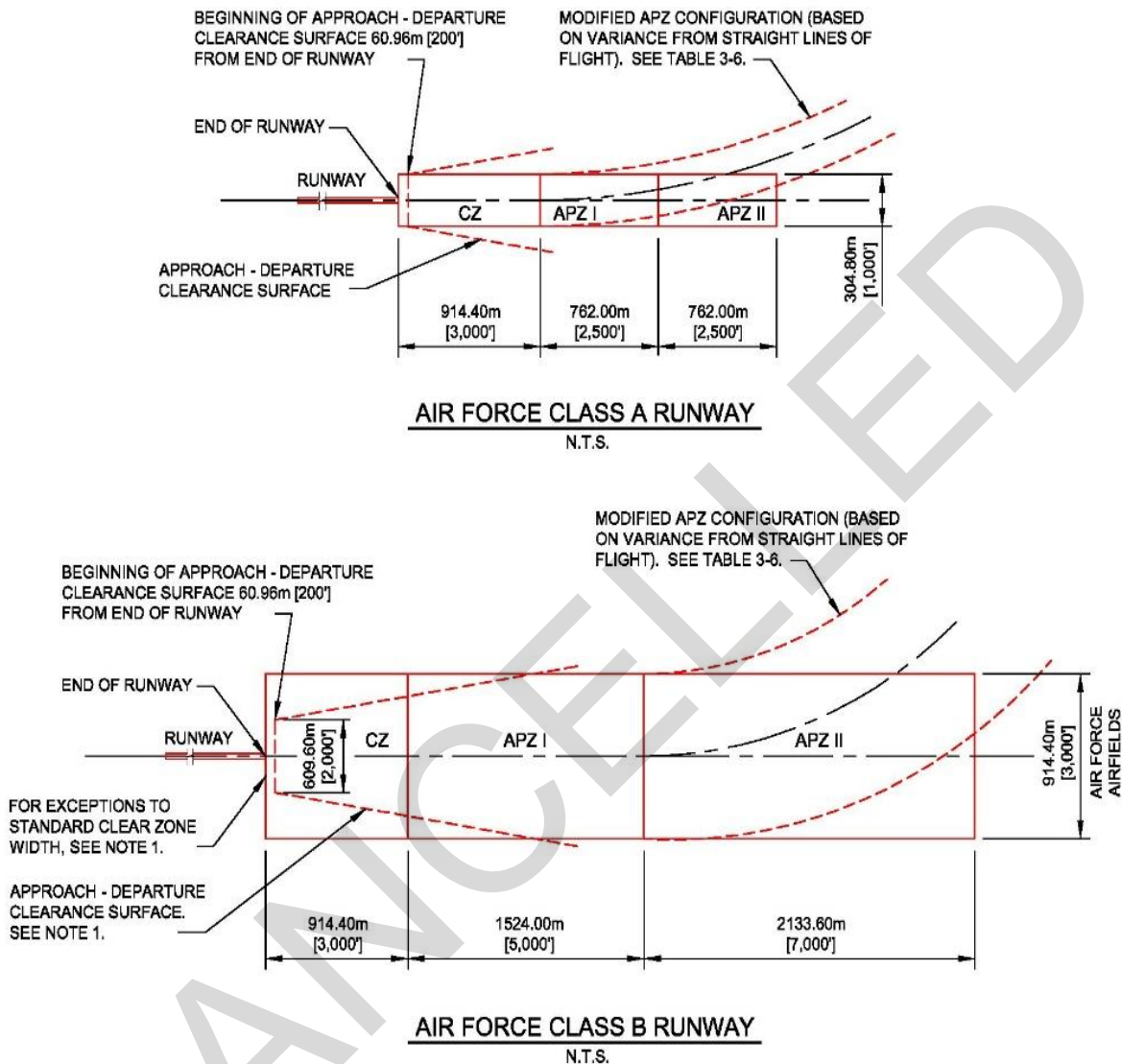

NOTES

- STANDARD WIDTH OF CLEAR ZONE MAY BE VARIED BASED ON INDIVIDUAL SERVICE ANALYSIS OF HIGHEST ACCIDENT POTENTIAL AREA AND LAND ACQUISITION CONSTRAINTS. HOWEVER, FOR NEW AIR FORCE CONSTRUCTION, A 914.40m [3,000'] WIDE CLEAR ZONE IS REQUIRED. SEE AFI 32-7063.
- THE WIDTH AND CONFIGURATION OF AN APPROACH - DEPARTURE CLEARANCE SURFACE ARE BASED ON THE CLASS OF RUNWAY, NOT THE WIDTH OF THE CLEAR ZONE.
- FOR ADDITIONAL INFORMATION ON CLEAR ZONES, SEE TABLE 3-5.
- FOR ADDITIONAL INFORMATION ON ACCIDENT POTENTIAL ZONES, SEE TABLE 3-6.

LEGEND

CZ	CLEAR ZONE
APZ I	ACCIDENT POTENTIAL ZONE I
APZ II	ACCIDENT POTENTIAL ZONE II

Figure 3-6. Navy and Marine Corps Clear Zone and APZ Guidelines

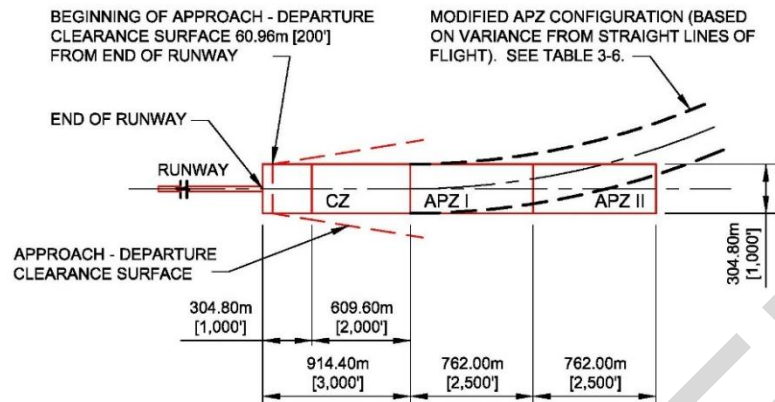

**NAVY AND MARINE CORPS CLASS A RUNWAY**  
N.T.S.

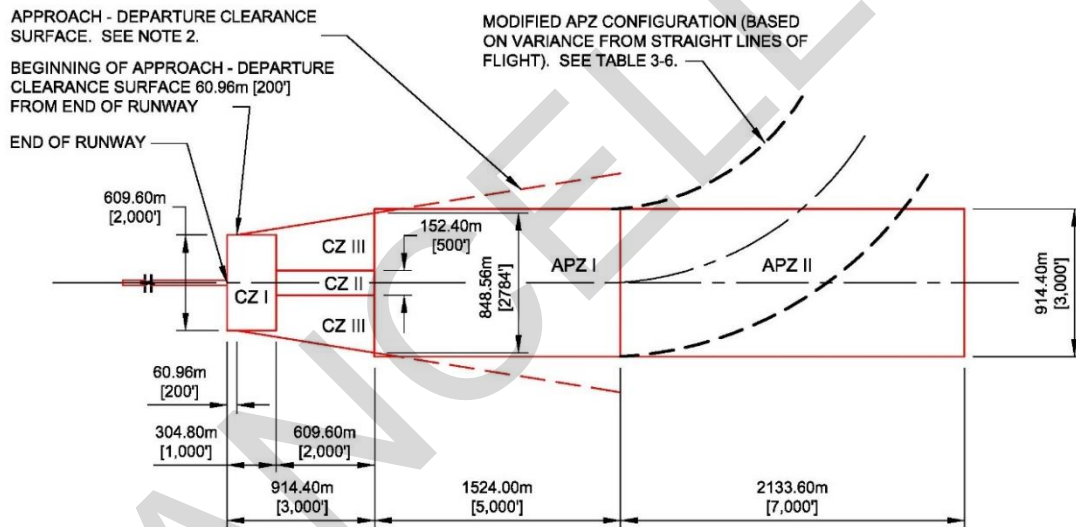

**NAVY AND MARINE CORPS CLASS B RUNWAY**  
N.T.S.

**NOTES**

1. MINIMUM WIDTH OF CLEAR ZONE IS BASED ON INDIVIDUAL SERVICE ANALYSIS OF HIGHEST ACCIDENT POTENTIAL AREA. FOR NAVY AND MARINE CORPS CONSTRUCTION, A 914.40m [3000'] WIDE CLEAR ZONE IS REQUIRED. SEE OPNAVINST 11010.38C/MCO11010.16 (OR LATEST VERSION).
2. THE WIDTH AND CONFIGURATION OF AN APPROACH - DEPARTURE CLEARANCE SURFACE ARE BASED ON THE CLASS OF RUNWAY, NOT THE WIDTH OF THE CLEAR ZONE.
3. FOR ADDITIONAL INFORMATION ON CLEAR ZONES, SEE TABLE 3-5.
4. FOR ADDITIONAL INFORMATION ON ACCIDENT POTENTIAL ZONES, SEE TABLE 3-6.

**LEGEND**

APZ I	ACCIDENT POTENTIAL ZONE I
APZ II	ACCIDENT POTENTIAL ZONE II
CZ	CLEAR ZONE
CZ I	TYPE I CLEAR ZONE
CZ II	TYPE II CLEAR ZONE
CZ III	TYPE III CLEAR ZONE

Figure 3-7. Class A VFR Runway Primary Surface End Details

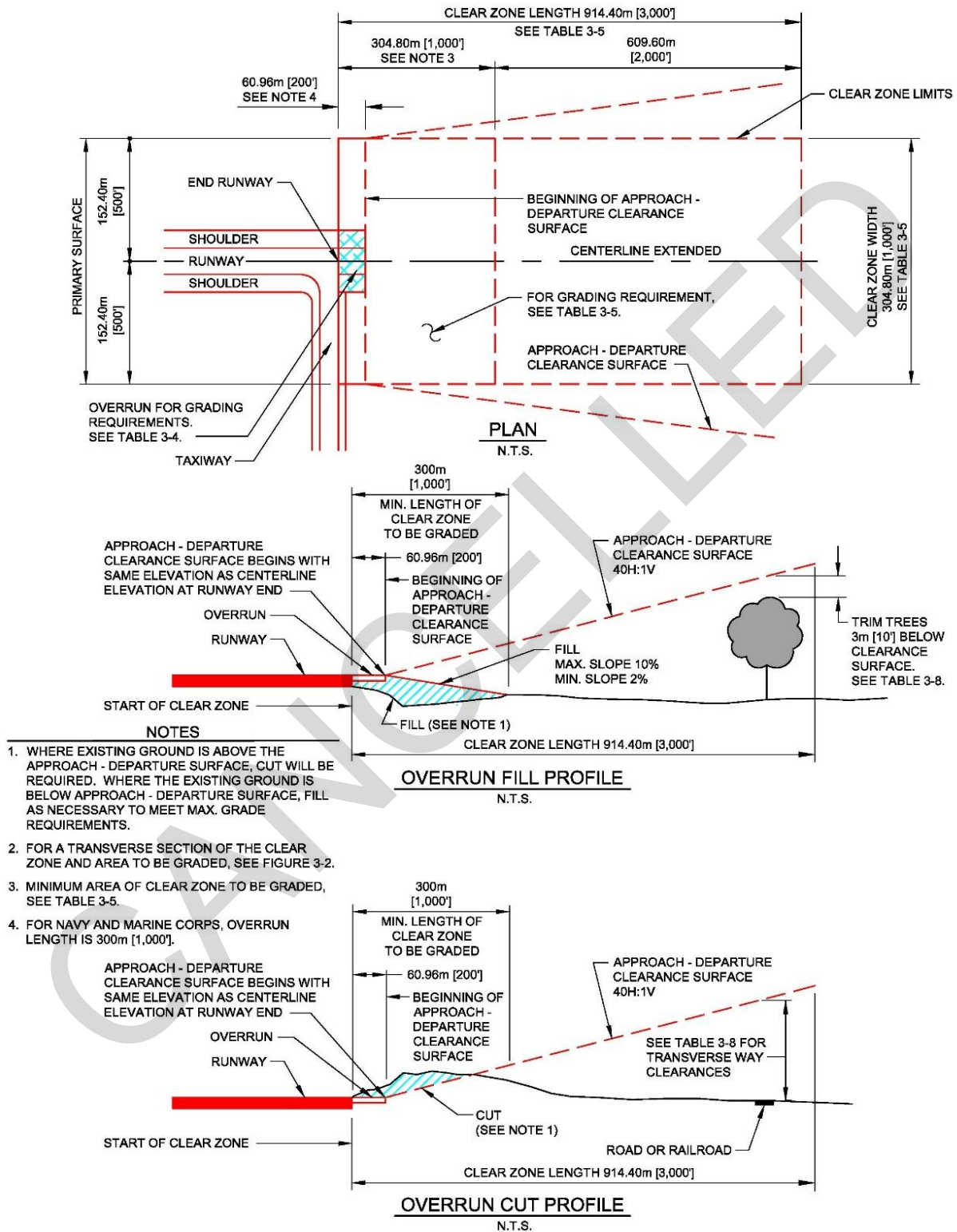
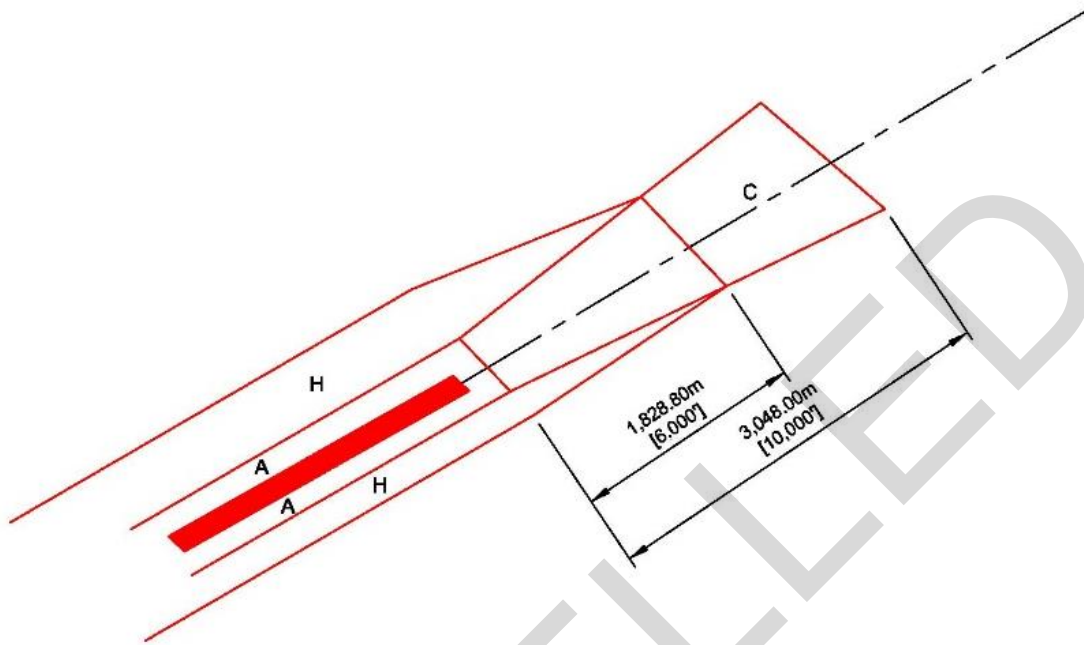

Figure 3-8. Class A VFR Runway Isometric Airspace Imaginary Surfaces



LEGEND

- A PRIMARY SURFACE
- B CLEAR ZONE SURFACE (NOT SHOWN)
- C APPROACH - DEPARTURE CLEARANCE SURFACE (40H:1V SLOPE RATIO)
- D APPROACH - DEPARTURE CLEARANCE SURFACE (HORIZONTAL) (NOT REQUIRED)
- E INNER HORIZONTAL SURFACE (NOT REQUIRED)
- F CONICAL SURFACE (NOT REQUIRED)
- G OUTER HORIZONTAL SURFACE (NOT REQUIRED)
- H TRANSITIONAL SURFACE (7H:1V SLOPE RATIO)
- I NOT USED
- J ACCIDENT POTENTIAL ZONE (APZ) (NOT SHOWN)

Figure 3-9. Class A VFR Runway Plan and Profile Airspace Imaginary Surfaces

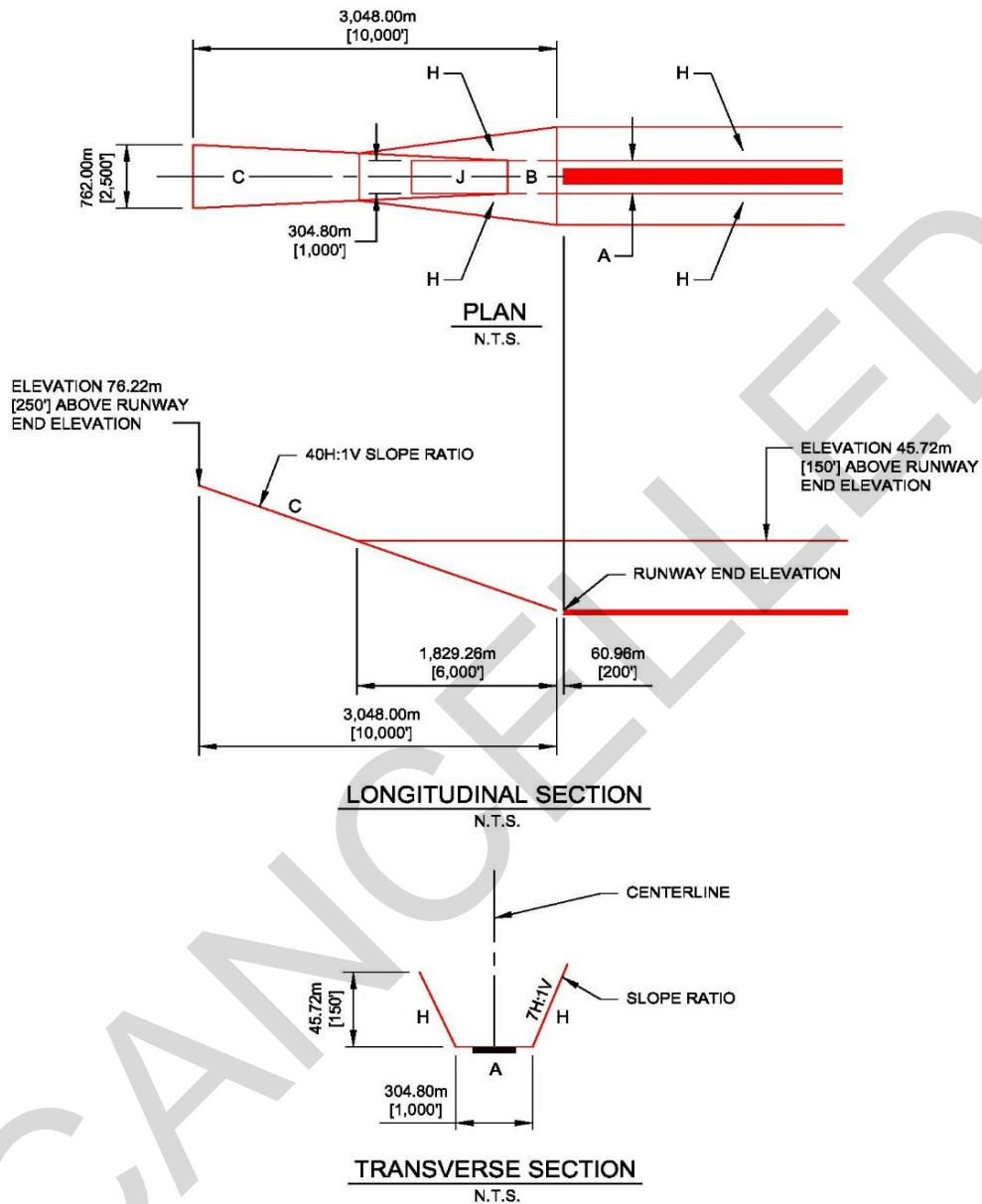

NOTES

1. DATUM ELEVATION FOR:
  - a. SURFACE C IS THE RUNWAY CENTERLINE ELEVATION AT THE THRESHOLD.
  - b. SURFACE H VARIES AT EACH POINT ALONG THE RUNWAY CENTERLINE. SEE TABLE 3-7.
2. THE SURFACES SHOWN ON THE PLAN ARE FOR THE CASE OF A LEVEL RUNWAY.

LEGEND

- |   |  |
|---|--|
| A | PRIMARY SURFACE  |
| B | CLEAR ZONE SURFACE   |
| C | APPROACH - DEPARTURE CLEARANCE SURFACE (SLOPE)                     |
| D | APPROACH - DEPARTURE CLEARANCE SURFACE (HORIZONTAL) (NOT REQUIRED) |
| E | INNER HORIZONTAL SURFACE (NOT REQUIRED)                            |
| F | CONICAL SURFACE (NOT REQUIRED)                                     |
| G | OUTER HORIZONTAL SURFACE (NOT REQUIRED)                            |
| H | TRANSITIONAL SURFACE   |
| I | NOT USED   |
| J | ACCIDENT POTENTIAL ZONE (APZ)                                      |

Figure 3-10. Class A IFR Runway Primary Surface End Details

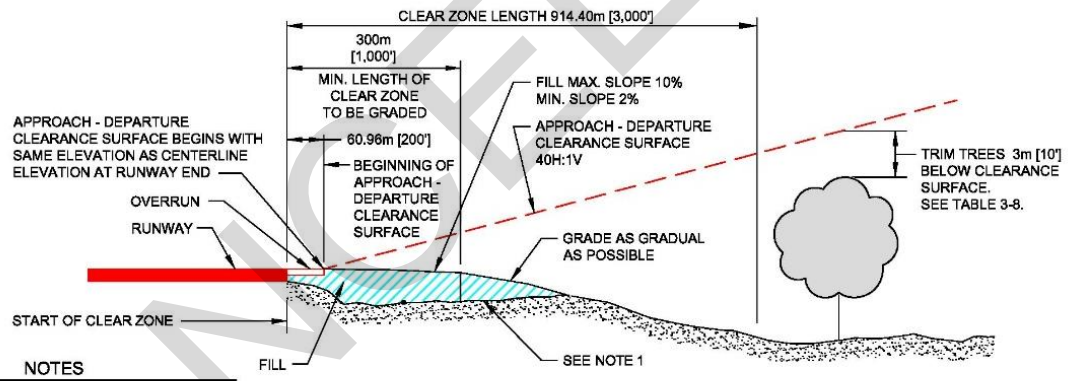
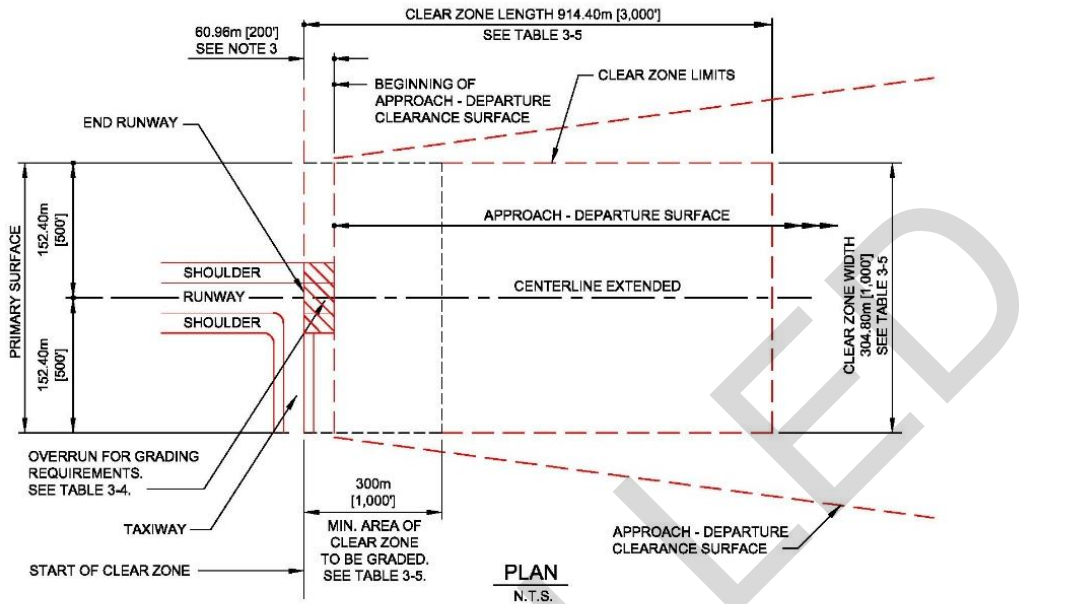

- NOTES**
1. WHERE EXISTING GROUND IS ABOVE THE APPROACH - DEPARTURE SURFACE, CUT WILL BE REQUIRED. WHERE THE EXISTING GROUND IS BELOW APPROACH - DEPARTURE SURFACE, FILL AS NECESSARY TO MEET MAX. GRADE REQUIREMENTS.
  2. FOR A TRANSVERSE SECTION OF THE CLEAR ZONE AND AREA TO BE GRADED, SEE FIGURE 3-2.
  3. FOR NAVY AND MARINE CORPS, OVERRUN LENGTH IS 300m [1,000'].

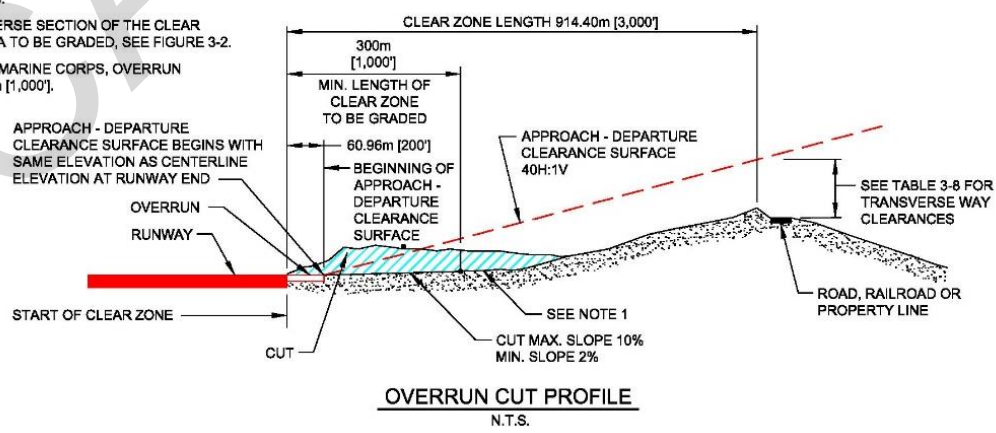
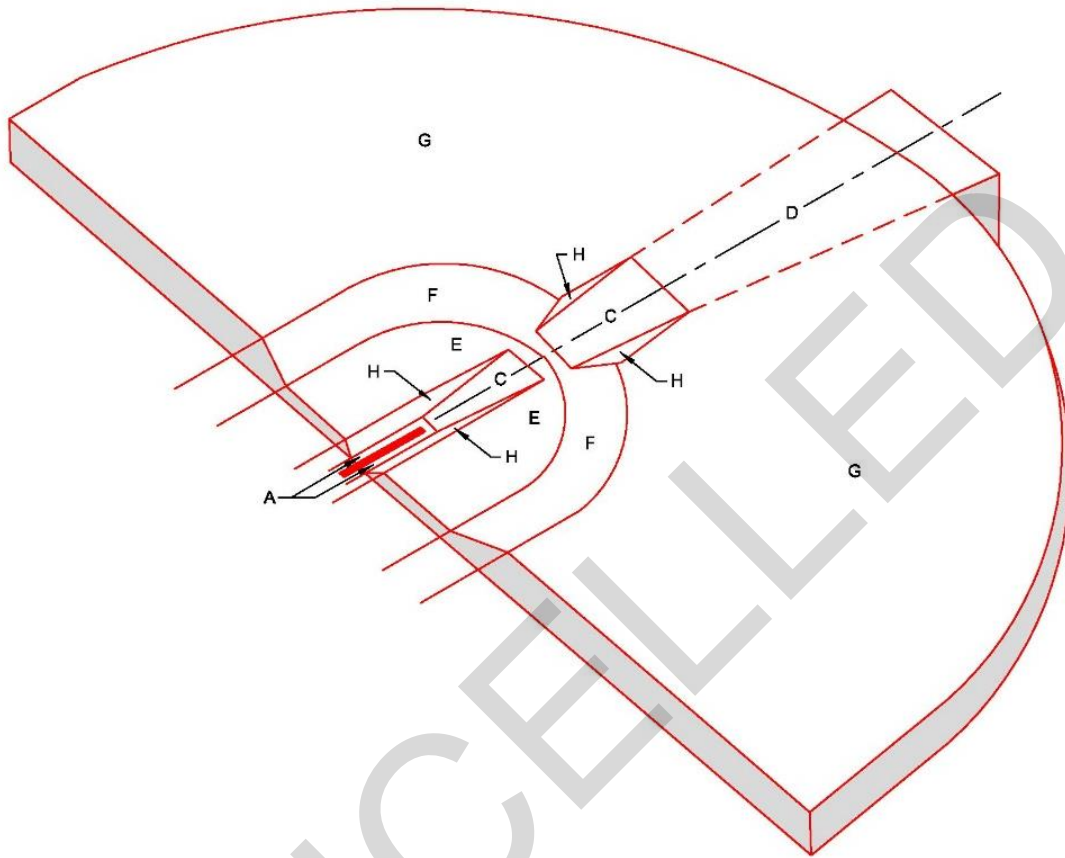



Figure 3-11. Class A IFR Runway Airspace Imaginary Surfaces



LEGEND

- A PRIMARY SURFACE
- B CLEAR ZONE SURFACE (NOT SHOWN)
- C APPROACH - DEPARTURE CLEARANCE SURFACE (SLOPE) (40H:1V RATIO)
- D APPROACH - DEPARTURE CLEARANCE SURFACE (HORIZONTAL)
- E INNER HORIZONTAL SURFACE (45.72m [150'] ELEVATION)
- F CONICAL SURFACE (20H:1V)
- G OUTER HORIZONTAL SURFACE (152.40m [500'] ELEVATION)
- H TRANSITIONAL SURFACE (7H:1V)
- I NOT USED
- J ACCIDENT POTENTIAL ZONE (APZ) (NOT SHOWN)

ISOMETRIC

N.T.S.

Figure 3-12. Class A IFR Runway Plan and Profile Airspace Imaginary Surfaces

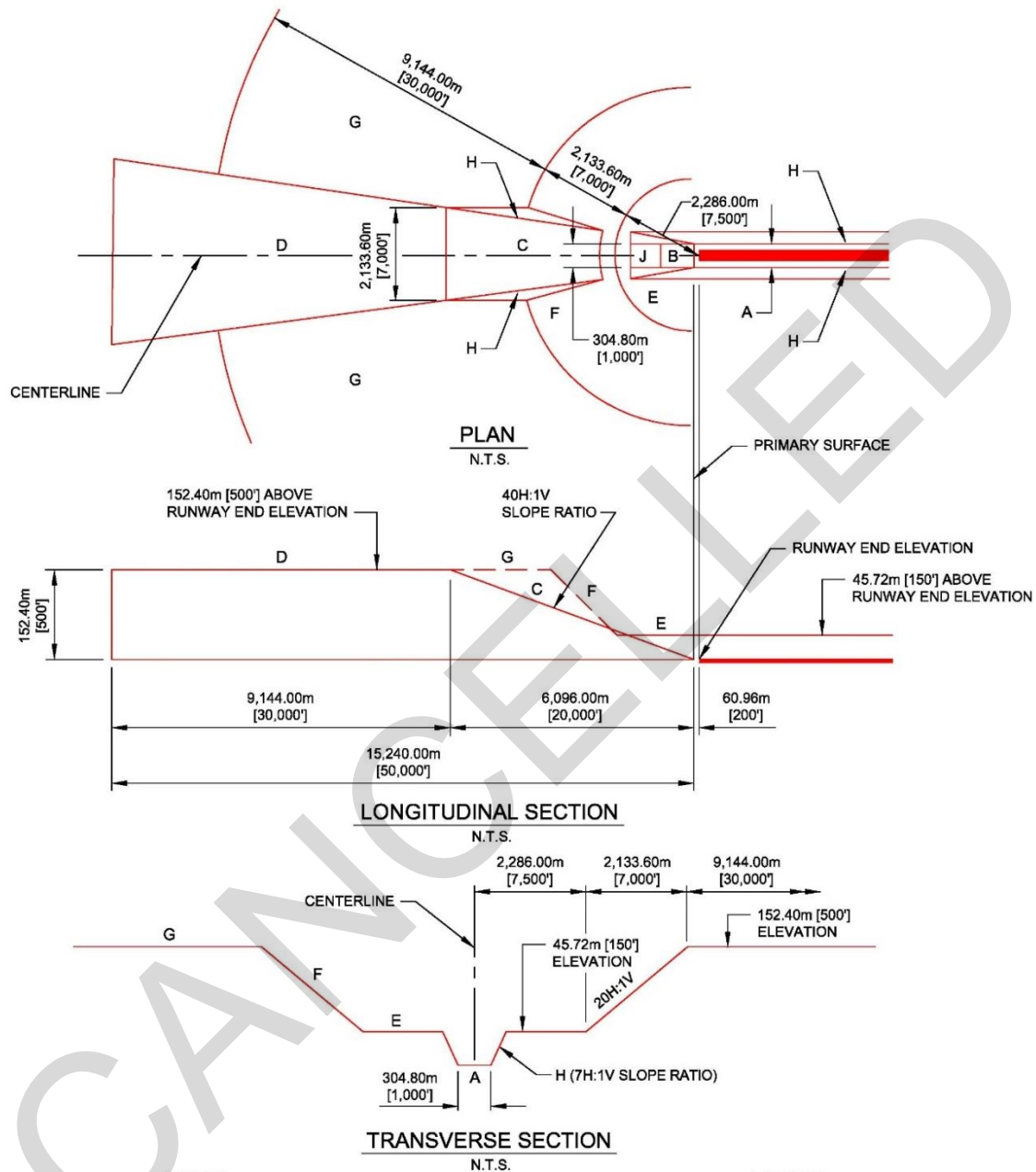

NOTES

1. DATUM ELEVATION FOR:
  - a. SURFACES D, E, F AND G ARE THE ESTABLISHED AIRFIELD ELEVATION.
  - b. SURFACE C IS THE RUNWAY CENTERLINE ELEVATION AT THE THRESHOLD.
  - c. SURFACE H VARIES AT EACH POINT ALONG THE RUNWAY CENTERLINE. SEE TABLE 3-7.
2. THE SURFACES SHOWN ON THE PLAN ARE FOR THE CASE OF A LEVEL RUNWAY.

LEGEND

- |   |   |
|---|---|
| A | PRIMARY SURFACE                                     |
| B | CLEAR ZONE SURFACE                                  |
| C | APPROACH - DEPARTURE CLEARANCE SURFACE (SLOPE)      |
| D | APPROACH - DEPARTURE CLEARANCE SURFACE (HORIZONTAL) |
| E | INNER HORIZONTAL SURFACE                            |
| F | CONICAL SURFACE                                     |
| G | OUTER HORIZONTAL SURFACE                            |
| H | TRANSITIONAL SURFACE                                |
| I | NOT USED  |
| J | ACCIDENT POTENTIAL ZONE (APZ)                       |

Figure 3-13. Class B Army and Air Force Runway End and Clear Zone Details

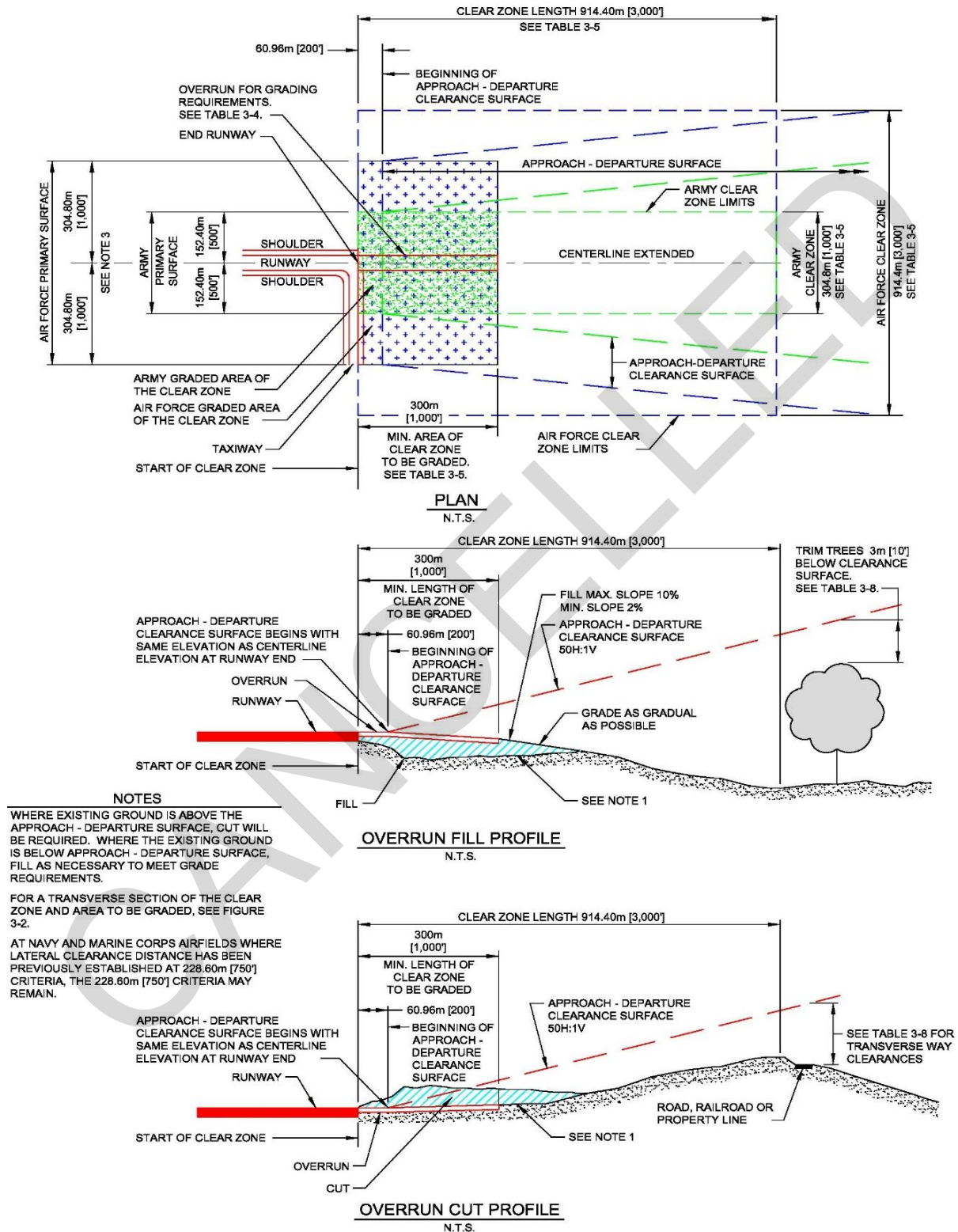
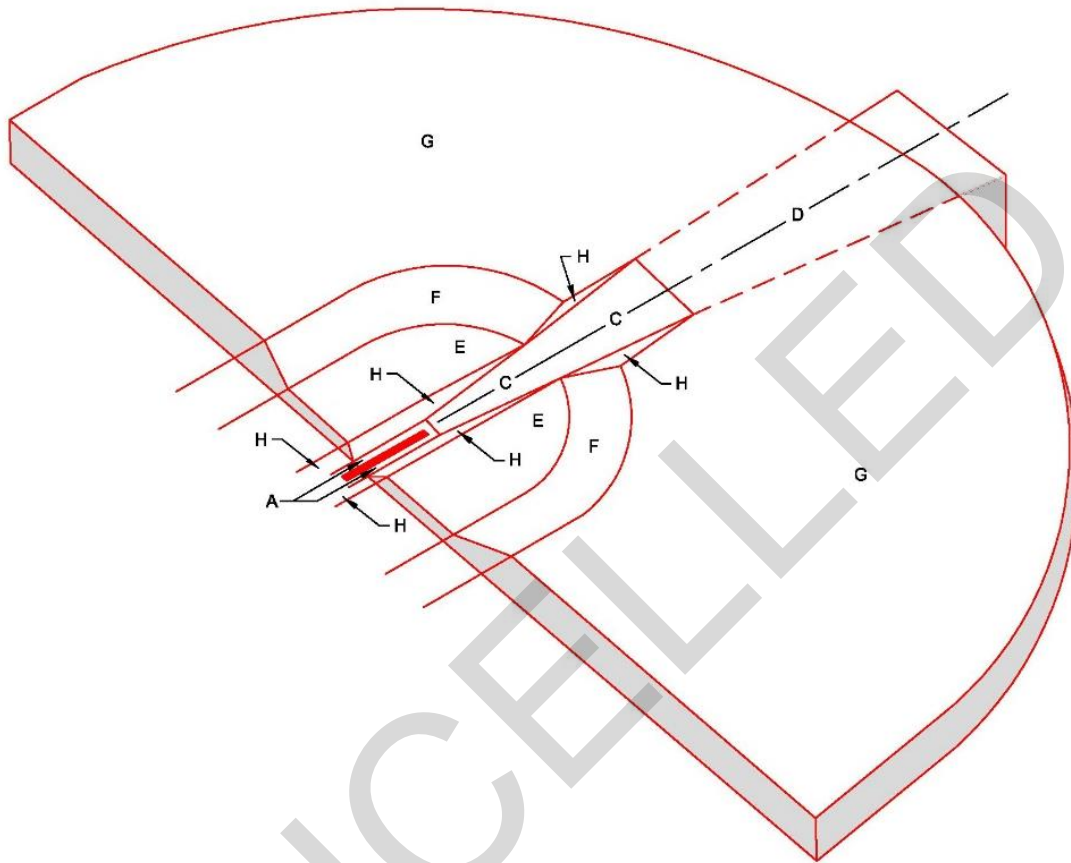

Figure 3-14. Class B Army Runway Airspace Imaginary Surfaces



**LEGEND**

- A PRIMARY SURFACE (304.80m [1000'] WIDE)
- B CLEAR ZONE SURFACE (NOT SHOWN)
- C APPROACH - DEPARTURE CLEARANCE SURFACE (SLOPE) (50H:1V RATIO)
- D APPROACH - DEPARTURE CLEARANCE SURFACE (HORIZONTAL)
- E INNER HORIZONTAL SURFACE (45.72m [150'] ELEVATION)
- F CONICAL SURFACE (20H:1V)
- G OUTER HORIZONTAL SURFACE (152.40m [500'] ELEVATION)
- H TRANSITIONAL SURFACE (7H:1V)
- I NOT USED
- J ACCIDENT POTENTIAL ZONE (APZ) (NOT SHOWN)

**ISOMETRIC**

N.T.S.

Figure 3-15. Class B Army and Air Force Runway Airspace Plan and Profile  
Runway Imaginary Surfaces

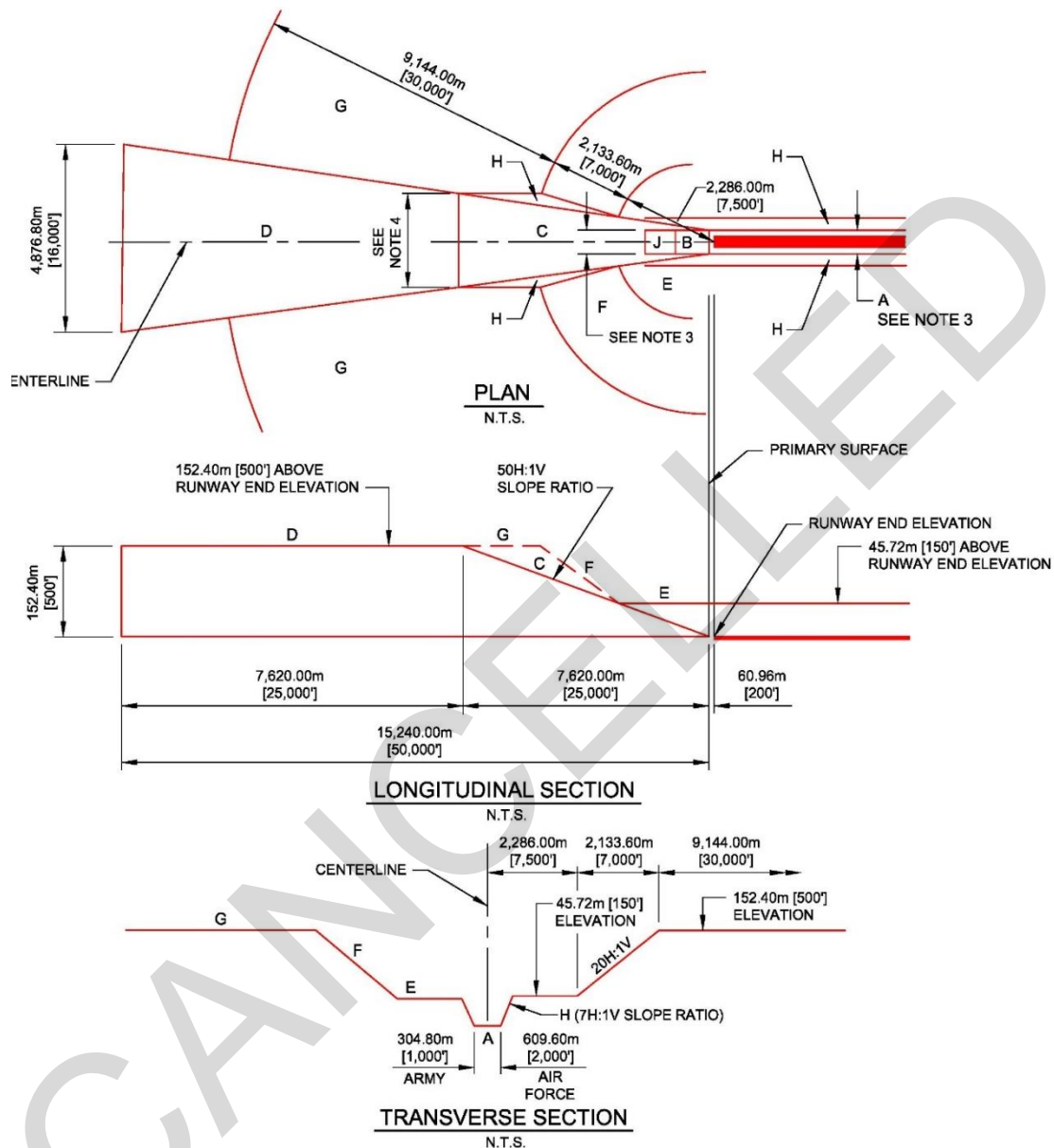

NOTES

1. DATUM ELEVATION FOR:
  - a. SURFACES D, E, F AND G ARE THE ESTABLISHED AIRFIELD ELEVATION.
  - b. SURFACE C IS THE RUNWAY CENTERLINE ELEVATION AT THE THRESHOLD.
  - c. SURFACE H VARIES AT EACH POINT ALONG THE RUNWAY CENTERLINE. SEE TABLE 3-7.
2. THE SURFACES SHOWN ON THE PLAN ARE FOR THE CASE OF A LEVEL RUNWAY.
3. 304.80m [1000'] FOR ARMY AND 609.60m [2000'] FOR AIR FORCE.
4. 2590.80m [8500'] FOR ARMY AND 2743.20m [9000'] FOR AIR FORCE.

LEGEND

- |   |   |
|---|---|
| A | PRIMARY SURFACE                                     |
| B | CLEAR ZONE SURFACE                                  |
| C | APPROACH - DEPARTURE CLEARANCE SURFACE (SLOPE)      |
| D | APPROACH - DEPARTURE CLEARANCE SURFACE (HORIZONTAL) |
| E | INNER HORIZONTAL SURFACE                            |
| F | CONICAL SURFACE                                     |
| G | OUTER HORIZONTAL SURFACE                            |
| H | TRANSITIONAL SURFACE                                |
| I | NOT USED  |
| J | ACCIDENT POTENTIAL ZONE (APZ)                       |

Figure 3-16. Class B Navy Runway Primary Surface End Details

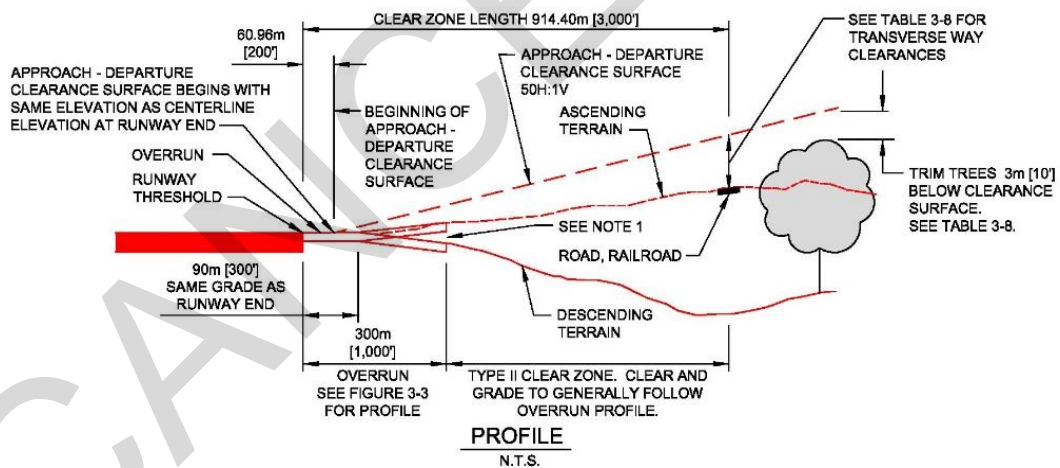
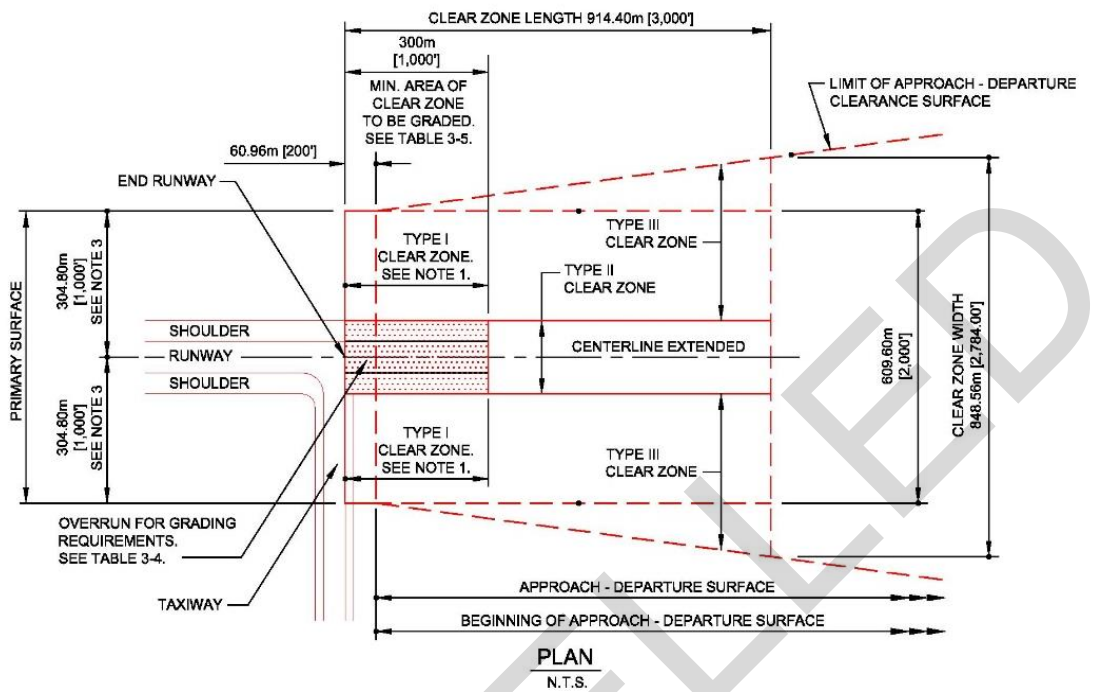

- NOTES**
- WHERE EXISTING GROUND IS ABOVE THE APPROACH - DEPARTURE SURFACE, CUT WILL BE REQUIRED.
  - WHERE THE EXISTING GROUND IS BELOW APPROACH - DEPARTURE SURFACE, FILL AS NECESSARY TO MEET MAX. GRADE REQUIREMENTS.  
TYPE I CLEAR ZONE IS TO BE CLEARED, GRADED AND FREE OF ABOVE GROUND OBJECTS.  
GRADES: LONGITUDINAL MAX. 10%, MAX. GRADE CHANGE  $\pm$  2.0% PER 30m [100']  
TRANSVERSE MAX. 10%, MIN. 2%
  - AT AIRFIELDS WHERE LATERAL CLEARANCE DISTANCE HAS BEEN PREVIOUSLY ESTABLISHED AT 228.60m [750'] CRITERIA, THE 228.60m [750'] CRITERIA MAY REMAIN.
- OVERRUN:** LONGITUDINAL GRADE, FIRST 90m [300'] SAME AS LAST 90m [3,000'] OF RUNWAY.  
REMAINDER 1.5% MAX.  
MAX. LONG GRADE CHANGE 2% PER 30m [100']  
TYPE II CLEAR ZONE CLEAR AND GRADE TO GENERALLY FOLLOW OVERRUN PROFILE.  
TYPE III CLEAR ZONE NOT GRADED.

Figure 3-17. Class B Air Force and Navy Runway Airspace Imaginary Surfaces

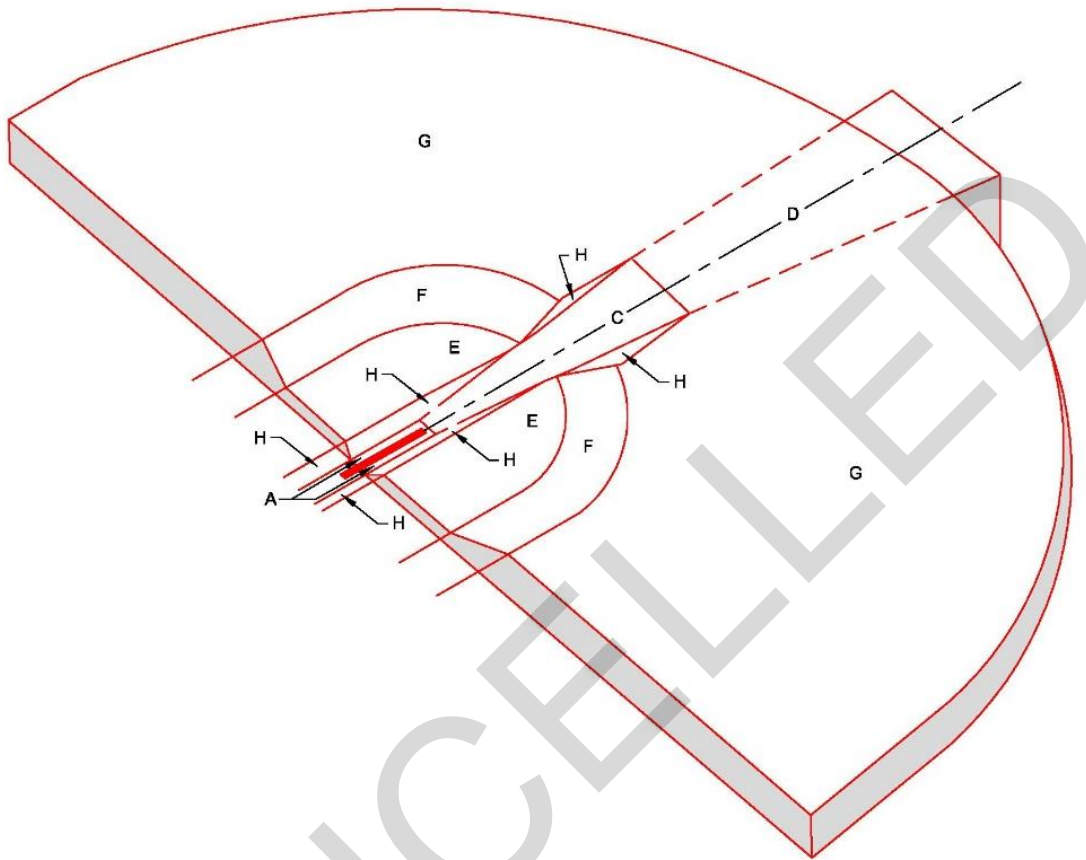

LEGEND

- A PRIMARY SURFACE
- B CLEAR ZONE SURFACE (NOT SHOWN)
- C APPROACH - DEPARTURE CLEARANCE SURFACE (SLOPE) (50H:1V RATIO)
- D APPROACH - DEPARTURE CLEARANCE SURFACE (HORIZONTAL)
- E INNER HORIZONTAL SURFACE (45.72m [150'] ELEVATION)
- F CONICAL SURFACE (20H:1V)
- G OUTER HORIZONTAL SURFACE (152.40m [500'] ELEVATION)
- H TRANSITIONAL SURFACE (7H:1V)
- I NOT USED
- J ACCIDENT POTENTIAL ZONE (APZ) (NOT SHOWN)

ISOMETRIC  
N.T.S.

Figure 3-18. Class B Navy Runway Airspace Plan and Profile Runway Imaginary Surfaces

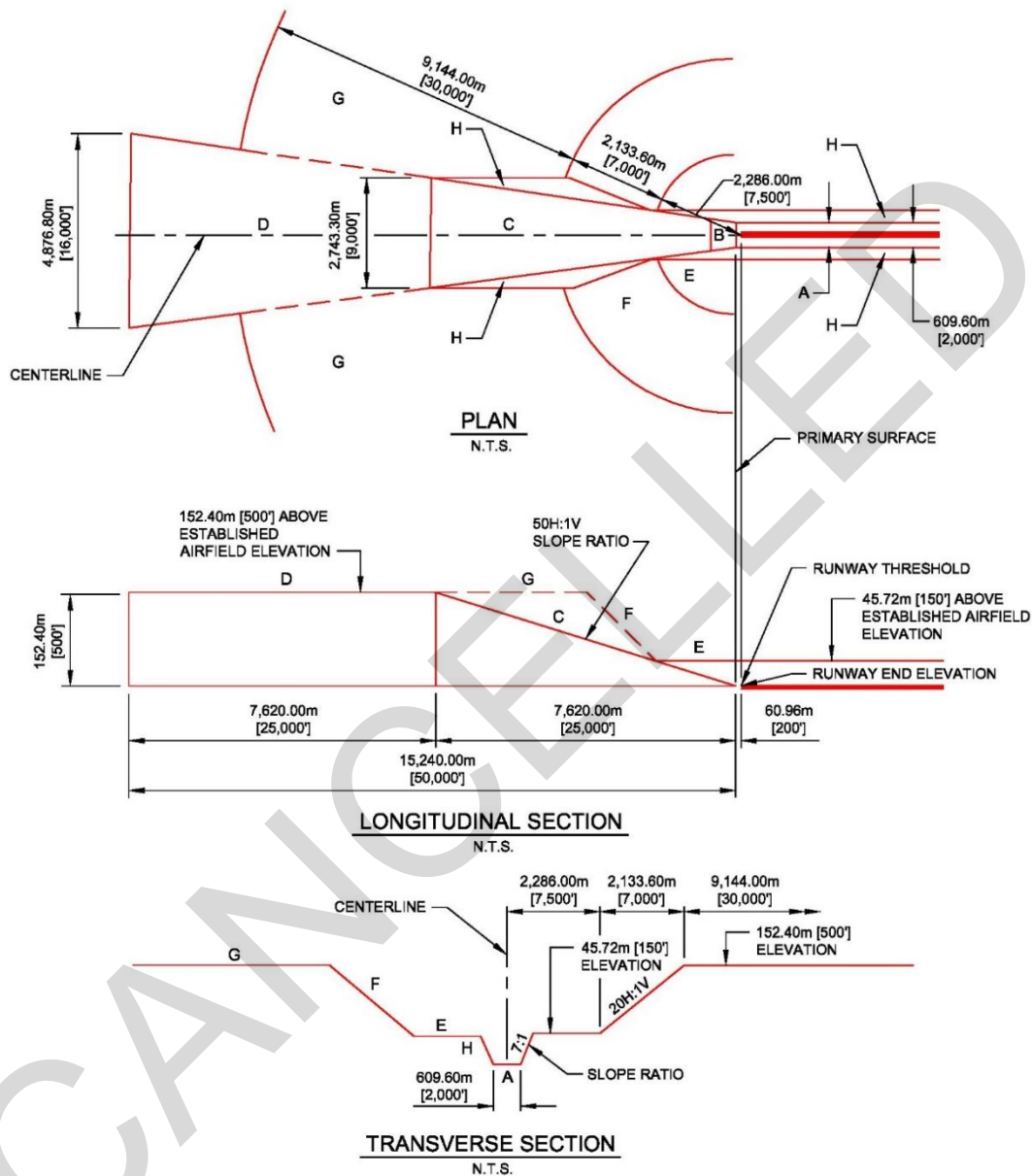

- NOTES**
- DATUM ELEVATION FOR:
    - SURFACES D, E, F AND G ARE THE ESTABLISHED AIRFIELD ELEVATION.
    - SURFACE C IS THE RUNWAY CENTERLINE ELEVATION AT THE THRESHOLD.
    - SURFACE H VARIES AT EACH POINT ALONG THE RUNWAY CENTERLINE. SEE TABLE 3-7.
  - THE SURFACES SHOWN ON THE PLAN ARE FOR THE CASE OF A LEVEL RUNWAY.

- LEGEND**
- A PRIMARY SURFACE
  - B CLEAR ZONE SURFACE
  - C APPROACH - DEPARTURE CLEARANCE SURFACE (SLOPE)
  - D APPROACH - DEPARTURE CLEARANCE SURFACE (HORIZONTAL)
  - E INNER HORIZONTAL SURFACE
  - F CONICAL SURFACE
  - G OUTER HORIZONTAL SURFACE
  - H TRANSITIONAL SURFACE
  - I NOT USED
  - J ACCIDENT POTENTIAL ZONE (APZ) (NOT SHOWN)



Figure 3-19. VFR and IFR Crosswind Runways Isometric  
Airspace Imaginary Surfaces

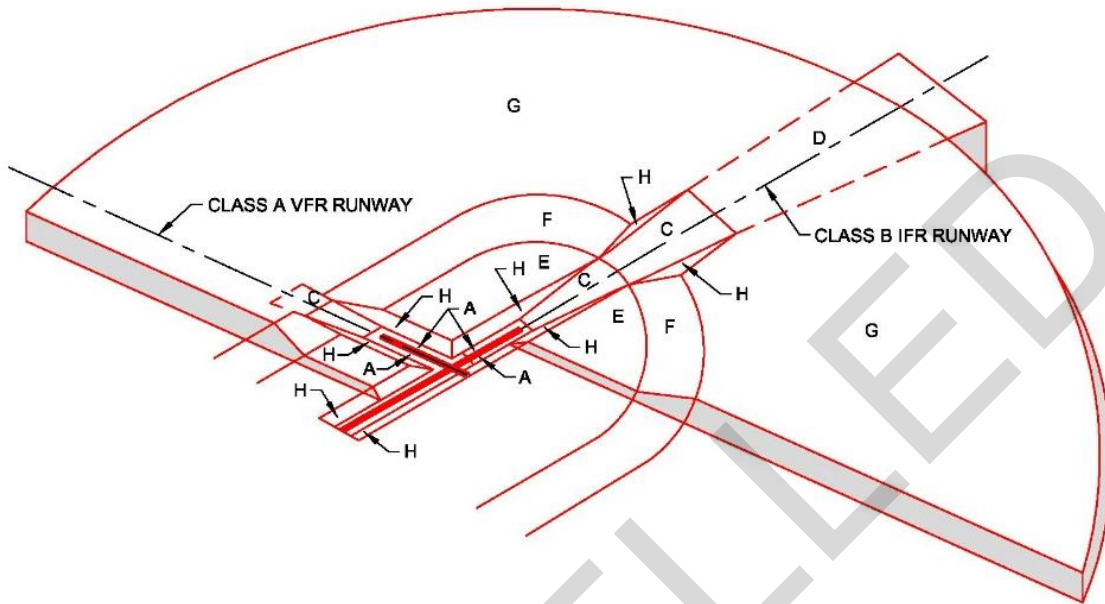

LEGEND

- A PRIMARY SURFACE
- B CLEAR ZONE SURFACE (NOT SHOWN)
- C APPROACH - DEPARTURE CLEARANCE SURFACE (SLOPE) (40:1 VFR, 50:1 IFR)
- D APPROACH - DEPARTURE CLEARANCE SURFACE (HORIZONTAL)
- E INNER HORIZONTAL SURFACE (45.72m [150'] ELEVATION)
- F CONICAL SURFACE (20H:1V)
- G OUTER HORIZONTAL SURFACE (152.40m [500'] ELEVATION)
- H TRANSITIONAL SURFACE (7H:1V)
- I NOT USED
- J ACCIDENT POTENTIAL ZONE (APZ) (NOT SHOWN)

ISOMETRIC  
N.T.S.

Figure 3-20. Plan, Single Runway, Navy Class A, and Basic Training Outlying Field

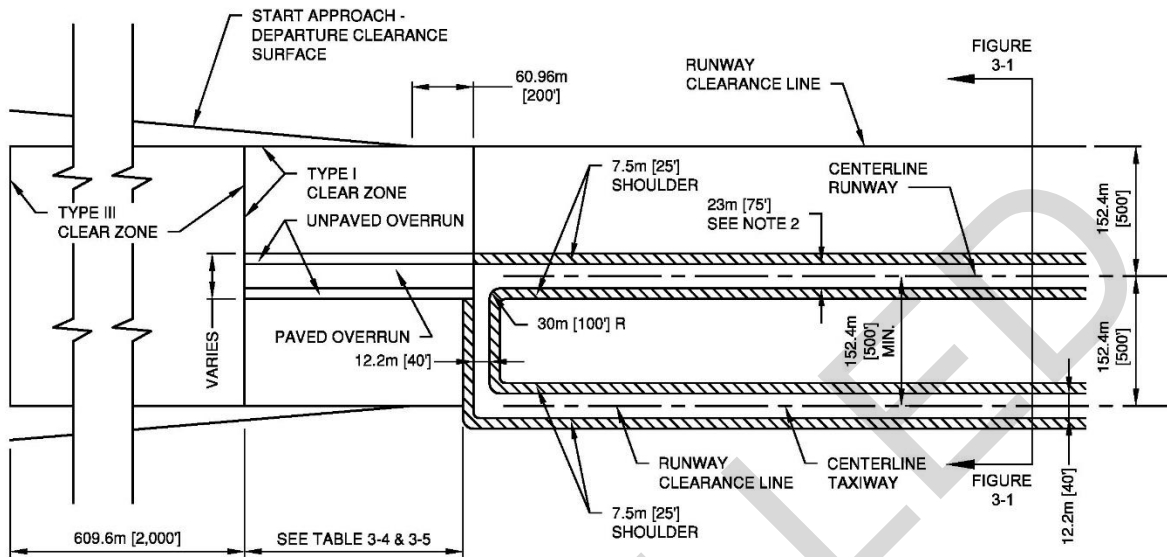

304.8m [1,000] WIDE CLEAR ZONE.  
SEE UFC 2-000-05N FOR OUTLYING CLEAR ZONE GUIDELINES.

**PLAN**  
N.T.S.

**NOTES**

1. SEE UFC 2-000-05N FOR SPECIFICS ON CLEAR ZONE AND APPROACH-DEPARTURE CLEARANCE SURFACES.
2. MINIMUM OF 23m [75'] WIDTH. WIDTH SHALL BE INCREASED TO 46m [150'] AT TRAINING COMMAND RUNWAYS FOR T-34 AND T-44 AIRCRAFT.
3. FOR DIMENSIONS OF SPECIFIC ELEMENTS, SEE APPROPRIATE TABLES.
4. FOR RADII OF FILLETS, REFER TO FIGURES 5-4 AND 5-5.
5. FOR NAVY AND MARINE CORPS AIRFIELDS PARALLEL TAXIWAYS MAY BE LOCATED WITHIN THE PRIMARY SURFACE A MINIMUM DISTANCE OF 152.4m [500'] FROM CENTERLINE OF RUNWAY TO CENTERLINE OF TAXIWAY.
6. FOR GRADES WITHIN THE PRIMARY SURFACE, SEE TABLE 3-2.
7. FOR OVERRUN, SEE TABLE 3-4.

Figure 3-21. Plan, Single Runway, and Navy Class B

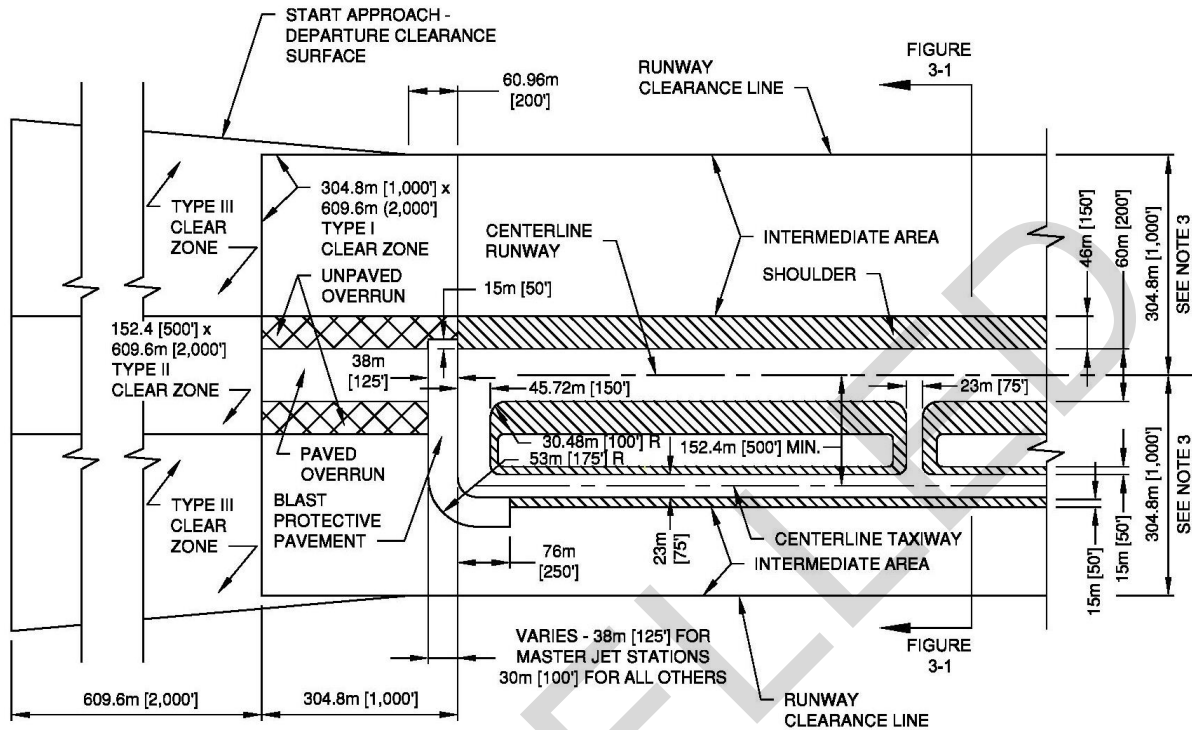

914.4m [3,000'] LONG CLEAR ZONE, WIDTH IS THE SAME AS APPROACH-DEPARTURE CLEARANCE SURFACE. SEE FIGURE 3-6 FOR DETAILS.

PLAN

N.T.S.

NOTES

1. SEE FIGURE 3-20 FOR SINGLE RUNWAY - CLASS A.
2. IN SOME CASES, THIS DIMENSION MAY BE REDUCED TO 228.6m [750']. SEE UFC 2-000-05N, PRIMARY SURFACE WIDTH.

Figure 3-22. Typical Layout, Navy Dual Class B Runways

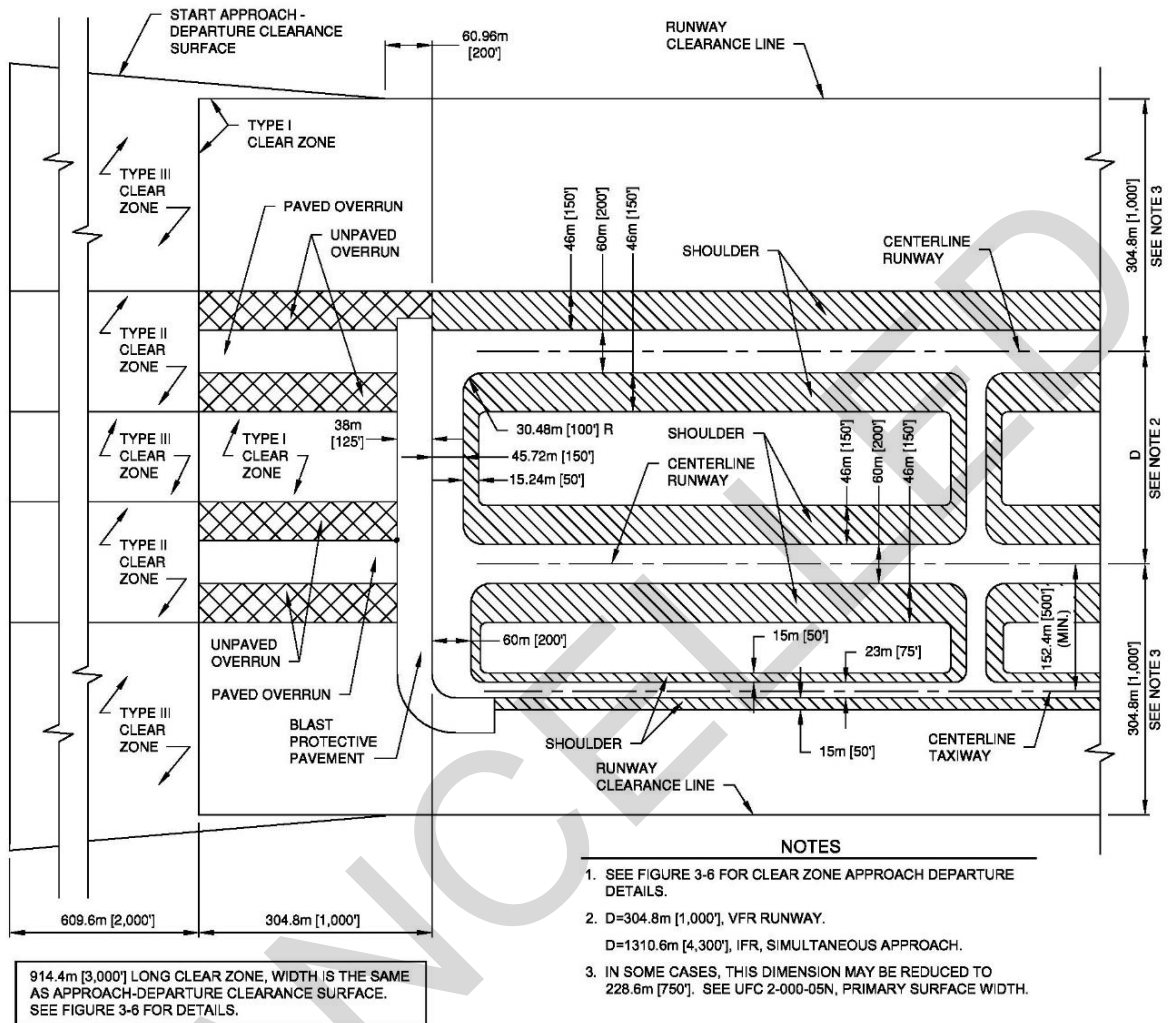

PLAN  
N.T.S.

### 3-10 SHOULDERS.

Unprotected areas adjacent to runways and overruns are susceptible to erosion caused by jet blast. Shoulders reduce the probability of serious damage to an aircraft to a minimum in the event that the aircraft runs off the runway pavement. The shoulder width, shown in Item 3 of Table 3-2, includes both paved and unpaved shoulders. Paved shoulders are required adjacent to all runways. The minimum paved shoulder width, shown in Table 3-2, allows the runway edge lights to be placed within the paved portion of the shoulder and to reduce foreign object damage (FOD) to aircraft. The unpaved shoulder will be graded to prevent water from ponding on the adjacent paved area (shoulder and runway). The drop-off next to the paved area prevents turf (which

may build up over the years) from ponding water. See Paragraph 2-12 for requirements for designing buried utility structures in shoulders.

**3-11 RUNWAY OVERRUNS.**

Runway overruns keep the probability of serious damage to an aircraft to a minimum in the event that the aircraft runs off the runway end during a takeoff or landing, or lands short during a landing. Overruns are required for the landing and takeoff area. Table 3-4 shows the dimensional requirements for overruns. Overrun profiles are shown in Figure 3-3, and an overrun layout is shown in Figures 3-7, 3-10, 3-13, and 3-16. USAF and Army design and construction requirements are covered in UFC 3-260-02 (Chapter 10, under "Special Areas"). See Paragraph 2-12 for requirements for designing buried utility structures in overruns.

In certain situations, mission capability may be improved by increased runway length for takeoff. With responsible airfield authority approval, this can sometimes be accomplished by strengthening the paved overrun to support full aircraft traffic, thereby extending the allowable takeoff length, but not changing the approach or departure surfaces or runway thresholds. This situation will require displaced threshold markings to indicate the landing threshold and may require changes to lighting systems. See Paragraph 3-9.2 for displaced threshold guidance.

**Table 3-4. Overruns**

Table 3-4. Overruns				
Item		Class A Runway	Class B Runway	Remarks
No.	Description	Requirement		
1	Length	60 m (200 ft)	300 m (1,000 ft)	Army and Air Force airfields. Pave the entire length.
		300 m (1,000 ft)		Navy and Marine Corps airfields. Pave the entire length. At outlying fields for T-34 aircraft, the required overrun length is 150 m (500 ft).
2	Total width of overrun (paved and unpaved)	Sum of runway and shoulders		The outside edges of the overrun, equal in width to the runway shoulder, are graded but not paved.
3	Paved overrun width	Same as width of runway		Center on runway centerline extended
4	Longitudinal centerline grade	First 60 m (200 ft) same as last 300 m (1,000 ft)	First 90 m (300 ft) same as last 900 m (3,000 ft) of runway.	To avoid abrupt changes in grade between the first 90 m (300 ft) and remainder of overrun of a Class B runway, the maximum change of grade is 2.0% per 30 linear m (100 linear ft).

Table 3-4. Overruns				
Item		Class A Runway	Class B Runway	Remarks
No.	Description	Requirement		
		of runway. Remainder 1.5% Max.	Remainder: 1.5% Max	
5	Transverse grade	Min 2.0% Max 3.0% 40 mm (1.5 in) drop-off at edge of paved overrun +/- 13 mm (0.5 in)		From centerline of overrun. Transition from the runway and runway shoulder grades to the overrun grades to be made within the first 45 m (150 ft) of overrun.

**Note:** Geometric design criteria in this manual are based on aircraft-specific requirements and are not direct conversions from inch-pound (English) dimensions. Inch-pound units are included only to permit reference to the previous standard.

### 3-12 RUNWAY CLEAR ZONES.

Runway clear zones are areas on the ground, located at the ends of each runway. They possess a high potential for accidents, and their use is restricted to be compatible with aircraft operations. Runway clear zones are required for the runway and should be owned or protected under a long-term lease. Table 3-5 shows the dimensional requirements for runway clear zones. Layout of the clear zones is shown in Figures 3-4, 3-5, 3-6, 3-7, 3-9, 3-10, 3-12, 3-13, 3-15, 3-16, 3-18, 3-20, 3-21, and 3-22. See Chapter 2, Para 2-12 for criteria for designing buried utility structures (manholes, handholes, drainage structures) in the Clear Zone.

#### 3-12.1 Land Use in Clear Zones.

The purpose of the clear zone is to protect the safety of flight and safety of people on the ground. The entire clear zone area is a land use control area intended to protect people both flight safety and property on the ground. DoDI 4165.57 and individual Service component directives govern land use within this area.

#### 3-12.2 Clear Zone Mandatory Frangibility Zone (MFZ).

For the USAF and Army, a MFZ extends through the land use control area to the end of the clear zone if on property owned or controlled by the USAF or Army, or to the base boundary if an aviation easement does not exist. Items that must be sited there due to their function must be made frangible, semi-frangible or low impact resistant to the maximum extent possible (see Appendix B, Section 13). Items that cannot be made frangible (such as highway guard rails) but must be located within this area for urgent and compelling reasons must be waived by the MAJCOM or USAASA in accordance with Appendix B, Section 1, before they are constructed. This is to ensure that all alternatives are considered before non-frangible structures are sited within this area. for additional information. Interaction with property owners whose land falls within the MFZ

is encouraged. Owners should be encouraged to make items in these areas frangible where practicable. For Air Force, see AFI 32-7063 for additional information.

**Table 3-5. Clear Zones**

Table 3-5. Clear Zones <sup>1</sup>				
Item		Class A Runway	Class B Runway	Remarks
No.	Description	Requirement		
1	Length	914.40 m (3,000 ft)	914.40 m (3,000 ft)	Measured along the extended runway centerline beginning at the runway end <sup>2</sup> . Although desirable, clearing and grading of the entire area is not required. For acceptable land uses in the clear zone, see AFI 32-7063 and AFH 32-7084 for USAF, and, OPNAVINST 11010.36C/MCO 11010.16 (or latest version), for Navy and Marine Corps. For grading requirements, see items 4 and 5.
2	Width at start of clear zone (adjacent to the runway)	304.80 m (1,000 ft)	304.80 m (1,000 ft)	Army airfields. Exception to these widths is permissible based on Army analysis of highest accident potential area for specific runway use and acquisition constraints.
			914.80 m (3,000 ft)	Air Force airfields. Though desirable, clearing and grading of the entire area is not required. For acceptable land uses in the clear zone, see AFI 32-7063 and AFH 32-7084 for USAF.
			609.60 m (2,000 ft)	Navy and Marine Corps: (See OPNAVINST 11010.36C/MCO 11010.16 (or latest version) for historical guidance where this dimension is 457 m (1,500 ft) for airfields built before 1981. For grading requirements, see items 4 and 5.
		See Remarks		Width of the clear zone is centered on and measured at right angles to the extended runway centerline. Refer to Figures 3-4, 3-5, and 3-6.
3	Width at end of clear zone	304.80 m (1,000 ft)	304.80 m (1,000 ft)	Army airfields. Exception to these widths is permissible based on Army analysis of highest accident potential area for specific runway use and acquisition constraints.
			914.40 m (3,000 ft)	Air Force airfields
		304.80 m (1,000 ft)	848.56 m (2,784 ft)	Navy and Marine Corps: See OPNAVINST 11010.36C/MCO 11010.16 (or latest version) for historical guidance for airfields built before 1981. The clear zone has the same dimensions as the approach-departure surface, as shown in Table 3-7. The first 60.96 m (200 ft) of the clear zone is a uniform 609.60 m (2,000 ft) in width, and which point the variable width begins.

Table 3-5. Clear Zones <sup>1</sup>				
Item		Class A Runway	Class B Runway	Remarks
No.	Description	Requirement		
			704.7 m (2,312 ft)	Navy and Marine Corps runways constructed prior to 1981 with 457.2m (1500 ft) primary surface.
		See Remarks		Width of the clear zone is centered on and measured at right angles to the extended runway centerline. Refer to Figures 3-4 (US Army), 3-5 (USAF), and 3-6 (US Navy and Marine Corps).
4	Longitudinal grade of area to be graded	Max 10.0%		For Army and Air Force, the area to be graded is 300 m (1,000 ft) in length by the established width of the primary surface. Grades are exclusive of the overrun, but are to be shaped into the overrun grade. The maximum longitudinal grade change cannot exceed $\pm 2.0\%$ per 30 m (100 ft). Grade restrictions are also exclusive of other pavements and shoulders. Where other pavements cross the graded area, comply with grading requirements for the specific pavement design (towways, taxiways, or aprons as applicable), but hold grade changes to the minimum practicable to facilitate drainage.  For Navy and Marine Corps, the area to be graded will be based on the type of clear zone, as shown in Figures 3-16, 3-20, 3-21, and 3-22.  For all Services, the graded area is to be cleared and grubbed of stumps and free of abrupt surface irregularities, ditches, and ponding areas. No aboveground structures (see note 3), objects, or roadways (except air traffic control controlled service roads to arresting gear or NAVAIDs) are permitted in the area to be graded, but gentle swales, subsurface drainage, covered culverts and underground structures are permissible. The transition from the graded area to the remainder of the clear zone is to be as gradual as feasible. For policy regarding permissible facilities, geographical features, and land use in the clear zone, refer to guidance furnished by each individual Service, and DoD AICUZ guidelines for clear zones and accident potential zones. (See Appendix B, Section 3.)
5	Transverse grade of area to be graded (in direction of surface drainage prior to channelization)	Min 2.0% Max 10.0%		
6	Width of USAF and Army MFZ	152.4 m (500 ft)		Centered on the extended runway centerline. All items sited within the MFZ in the graded area of the clear zone must be frangible. Man-made items located beyond the Graded Area of the clear zone but within the MFZ must be constructed to be frangible, low impact-resistant structures, or semi-frangible to the maximum extent possible (see Appendix B, Section 13).
7	Length of USAF and Army MFZ	914.4 m (3000 ft)		



**NOTES:**

1. Applicable to aviation facilities installations of the military departments in the United States, its territories, trusts, and possessions. For military facilities overseas, other than in locations designated, apply to the maximum practical extent.
2. For the definition of runway end refer to the glossary.
3. Essential NAVAID structure exceptions are discussed in Appendix B, Section 13.
4. Airfield and heliport imaginary surfaces and safe wingtip clearance dimensions are direct conversions from inch-pound to SI units.

**3-12.3 US Navy Clear Zones.**

Clear zones possess a high potential for accidents, and are subject to severe land use restrictions. For compatible land use assessment purposes, the clear zone is considered as one contiguous geometric area. Land use in the clear zone is governed by DoDI 4165.57 and OPNAVINST 11010.36C/MCO 11010.16 (or latest version). For the purpose of clear zone design, associated graded areas and approach-departure clearance requirements, the Navy defines three clear zone types as follows:

**3-12.3.1 Type I Clear Zone.**

This zone is immediately adjacent to the end of the runway. It will be cleared, graded, and free of above-ground objects (except airfield lighting) and is to receive special ground treatment or pavement in the area designated as the runway overrun. This clear zone is required at both ends of all runways.

**3-12.3.2 Type II Clear Zone.**

This zone is used only for Class B runways and is an extension of the Type I clear zone except that the width is reduced. The Type II clear zone will be graded and cleared of all above-ground objects except airfield lighting.

**3-12.3.3 Type III Clear Zone.**

This zone is laterally adjacent to the Type II clear zone for Class B runways and is used in lieu of the Type II clear zone at Class A runways and basic training outlying fields used by the T-34 aircraft. Objects in this zone will not penetrate the approach-departure clearance surface. Trees, shrubs, bushes, or any other natural growth will be topped 3 m (10 ft) below the approach-departure clearance surface or to a lesser height if necessary to ensure the visibility of airfield lighting. Traverse ways (e.g., roads, railroads, canals) are permitted provided that they would not penetrate airfield imaginary surfaces after the height of the traverse way has been increased by the distances specified in UFC 2-000-05N.

**3-13 ACCIDENT POTENTIAL ZONES (APZ).**

APZs are areas on the ground located beyond the clear zone of each runway. They possess a potential for accidents, and land use in APZs is governed in accordance with DoDI 4165.57 and Service-specific AICUZ directives. Table 3-6 shows the dimensional

requirements for runway APZs. Layout of APZs is shown in Figure 3-4 for the Army, Figure 3-5 for the Air Force, and Figure 3-6 for the Navy. Navy planners will use OPNAVINST 11010.36C/MCO 11010.16 (or latest version) to determine specific AICUZ requirements. For the Air Force, land use guidelines within the clear zone (beyond the graded area) and APZ I and APZ II are provided in AFI 32-7063 and AFH 32-7084.

**3-14 AIRSPACE IMAGINARY SURFACES.**

The area surrounding a runway that must be kept clear of objects that might damage an aircraft is bounded by imaginary surfaces that are defined in this manual. An object, either man-made or natural, that projects above an imaginary surface is an obstruction. Imaginary surfaces for fixed-wing airfields are shown in Figures 3-6 through 3-22 and are defined in the glossary. The applicable dimensions and slopes are provided in Table 3-7. These imaginary surfaces include:

- Primary surface
- Approach-departure surface
- Inner horizontal surface
- Conical surface
- Outer horizontal surface
- Transitional surface
- The graded portion of the clear zone

**Table 3-6. Accident Potential Zones (APZs)**

Table 3-6. Accident Potential Zones (APZs)				
Item		Class A Runway	Class B Runway	
No.	Description	Requirement		Remarks
1	APZ I length	762.00 m (2,500 ft)	1,524.00 m (5,000 ft)	APZ I starts at the end of the clear zone, and is centered and measured on the extended centerline.
2	APZ I width	304.80 m (1,000 ft)	304.80 m (1,000 ft)	Army airfields
			914.400 m (3,000 ft)	Air Force, Navy, and Marine Corps airfields
3	APZ II length	762.00 m (2,500 ft)	2,133.60 m (7,000 ft)	Standard APZ II starts at the end of the APZ I and is centered and measured on the extended runway centerline.
4	APZ II width	304.80 m (1,000 ft)	304.80 m (1,000 ft)	Army airfields
			914.40 m (3,000 ft)	Air Force, Navy, and Marine Corps airfields

**NOTES:**

1. Applicable to aviation facilities of the military departments in the United States, its territories, trusts, and possessions. For military facilities overseas, other than in locations designated, follow the guidance of the individual Service component.
2. For guidance on land use within the APZs, see land use compatibility guidelines in DoD AICUZ guidelines (Appendix B, Section 3). For USAF, see AFI 32-7063 and AFH 32-7084. For Navy and Marine Corps, see OPNAVINST 11010.36C/MCO 11010.16 (or latest version).
3. Airfield and heliport imaginary surfaces and safe wingtip clearance dimensions are shown as a direct conversion from inch-pound to SI units.

**Table 3-7. Airspace Imaginary Surface**

Table 3-7. Airspace Imaginary Surfaces						
Item		Legend	Class A Runway Requirement		Class B Runway Requirement	Remarks
No.	Description		VFR	IFR	VFR and IFR	
1	Primary surface width	A	304.80 m (1,000 ft)	304.80 m (1,000 ft)		
					304.80 m (1,000 ft)	Army airfields
					609.60 m (2,000 ft)	Air Force, Navy, and Marine Corps airfields
			See Remarks			<p>Centered on the runway centerline. At US Navy and Marine Corps airfields where the lateral clearance was established according to the previous 228.60 m (750 ft) from centerline criterion, the 457.2-m (1500-ft) distance may remain.</p> <p>For USAF, the primary surface width was expanded 10 Nov 64. Facilities constructed under the previous standard are exempt. See Chapter 1 and Appendix B, Section 17. Parallel taxiways located within the primary surface under previous standards may remain but should be evaluated for continued use in the current location when major repairs are necessary.</p> <p>For Navy and Marine Corps, this surface was expanded on 12 May 1981.</p>

Table 3-7. Airspace Imaginary Surfaces

Item		Legend	Class A Runway Requirement		Class B Runway Requirement	Remarks
No.	Description		VFR	IFR	VFR and IFR	
2	Primary surface length	A	Runway Length + 60.96 m (200 ft) at each end			Primary surface extends 60.96 m (200 ft) beyond each end of the runway.
3	Primary surface elevation	A	The elevation of any point on the primary surface is the same as the elevation of the nearest point on the runway centerline.			
4	Clear zone surface (graded area)	B	See Table 3-5			Graded area only. For land use in the clear zone, apply AICUZ standards. For USAF, see AFI 32-7063 and AFH 32-7084; for US Army, see Appendix B, Section 3. For Navy and Marine Corps, see OPNAVINST 11010.36C/MCO 11010.16 (or latest version).
5	Start of approach-departure surface	C	60.96 m (200 ft)			Measured from runway threshold.
6	Length of sloped portion of approach-departure surface	C	3,048.00 m (10,000 ft)	6,096.00 m (20,000 ft)	7,620.00 m (25,000 ft)	Measured horizontally.
7	Slope of approach-departure surface	C	40:1	40:1	50:1	Slope ratio is horizontal: vertical. Example: 40:1 is 40 m (ft) horizontal to 1 m (ft) vertical. For clearances over highway and railroads, see Table 3-8.
8	Width of approach-departure surface at start of sloped portion	C	304.80 m (1,000 ft)	304.80 m (1,000 ft)	304.80 m (1,000 ft)	Army airfields.
					609.60 m (2,000 ft)	Air Force, Navy, and Marine Corps airfields.
			See Remarks			Centered on the extended runway centerline, and is the same width as the Primary Surface. For Navy and Marine Corps airfields where the lateral clearance distance has been established according to the previous 228.60 m (750 ft) from centerline criterion, the 457.20-m

Table 3-7. Airspace Imaginary Surfaces						
Item		Legend	Class A Runway Requirement		Class B Runway Requirement	Remarks
No.	Description		VFR	IFR	VFR and IFR	
						(1,500-ft) distance at the start of the approach-departure clearance surface may remain.
9	Width of approach-departure surface at end of sloped portion	C	762.00 m (2,500 ft)	2,133.60 m (7,000 ft)	2,590.80 m (8,500 ft) See Note 4	Army Airfields
					2,743.20 m (9,000 ft) See Note 4	Air Force Airfields
					See Remarks	
10	Elevation of approach-departure surface at start of sloped portion	C	See Remarks			Same as the runway centerline elevation at the threshold.
11	Elevation of approach-departure surface at end of sloped portion	C	76.20 m (250 ft)	152.40 m (500 ft)	152.40 m (500 ft)	Above the established airfield elevation.
12	Start of horizontal portion of approach-departure surface	D	N/A	6,096.00 m (20,000 ft) See Note 4	7,620.00 m (25,000 ft) See Note 4	Measured from the end of the primary surface. The end of the primary surface (start of the approach-departure surface) is 60.96 m (200 ft) from the end of the runway.
13	Length of horizontal portion of approach-departure surface	D	N/A	9,144.00 m (30,000 ft)	7,620.00 m (25,000 ft)	Measured horizontally along the ground.
14	Width of approach-departure surface at start of horizontal portion	D	N/A	2,133.60 m (7,000 ft) See Note 4	2,743.20 m (9,000 ft) See Note 4	Centered along the runway centerline extended.

Table 3-7. Airspace Imaginary Surfaces						
Item		Legend	Class A Runway Requirement		Class B Runway Requirement	Remarks
No.	Description		VFR	IFR	VFR and IFR	
15	Width of approach-departure surface at end of horizontal portion	D	N/A	4,876.80 m (16,000 ft)	4,876.80 m (16,000 ft)	Centered along the runway centerline extended.
16	Elevation of horizontal portion of approach-departure surface	D	N/A	152.40 m (500 ft)	152.40 m (500 ft)	Above the established airfield elevation.
17	Radius of inner horizontal surface	E	N/A	2,286.00 m (7,500 ft)		An imaginary surface constructed by scribing an arc with a radius of 2,286 m (7,500 ft) about the centerline at each end of each runway and inter-connecting these arcs with tangents.
18	Width between outer edges of inner horizontal surface	E	N/A	4,572.00 m (15,000 ft)		
19	Elevation of inner horizontal surface	E	N/A	45.72 m (150 ft)		Above the established airfield elevation. See Attachment 1 for the definitions of "airfield elevation" and "inner horizontal surface." For Navy, also see UFC 2-000-05N.
20	Horizontal width of conical surface	F	N/A	2,133.60 m (7,000 ft)		Extends horizontally outward from the outer boundary of the inner horizontal surface.
21	Slope of conical surface	F	N/A	20:1		Slope ratio is horizontal:vertical. Example: 20:1 is 20 m (ft) horizontal to 1 m (ft) vertical
22	Elevation of conical surface at start of slope	F	N/A	45.72 m (150 ft)		Above the established airfield elevation.

Table 3-7. Airspace Imaginary Surfaces						
Item		Legend	Class A Runway Requirement		Class B Runway Requirement	Remarks
No.	Description		VFR	IFR	VFR and IFR	
23	Elevation of conical surface at end of slope	F	N/A	152.40 m (500 ft)		Above the established airfield elevation.
24	Distance to outer edge of conical surface	G	N/A	4,419.60 m (14,500 ft)		
25	Width of outer horizontal surface	G	N/A	9,144.00 m (30,000 ft)		Extending horizontally outward from the outer periphery of the conical surface.
26	Elevation of outer horizontal surface	G	N/A	152.40 m (500 ft)		Above the established airfield elevation.
27	Distance to outer edge of outer horizontal surface	G	N/A	13,563.60 m (44,500 ft)		An imaginary surface formed by scribing an arc with a radius of 13,563.6 m (44,500 ft) about the centerline at each end of each runway, and interconnecting the arcs with tangents.
28	Start of transitional surface	H	152.40 m (500 ft)		152.40 m (500 ft)	At Army airfields
			152.40 m (500 ft)		304.8 m (1,000 ft)	Air Force, Navy, and Marine Corps
29	End of transitional surface	H	See Remarks			The transitional surface ends at the inner horizontal surface, conical surface, outer horizontal surface, or at an elevation of 45.72 m (150 ft).
30	Slope of transitional surfaces	H	7:1			<p>Slope ratio is horizontal:vertical. 7:1 is 7 m (ft) horizontal to 1 m (ft) vertical.</p> <p>Vertical height of vegetation and other fixed or mobile obstacles and/or structures will not penetrate the transitional surface.</p> <p>Taxiing aircraft are exempt from this requirement.</p> <p>For Navy and Marine Corps airfields, taxiway pavements are exempt from this requirement.</p> <p>For the USAF, the Air Traffic Control Tower is exempt from this requirement if the height will not</p>

Table 3-7. Airspace Imaginary Surfaces						
Item		Legend	Class A Runway Requirement		Class B Runway Requirement	Remarks
No.	Description		VFR	IFR	VFR and IFR	
						affect TERPS criteria. See paragraph B16-2.7 and B16-4.3 of Appendix B, Section 16.

**NOTES:**

1. Approach-departure surfaces are based on instrument approach-departure procedures. Verify instrument approach-departure procedures with Army Aeronautical Service Agency, Air Force Flight Standard Agency, or Navy Flight Information Group (NAFIG), as appropriate, prior to using this table.
2. N/A = not applicable
3. Airfield and heliport imaginary surfaces and safe wingtip clearance dimensions are shown as a direct conversion from inch-pound to SI units.
4. Differences in elevation between the runway thresholds and the Established Airfield Elevation will have some effect on the extended length and width of the sloped portion of the ADCS and the start of the horizontal portion of the ADCS. Careful evaluation of these surfaces is required.

**3-15 AIRSPACE FOR AIRFIELDS WITH TWO OR MORE RUNWAYS.**

Typical airspace requirements for an airfield with multiple runways, such as a VFR and an IFR runway, are shown in Figure 3-19.

**3-16 OBSTRUCTIONS TO AIR NAVIGATION.**

An existing object (including a mobile object) is, and a future object would be, an obstruction to air navigation if it is higher than any of the heights or surfaces listed in FAR Part 77 and the surfaces described in this manual.

**3-16.1 Aircraft Operating Area (AOA).**

No part of the airfield (runway/taxiway aprons) where aircraft operate under their own power will be considered an obstruction if the applicable grading criteria are met. (See the glossary for the definition of "aircraft operating area," as used in this manual.)

**3-16.2 Determining Obstructions.**

For airfields located in the US and trust territories, an obstruction to air navigation is determined in accordance with this UFC and the standards contained in 14 Code of Federal Regulations (CFR) Part 77, Paragraph 77.23, "Standards for Determining Obstruction. For airfields located elsewhere, an obstruction is determined in accordance



with either the host county's standards, or the individual Service's standards, whichever are more stringent.

**3-16.3 Trees.**

All trees within the runway, taxiway and apron lateral clearance distances and within the graded area of the clear zone need to be removed. Trees that project into the imaginary surfaces must be removed or lowered to a distance below the imaginary surface, as specified in Table 3-8. Trees are permitted near an airfield provided that they do not cause Bird Aircraft Strike Hazards (BASH), penetrate the imaginary surfaces, the taxiway clearance distance, the apron clearance distance, or instrument procedure obstacle identification surfaces (OIS) as described in TERPS regulations.

**Table 3-8. Imaginary Surfaces Minimum Clearances over Highway, Railroad, Waterway, and Trees**

Table 3-8. Imaginary Surfaces Minimum Clearances			
Item		Traverse Way/Objects	Class A and Class B Runways
No.	Description		Dimensions
1	Minimum vertical clearance between established imaginary surfaces and traverse ways/objects (measured from the highest and nearest elevation of the traverse ways/objects)	Interstate highway that is part of the National System of Military and Interstate Highways	5.18 m (17 ft)
2		Other public highways not covered in Item 1	4.57 m (15 ft)
3		Private or military road	3.05 m (10 ft) minimum or height of highest mobile object that would usually traverse them, whichever is greater
4		Railroad	7.01 m (23 ft)
5		Waterway or traverse way, not previously covered	A distance equal to the height of the highest mobile object that usually would traverse them
6		Trees*	3 m (10 ft)

\* Trees must be removed or topped the distance shown below the applicable imaginary surface.

### **3-17 AIRCRAFT ARRESTING SYSTEMS.**

Aircraft arresting systems consist of engaging devices and energy absorbers. Engaging devices are net barriers, disc-supported pendants (hook cables), and cable support systems that allow the pendant to be raised to the battery position or retracted below the runway surface. Energy-absorbing devices are ships' anchor chains, textile brake arresting systems, rotary friction brakes, such as the BAK-9 and BAK-12, or rotary hydraulic systems such as the BAK-13 and E-28. The systems designated "Barrier, Arresting Kit" (BAK) are numbered in the sequence of procurement of the system design. There is no connection between the Air Force designations of these systems and their function. The equipment is government-furnished equipment, as discussed in AFI 32-1043. Other designations such as E-5, E-28, and M-31 are US Navy designations. These USAF systems are currently in use: MA-1A, E-5, BAK-12, BAK-14, 61QSII (BAK-15), mobile aircraft arresting system (MAAS), textile brake, and Type H hook cable retraction system.

#### **3-17.1 Navy and Marine Corps Requirements.**

Navy and Marine Corps unique requirements are identified where appropriate. In general, the Navy and Marine Corps use aircraft arresting gear design criteria consistent with requirements identified here.

#### **3-17.2 Installation Design and Repair Considerations.**

For the USAF, further information on planning, installing, and repairing an arresting system or arresting system complex is provided in AFI 32-1043 and FC 3-260-18F. During the planning, installation, or repair process, consider the items in paragraphs 3-17.2.1 through 3-17.2.3.

##### **3-17.2.1 Configuration and Location.**

The configuration and location of arresting system installations will be determined in accordance with FC 3-260-18F. Design will conform to the criteria in section 3 of the appropriate 35E8 series technical order and the typical installation drawings. Both may be obtained from:

AFLCMC/WNZEC  
ATTN: Aircraft Arresting Systems Engineer  
235 Byron St  
Robins AFB GA 31098-1813  
or the AFLCMC/WNZ Workflow Box at:  
[642CBSG.Workflow@us.af.mil](mailto:642CBSG.Workflow@us.af.mil)

##### **3-17.2.2 Runway Pavement.**

The 60 m (200 ft) of pavement on both the approach and departure sides of the arresting system pendant is a critical area. Protruding objects and undulating surfaces are detrimental to successful tailhook engagements and are not allowable. The

maximum permissible longitudinal surface deviation in this area is plus or minus 3 mm (0.125 in) in 3.6 m (12 ft). Saw-cut grooves in runway pavement to improve surface drainage and surface friction characteristics in accordance with UFC 3-260-02 are not considered protruding objects or undulations; however, the pavement will not be grooved within the first 3 m (10 ft) on either side of the arresting system cables. For USAF facilities, changes in pavement type or an interface between rigid and flexible pavements are not permitted within the center 22.86 m (75 ft) of the runway for 60 m (200 ft) in either direction from the arresting system cables. Sacrificial panels installed beneath arresting system cables in accordance with AFI 32-1043 are not considered a change in pavement type or an interface between rigid and flexible pavements. The prohibition on changes in surface pavement type is not applicable to emergency aircraft arresting systems located in overruns. Portland cement concrete (PCC) foundations designed in accordance with USAF Typical Installation Drawing 67F2013A are required for aircraft arresting system cable tie-downs and are also exempt from the prohibition on changes in surface pavement type. Navy aircraft arresting gear pavement protection will be designed in accordance with NAVFAC Standard Design Drawing numbers 4568319 through 4568322. The 2 m (6.56 ft) of pavement on both the approach and departure sides of the pendant are the critical areas for the Navy and Marine Corps. For Navy and Marine Corps runways, use a runway transverse slope of 0.75% for the center 2 slabs (for PCC) or twice the paving machine width (for asphalt concrete) but less than the center 6 m (20 feet), and 1% to 1.5% for the remainder of the runway section for at least 90 m (300 feet) in either longitudinal direction from the arresting gear cable.

### **3-17.2.3 Repair of Bituminous Pavements.**

Rigid inlays will not be used as a surface repair material beneath the cable in a flexible runway system. This type of repair causes high hook skip potential when the flexible pavement consolidates, exposing the leading edge of the rigid pavement. Rigid pavement must be used, however, as a foundation for sacrificial pads installed beneath aircraft arresting system cables. No part of the foundation for the panels will be used as a surface pavement in a flexible runway pavement.

### **3-17.3 Joint-Use Airfields.**

Arresting systems installed on joint-use civil/military airfields to support military aircraft are sited in accordance with FAA AC 150/5220-9 at [https://www.faa.gov/airports/resources/advisory\\_circulars/](https://www.faa.gov/airports/resources/advisory_circulars/).

#### **3-17.3.1 Agreement to Install.**

When planning the installation of an arresting system at a joint-use facility, the installation commander must first notify the airport manager/authority of the need. If the agreement is mutual, the installation commander submits the plan with sketches or drawings to the Air Force Liaison Officer in the appropriate FAA regional office. Disagreement between the responsible officials must be referred to the next higher level for resolution.

### **3-17.3.2 Disagreements.**

If a lease agreement is involved and does not allow placement of additional structures on the leased premises, the issue will be elevated to the MAJCOM for resolution.

### **3-17.3.3 Operating Agency.**

When an arresting system is installed at a joint-use civil airfield for the primary use of US military aircraft, the FAA acts for, and on behalf of, the DoD Service component in operating this equipment.

### **3-17.3.4 Third-Party Claims.**

Third-party claims presented for damage, injury, or death resulting from the FAA operation of the system for military aircraft or from DoD maintenance of the system is the responsibility of the DoD and must be processed under the appropriate DoD component's regulatory guidance.

### **3-17.3.5 DoD and FAA Agreements.**

Separate agreements between the DoD and the FAA are not required concerning liability for damage arising from the intentional operation of the system by FAA personnel for civil aircraft because such claims are the responsibility of the FAA.

### **3-17.3.6 Operational Agreement.**

The MAJCOM is responsible for negotiating the operational agreement with the FAA for a joint-use civil airport; however, authority may be delegated to the installation commander. The agreement will describe FAA functions and responsibilities concerning the remote control operation of arresting systems by FAA air traffic controllers.

### **3-17.4 Military Rights Agreements for Non-CONUS Locations.**

These systems are installed under the military rights agreement with the host government. If a separate agreement is specifically required for installation of a system, the installation commander coordinates with the local US diplomatic representative and negotiates the agreement with the host nation.

## CHAPTER 4 ROTARY-WING RUNWAYS, HELIPADS, LANDING LANES, AND HOVERPOINTS

### 4-1 CONTENTS.

This chapter presents design standards and requirements for rotary-wing (helicopter) landing facilities: runways, helipads, helicopter landing lanes, and hoverpoints.

### 4-2 LANDING AND TAKEOFF LAYOUT REQUIREMENTS.

The landing design requirements for rotary-wing landing facilities, which include rotary-wing runways, helipads, landing lanes, slide areas (autorotation lanes), and hoverpoints, are similar to the requirements for fixed-wing runways as discussed in Chapter 3.

### 4-3 ROTARY-WING RUNWAY.

The rotary-wing runway allows for a helicopter to quickly land and roll to a stop, compared to the hovering stop used during a vertical helipad approach.

#### 4-3.1 Orientation and Designation.

Consider the strength, direction, and frequency of the local winds when orienting a runway to minimize crosswinds. Follow the methods in Chapter 2 for rotary-wing runway orientation. Follow the guidance in Chapter 3, Paragraph 3-7 for determining rotary-wing runway designation. Runways are identified by the whole number, nearest one-tenth (1/10), of the magnetic azimuth of the runway centerline when viewed from the direction of approach.

#### 4-3.2 Dimensions.

Table 4-1 presents dimensional criteria for the layout and design of rotary-wing runways.

#### 4-3.3 Layout.

The layout for rotary-wing runways, including clear zones, are illustrated in Figure 4-1 for VFR runways and Figures 4-2 and 4-3 for IFR runways.

#### 4-3.4 Special Tilt-Rotor Aircraft Considerations (V-22).

The V-22 is a tilt-rotor aircraft that can operate both as a fixed-wing aircraft or a rotary-wing aircraft. When the V-22 operates on rotary-wing facilities, this chapter applies with noted V-22 exceptions. See paragraph 1-2.2.4 for general V-22 planning considerations.

Table 4-1. Rotary-Wing Runways

Table 4-1. Rotary-Wing Runways			
Item		Requirement	Remarks
No.	Description		
1	Basic length	490 m (1,600 ft)	For Army and Air Force facilities, use basic length up to 1,220 m (4,000 ft) in elevation above mean sea level (AMSL). Increase basic length to 610 m (2,000 ft) when above 1,220 m (4,000 ft) in elevation above MSL.  For Navy and Marine Corps facilities, basic length to be corrected for elevation and temperature. Increase 10% for each 300 m (1,000 ft) in elevation above 600 m (2,000 ft) MSL and add 4.0% for each 5 degrees C (10 degrees F), above 15 degrees C (59 degrees F) for the average daily maximum temperature for the hottest month.  For a special mission or proficiency training such as autorotation operations, the length may be increased up to 300 m (1,000 ft); in that case, make no additive corrections.
		137.2 m (450 ft)	For facilities constructed prior to May 1999.
2	Width	23 m (75 ft)	For Navy and Marine Corps facilities, increase width to 30 m (100 ft) on runways which regularly accommodate H-53 and V-22.
3	Longitudinal grade	Max. 1.0%	Maximum longitudinal grade change is 0.167% per 30 linear meters (100 linear feet) of runway. Exceptions: 0.4% per 30 linear meters (100 linear feet) for edge of runways at runway intersections.
4	Transverse grade	Min. 1.0% Max. 1.5%	From centerline of runway. Runway may be crowned or cross-sloped.
5	Paved shoulders		See Table 4-4.
6	Runway lateral clearance zone (corresponds to half the width of primary surface area)	45.72 m (150 ft)	VFR operations
		114.30 m (375 ft)	IFR operations
		See Remarks	Measured perpendicularly from centerline of runway. This area is to be clear of fixed and mobile obstacles. In addition to the lateral clearance criterion, the vertical height restriction on structures and parked aircraft as a result of the transitional slope must be taken into account. (1) Fixed obstacles include man-made or natural features constituting possible hazards to moving aircraft. Navigational aids and meteorological equipment are possible exceptions. For Army and Air Force, siting exceptions for navigational aids and meteorological facilities are provided in Appendix B, Section 13, of this manual. For Navy and Marine Corps, siting exceptions for navigational aids and meteorological facilities are found in paragraph 2-11. (2) Mobile obstacles include parked aircraft, parked and moving vehicles, railroad cars and similar equipment. (3) Taxiing aircraft are exempt from this restriction. However, parallel taxiways (exclusive of shoulder width) must be located in excess of the lateral clearance distance.
7	Grades within the primary	Min. 2.0% Max. 5.0%	Exclusive of pavement and shoulders.

Table 4-1. Rotary-Wing Runways

Table 4-1. Rotary-Wing Runways			
Item		Requirement	Remarks
No.	Description		
	surface area in any direction		
8	Overrun		See Table 4-5.
9	Distance from the centerline of a fixed-wing runway to the centerline of a parallel rotary-wing runway, helipad, or landing lane	Min. 213.36 m (700 ft)	Simultaneous VFR operations for Class A runway and Army Class B runway
		Min. 304.80 m (1,000 ft)	Simultaneous VFR operations for Class B Runway for Air Force, Navy and Marine Corps.
		Min. 213.36 m (700 ft)	Non-simultaneous VFR and IFR operations. Distance may be reduced to 60.96 m (200 ft); however, waiver is required. Ensure waiver includes evaluation of effects of wake-turbulence and jet blast. In locating the helipad, the helipad must be sited beyond the runway hold line.
		Min. 762.00 m (2,500 ft)	IFR using simultaneous operations (depart-depart) (depart-approach).
		Min. 1,310.64 m (4,300 ft)	IFR using simultaneous approaches.
10	Distance between centerlines of: (a) parallel rotary-wing runways, helipads, or any combination thereof; (b) landing lane and parallel rotary-wing runway or helipad	Min. 213.36 m (700 ft)	VFR without intervening parallel taxiway between centerlines. For US Army, distance may be reduced to 60.96 m (200 ft) between parallel helipads for non-simultaneous operations.  For V-22, may be reduced to 121.9 m (400 ft) offset, centerline to centerline, for non-simultaneous operations  In locating the helipad, consideration must be given to hold position marking.
		Min. 762.00 m (2,500 ft)	IFR using simultaneous operations (depart-depart) (depart-approach).
		Min. 1,310.64 m (4,300 ft)	IFR using simultaneous approaches.

**NOTES:**

1. Metric units apply to new airfield construction and, where practical, modification to existing airfields and heliports, as discussed in paragraph 1-3.4.
2. The criteria in this manual are based on aircraft specific requirements and are not direct conversions from inch-pound (English) dimensions. Inch-pound units are included only as a reference to the previous standard.
3. Airfield and heliport imaginary surfaces and safe wingtip clearance dimensions are shown as a direct conversion from inch-pound to SI units.

Figure 4-1. Helicopter VFR Runway

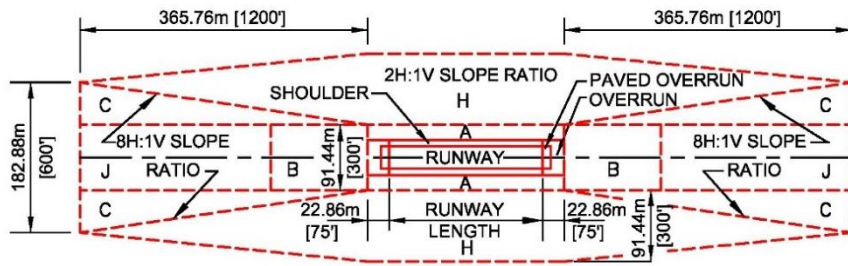

PLAN  
N.T.S.

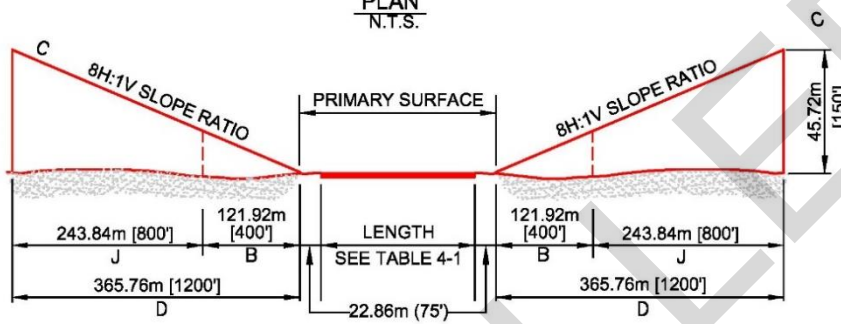

LONGITUDINAL PROFILE  
N.T.S.

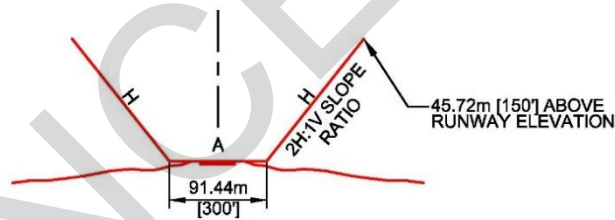

TRANSVERSE SECTION  
N.T.S.

NOTES

1. APPROACH-DEPARTURE CLEARANCE SURFACE (C), CLEAR ZONES (B), AND APZ'S (J) APPLICABLE TO BOTH ENDS OF THE RUNWAY.

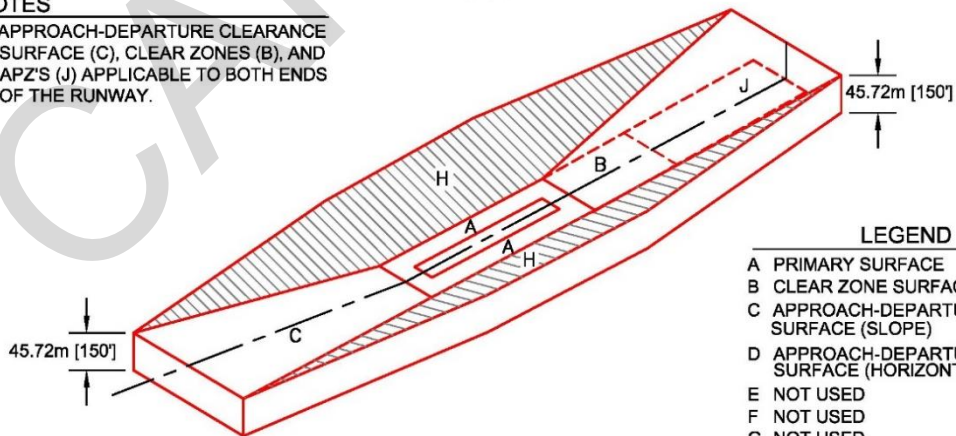

ISOMETRIC  
N.T.S.

LEGEND

- A PRIMARY SURFACE
- B CLEAR ZONE SURFACE
- C APPROACH-DEPARTURE CLEARANCE SURFACE (SLOPE)
- D APPROACH-DEPARTURE CLEARANCE SURFACE (HORIZONTAL)
- E NOT USED
- F NOT USED
- G NOT USED
- H TRANSITIONAL SURFACE
- I NOT USED
- J ACCIDENT POTENTIAL ZONE (APZ)



Figure 4-2. Helicopter IFR Runway

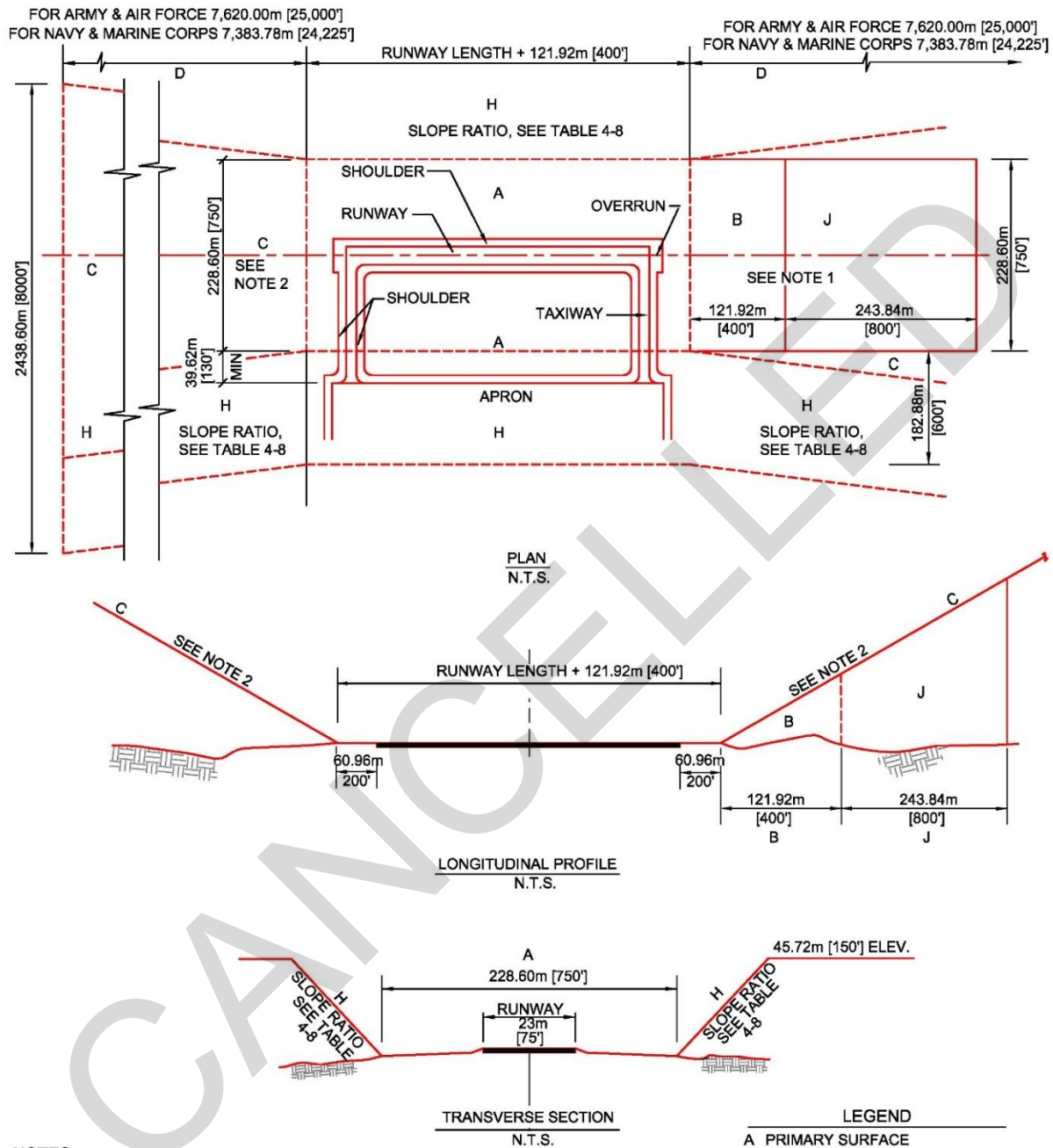

**NOTES**

1. CLEAR ZONE AND APZ TYPICAL AT BOTH ENDS OF RUNWAY.
2. APPROACH-DEPARTURE CLEARANCE SURFACE SLOPE RATIO IS 34H:1V FOR ARMY AND AIR FORCE AND 25H:1V FOR NAVY AND MARINE CORPS

**LEGEND**

- A PRIMARY SURFACE
- B CLEAR ZONE SURFACE
- C APPROACH-DEPARTURE CLEARANCE SURFACE (SLOPE)
- D APPROACH-DEPARTURE CLEARANCE SURFACE (HORIZONTAL)
- E NOT SHOWN
- F NOT USED
- G NOT USED
- H TRANSITIONAL SURFACE
- I NOT USED
- J ACCIDENT POTENTIAL ZONE (APZ 1)

Figure 4-3. IFR Airspace Imaginary Surfaces: IFR Helicopter Runway and Helipad

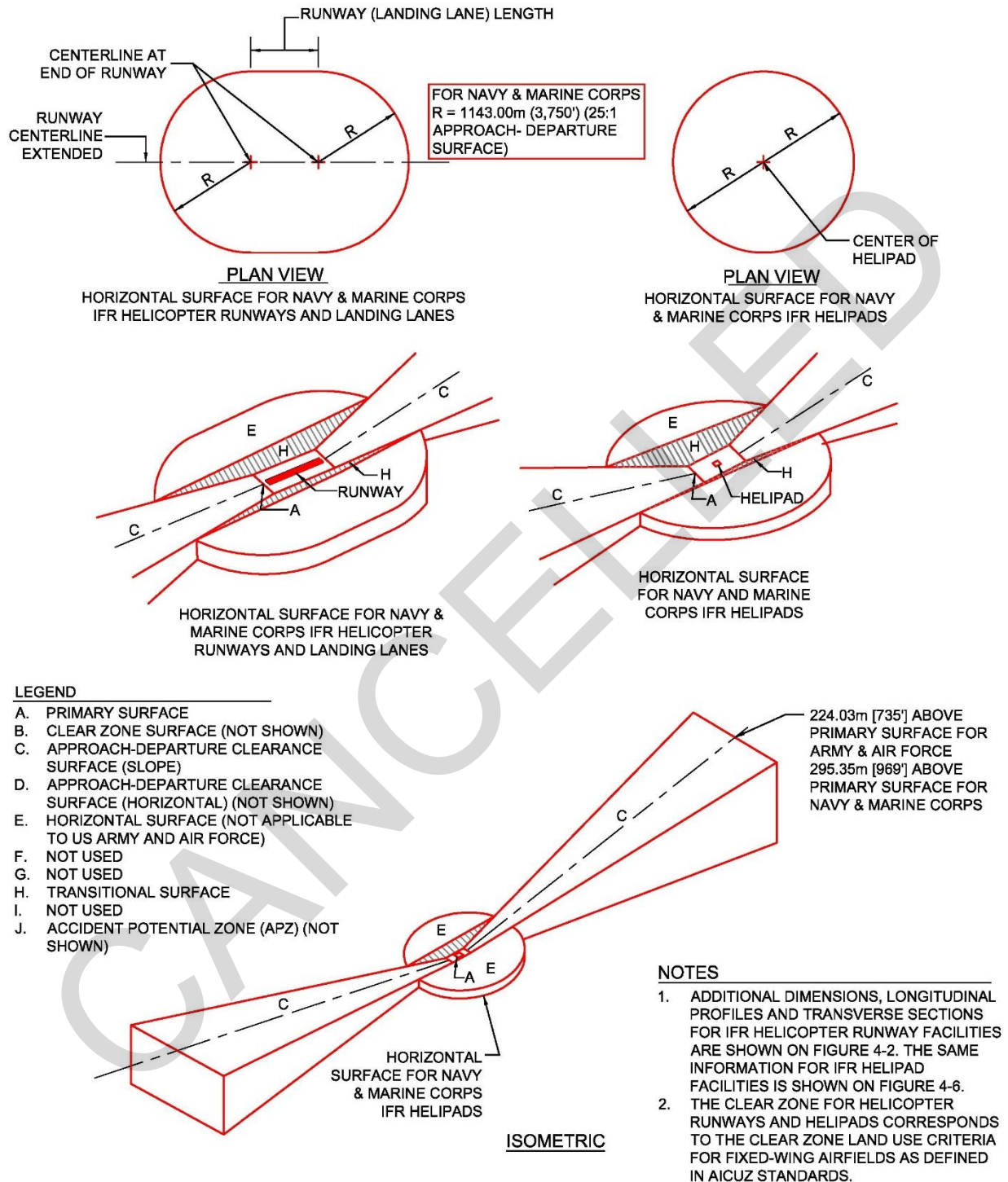

## **4-4 HELIPADS.**

Helipads allow for a helicopter hovering, landing, and takeoff. Except at facilities where helicopter runways are provided, helipads are the landing and takeoff locations for helicopters. The Army and Air Force provide for four types of helipads: standard VFR helipad, limited use helipad, IFR helipad and elevated helipad. The Navy and Marine Corps provide only one type of helipad: standard size helipad. Use High Temperature Concrete and neoprene joint sealants in locations where stationary V-22 nacelle exhaust exposure is ten minutes or greater. See Chapter 8 for additional materials information. The type of helipad depends on these operational requirements:

### **4-4.1 Standard VFR Helipad.**

VFR design standards are used when no requirement exists or will exist in the future for an IFR helipad. Criteria for this type of helipad permit the accommodation of most helipad lighting systems.

### **4-4.2 Limited Use Helipad.**

This is a VFR rotary-wing facility for use only by observation, attack, medical evacuation and utility (OH, AH, HH, and UH) helicopters. These type of helipads support only occasional operations at special locations such as hospitals, headquarters facilities, missile sites, and other similar locations. Limited use helipads may be located on airfields where one or more helipads are required to separate OH, AH, HH and UH traffic from other helicopter traffic or fixed-wing traffic.

### **4-4.3 IFR Helipad.**

IFR design standards are used when an instrument approach capability is essential to the mission and no other instrument landing facilities, either fixed-wing or rotary-wing, are located within an acceptable commuting distance to the site.

### **4-4.4 Elevated Helipad.**

This is a facility that has a helipad elevated above ground level on a building roof top or another structure built specifically for the pad (a ground level helipad with the pad on a mound is not an elevated helipad). For Army, elevated helipads require approval of USAASA. For Navy and Marine Corps facilities, contact the agency aviation office with safety waiver approval authority.

### **4-4.5 Helipad Location.**

A helipad location should be selected with regard to mission requirements, overall facility development, approach-departure surfaces, and local wind conditions.

#### **4-4.5.1 Near Runways.**

When a helipad is to be located near fixed- and rotary-wing runways, its location should be based on the type of operations in accordance with the criteria in Table 4-1.

**4-4.5.2 Standby Parking Pads.**

Where it is necessary to have one or more helicopters on standby, an area adjacent to the helipad but clear of the landing approach and transitional surfaces should be designated for standby parking. This area will be designed as a parking apron in conformance with the criteria in Chapter 6.

**4-4.6 Dimensional Criteria.**

Table 4-2 presents dimensional criteria for the layout and design of helipads and hoverpoints.

**Table 4-2. Rotary-Wing Helipads and Hoverpoints**

<b>Table 4-2. Rotary-Wing Helipads and Hoverpoints</b>			
<b>Item</b>		<b>Requirement</b>	<b>Remarks</b>
<b>No.</b>	<b>Description</b>		
1	Size	30 m x 30 m (100 ft x 100 ft) min.	Standard VFR and IFR helipad – Army, Air Force and Navy including all V-22
		15 m x 15 m (50 ft x 50 ft) min.	Limited use VFR helipad – Army and Air Force
		17 m x 17 m (55 ft x 55 ft)	Elevated Army and Air Force Helipads UH-60 or smaller helicopters
		30 m x 30 m (100 ft x 100 ft)	CH-47 and larger helicopters
		9 m (30 ft) diameter	Hoverpoints
2	Grade	Min. 1.0% Max. 1.5%	Grade helipad in one direction. Hoverpoints should be domed to a 150-mm (6-in) height at the center.
3	Paved shoulders		See Table 4-4.
4	Size of primary surface (center primary surface on helipad)	91.44 m x 91.44 m (300 ft x 300 ft)	Air Force and Army standard VFR helipad, including all V-22 IFR
		45.72 m x 45.72 (150 ft x 150 ft) min.	Air Force and Army limited use VFR helipad  Navy and Marine Corps Standard VFR helipad  Hoverpoints
		472.44 m x 228.60 m (1,550 ft x 750 ft)	Standard IFR. Long dimension in direction of helicopter approach.
		228.60 m x 228.60 m (750 ft x 750 ft)	Army and Air Force IFR same direction ingress/egress.
			Elevated Army and Air Force Helipads

Table 4-2. Rotary-Wing Helipads and Hoverpoints			
Item		Requirement	Remarks
No.	Description		
		59.44 m x 59.44 m (195 ft x 195 ft)	UH-60 or smaller helicopters
		91.44 m x 91.44 m (300 ft x 300 ft)	CH-47 and larger helicopters
5	Grades within the primary surface area in any direction	Min. of 2.0% prior to channelization.* Max. 5.0%	<p>Exclusive of pavement and shoulders.</p> <p>For IFR helipads, the grading requirements apply to a 91.44 m X 91.44 m (300 ft X 300 ft) area centered on the helipad. The balance of the area is to be clear of obstructions and rough graded to the extent necessary to reduce damage to aircraft in event of an emergency landing.</p> <p>For VFR helipads, the grade requirements apply to the entire primary surface.</p> <p>For elevated helipads, no obstacles may penetrate the elevation of the primary surface.</p>
6	Length of clear zone**/protection zone	121.92 m (400 ft)	Hoverpoints, VFR, and standard IFR helipads. Begins at the end of the primary surface.
		251.46 m (825 ft)	Army and Air Force IFR same direction ingress/egress.
		335.28 m (1,100 ft)	V-22 IFR helipad.
7	Width of clear zone**/protection zone		Corresponds to the width of the primary surface. Center clear zone width on extended center of the pad.
		45.72 m (150 ft)	Air Force and Army VFR limited use helipads and hoverpoints.  Navy and Marine Corps Standard VFR. See OPNAVINST 11010.16 (or latest version) for additional guidance.
		91.44 m (300 ft)	Air Force and Army standard VFR helipad and VFR helipad same direction ingress/egress.
		228.60 m (750 ft)	Standard IFR and V-22 IFR helipad

Table 4-2. Rotary-Wing Helipads and Hoverpoints			
Item		Requirement	Remarks
No.	Description		
		59.44m (195 ft) at start of Protection Zone expanding to 89.92m (295 ft) at end of Protection Zone	Elevated Army and Air Force Helipads UH-60 or smaller helicopters
		91.44m (300 ft) at start of Protection Zone expanding to 121.92m (400 ft) at end of Protection Zone	CH-47 and larger helicopters
8	Grades of clear zone** any direction	5.0% max	Area to be free of obstructions. Rough grade and turf when required.
9	APZ I length***	243.84 m (800 ft)	Elevated helipads, Hoverpoints, VFR, and standard IFR helipads, including V-22 IFR helipads
		121.92 m (400 ft)	Army and Air Force IFR same direction ingress/egress
10	APZ I width***	45.72 m (150 ft)	Army and Air Force VFR limited use and hoverpoints; Navy and Marine Corps standard VFR
		91.44 m (300 ft)	Army and Air Force standard VFR
		228.60 m (750 ft)	Standard IFR and V-22 IFR helipad
		89.92 m (295 ft) 121.92 m (400 ft)	Elevated Army and Air Force Helipads UH-60 or smaller helicopters CH-47 or larger helicopters
11	Distance between centerline of helipad and fixed- or rotary-wing runways		See Table 4-1.

\* Bed of channel may be flat.

\*\* The clear zone area for helipads corresponds to the clear zone land use criteria for fixed-wing airfields as defined in DoD AICUZ standards. The remainder of the approach-departure zone corresponds to APZ I land use criteria similarly defined. APZ II criteria is not applicable for rotary-wing aircraft.

\*\*\* There are no grading requirements for APZ I.

**NOTES:**

1. Metric units apply to new airfield construction and, where practical, modification to existing airfields and heliports, as discussed in paragraph 1-3.4.
2. The criteria in this manual are based on aircraft specific requirements and are not direct conversions from inch-pound (English) dimensions. Inch-pound units are included only as a reference to the previous standard.
3. Airfield and heliport imaginary surfaces and safe wingtip clearance dimensions are shown as a direct conversion from inch-pound to SI units.

**4-4.7 Layout Criteria.**

Layouts for standard, limited use, and IFR helipads, including clear zones, are illustrated in Figures 4-8 through 4-10.

#### **4-5 SAME DIRECTION INGRESS/EGRESS.**

Helipads with same direction ingress/egress allow a helicopter pad to be located in a confined area where approach-departures are made from only one direction. The approach may be either VFR or IFR. For the USAF and Army, single direction ingress/egress VFR limited use helipads are configured as shown in Figure 4-12 using the criteria given in Tables 4-2 and 4-7.

##### **4-5.1 Dimensions Criteria.**

Table 4-2 presents dimensional criteria for VFR and IFR same direction ingress/egress helipads.

##### **4-5.2 Layout Criteria.**

Layout for VFR, VFR limited use, and IFR same direction ingress/egress helipads are illustrated in Figures 4-11, 4-12 and 4-13.

#### **4-6 HOVERPOINTS.**

##### **4-6.1 General.**

A hoverpoint is a prepared and marked surface used as a reference or control point for air traffic control purposes by arriving or departing helicopters.

##### **4-6.2 Dimensions.**

Table 4-2 presents dimensional criteria for the layout and design of hoverpoints. Layout. Hoverpoint design standards are illustrated in Figure 4-14.

#### **4-7 ELEVATED HELIPADS – ARMY AND AIR FORCE ONLY.**

##### **4-7.1 General.**

Elevating helipads 6 feet (1.8 m) or more above the level of the roof will generally minimize the turbulent effect of air flowing over the roof edge. While elevating the platform helps reduce or eliminate the air turbulence effects, a safety net may be required. Helipads should be constructed of metal or concrete. Surfaces should have a broomed pavement or other roughened finish that provides a skid-resistant surface for helicopters and non-slippery footing for people. The primary surface should be contained on the structure.

##### **4-7.2 Rooftop and Other Elevated Helipads.**

Elevated helipads and any supporting helipad structure should be capable of supporting the dynamic loads of the design helicopter in accordance with UFC 3-301-01, Structural Engineering. For UH-60 and smaller rotor diameter use 22,000 LB as the minimum aircraft weight for structural design. For CH-47, use 50,000 LB as the minimum aircraft weight for structural design. Use heavier design weight if mission aircraft is heavier than the minimum.

**4-7.3            Dimensions.**

Table 4-2 presents dimensional criteria for the layout and design of elevated helipads.

CANCELLED



Figure 4-4. Elevated Helipad Layout Criteria for UH-60 or Smaller Rotor Diameter Helicopters (8H:1V)

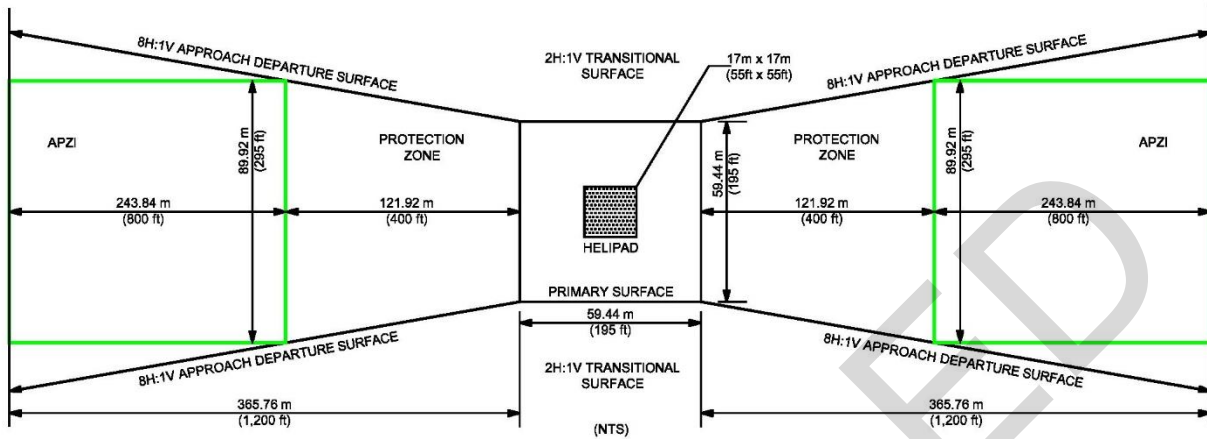
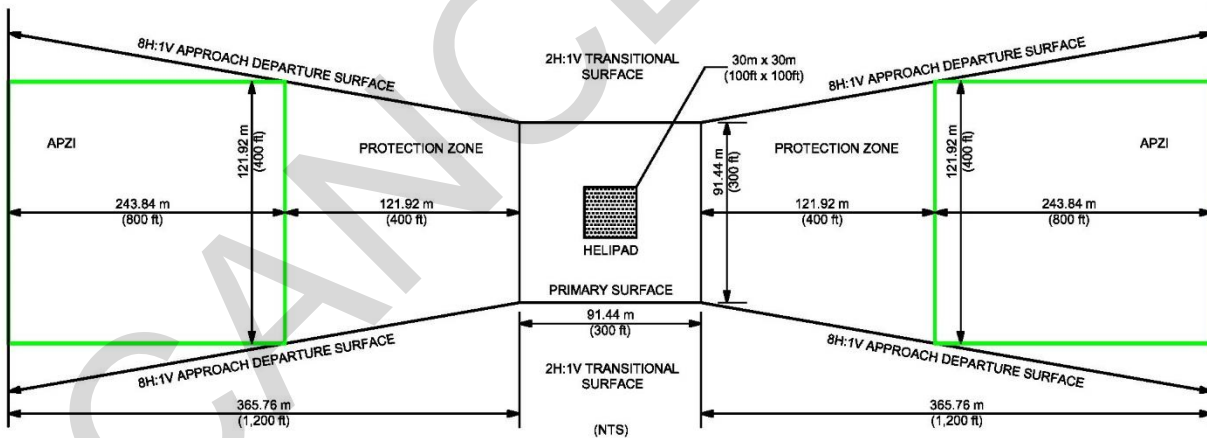
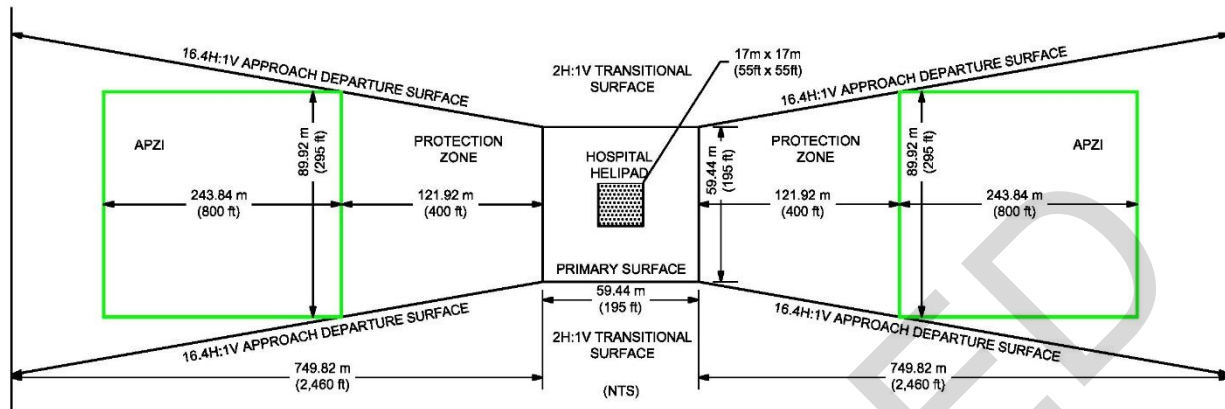

Figure 4-5. Elevated Helipad Layout Criteria for CH-47 and Larger Helicopters (8H:1V)



**Figure 4-6. Elevated Hospital Helipad Layout Criteria for UH-60 or Smaller Rotor Diameter Helicopters (16.4H:1V)**



**Figure 4-7. Elevated Hospital Helipad Layout Criteria for CH-47 and Larger Helicopters (16.4H:1V)**

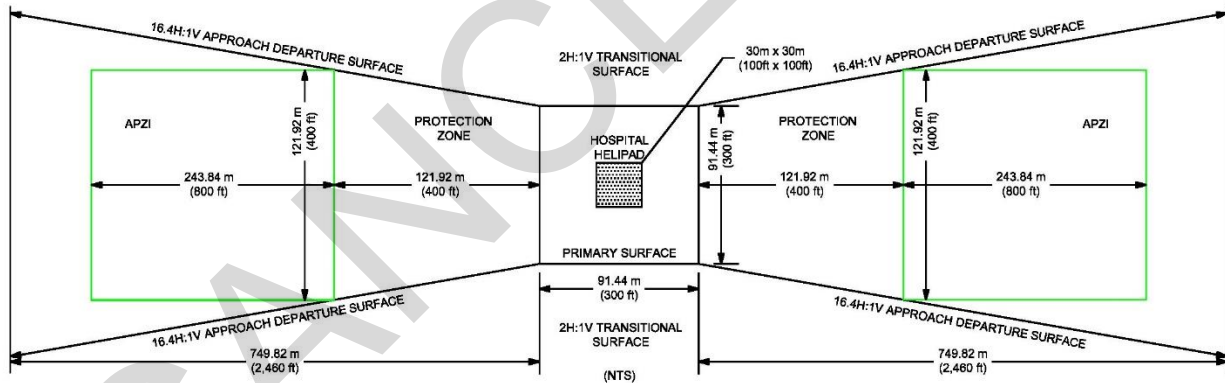

#### 4-7.4 Safety Net.

When the helipad is on a platform elevated more than 30 inches (76 cm) above its surroundings, a safety net, not less than 5 feet (1.5 m) wide, should be provided. A railing or fence should not be used since it would be a safety hazard during helicopter operations. The safety net should have a load carrying capability of 25 lb/ft<sup>2</sup> (122 kg/m<sup>2</sup>). The net should not project above the level of the helipad. Both the inside and outside edges of the safety net should be fastened to a solid structure.

#### 4-7.5 Access to Elevated Helipads.

OSHA requires two separate access points for an elevated structure such as an elevated helipad. Hospital heliports should provide access to and from the helipad via a ramp in order to provide for quick and easy transportation of a patient on a gurney. Ramps should be built in accordance with state and local requirements. The width of the ramp, and any turns in the ramp, should be wide enough to accommodate a gurney with a person walking on each side. Straight segments of the ramp should be not less than 6 feet (1.8 m) wide. Additional width may be required in the turns. The ramp surface should provide a slip-resistant surface. The slope of the ramp should be no steeper than 12:1 (12 unit horizontal in 1 units vertical). Inside the primary surface any handrails should not extend above the elevation of the helipad. Where a handrail complying with Appendix A of 49 CFR 37, Section 4.8, is not provided, other means should be provided to protect personnel from fall hazards.

#### **4-7.6 Fixed Objects within a Primary Surface.**

No fixed object shall be permitted within a primary surface or protection zone, except for frangibly mounted objects that, due to their function, must be located there.

#### **4-7.7 Obstructions.**

Elevator penthouses, cooling towers, exhaust vents, fresh-air vents, and other raised features can impact helipad operations. Helicopter exhausts can impact building air quality if the helipad is too close to fresh-air vents. These issues shall be resolved during facility design. In addition, control mechanisms should be established to ensure that obstruction hazards are not installed after the helipad is operational. Those objects whose functions require them to be located within these areas should be less than a height of 8 inches (20 cm), be frangible, and must not penetrate the approach/departure surfaces or transitional surfaces.

#### **4-7.8 Protection Zone.**

The protection zone takes the place of a clear zone for elevated helipads. It is an imaginary planar surface that starts at the elevation of the helipad and extends out 400'. The area underlying the protection zone has to be owned or controlled by the installation. All incompatible objects or facilities should be removed from this area. Incompatible facilities include, occupied structures, main entrances, other areas where people congregate, and facilities that might create smoke or steam that would obscure visibility."

#### **4-8 ROTARY-WING LANDING LANES.**

Except when used as an autorotation lane, these lanes permit efficient simultaneous use by a number of helicopters in a designated traffic pattern.

#### **4-8.1 Requirements for a Landing Lane.**

Occasionally at airfields or heliports, helicopters are parked densely on mass aprons. When this occurs, there is usually a requirement to provide landing and takeoff facilities that permit more numerous rapid launch and recovery operations than otherwise could be provided by a single runway or helipad. Increased efficiency can be attained by providing one or more of, but not necessarily limited to, these options:

- Multiple helipads or hoverpoints
- A rotary-wing runway of length in excess of the criteria in Table 4-1
- Helicopter landing lanes

#### **4-8.2 Landing Lane Location.**

Landing lanes are typically located in front of the paved apron on which the helicopters park, as shown in Figure 4-15.

#### **4-8.3 Touchdown Points.**

The location at which the helicopters are to touchdown on the landing lane are designated with 1.2m (4') x 1.8m (6') rectangular panel markings placed at equal intervals on the landing lane centerline not less than 400 feet apart.

#### **4-8.4 Dimensions.**

Table 4-3 presents dimensional criteria for the layout and design of rotary-wing landing lanes.

#### **4-8.5 Layout.**

A layout for rotary-wing landing lanes is illustrated in Figure 4-15.

Figure 4-8. Standard VFR Helipad for Army and Air Force

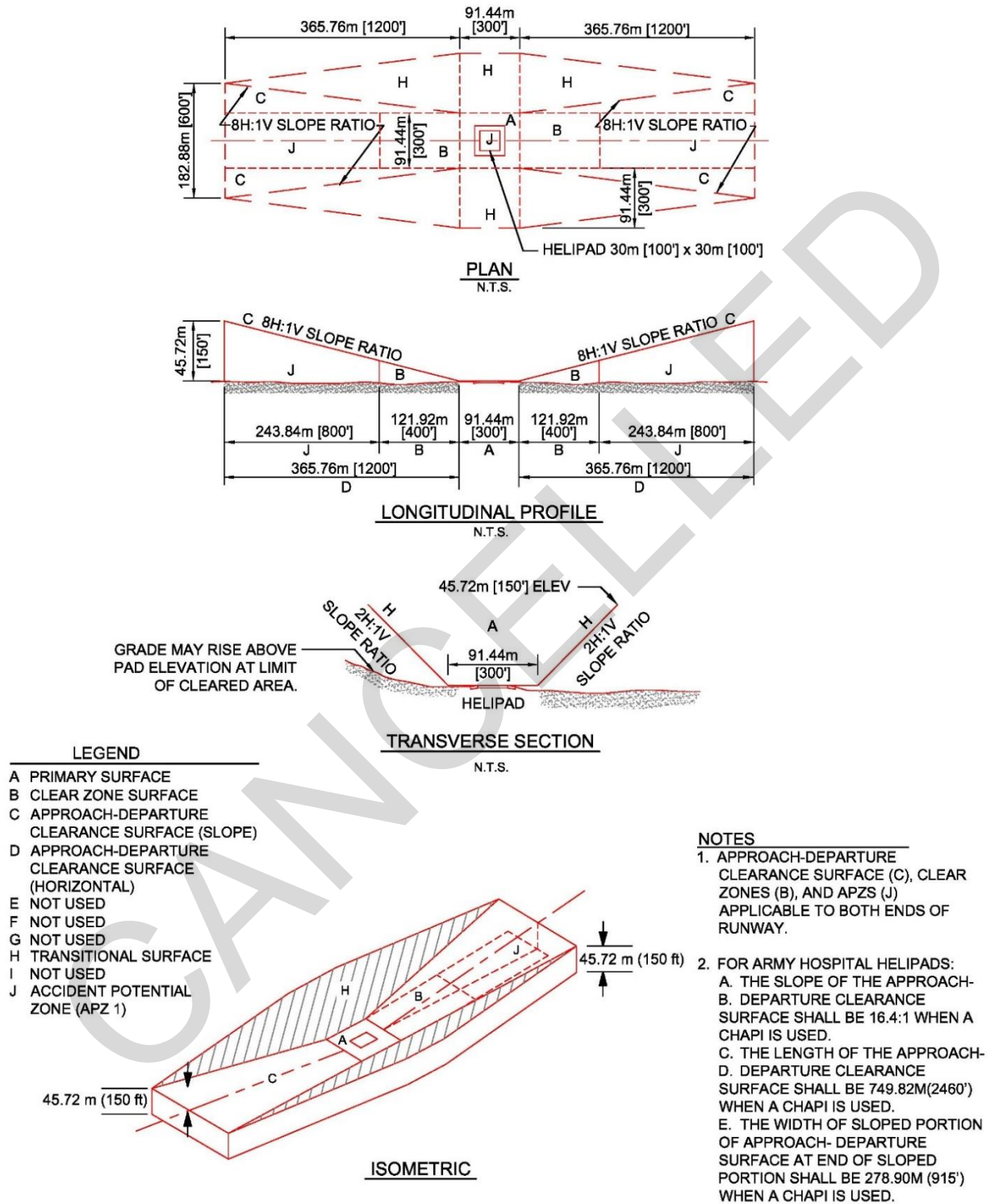

Figure 4-9 Standard VFR Helipad for Navy and Marine Corps and Limited Use VFR Helipad for Army and Air Force

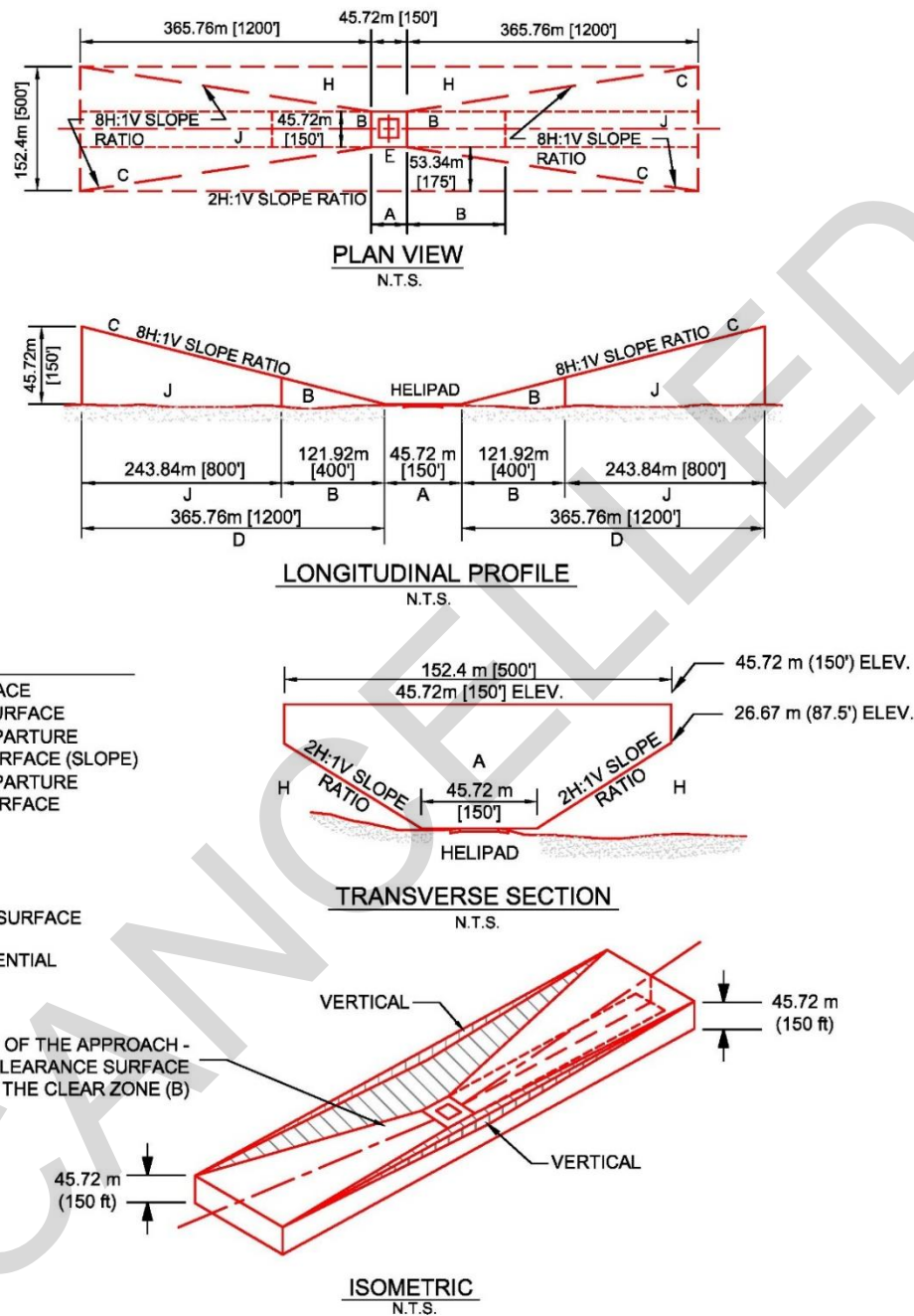
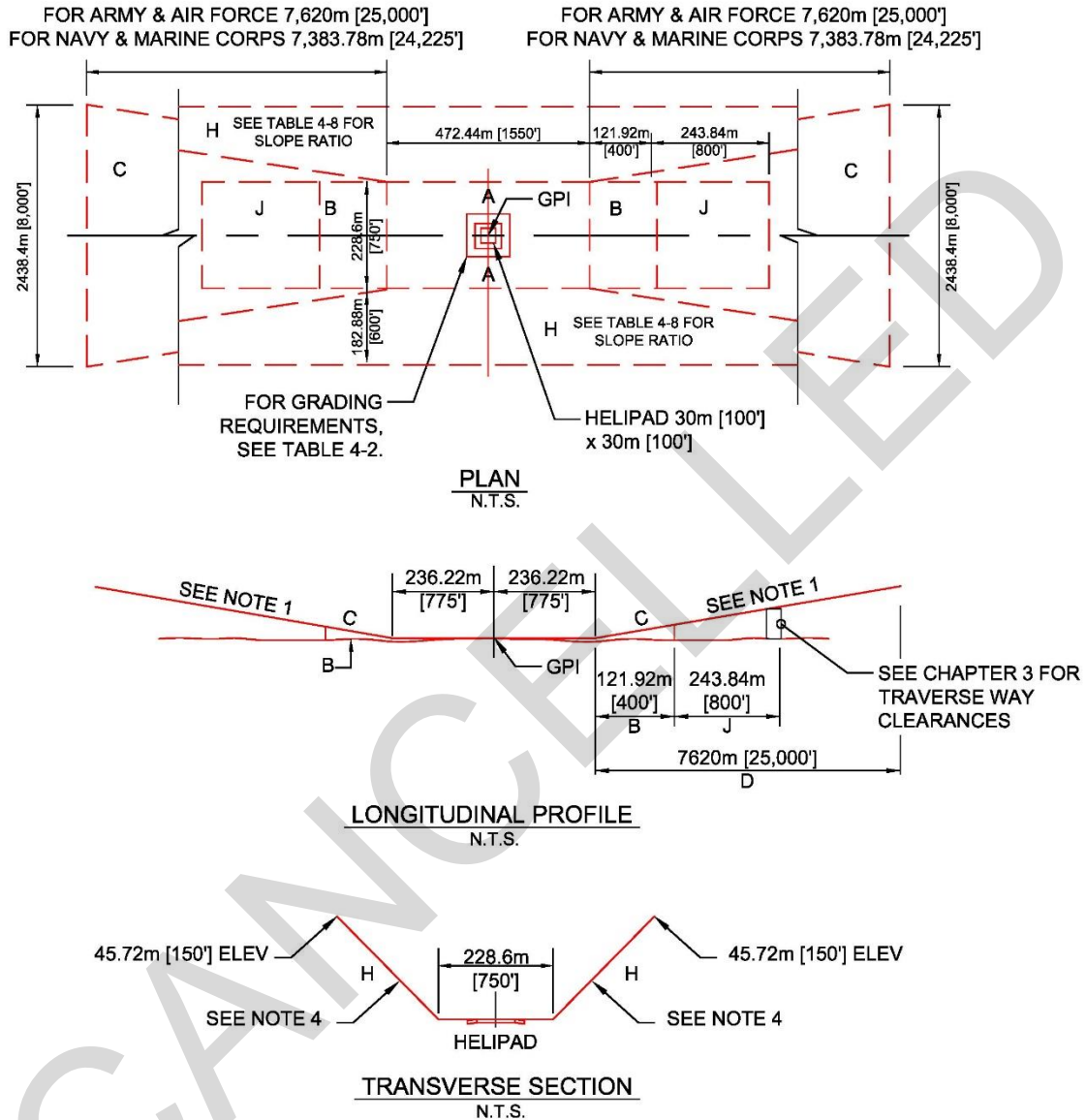

Figure 4-10. Standard IFR Helipad



**LEGEND:**

- A. PRIMARY SURFACE.
- B. CLEAR ZONE SURFACE.
- C. APPROACH-DEPARTURE CLEARANCE SURFACE (SLOPE) SEE NOTE 1.
- D. APPROACH-DEPARTURE CLEARANCE SURFACE (HORIZONTAL).
- E. INNER HORIZONTAL SURFACE (NOT SHOWN).
- F. NOT USED
- G. NOT USED
- H. TRANSITIONAL SURFACE
- I. NOT USED
- J. ACCIDENT POTENTIAL ZONE (APZ 1).

**NOTES:**

1. APPROACH-DEPARTURE CLEARANCE SURFACE SLOPE RATIO IS 34H:1V FOR ARMY AND AIR FORCE, AND 25H:1V FOR NAVY AND MARINE CORPS.
2. CLEAR ZONE AND APZ TYPICAL AT BOTH ENDS OF RUNWAY.
3. FOR ISOMETRIC, SEE FIGURE 4-3.
4. TRANSITIONAL SURFACE SLOPE RATIO IS 4H:1V.

Figure 4-11. Army, Air Force, Navy, and Marine Corps VFR Helipad with Same Direction Ingress/Egress

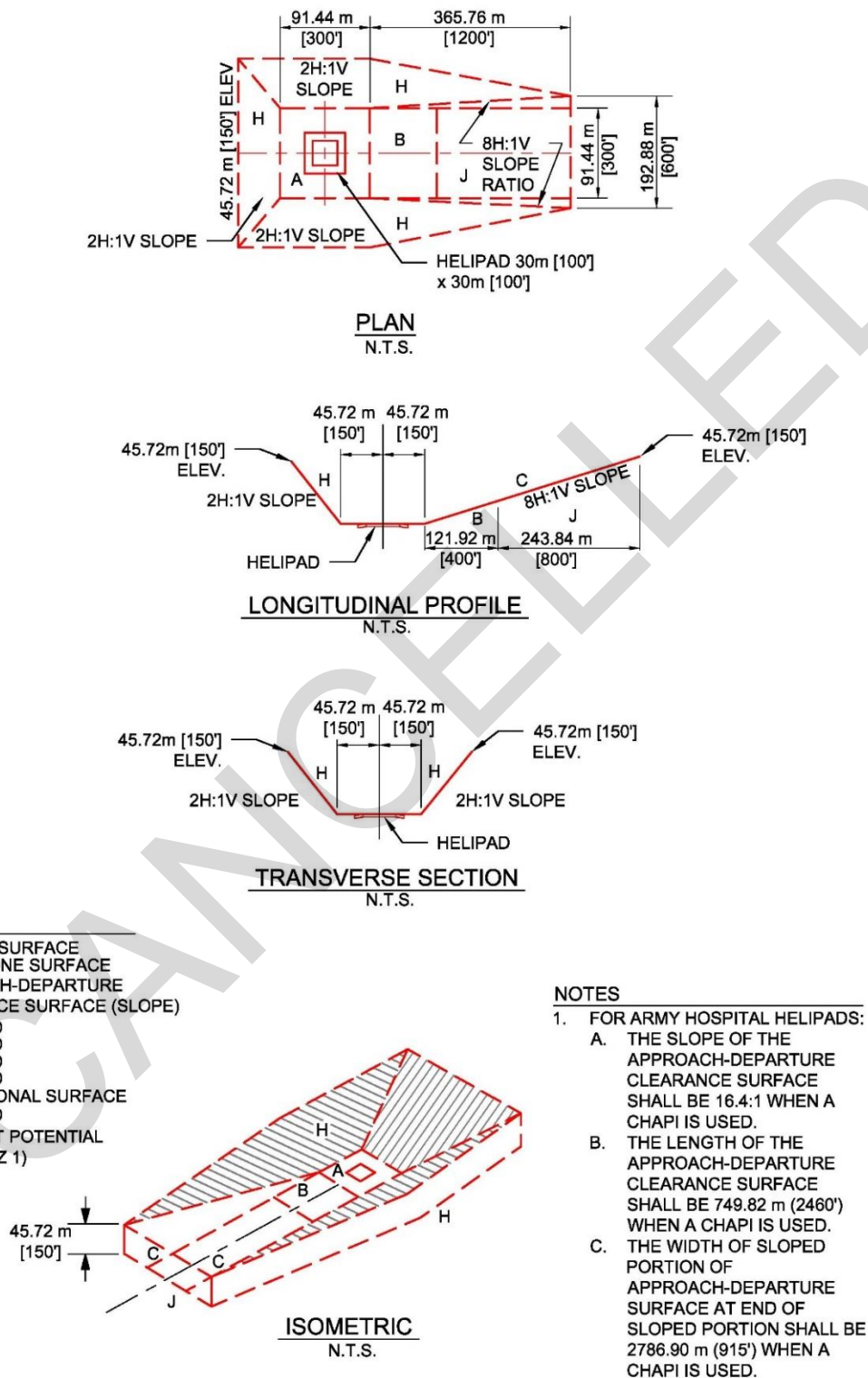



Figure 4-12. Army and Air Force VFR Limited Use Helipad with Same Direction Ingress/Egress

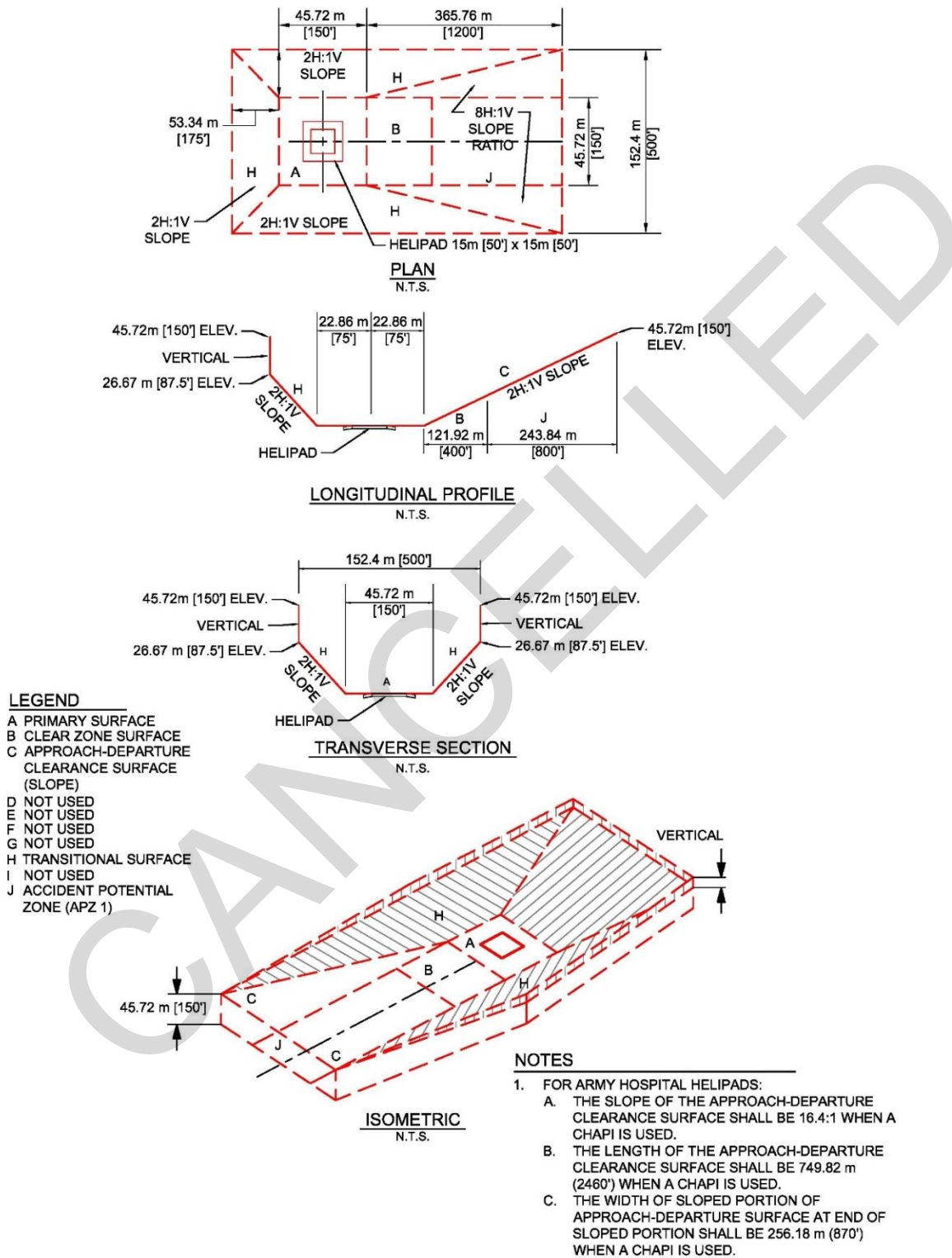

Figure 4-13. Army and Air Force IFR Helipad with Same Direction Ingress/Egress

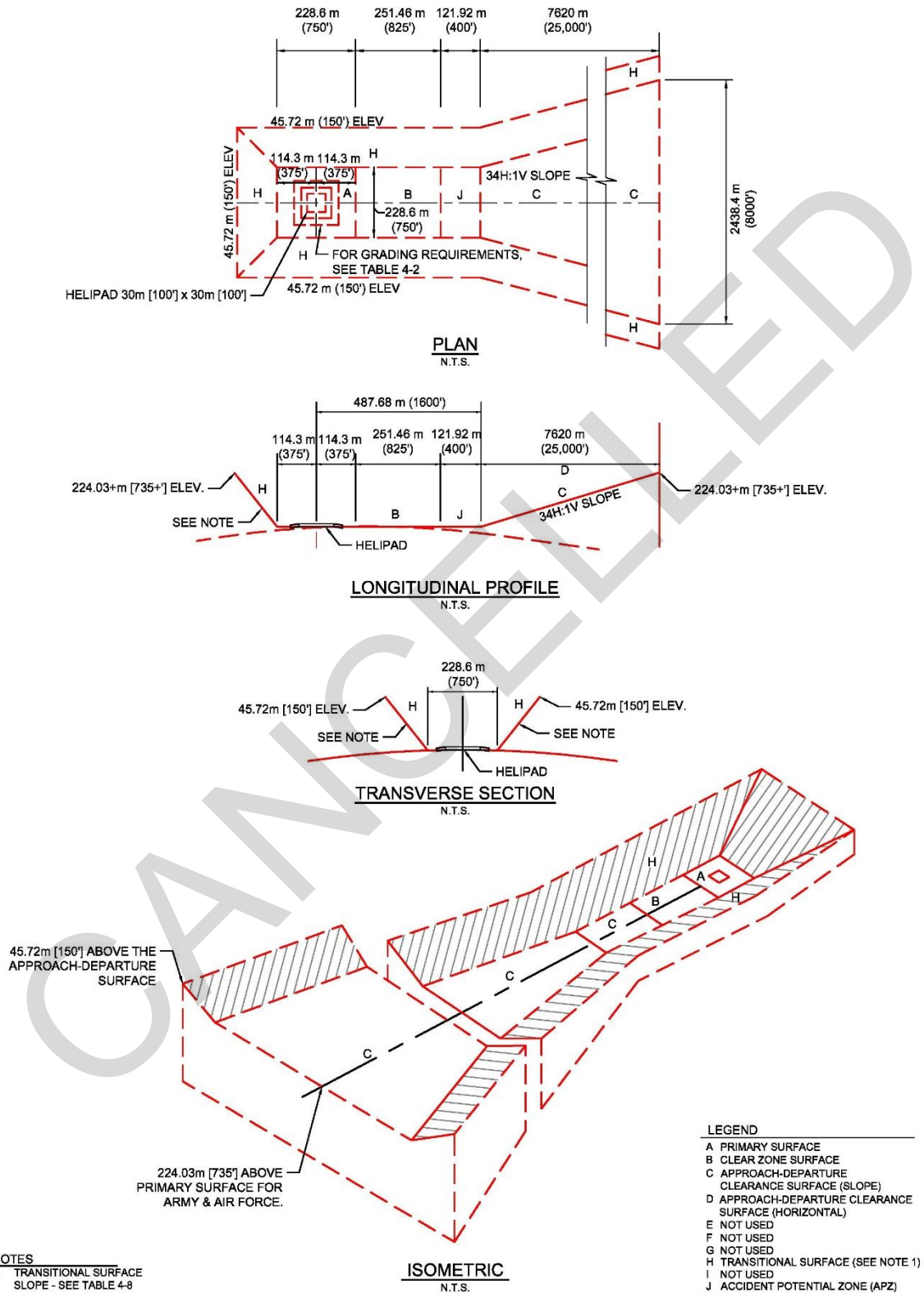
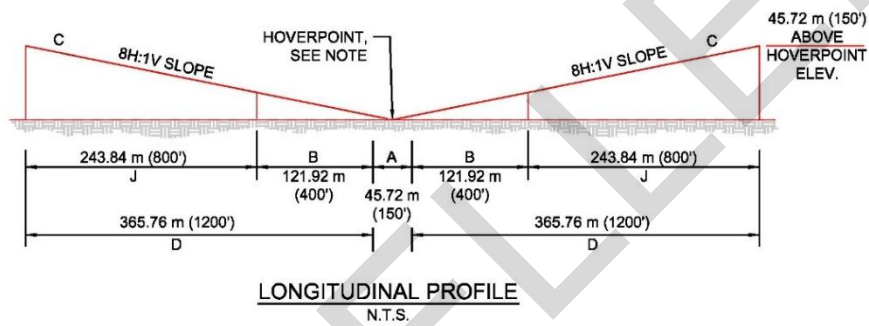
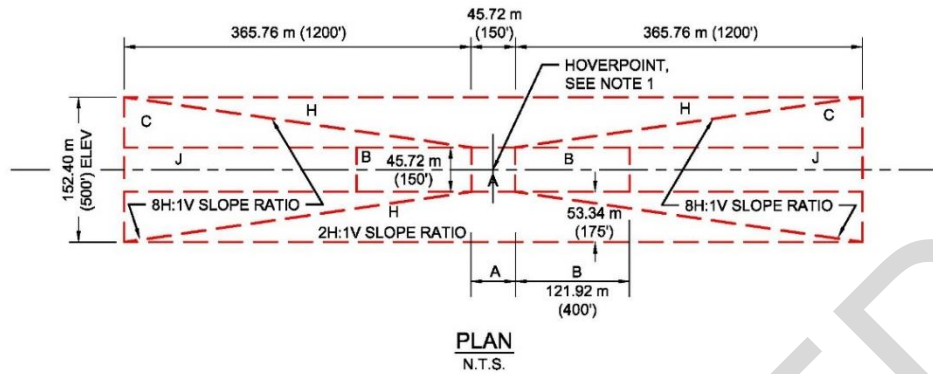
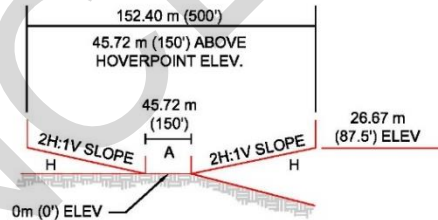

Figure 4-14. Helicopter Hoverpoint



**NOTES**

1. A HOVERPOINT CONSISTS OF A PAVED AREA 9m (30') IN DIAMETER, DOMED TO A 150mm (6") HEIGHT AT THE CENTER.
2. APPROACH-DEPARTURE CLEARANCE SURFACE (C), CLEAR ZONE (B), AND APZ (J) APPLICABLE TO BOTH ENDS OF HOVERPOINT.



**LEGEND**

- A PRIMARY SURFACE
- B CLEAR ZONE SURFACE
- C APPROACH-DEPARTURE CLEARANCE SURFACE (SLOPE)
- D APPROACH-DEPARTURE CLEARANCE SURFACE (HORIZONTAL)
- E NOT USED
- F NOT USED
- G NOT USED
- H TRANSITIONAL SURFACE
- J NOT USED
- ACCIDENT POTENTIAL ZONE (APZ)

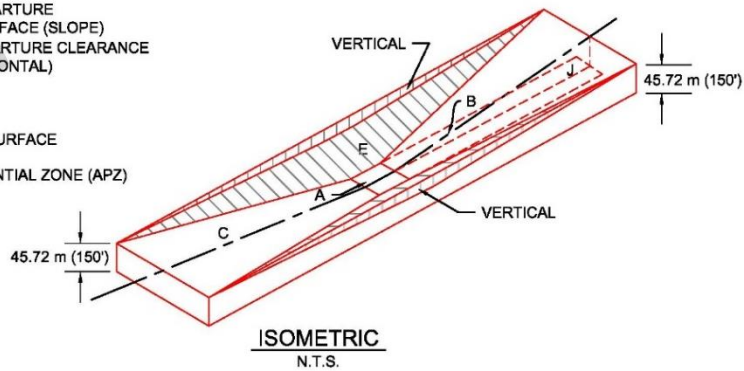

Table 4-3. Rotary-Wing Landing Lanes

Table 4-3. Rotary-Wing Landing Lanes			
Item		Requirement	Remarks
No.	Description		
1	Length	480 m (1,600 ft) to 600 m (2,000 ft)	Landing lane length based on the number of touchdown points. Evenly space touchdown points along the landing lane. Minimum length is for four touchdown points spaced 120 m (400 ft) apart. The first and last pad centers are 60.96 m (200 feet) inward from the ends of the landing lanes.
2	Width	23 m (75 ft)	For Navy and Marine Corps facilities, increase width to 30 m (100 ft) on landing lanes that will regularly accommodate H-53 and V-22 aircraft
3	Distance between touchdown points on landing lane, center to center	120 m, min (400 ft, min)	Provide a number of equally spaced "touchdown" or holding points with adequate separation.
4	Longitudinal grade	Max. 1.0%	Maximum longitudinal grade change is 0.167% per 30 linear meters (100 linear feet). Exceptions: 0.4% per 30 linear meters (100 linear feet) is allowable for edge of landing lanes at intersections
5	Transverse grade	Min. 1.0% Max. 1.5%	From centerline of landing lane. Landing lanes may be crowned or uncrowned
6	Paved shoulders		See Table 4-4.
7	Distance between centerlines of rotary-wing landing lanes	60.96 m (200 ft)  91.44 m (300 ft)	For operations with an active operational air traffic control tower.  For operations without an active operational air traffic control tower.
8	Landing lane lateral clearance zone (corresponds to half the width of primary surface area)	45.72 m (150 ft)  114.3 m (375 ft)	VFR facilities. Measured perpendicularly from centerline of runway to fixed or mobile obstacles. See Table 4-1, item 6, for obstacles definition.  IFR facilities. Measured perpendicularly from centerline of runway to fixed or mobile obstacles. See Table 4-1, item 6, for obstacles definition.
9	Grades within the primary surface area in any direction	Min 2.0% Max 5.0%	Exclusive of pavement and shoulders.
10	Overrun	See Remarks	See Table 4-5
11	Clear zone*	See Remarks	See Table 4-6.
12	APZ I*	See Remarks	See Table 4-6.
13	Distance between centerlines of a fixed-wing runway and landing lane	See Table 4-1, item 9  213.36 m min (700 ft min)	

\* The clear zone area for landing lanes corresponds to the clear zone land use criteria for fixed-wing airfields as defined in DoD AICUZ standards. The remainder of the approach-departure zone corresponds to APZ I land use criteria similarly defined. APZ II criteria are not applicable for rotary-wing aircraft.

**NOTES:**

1. Metric units apply to new airfield construction and, where practical, modification to existing airfields and heliports, as discussed in paragraph 1-3.4.
2. The criteria in this manual are based on aircraft specific requirements and are not direct conversions from inch-pound (English) dimensions. Inch-pound units are included only as a reference to the previous standard.
3. Airfield and heliport imaginary surfaces and safe wingtip clearance dimensions are shown as a direct conversion from inch-pound to SI units.

**Figure 4-15. Rotary-Wing Landing Lane**

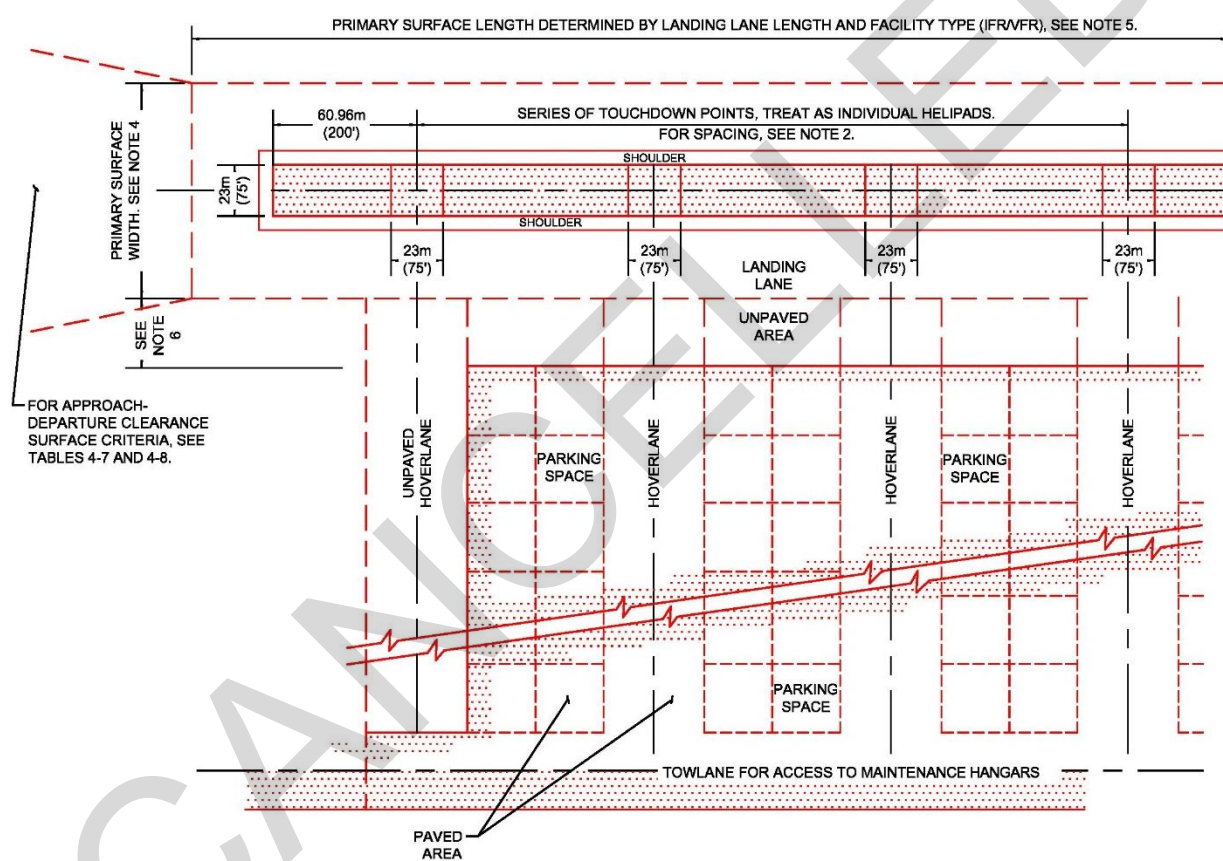

**NOTES**

1. WIDTH OF HOVER LANES AND PARKING SPACES ARE DETERMINED BY THE TYPE OF HELICOPTER USED AND THE CLEARANCES REQUIRED.
2. THE DISTANCE BETWEEN THE TOUCHDOWN POINTS IS DETERMINED BY THE DISTANCE BETWEEN HOVERLANE CENTERLINES AND IS USUALLY NOT LESS THAN 120m (400') CENTER-TO-CENTER.
3. SIZE AND LAYOUT OF THE PARKING APRON VARIES WITH THE TYPE OF HELICOPTER USED AND THE MISSION REQUIREMENTS.
4. PRIMARY SURFACE WIDTH IS 91.44m (300') FOR VFR FACILITIES AND 228.60m (750') FOR IFR FACILITIES.
5. PRIMARY SURFACE LENGTH IS THE LANDING LANE LENGTH PLUS 45.72m (150') FOR ARMY AND AIR FORCE VFR LANDING LANES AND 60.96m (200') FOR NAVY AND MARINE CORPS VFR LANDING LANES. FOR ARMY, AIR FORCE, NAVY AND MARINE CORPS IFR LANDING LANES, THE PRIMARY SURFACE LENGTH IS THE LANDING LANE LENGTH PLUS 121.92m (400').
6. MINIMUM DISTANCE BETWEEN THE PRIMARY SURFACE AND THE APRON IS DETERMINED BY THE TRANSITIONAL SURFACE CLEARANCE TO PARKED AIRCRAFT. TRANSITIONAL SURFACE SLOPES ARE SHOWN IN TABLES 4-7 AND 4-8.

**LEGEND**

 PAVEMENT

**4-9 AIR FORCE HELICOPTER SLIDE AREAS (OR “SKID PADS”).**

VFR helicopter runway criteria described in Table 4-1 and shown in Figures 4-1 and 4-8 (in terms of length, width, grade, and imaginary surfaces) are suitable for slide areas. The forces associated with helicopters landing at a small (but significant) rate of descent, and between 10 and 30 knots of forward velocity, require that slide area surfaces have both good drainage and some resistance to rutting; however, these landing surfaces need not be paved. Refer to UFC 3-260-02 for helicopter slide area structural criteria.

**4-10 SHOULDERS FOR ROTARY-WING FACILITIES.**

Unprotected areas adjacent to runways and overruns are susceptible to erosion caused by rotor wash. The shoulder width for rotary-wing runways, helipads, and landing lanes, shown in Table 4-4, includes both paved and unpaved shoulders. Paved shoulders are required adjacent to all helicopter operational surfaces, including runways, helipads, landing lanes, and hoverpoints. The unpaved shoulder must be graded to prevent water from ponding on the adjacent paved area. The drop-off next to the paved area prevents turf, which may build up over the years, from ponding water. Rotary-wing facility shoulders are illustrated in Figures 4-1 through 4-11. See paragraph 2-12 for requirements for designing buried utility structures in shoulders.

**Table 4-4. Shoulders for Rotary-Wing Facilities**

Table 4-4. Shoulders for Rotary-Wing Facilities			
Item		Requirement	Remarks
No.	Description		
1	Total width of shoulders (paved and unpaved) adjacent to all operational pavements	7.5 m (25 ft)	May be increased when necessary to accommodate dual operations with fixed-wing aircraft
2	Paved shoulder width	7.5 m (25 ft)	Air Force, Army, Navy and Marine Corps  Exception: For Navy and Marine Corps helipads, use 3.75 m (12.5 ft) paved shoulders.  Note: For V-22 and CH-53 taxiways, increase paved shoulder width to ensure 30 m (100 ft) total width (taxiway and shoulder) of paved surface.
3	Longitudinal grade	Variable	Conform to the longitudinal grade of the abutting primary pavement
4	Transverse grade	2.0% min 4.0% max	Slope downward from edge of pavement
5	Grade (adjacent to paved shoulder)	(a) 40-mm (1.5-in) drop-off at edge of paved shoulder +/- 13 mm (0.5 in)	Primary surface and clear zone criteria apply beyond this point.

Table 4-4. Shoulders for Rotary-Wing Facilities			
Item		Requirement	Remarks
No.	Description		
		(b) minimum 2%, maximum 5% within the primary surface	

**NOTES:**

1. Metric units apply to new airfield construction and, where practical, modification to existing airfields and heliports, as discussed in paragraph 1-3.4.
2. The criteria in this manual are based on aircraft specific requirements and are not direct conversions from inch-pound (English) dimensions. Inch-pound units are included only as a reference to the previous standard.
3. Airfield and heliport imaginary surfaces and safe wingtip clearance dimensions are shown as a direct conversion from inch-pound to SI units.

**4-11 OVERRUNS FOR ROTARY-WING RUNWAYS AND LANDING LANES.**

OVERRUNS are required at the end of all rotary-wing runways and landing lanes. Table 4-5 shows the dimensional requirements for overruns for rotary-wing runways and landing lanes. The pavement in the overrun is considered a paved shoulder. Rotary-wing overruns for runways and landing lanes are illustrated in Figures 4-1, 4-2, and 4-15. See paragraph 2-12 for requirements for designing buried utility structures in overruns.

**Table 4-5. Overruns for Rotary-Wing Runways and Landing Lanes**

Table 4-5. Overruns for Rotary-Wing Runways and Landing Lanes			
Item		Requirement	Remarks
No.	Description		
1	Total length (paved and unpaved)	23 m (75 ft)	
2	Paved length of overrun	7.5 m (25 ft) 0 m (0 ft)	Air Force and Army only Navy
3	Width	38 m (125 ft)	Width of runway plus shoulders  A minimum width of 45 m (150 ft) for airfields that regularly accommodate H-53 and V-22 aircraft (30-m (100-ft) runway and 7.5-m (25-ft) shoulders)
4	Longitudinal centerline grade	Same as last 150 m (500 ft) of runway. Remainder Max. 1.0%	To avoid abrupt changes in longitudinal grade between the runway and overrun, the maximum change of grade is 2.0% per 30 linear m (100 linear ft)
5	Transverse grade (paved and unpaved)	Min. 2.0% Max. 3.0%	Warp to meet runway and shoulder grades.

**NOTES:**

1. Metric units apply to new airfield construction and, where practical, modification to existing airfields and heliports, as discussed in paragraph 1-3.4.

2. The criteria in this manual are based on aircraft specific requirements and are not direct conversions from inch-pound (English) dimensions. Inch-pound units are included only as a reference to the previous standard.
3. Airfield and heliport imaginary surfaces and safe wingtip clearance dimensions are shown as a direct conversion from inch-pound to SI units.

#### **4-12 CLEAR ZONE AND ACCIDENT POTENTIAL ZONE (APZ).**

The clear zone and APZ are areas on the ground, located under the rotary-wing approach-departure surface. The clear zone and APZ are required for rotary-wing runways, helipads, landing lanes, and hoverpoints.

##### **4-12.1 Clear Zone Land Use.**

The clear zone for rotary-wing facilities must be free of obstructions, both natural and man-made, and rough-graded to minimize damage to an aircraft that runs off or lands short of the end of the landing surface. In addition, the clear zone permits recovery of aircraft that are aborted during takeoff. The clear zone should be either owned or protected under a long-term lease. Land use for the clear zone area for rotary-wing facilities corresponds to the clear zone land use criteria for fixed-wing airfields as defined for DoD AICUZ and Service-specific standards and as discussed in Chapter 3.

##### **4-12.2 Accident Potential Zone (APZ).**

Land use for the APZ area at rotary-wing facilities corresponds to the APZ land use criteria for fixed-wing airfields as defined in DoD AICUZ and Service-specific standards and as discussed in Chapter 3. Ownership of the APZ is desirable but not required. If ownership is not possible, land use should be controlled through long-term lease agreements or local zoning ordinances.

##### **4-12.3 Dimensions.**

Table 4-6 shows the dimensional requirements for the clear zone and APZ. These dimensions apply to rotary-wing runways, helipads, landing lanes, and hoverpoints, depending on whether they support VFR or IFR operations. Layout of the clear zone and APZ are shown in Figures 4-1, 4-2, and 4-8 through 4-15.

#### **4-13 IMAGINARY SURFACES FOR ROTARY-WING RUNWAYS, HELIPADS, LANDING LANES, AND HOVERPOINTS.**

Rotary-wing runways, helipads, landing lanes, and hoverpoints have imaginary surfaces similar to the imaginary surfaces for fixed-wing facilities. The imaginary surfaces are defined planes in space that establish clearance requirements for helicopter operations. An object, either man-made or natural, that projects through an imaginary surface plane is an obstruction to air navigation. Layout of the rotary-wing airspace imaginary surfaces is provided in Tables 4-7 and 4-8 and Figures 4-1 through 4-15. Rotary-wing airspace imaginary surfaces are defined in the glossary and listed here:

Primary surface



- Approach-departure clearance surface (VFR)
- Approach-departure clearance surface (VFR limited use helipads)
- Approach-departure clearance surface (IFR)
- Horizontal surface (IFR)
- Transitional surfaces

**Table 4-6. Rotary-Wing Runway and Landing Lane Clear Zone and APZ**

Table 4-6. Rotary-Wing Runway and Landing Lane Clear Zone and APZ <sup>1,2</sup>			
Item		Requirement	Remarks
No.	Description		
1	Clear zone length	121.92 m (400 ft)	Clear zone begins at the end of the primary surface.
2	Clear zone width (center width on extended runway/landing lane centerline) (corresponds to the width of the primary surface)	91.44 m (300 ft)	VFR rotary-wing runways and landing lanes See note 2.
		228.60 m (750 ft)	IFR rotary-wing runways and landing lanes See note 2.
3	Grades in clear zone in any direction	2.0% Min. 5.0% Max.	Clear zone only Area to be free of obstructions. Rough-grade and turf when required.
4	APZ I length	243.84 m (800 ft)	See notes 2 and 3.
5	APZ I width	91.44 m (300 ft)	VFR rotary-wing runways and landing lanes See notes 2 and 3.
		228.60 m (750 ft)	IFR rotary-wing runways and landing lanes See notes 2 and 3.

**NOTES:**

1. The clear zone area for rotary-wing runways and landing lanes corresponds to the clear zone land use criteria for fixed-wing airfields as defined in DoD and Service-specific AICUZ standards and as discussed in Chapter 3 . The remainder of the approach-departure zone corresponds to APZ I land use criteria similarly defined. APZ II criteria is not applicable for rotary-wing aircraft.
2. No grading requirements for APZ I.
3. Metric units apply to new airfield construction and, where practical, modification to existing airfields and heliports, as discussed in paragraph 1-3.4.
4. The criteria in this manual are based on aircraft specific requirements and are not direct conversions from inch-pound (English) dimensions. Inch-pound units are included only as a reference to the previous standard.
5. Airfield and heliport imaginary surfaces and safe wingtip clearance dimensions are shown as a direct conversion from inch-pound to SI units.

Table 4-7. Rotary-Wing Imaginary Surface for VFR Approaches

Table 4-7. Rotary-Wing Imaginary Surface for VFR Approaches							
Item		Legend in Figures	Helicopter Runway and Landing Lane	Helipad		Elevated Helipad	Remarks
No.	Description			Air Force and Army VFR Standard	Air Force and Army VFR Standard Helipad and Hoverpoints <sup>1,2</sup>	Air Force and Army	
1	Primary surface width	A	91.44 m (300 ft)	91.44 m (300 ft)	45.72 m (150 ft)	59.4 m (195ft) for UH60 and smaller helicopters  91.44 m (300 ft) for CH47 and larger helicopters	Centered on the ground point of intercept (GPI).
2	Primary surface length	A	Runway or landing lane length plus 22.86 m (75 ft) at each end	91.44 m (300 ft) centered on facility	45.72 m (150 ft) centered on facility	59.4 m (195 ft) for UH60 and smaller helicopters  91.44 m (300 ft) for CH47 and larger helicopters	Runway or landing lane length plus 30.48 m (100 ft) at each end for Navy and Marine Corps facilities.
3	Primary surface elevation	A	The elevation of any point on the primary surface is the same as the elevation of the nearest point on the runway centerline or at the established elevation of the landing surface.			The elevation of any point on the primary surface is the same as the established elevation of the landing surface	
4	Clear zone surface	B	See Table 4-6	See Table 4-2	See Table 4-2	See Table 4-2	
5	Start of approach-departure surface	C	22.86 m (75 ft) from end of runway or landing lane	45.72 m (150 ft) from GPI	22.86 m (75 ft) from GPI	29.7 m (97.5 ft) from GPI for UH60 and smaller helicopters	

						45.72 m (150 ft) from GPI for CH47 and larger helicopters	
6	Length of sloped portion of approach- departure surface	C	365.76 m (1,200 ft)	365.76 m (1,200 ft)*	365.76 m (1,200 ft)*	365.76 m (1,200 ft)*	Measured horizontally. *(For Army Hospital Helipads – The length shall be 749.82m (2460') when a CHAPI is used).
7	Slope of approach- departure surface	C	8:1	8:1**	8:1**	8:1**	See remarks below.
			Slope ratio is horizontal to vertical. 8:1 is 8 m (ft) horizontal to 1 m (ft) vertical. **(For Army Hospital Helipads – The slope shall be 16.4:1 when a Chase Helicopter Approach Path Indicator (CHAPI) is used).				
8	Width of sloped portion of approach- departure surface at start of sloped portion	C	91.44 m (300 ft)	91.44 m (300 ft)	45.72 m (150 ft)	59.4 m (195 ft) for UH60 and smaller helicopters  83.3 m (275 ft) for CH47 and larger helicopters	Centered on the extended center- line, and is the same width as the primary surface.
9	Width of sloped portion of approach- departure surface at end of sloped portion	C	182.88 m (600 ft)	182.88 m (600 ft)	152.4 m (500 ft)	Small 150.88 m (495 ft)  Large 182.88 m (600 ft)  *** Small – 246.89 m (810 ft) *** Large – 278.90 m (915 ft)	Centered on the extended center- line.      *** (For Army Hospital Helipads when a CHAPI is used).
10	Elevation of approach- departure surface at start of sloped portion	C	0 m (0 ft)	0 m (0 ft)	0 m (0 ft)	0 m (0 ft)	Above the established elevation of the landing surface.
11	Elevation of approach- departure surface at end	C	45.72 m (150 ft)	45.72 m (150 ft)	45.72 m (150 ft)	45.7 m (150 ft)	Above the established elevation of the landing surface.

	of sloped portion						
12	Length of approach-departure zone	D	365.76 m (1,200 ft)	365.76 m (1,200 ft)*	365.76 m (1,200 ft)*	365.76 m (1,200 ft)*	See remarks below.
			Measured horizontally from the end of the primary surface and is the same length as the approach-departure clearance surface length *(For Army Hospital Helipads – The length shall be 749.82m (2460') when a CHAPI is used).				
13	Start of approach-departure zone	D	22.86 m (75 ft) from end of runway	45.72 m (150 ft) from center of helipad	22.86 m (75 ft) from center of helipad	29.7 m (97.5 ft) from center of helipad for UH60 and smaller helicopters  45.72 m (150 ft) from center of helipad for CH47 and larger helicopters	Starts at the end of the primary surface.
14	Transitional surface slope	H	2H:1V See remark 1	2H:1V See remark 1	2H:1V See remark 2	2H:1V See remark 2	See remarks below.
			(1) The transitional surface starts at the lateral edges of the primary surface and the approach-departure clearance surface. It continues outward and upward at the prescribed slope to an elevation of 45.72 m (150 ft) above the established airfield elevation. (2) The transitional surface starts at the lateral edges of the primary surface and the approach-departure clearance surface. It continues outward and upward at the prescribed slope to a point 250 ft from extended helipad/hoverpoint centerline. It then rises vertically to an elevation of 45.7 m (150 ft) above the established airfield elevation. (3) See Figures 4-8 and 4-14 for the shape of transitional surfaces.				
15	Horizontal surface	G	Not required	Not required	Not required	Not required	

**NOTES:**

1. The Navy and Marine Corps do not have criteria for same direction ingress/egress.
2. Metric units apply to new airfield construction and, where practical, modification to existing airfields and heliports, as discussed in paragraph 1-3.4.
3. Elevated helipads apply only to Army.

Table 4-8. Rotary-Wing Imaginary Surfaces for IFR Approaches

Table 4-8. Rotary-Wing Imaginary Surfaces for IFR Approaches						
Item		Legend in Figures	Helicopter Runway and Landing Lanes	Helipad		Remarks
No.	Description			Standard	Same Direction Ingress/Egress	
1	Primary surface width	A	228.60 m (750 ft)	228.60 m (750 ft)	228.60 m (750 ft)	Centered on helipad
2	Primary surface length	A	The runway or landing lane length plus 60.96 m (200 ft) at each end.	472.44 m (1,550 ft) centered on GPI	228.6 m (750 ft) centered on GPI	
3	Primary surface elevation	A	The elevation of any point on the primary surface is the same as the elevation of the nearest point on the runway or landing lane centerline or established elevation of the helipad.			
4	Clear zone surface	B	See Table 4-6	See Table 4-2	See Table 4-2	
5	Start of approach-departure surface	C	Begins 60.96 m (200 ft) feet beyond the end of runway, coincident with end of primary surface	236.22 m (775 ft) from GPI	487.68 m (1,600 ft) from GPI	Army and Air Force facilities
			236.22 m (775 ft) from GPI.	236.22 m (775 ft) from GPI.	N/A	Navy and Marine Corps facilities
			See Remarks	See Remarks	See Remarks	Starts at the end of the primary surface
6	Length of sloped portion of approach-departure surface	D	7,620.00 m (25,000 ft)	7,620.00 m (25,000 ft)	7,620.00 m (25,000 ft)	Army and Air Force facilities
			7,383.78 m (24,225 ft)	7,383.78 m (24,225 ft)	N/A	Navy and Marine Corps facilities
			See Remarks	See Remarks	See Remarks	Measured horizontally
7	Slope of approach-departure surface	C	34:1	34:1	34:1	Army and Air Force Facilities
						Navy and Marine Corps do not have criteria for unidirectional ingress/egress.
			25:1	25:1	N/A	Navy and Marine Corps facilities
			See Remarks	See Remarks	See Remarks	Slope ratio is horizontal to vertical. 34:1 is 34 m (ft) horizontal to 1 m (ft) vertical.

**Table 4-8. Rotary-Wing Imaginary Surfaces for IFR Approaches**

Item		Legend in Figures	Helicopter Runway and Landing Lanes	Helipad		Remarks
No.	Description			Standard	Same Direction Ingress/Egress	
8	Width of approach-departure surface at start of sloped portion	C	228.60 m (750 ft)	228.60 m (750 ft)	228.60 m (750 ft)	Army and Air Force facilities
			228.60 m (750 ft)	228.60 m (750 ft)	N/A	Navy and Marine Corps facilities
			See Remarks	See Remarks	See Remarks	Centered on the extended centerline and is the same width as the primary surface
9	Width of approach-departure surface at end of sloped portion	C	2,438.60 m (8,000 ft)	2,438.60 m (8,000 ft)	2,438.60 m (8,000 ft)	Army and Air Force facilities
			2,438.60 m (8,000 ft)	2,438.60 m (8,000 ft)	N/A	Navy and Marine Corps facilities
			See Remarks	See Remarks	See Remarks	Centered on the extended centerline
10	Elevation of approach-departure surface at start of sloped portion	C	0 m (0 ft)	0 m (0 ft)	0 m (0 ft)	Army and Air Force facilities
			0 m (0 ft)	0 m (0 ft)	N/A	Navy and Marine Corps facilities
			See Remarks	See Remarks	See Remarks	Above the established elevations of the landing surface
						Navy and Marine Corps do not have criteria for unidirectional ingress/egress.
11	Elevation of approach-departure clearance surface at end of sloped portion	C	224.03 m (735 ft)			Air Force and Army
			295.35 m (969 ft)		N/A	Navy and Marine Corps
			See Remarks			Above the established elevation of the landing surface
12	Transitional surface slope	H	4:1	4:1	4:1	Army
			4:1	4:1	4:1	Air Force
			4:1	4:1	N/A	Navy and Marine Corps
			The transitional surface starts at the lateral edges of the primary surface and the approach-departure clearance surface. It continues outward and upward at the prescribed slope to 45.72 m (150 ft) above the established airfield elevation.			
13	Horizontal surface radius	E	1,143 m (3,750 ft) for 25:1 approach-departure surfaces	N/A	N/A	Navy and Marine Corps airfields only. An imaginary surface located 45.72 m (150 ft) above the established heliport elevation, formed by

Table 4-8. Rotary-Wing Imaginary Surfaces for IFR Approaches

Item		Legend in Figures	Helicopter Runway and Landing Lanes	Helipad		Remarks
No.	Description			Standard	Same Direction Ingress/Egress	
						scribing an arc about the end of each runway or landing lane, and interconnecting these arcs with tangents
			1,554.48 m (5,100 ft) for 34:1 approach-departure surfaces	N/A	N/A	Navy and Marine Corps airfields only
			N/A	1,402.08 m (4,600 ft)	1,402.08 m (4,600 ft)	Navy and Marine Corps airfields only. Circular in shape, located 45.72 m (150 ft) above the established heliport or helipad elevation, defined by scribing an arc with a 1,402.08 m (4,600 ft) radius about the center point of the helipad
14	Elevation of horizontal surface	H	45.72 m (150 ft)	45.72 m (150 ft)	45.72 m (150 ft)	Navy and Marine Corps airfields only

**NOTES:**

1. Metric units apply to new airfield construction and, where practical, modification to existing airfields and heliports, as discussed in paragraph 1-3.4.
2. The criteria in this manual are based on aircraft specific requirements and are not direct conversions from inch-pound (English) dimensions. Inch-pound units are included only as a reference to the previous standard.
3. Airfield and heliport imaginary surfaces and safe wingtip clearance dimensions are shown as a direct conversion from inch-pound to SI units.
4. N/A = not applicable

**4-14 OBSTRUCTIONS AND AIRFIELD AIRSPACE CRITERIA.**

If the imaginary surface around a rotary-wing runway, helipad, elevated helipad, landing lane, or hoverpoint is penetrated by man-made or natural objects as defined in 14 CFR Part 77, Paragraph 77.23 "Standards for Determining Obstruction", the penetrating object is an obstruction.

THIS PAGE INTENTIONALLY BLANK

CANCELLED



## CHAPTER 5 TAXIWAYS

### 5-1 CONTENTS.

This chapter presents design standards and considerations for fixed- and rotary-wing taxiways.

### 5-2 TAXIWAY REQUIREMENTS.

Taxiways provide for ground movement of fixed- and rotary-wing aircraft. Taxiways connect the runways, helipads and other landing/takeoff surfaces of the airfield with the parking and maintenance areas and provide access to hangars, docks, and various parking aprons and pads.

### 5-3 TAXIWAY SYSTEMS.

#### 5-3.1 Basic.

The basic airfield layout consists of a taxiway connecting the center of the runway, helipads and other landing/takeoff surfaces with the parking apron. This system limits the number of aircraft operations at an airfield. Departing aircraft must taxi on the runway to reach the runway threshold. When aircraft are taxiing on the runway, no other aircraft is allowed to use the runway. If runway operations are minimal or capacity is low, the basic airfield layout with one taxiway may be an acceptable layout.

#### 5-3.2 Parallel Taxiway.

A taxiway parallel for the length of the runway, with connectors to the end of the runway and parking apron, is the most efficient taxiway system. Aircraft movement is not hindered by taxiing operations on the runway, and the connectors permit rapid entrance and exit of traffic.

#### 5-3.3 High-Speed Taxiway Turnoff.

High-speed taxiway turnoffs are located intermediate of the ends of the runway to increase the capacity of the runway. The high-speed taxiway turnoff enhances airport capacity by allowing aircraft to exit the runways at a faster speed than turnoff taxiways allow.

#### 5-3.4 Additional Types of Taxiways.

Besides the types of taxiways already discussed in this section, there are other taxiways at an airfield. Taxiways are often referred to based on their function. Common airfield taxiways and their designations are shown in Figure 5-1.

#### 5-3.5 Taxilanes.

A taxi route through an apron is referred to as a “taxilane.” Taxilanes are discussed further in Chapter 6 for the Army and Air Force and UFC 2-000-05N for the Navy and Marine Corps.

**5-3.6 USAF Taxitraks.**

A taxi route connecting a dispersed parking platform (e.g., a fighter loop) to a taxiway or runway is referred to as a “taxitrak.” Dispersed parking platform and taxitrak use are limited to fighter aircraft only. Use of taxitraks by tactical transport aircraft is permitted provided minimum clearances as set by MAJCOM guidance are met. Table 5-7 presents the criteria for taxitraks.

CANCELLED

Figure 5-1. Common Taxiway Designations

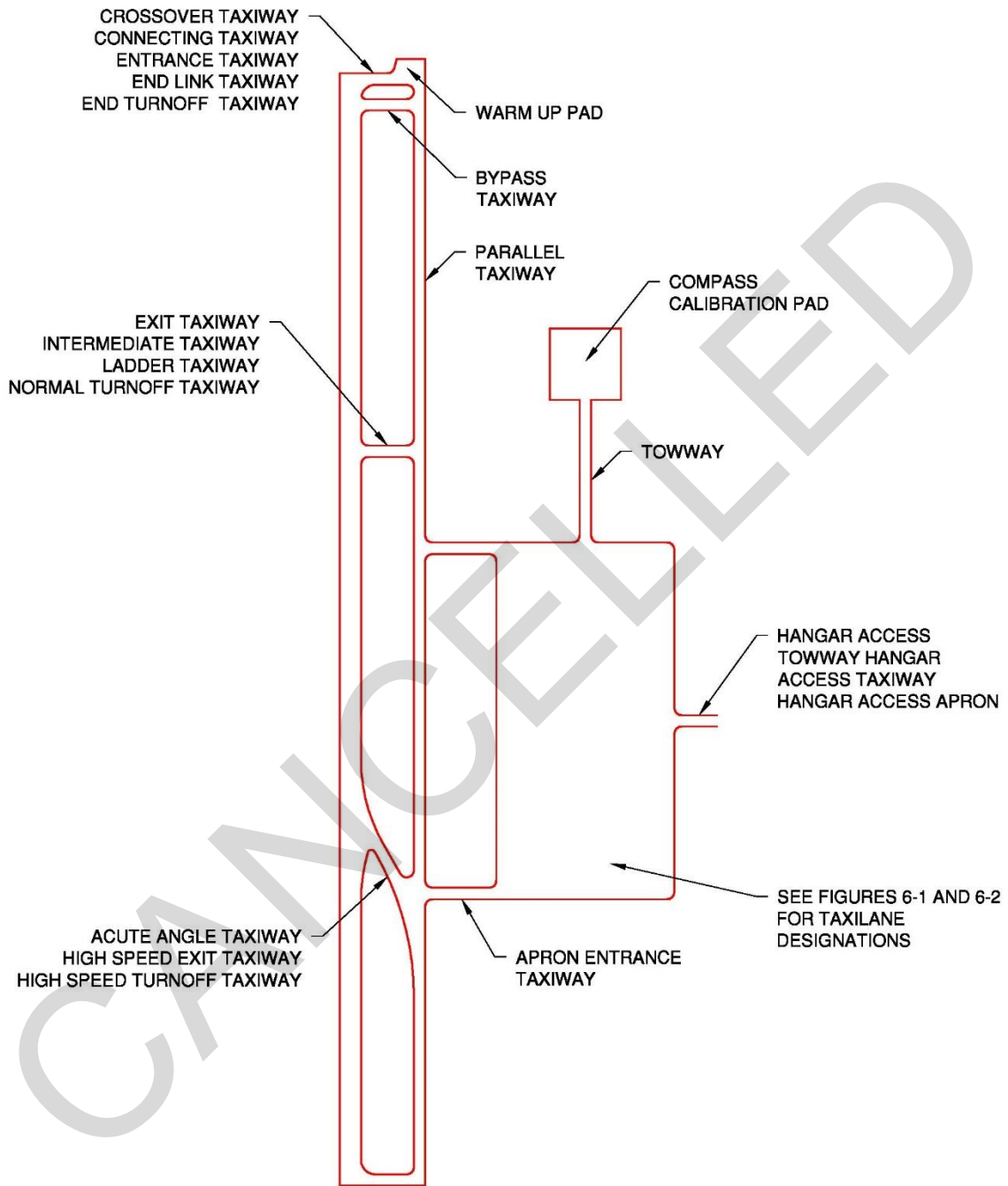

PLAN  
N.T.S.

**NOTES**

1. TAXIWAY LAYOUT IS FOR GUIDANCE ONLY.

## **5-4 TAXIWAY LAYOUT.**

These considerations should be addressed when planning and locating taxiways at an airfield:

### **5-4.1 Efficiency.**

Runway efficiency is enhanced by planning for a parallel taxiway.

### **5-4.2 Direct Access.**

Taxiways should provide as direct an access as possible from the runway, helipads and other landing/takeoff surfaces to the apron. Connecting taxiways should be provided to join the runway, helipads and other landing/takeoff surfaces exit points to the apron.

### **5-4.3 Simple Taxiing Routes.**

A sufficient number of taxiways should be provided to prevent complicated taxiing routes. Turning from one taxiway onto another often creates confusion and may require additional airfield signs and communication with the air traffic control tower.

### **5-4.4 Delay Prevention.**

A sufficient number of taxiways should be provided to prevent capacity delays that may result when one taxiway must service more than one runway.

### **5-4.5 Runway Exit Criteria.**

The number, type, and location of exits is a function of runway length, as shown in Figure 5-2 and as discussed in Chapter 2.

### **5-4.6 Taxiway Designation.**

Use letters of the alphabet for designating taxiways. Optimally, designation of the taxiways should start at one end of the airport and continue to the opposite end, e.g., east to west or north to south (see UFC 3-535-01). Designate all separate, distinct taxiway segments. Do not use the letters I, O, or X for taxiway designations.

Figure 5-2. Spacing Requirements: Normal Taxiway Exits

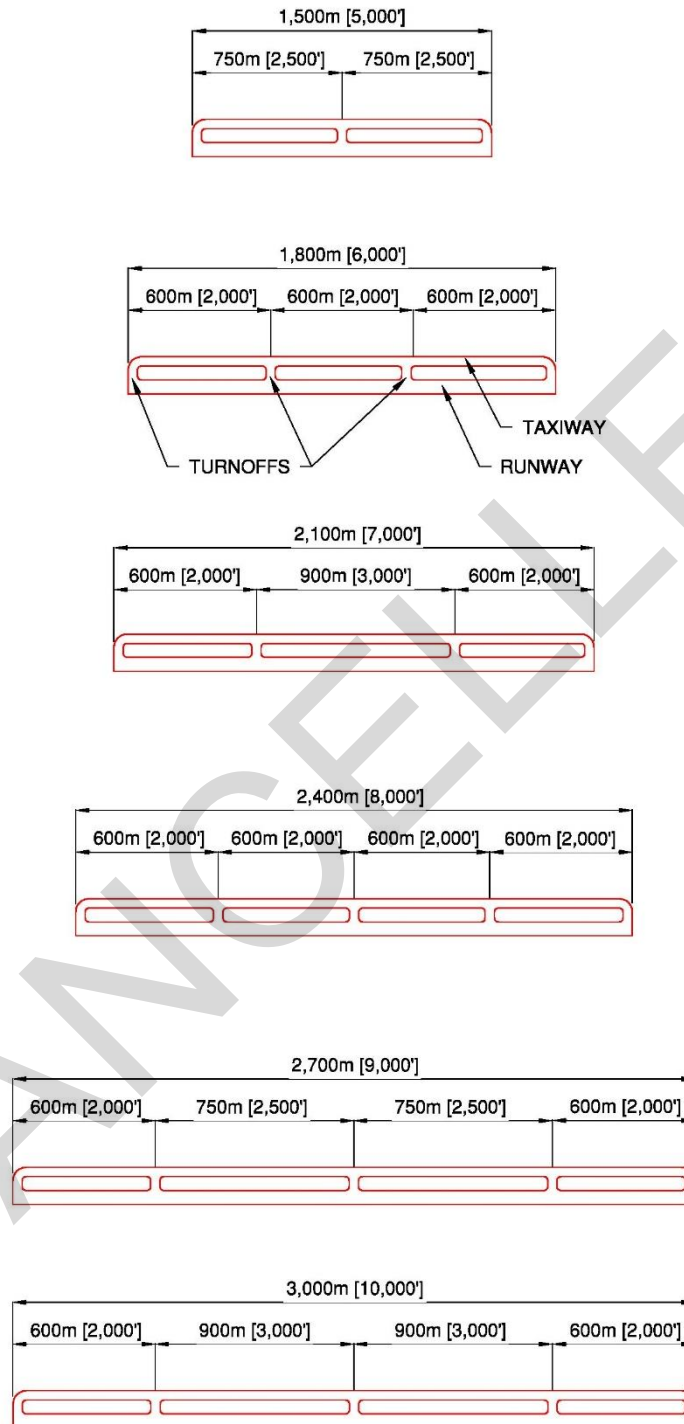

NORMAL TAXIWAY EXITS  
N.T.S.

**5-5 FIXED-WING TAXIWAY DIMENSIONS.**

The dimensions of a taxiway are based on the class of runway that the taxiway serves.

**5-5.1 Criteria.**

Table 5-1 presents the criteria for fixed-wing taxiway design, including clearances, slopes, and grading dimensions.

**5-5.2 Transverse Cross-Section.**

A typical transverse cross-section of a taxiway is shown in Figure 5-3.

**Table 5-1. Fixed-Wing Taxiways**

Table 5-1. Fixed-Wing Taxiways				
Item		Class A Runway	Class B Runway	Remarks
No.	Description	Requirement		
1	Width	15 m (50 ft)	23 m (75 ft)	Army and Air Force airfields
		12 m (40 ft)	23 m (75 ft)	Navy and Marine Corps airfields
		See Remarks		May be modified for particular mission requirements (special taxiways such as high-speed and end turn-off)
2	Total width of shoulders (paved and unpaved)	7.5 m (25 ft)	15 m (50 ft)	
3	Paved shoulder width	7.5 m (25 ft)	7.5 m (25 ft)	Army and Air Force airfields except as noted below
		N/A	3 m (10 ft)	Air Force taxiways devoted exclusively for fighter and trainer aircraft A paved shoulder up to 7.5 m (25 ft) is allowed on the outside of taxiway turns of 90 degrees or more.
		N/A	15 m (50 ft)	Airfields for B-52 aircraft. Also see note 3.
		As Required	As Required	Navy and Marine Corps airfields – where V-22 operations occur, provide total paved width (taxiway and shoulder) of 30 m (100 ft). Where rotary operations occur on fixed wing taxiways, follow paragraph 5-7.2. Air Force airfields devoted exclusively to trainer aircraft operations. Local Commanders must complete a risk

Table 5-1. Fixed-Wing Taxiways				
Item		Class A Runway	Class B Runway	Remarks
No.	Description	Requirement		
				assessment if not opting to install shoulders.
4	Longitudinal grade of taxiway and shoulders	Max 3.0%		Army, Navy, and Marine Corps airfields.  For Navy and Marine Corps airfields, a maximum of 2.0% is recommended when jet aircraft are required to accelerate from a standing position.
		Max 1.5%		Air Force airfields.  A gradient exception of 5.0% is permitted for a distance of not more than 120 m (400 ft) unless within 180 m (600 ft) of a runway entrance. There, a 3.0% maximum applies.
		See Remarks		Grades may be positive or negative but must not exceed the limits specified.
5	Rate of longitudinal taxiway grade change	Max 1.0% per 30 m (100 ft)		The minimum distance between two successive points of intersection (PI) is 150 m (500 ft). Changes are to be accomplished by means of vertical curves.  For the Air Force and Army, up to a 0.4% change in grade is allowed without a vertical curve. A vertical curve is not necessary where a taxiway crosses a runway or taxiway crown.
6	Longitudinal sight distance	Min 600 m (2,000 ft) between eye level at 2.14 m (7 ft) and an object 3.05 m (10 ft) above taxiway pavement		Army, Navy, and Marine Corps airfield taxiways
		Min 300 m (1,000 ft). Any two points 3 m (10 ft) above the pavement must be mutually visible for the distance indicated.		Air Force airfield taxiways
7	Transverse grade of taxiway	Min 1.0% Max 1.5%		New taxiway pavements will be centerline crowned.  Slope pavement downward from the centerline of the taxiway.  When existing taxiway pavements have insufficient transverse gradients for rapid drainage, provide for increased gradients when the pavements are overlaid or reconstructed.

Table 5-1. Fixed-Wing Taxiways				
Item		Class A Runway	Class B Runway	Remarks
No.	Description	Requirement		
				The transverse gradients requirements are not applicable at or adjacent to intersections where pavements must be warped to match abutting pavements.
8	Transverse grade of paved shoulders	Min 2.0% Max 4.0%		Army, Navy, Marine Corps, and Air Force airfields not otherwise specified
		N/A	Min 1.5% Max 2.0%	Air Force taxiways designed for B-52 aircraft
9	Transverse grade of unpaved shoulders	(a) 40 mm (1.5 in) drop-off at edge of pavement +/- 13 mm (0.5 in) (b) 2.0% min, 4.0% max		For additional information, see Figure 5-3. Unpaved shoulders shall be graded to provide positive surface drainage away from paved surfaces.
10	Clearance from taxiway centerline to fixed or mobile obstacles (taxiway clearance line)	Min 45.72 m (150 ft)		Army, Navy, and Marine Corps airfields
		Min 45.72 m (150 ft)	Min 60.96 m (200 ft)	Air Force airfields
		See Remarks		See Table 3-2, item 12, for obstacle definition.
11	Distance between taxiway centerline and parallel taxiway/taxilane centerline	53 m (175 ft)	57 m (187.5 ft) or wingspan + 15.3 m (wingspan + 50 ft), whichever is greater	Army airfields
		53 m (175 ft)	72.4 m (237.5 ft) or wingspan + 15.3 m (wingspan + 50 ft), whichever is greater	Air Force and Navy airfields
12	Grade of area between taxiway shoulder and taxiway clearance line	Min of 2.0% prior to channelization Max 10.0% <sup>2</sup>		<p>Army, Air Force, Navy, and Marine Corps airfields, except as noted below.</p> <p>For additional information, see Figure 5-3.</p> <p>Unpaved areas shall be graded to provide positive surface drainage away from paved surfaces.</p> <p>For cases where the entire shoulder is paved (Class A airfields and taxiways designed for B-52 aircraft), provide a 40 mm (1.5-in) drop-off at pavement edge, +/- 13 mm (0.5 in).</p>

NOTES:



1. N/A = not applicable
2. Bed of channel may be flat. When drainage channels are required, the channel bottom cross section may be flat but the channel must be sloped to drain.
3. A 15-m (50-ft) paved shoulder is allowed for C-5, E-4, and 747 aircraft where vegetation cannot be established. Transverse grade of paved shoulder is 2% minimum to 4% maximum.
4. Metric units apply to new airfield construction and, where practical, modification to existing airfields and heliports, as discussed in paragraph 1-3.4.
5. The criteria in this manual are based on aircraft specific requirements and are not direct conversions from inch-pound (English) dimensions. Inch-pound units are included only as a reference to the previous standard.
6. Airfield and heliport imaginary surfaces and safe wingtip clearance dimensions are shown as a direct conversion from inch-pound to SI units.

CANCELLED

Figure 5-3. Taxiway and Primary Surface Transverse Sections

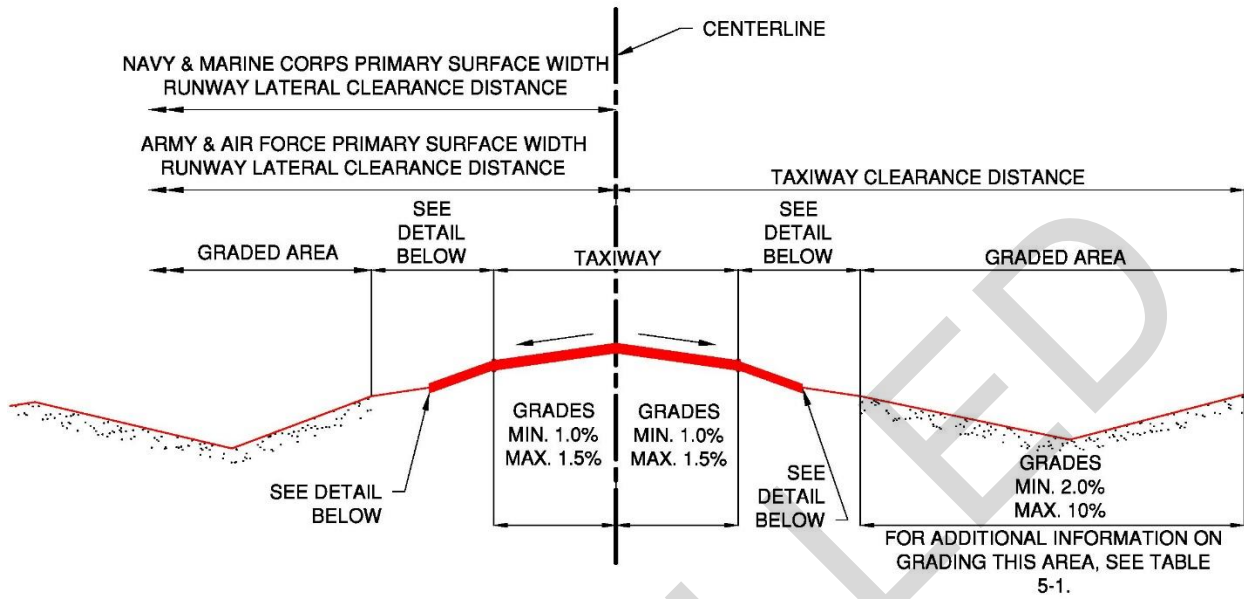

TAXIWAY TRANSVERSE SECTION  
N.T.S.

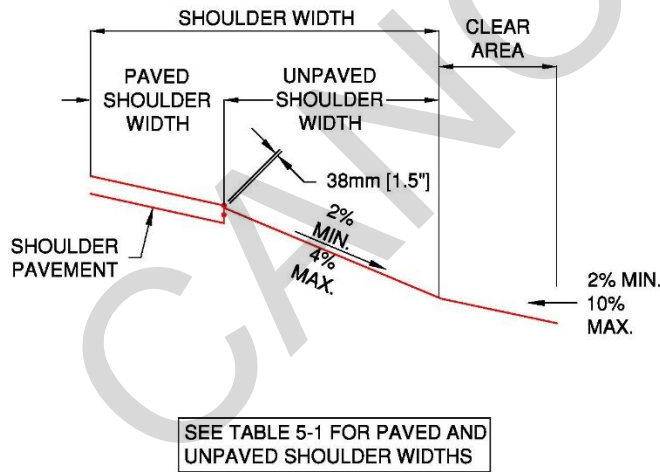

EDGE OF TAXIWAY FOR CLASS B RUNWAYS  
EXCEPT AS NOTED IN TABLE 5-1  
N.T.S.

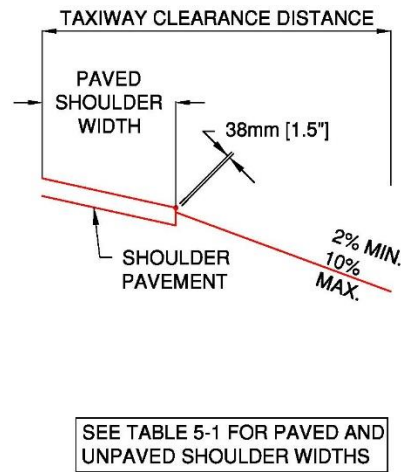

EDGE OF TAXIWAY FOR CLASS A RUNWAYS  
AND CLASS B RUNWAYS FOR B-52 AIRCRAFT  
N.T.S.

5-6 ROTARY-WING TAXIWAY DIMENSIONS.

Rotary-wing taxiways are either paved or unpaved. Wheel-gear configured rotary-wing aircraft require a paved surface on which to taxi. Skid-gear configured rotary-wing aircraft taxi by hovering along a paved or unpaved taxiway. Table 5-2 presents the criteria for rotary-wing taxiway design, including taxiway widths, clearances, slopes, and grading dimensions.

Table 5-2. Rotary-Wing Taxiways

Table 5-2. Rotary-Wing Taxiways			
Item		Requirement	Remarks
No.	Description		
1	Width	15 m (50 ft)	Army and Air Force facilities
		12 m (40 ft)	Navy and Marine Corps facilities
		See Remarks	Basic width applicable to taxiways that support helicopter operations only. When dual use taxiways support fixed-wing aircraft operations, use the appropriate fixed-wing criteria.
2	Longitudinal grade	Max 2.0%	
3	Rate of longitudinal grade change	Max 2.0% per 30 m (100 ft)	Longitudinal grade changes are to be accomplished using vertical curves. For the Air Force and Army, up to a 0.4% change in grade is allowed without a vertical curve. A vertical curve is not necessary where a taxiway crosses a runway or taxiway crown.
3	Transverse grade	Min 1.0% Max 1.5%	New taxiways are to be centerline crowned.
4	Paved shoulders		See Table 5-3.
5	Clearance from centerline to fixed and mobile obstacles (taxiway clearance line)	Min 30.48 m (100 ft)	Basic helicopters clearance. Increase as appropriate for dual use taxiways. See Table 3-2, item 12, for definitions of fixed and mobile obstacles.
6	Grades within the clear area	Max 5.0%	The clear area is the area between the taxiway shoulder and the taxiway clearance line.
7	Intersection fillet radius	See Table 5-4 and Table 5-5	Use the appropriate fillet depending on the width of the rotary-wing taxiway.

**NOTES:**

1. Metric units apply to new airfield construction and, where practical, modification to existing airfields and heliports, as discussed in paragraph 1-3.4.
2. The criteria in this manual are based on aircraft specific requirements and are not direct conversions from inch-pound (English) dimensions. Inch-pound units are included only as a reference to the previous standard.
3. Airfield and heliport imaginary surfaces and safe wingtip clearance dimensions are shown as a direct conversion from inch-pound to SI units.

**5-7 TAXIWAYS AT DUAL USE (FIXED- AND ROTARY-WING) AIRFIELDS.**

**5-7.1 Criteria.**

For taxiways at airfields supporting both fixed- and rotary-wing aircraft operations, the appropriate fixed-wing criteria will be applied, except as noted for shoulders or for STOVL aircraft requirements.

**5-7.2 Taxiway Shoulders.**

A paved shoulder will be provided at dual use airfields. Shoulder widths may be increased beyond the requirement in Table 5-3 when necessary to accommodate dual operations with fixed-wing aircraft.

**Table 5-3. Rotary-Wing Taxiway Shoulders**

Table 5-3. Rotary-Wing Taxiway Shoulders			
Item		Requirement	Remarks
No.	Description		
1	Total width of shoulder (paved and unpaved)	7.5 m (25 ft)	May be increased when necessary to accommodate dual operations with fixed-wing aircraft
2	Paved shoulder width adjacent to all rotary-wing taxiways	7.5 m (25 ft)	May be increased when necessary to accommodate dual operations with fixed-wing aircraft. See Note 4 where fire hydrants are installed along apron shoulders. Navy and Marine Corps CH-53 & V-22: Increase shoulder width to provide minimum 30 m (100 ft) total paved width (taxiways and shoulders).
3	Longitudinal grade	Variable	Conform to the longitudinal grade of the abutting primary pavement.
4	Transverse grade	2.0% min 4.0% max	Slope downward from the edge of the pavement.
5	Grades within clear area (adjacent to paved shoulder)	(a) 40 mm (1.5 in) drop-off at edge of paved shoulder. (b) 2% min 5% max	Slope downward from the edge of the shoulder.  For additional grading criteria in primary surface and clear areas, see Chapter 3 for fixed-wing facilities and Chapter 4 for rotary-wing facilities.

**NOTES:**

1. Metric units apply to new airfield construction and, where practical, modification to existing airfields and heliports, as discussed in paragraph 1-3.4.

2. The criteria in this manual are based on aircraft specific requirements and are not direct conversions from inch-pound (English) dimensions. Inch-pound units are included only as a reference to the previous standard.
3. Airfield and heliport imaginary surfaces and safe wingtip clearance dimensions are shown as a direct conversion from inch-pound to SI units.
4. Hydrants are to be "30-35 ft" outside the "Apron" edge. Provide paved access lane to fire hydrants where needed.

## **5-8 TAXIWAY INTERSECTION CRITERIA.**

To prevent the main gear of an aircraft from coming dangerously close to the outside edge of the taxiway during a turn, fillets and lead-ins to fillets are provided at taxiway intersections. When an aircraft turns at an intersection, the nose gear of the aircraft usually follows the painted centerline marking. The main gears, located to the rear of the nose gear, do not remain a constant distance from the centerline stripe during the turn due to the physical design of the aircraft. The main gears pivot on a shorter radius than does the nose gear during a turn. Intersections should be designed to ensure that the main gear wheels stay a minimum of 3 m (10 ft) from the pavement edge. Intersection geometry can be determined using wheel-tracking simulation tools, or using the criteria described in paragraphs 5-8.1 and 5-8.2.

For rotary-wing taxiway intersections, use Table 5-4 and Table 5-5 with the appropriate taxiway width to determine the fillet dimensions.

For additional support see CE Dash Airfield geometrics page for report "Developing Aircraft Turning Templates" at [https://cs2.eis.af.mil/sites/10159/SitePages/Service%20Page.aspx?Service=Airfield Geometry](https://cs2.eis.af.mil/sites/10159/SitePages/Service%20Page.aspx?Service=Airfield%20Geometry) .

### **5-8.1 Fillet-Only Dimensions.**

Fillets are required at runway-taxiway and taxiway-taxiway intersections. Fillets at runway-taxiway intersections are arcs installed in accordance with Table 5-4 and Figure 5-4. Fillets at taxiway-taxiway intersections are installed in accordance with Table 5-5 and Figure 5-5. Centerline and fillet radii used for these figures and tables are based on a 45.72-m (150-ft) centerline turning radius for runway/taxiway intersections and a 38.1-m (125-ft) centerline turning radius for taxiway/taxiway intersections using the geometry of the C-5 aircraft and a taxiway width of 22.86 m (75 ft). Larger centerline turning radii, other aircraft (e.g. Boeing 747-800 or Airbus A380), or narrower taxiways may require larger fillets; therefore, the designer must consider the most demanding situation and ensure the 3 m (10 ft) edge safety margin is provided. Use of these specific criteria are not mandatory.

**Table 5-4. Runway/Taxiway Intersection Fillet Radii**

Table 5-4. Runway/Taxiway Intersection Fillet Radii				
Runway Width	Taxiway Width	Fillet Radius	Fillet Radius	Fillet Radius
W	T	R1	R2	R3
More than 22.86 m (75 ft) but less than 45.72 m (150 ft)	22.86 m (75 ft)	45.72 m (150 ft)	38.1 m (125 ft)	76.2 m (250 ft)
45.72 m (150 ft) or more	22.86 m (75 ft)	38.1 m (125 ft)	38.1 m (125 ft)	76.2 m (250 ft)
More than 22.86 m (75 ft) but less than 45.72 m (150 ft)	15.24 m (50 ft)	18.29 m (60 ft)	18.29 m (60 ft)	18.29 m (60 ft)
45.72 m (150 ft) or more	15.24 m (50 ft)	15.24 m (50 ft)	15.24 m (50 ft)	15.24 m (50 ft)
More than 22.86 m (75 ft) but less than 45.72 m (150 ft)	12.19 m (40 ft)	15.24 m (50 ft)	15.24 m (50 ft)	15.24 m (50 ft)
45.72 m (150 ft) or more	12.19 m (40 ft)	15.24 m (50 ft)	15.24 m (50 ft)	15.24 m (50 ft)

**Table 5-5. Taxiway/Taxiway Intersection and Taxiway Turns Fillet Radii**

Table 5-5. Taxiway/Taxiway Intersection and Taxiway Turns Fillet Radii			
Taxiway Width	Fillet Radius	Fillet Radius	Fillet Radius
W	R4	R5	R6
22.86 m (75 ft)	45.72 m (150 ft)	38.1 m (125 ft)	76.2 m (250 ft)
15.24 m (50 ft)	18.29 m (60 ft)	12.19 m (40 ft)	27.43 m (90 ft)
12.19 m (40 ft)	18.29 m (60 ft)	12.19 m (40 ft)	27.43 m (90 ft)

Figure 5-4. Runway/Taxiway Intersection Fillets

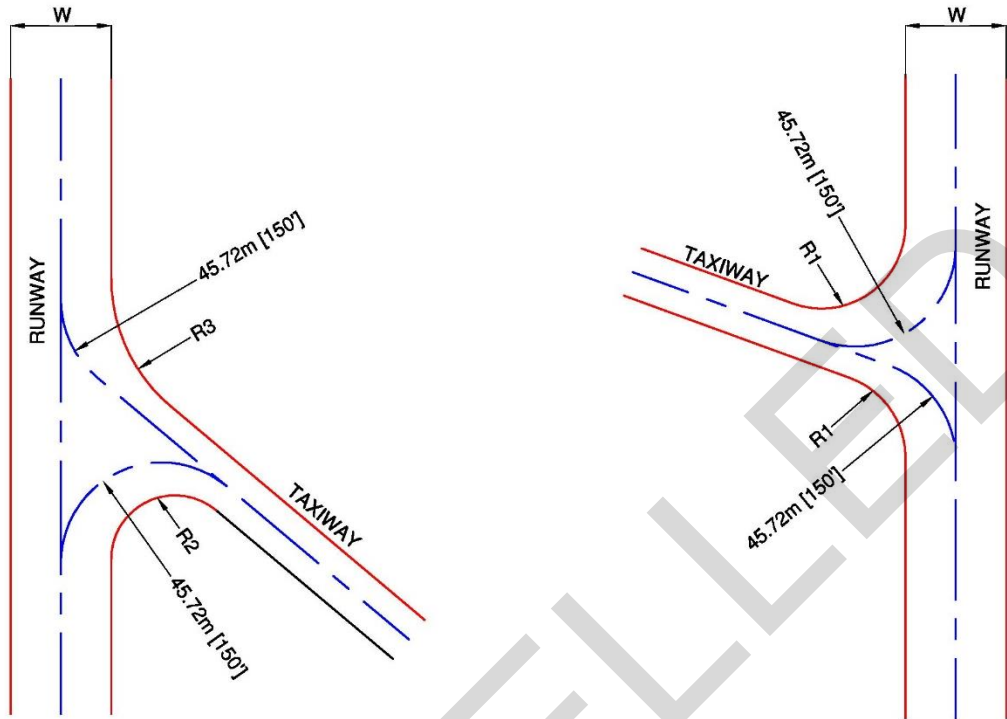

MORE THAN 135 AND  
LESS THAN 45 DEGREE  
INTERSECTION  
N.T.S.

LESS THAN 135 AND  
MORE THAN 45 DEGREE  
INTERSECTION  
N.T.S.

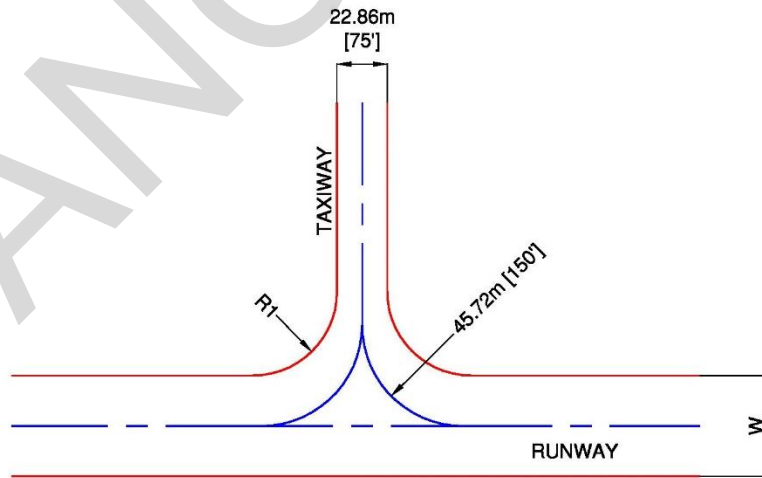

90 DEGREE  
RUNWAY-TAXIWAY  
INTERSECTION  
N.T.S.

Figure 5-5. Taxiway/Taxiway Intersection Fillets

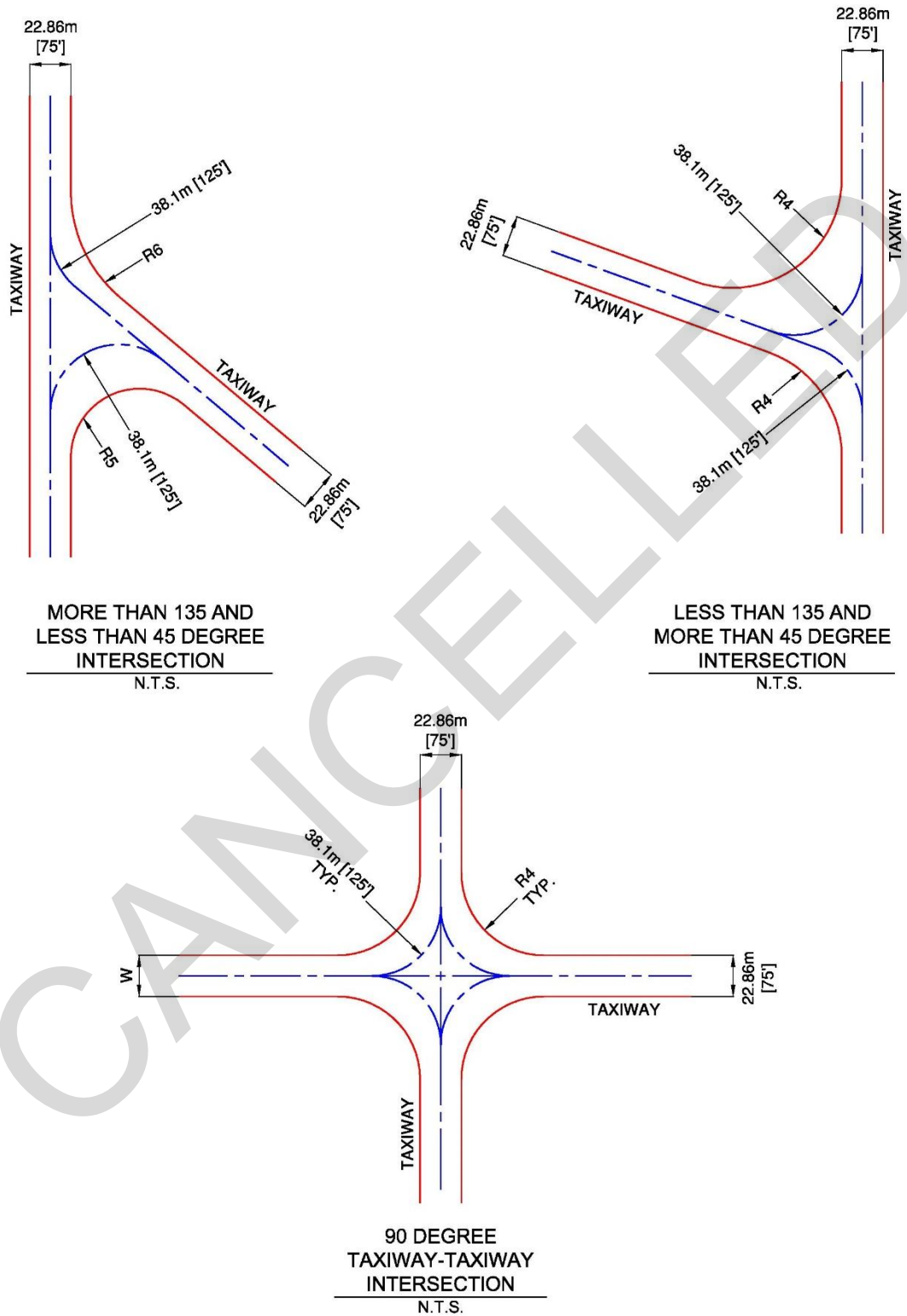



## **5-9 HIGH-SPEED RUNWAY EXITS.**

If peak operations are expected to exceed 30 takeoffs and landings per hour, aircraft may be required to exit runways at greater than normal taxi speeds to maintain airfield capacity. In these cases, an acute-angle exit taxiway may be required. Air Force designers should contact their MAJCOM pavements engineer or Headquarters Air Force Civil Engineer Center for assistance. Army designers should contact the U.S. Army Corps of Engineers Transportation Systems Center (USACE-TSC). Navy and Marine Corps designers may use the criteria for transport aircraft provided in FAA AC 150/5300-13.

## **5-10 APRON ACCESS TAXIWAYS.**

Apron access taxiways are provided for aircraft access onto an apron. The number of apron access taxiways should allow sufficient capacity for departing aircraft. The apron access taxiways should be located to enhance the aircraft's departing sequence and route.

### **5-10.1 Parking Aprons.**

The minimum number of apron access taxiways for any parking apron will be two. For the USAF, the minimum may be one if a single access taxiway will not inhibit planned operations.

### **5-10.2 Fighter Aircraft Aprons.**

Three apron access taxiways should be provided for aprons with over 24 parked fighter aircraft. Four entrance taxiways should be provided for aprons with over 48 parked fighter aircraft.

## **5-11 SHOULDERS.**

Shoulders are provided along a taxiway to allow aircraft to recover if they leave the paved taxiway. Paved shoulders prevent erosion caused by jet blast, support an occasional aircraft that wanders off the taxiway, support vehicular traffic, and reduce maintenance of unpaved shoulder areas.

### **5-11.1 Fixed-Wing Taxiways.**

The shoulder for fixed-wing taxiways may be either paved or unpaved, depending on the agency, class of runway, and type of aircraft. Criteria for fixed-wing taxiway shoulders, including widths and grading requirements to prevent the ponding of storm water, are presented in Table 5-1. See Paragraph 2-12 for requirements for designing buried utility structures in shoulders.

### **5-11.2 Rotary-Wing Taxiways.**

Paved shoulders are required adjacent to rotary-wing taxiways to prevent blowing dust and debris due to rotor-wash. The criteria for a rotary-wing taxiway shoulder layout, including shoulder width, cross slopes, and grading requirements, are presented in Table 5-3.

## 5-12 TOWWAYS.

A towway is used to tow aircraft from one location to another or from an apron to a hangar.

### 5-12.1 Dimensions.

Table 5-6 presents the criteria for towway layout and design, including clearances, slopes, and grading dimensions. When designing for access to a hangar, flare the pavement to the width of the hangar door from a distance beyond the hangar sufficient to allow maintenance personnel to turn the aircraft around.

### 5-12.2 Layout.

A typical transverse cross-section of a towway is shown in Figure 5-6.

### 5-12.3 Existing Roadway.

When existing roads or other pavements are modified for use as towways, provide for necessary safety clearances, pavement strengthening (if required), and all other specific requirements set forth in Table 5-6 and Figure 5-6.

## 5-13 HANGAR ACCESS.

The pavement that allows access from the apron to the hangar is referred to as a “hangar access apron” and is discussed in more detail in Chapter 6.

**Table 5-6. Towways**

Table 5-6. Towways				
Item		Class A Runway	Class B Runway	Remarks
No.	Description	Requirement		
1	Width	(outside gear width of towed mission aircraft) +3 m (10 ft)		Army and Air Force facilities 1.5 m (5 ft) on each side of gear
		11 m (36 ft)		Navy and Marine Corps facilities for carrier aircraft
		12 m (40 ft)		Navy and Marine Corps facilities for patrol and transport aircraft
		10.7 m (35 ft)		Navy and Marine Corps facilities for rotary-wing aircraft

Table 5-6. Toweys				
Item		Class A Runway	Class B Runway	Remarks
No.	Description	Requirement		
2	Total width of shoulders (paved and unpaved)	7.5 m (25 ft)		
3	Paved shoulder width	Not Required		If provided: 2.0% min. and 4.0% max.
4	Longitudinal grade of towway	Max 3.0%		Grades may be both positive and negative but must not exceed the limit specified.
5	Rate of longitudinal grade change per 30 m (100 ft)	Max 1.0%		The minimum distance between two successive PI is 150 m (500 ft). Changes are to be accomplished by means of vertical curves. For the Air Force and Army, up to a 0.4% change in grade is allowed without a vertical curve. A vertical curve is not necessary where a taxiway crosses a runway or taxiway crown.
6	Longitudinal sight distance	N/A (See note 1.)		
7	Transverse grade	Min 2.0% Max 3.0%		Pavement crowned at towway centerline Slope pavement downward from centerline of towway.
8	Towway turning radius	46 m (150 ft) radius		Criteria presented here are for straight sections of towway. Pavement width and horizontal clearance lines may need to be increased at horizontal curve locations, based on aircraft alignment on the horizontal curve.
9	Fillet radius at intersections	30 m (100 ft) radius		
10	Transverse grade of unpaved shoulder	(a) 40 mm (1.5 in) drop-off at edge of pavement, +/- 13 mm (0.5 in). (b) 2.0% min, 4.0% max.		
11	Horizontal clearance from towway centerline to fixed or mobile obstacles	The greater of: ( $\frac{1}{2}$ the wing span width of the towed mission aircraft + 7.6 m [25 ft]); or the minimum of 18.25 m (60 ft)		Army and Air Force facilities for fixed-wing aircraft
		15 m (50 ft)		Navy and Marine Corps facilities for carrier aircraft
		23 m (75 ft)		Navy and Marine Corps facilities for patrol and transport aircraft

Table 5-6. Toweys				
Item		Class A Runway	Class B Runway	Remarks
No.	Description	Requirement		
		14 m (45 ft)		Army, Navy, and Marine Corps facilities for rotary-wing aircraft
12	Vertical clearance from towway pavement surface to fixed or mobile obstacles	(Height of towed mission aircraft) + 3 m (10 ft)		Army and Air Force facilities
		7.5 m (25 ft)		Navy and Marine Corps facilities for carrier aircraft
		14 m (45 ft)		Navy and Marine Corps facilities for patrol and transport aircraft
		9 m (30 ft)		Navy and Marine Corps facilities for rotary-wing aircraft
13	Grade (area between towway shoulder and towway clearance line)	Min of 2.0% prior to channelization Max 10%. (See note 2.)		

**NOTES:**

1. N/A = not applicable
2. Bed of channel may be flat.
3. Metric units apply to new airfield construction and, where practical, modification to existing airfields and heliports, as discussed in paragraph 1-3.4.
4. The criteria in this manual are based on aircraft specific requirements and are not direct conversions from inch-pound (English) dimensions. Inch-pound units are included only as a reference to the previous standard.
5. Airfield and heliport imaginary surfaces and safe wingtip clearance dimensions are shown as a direct conversion from inch-pound to SI units.

Figure 5-6. Towway Criteria

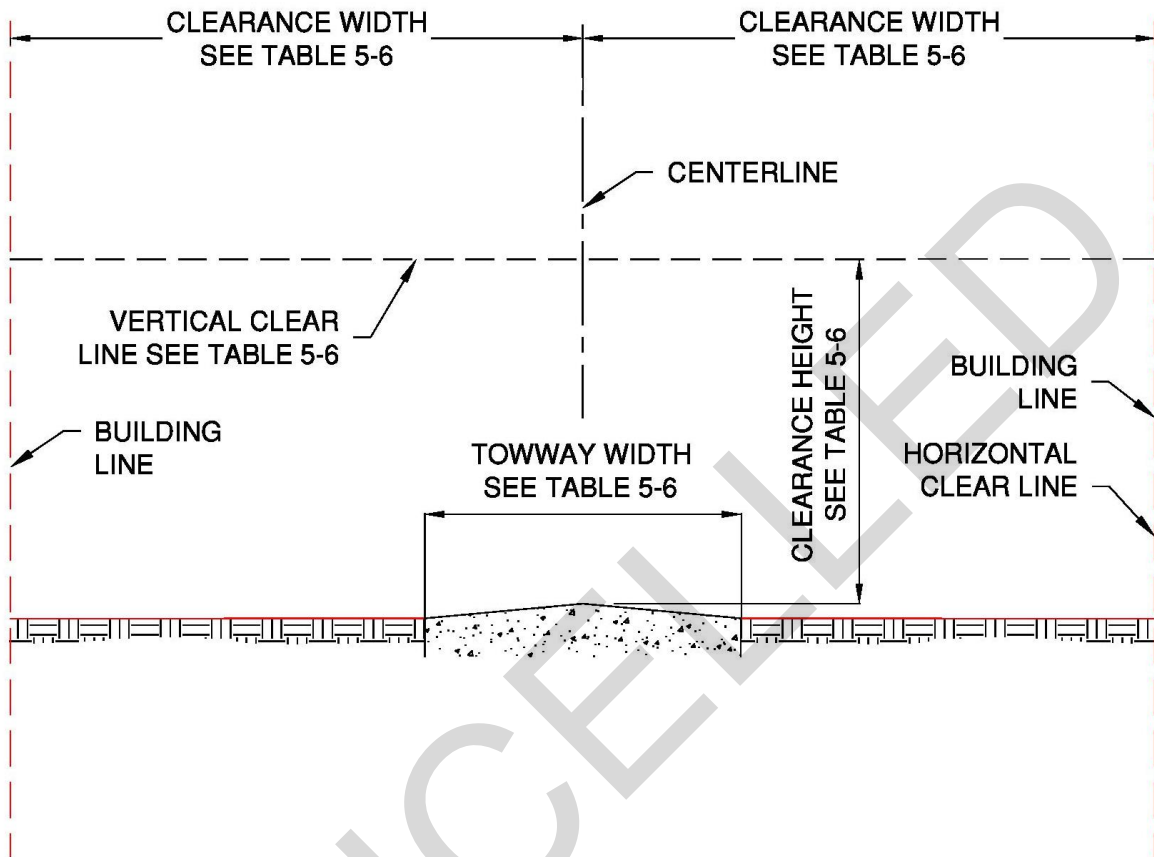

TYPICAL CROSS SECTION  
(SHOWING SAFETY CLEARANCES)  
N.T.S.

Table 5-7. Taxitraks

Table 5-7. Taxitraks			
Item		Requirement	Remarks
No.	Description		
1	Total width of shoulder (paved and unpaved)	15 m (50 ft)	
2	Paved shoulder width adjacent to all operational pavements	7.5 m (25 ft)	Match Runway criteria by airfield. Air Force taxiways devoted exclusively for fighter and trainer aircraft may reduce to 3m (10 ft)
3	Clearance from centerline to fixed and mobile obstacles	Min 45.72 m (150 ft)	See Table 3-2, item 12, for obstacle definition.
4	Longitudinal grade	-3.0% min 3.0% max	
5	Transverse grade	1.5% min 2.0% max	Slope downward from the centerline.
6	Transverse grade - Shoulder	1.5% min 3.0% max	Slope downward from the edge of the pavement.
7	Horizontal Curves	76 m (250 ft)	

**NOTES:**

1. Metric units apply to new airfield construction and, where practical, modification to existing airfields and heliports, as discussed in paragraph 1-3.4.
2. The criteria in this manual are based on aircraft specific requirements and are not direct conversions from inch-pound (English) dimensions. Inch-pound units are included only as a reference to the previous standard.

## CHAPTER 6 APRONS AND OTHER PAVEMENTS

### 6-1 CONTENTS.

This chapter presents design standards for fixed- and rotary-wing aircraft parking aprons, access aprons, maintenance pads, and wash racks. It provides minimum wingtip clearance requirements, grades, and lateral clearance standards, as well as typical aircraft parking arrangements. The general principles of this chapter apply to the Navy and Marine Corps. Specific data for Navy and Marine Corps aprons is contained in the referenced publications. See Figures 6-43 and 6-44 and Tables 6-7 through 6-10 for Navy and Marine Corps aircraft parking apron criteria (taken from UFC 2-000-5N).

### 6-2 APRON REQUIREMENTS.

Aprons must provide sufficient space for parking fixed- and rotary-wing aircraft. They should be sized to allow safe movement of aircraft under their own power. During design, consider the effects of jet blast turbulence and temperature. Programming requirements for Air Force aviation facilities are provided in AFMAN 32-1084. Requirements for Navy and Marine Corps aviation facilities are contained in UFC 2-000-05N and UFC 3-260-02. The general principles of this chapter apply to the Navy and the Marine Corps. Specific data on Navy/Marine Corps aprons is contained in the referenced publications. Use High Temperature Concrete and neoprene joint sealants in locations where stationary V-22 nacelle exhaust exposure is ten minutes or greater. This will likely include but is not limited to fuel pits, warm-up areas, and aprons. Rinse facilities supporting V-22s must also include High Temperature Concrete due to heat and vapor flux.

### 6-3 TYPES OF APRONS AND OTHER PAVEMENTS.

Listed here are types of aprons and other aviation facilities:

- Aircraft parking apron
- Transient parking apron
- Mobilization apron
- Aircraft maintenance apron
- Hangar access apron
- Warm-up pad (holding apron)
- Unsuppressed power check pads
- Arm/dearm pad
- Compass calibration pad
- Hazardous cargo pad

- Alert pad
- Aircraft wash rack

#### **6-4 AIRCRAFT CHARACTERISTICS.**

Dimensional characteristics of various military, civil, and commercial fixed- and rotary-wing aircraft are available in TSC Report 13-2 (Aircraft Characteristics for Military Aircraft) and in TSC Report 13-3 (Aircraft Characteristics for Selective Commercial Aircraft).

#### **6-5 PARKING APRON FOR FIXED-WING AIRCRAFT.**

Fixed-wing parking at an aviation facility may consist of separate aprons for parking operational aircraft, transient aircraft, and transport aircraft, or an apron for consolidated parking.

##### **6-5.1 Location.**

Parking aprons should be located near and contiguous to maintenance and hangar facilities. Do not locate them within runway and taxiway lateral clearance distances. A typical parking apron is illustrated in Figure 6-1.

##### **6-5.2 Size.**

As a general rule, there are no standard sizes for aircraft aprons. Aprons are individually designed to support aircraft and missions at specific facilities. The actual dimensions of an apron are based on the number of authorized aircraft, the maneuvering space, and the type of activity that the apron serves. Air Force allowances are provided in AFMAN 32-1084. Army facility authorizations are discussed in RPLANS and applicable programming directives. The ideal apron size affords the maximum parking capacity with a minimum amount of paving. Generally, this is achieved by reducing the area dedicated for use as taxilanes by parking aircraft perpendicular to the long axis of the apron.

##### **6-5.3 Army Parking Apron Layout.**

###### **6-5.3.1 Variety of Aircraft.**

Where there are a large variety of fixed-wing aircraft types, fixed-wing aircraft mass parking apron dimensions will be based on the C-12J (Huron). The C-12J parking space width is 17 m (55 ft), and the parking space length is 18.25 m (60 ft).

###### **6-5.3.2 Specific Aircraft.**

If the assigned aircraft are predominantly one type, the mass parking apron will be based on the specific dimensions of that aircraft.

###### **6-5.3.3 Layout.**



Figure 6-2 illustrates a parking apron. These dimensions can be tailored for specific aircraft, including the C-12J.

**6-5.4 Air Force Parking Apron Layout.**

Parking apron dimensions for Air Force facilities will be based on the specific aircraft assigned to the facility and the criteria presented in AFMAN 32-1084. A typical mass parking apron should be arranged in rows as shown in Figure 6-2.

**6-5.5 Layout for Combined Army and Air Force Parking Aprons.**

Parking apron dimensions for combined Army and Air Force facilities will be based on the largest aircraft assigned to the facility.

**6-5.6 Tactical/Fighter Parking Apron Layout.**

The recommended tactical/fighter aircraft parking arrangement is to park aircraft at a 45-degree angle as discussed in AFMAN 32-1084. Arranging these aircraft at a 45-degree angle may be the most economical method for achieving the clearance needed to dissipate jet blast temperatures and velocities to levels that will not endanger aircraft or personnel (Figure 6-3). Jet blast relationships for tactical and fighter aircraft are discussed in TSC Report 13-2.

Figure 6-1. Apron Nomenclature and Criteria

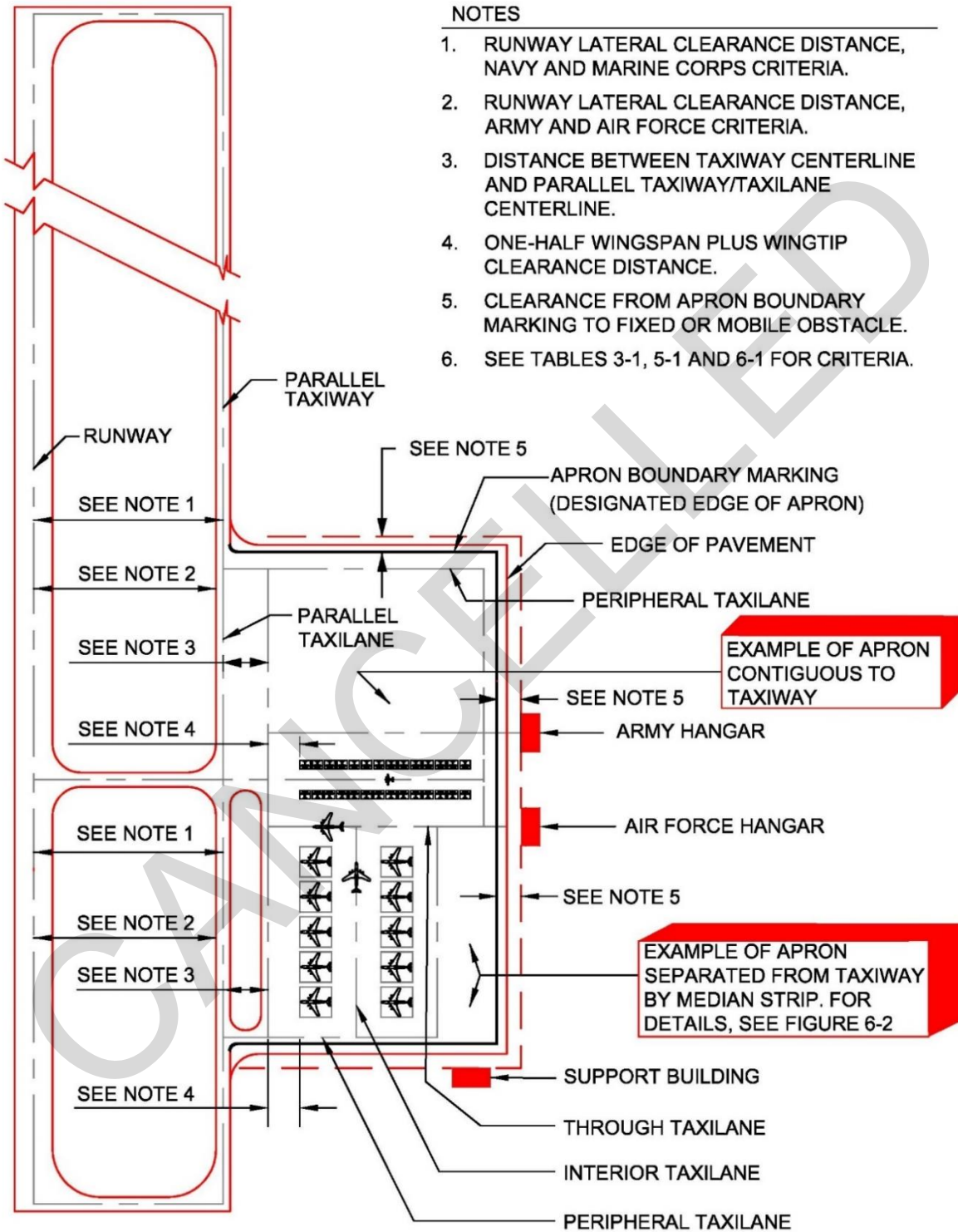
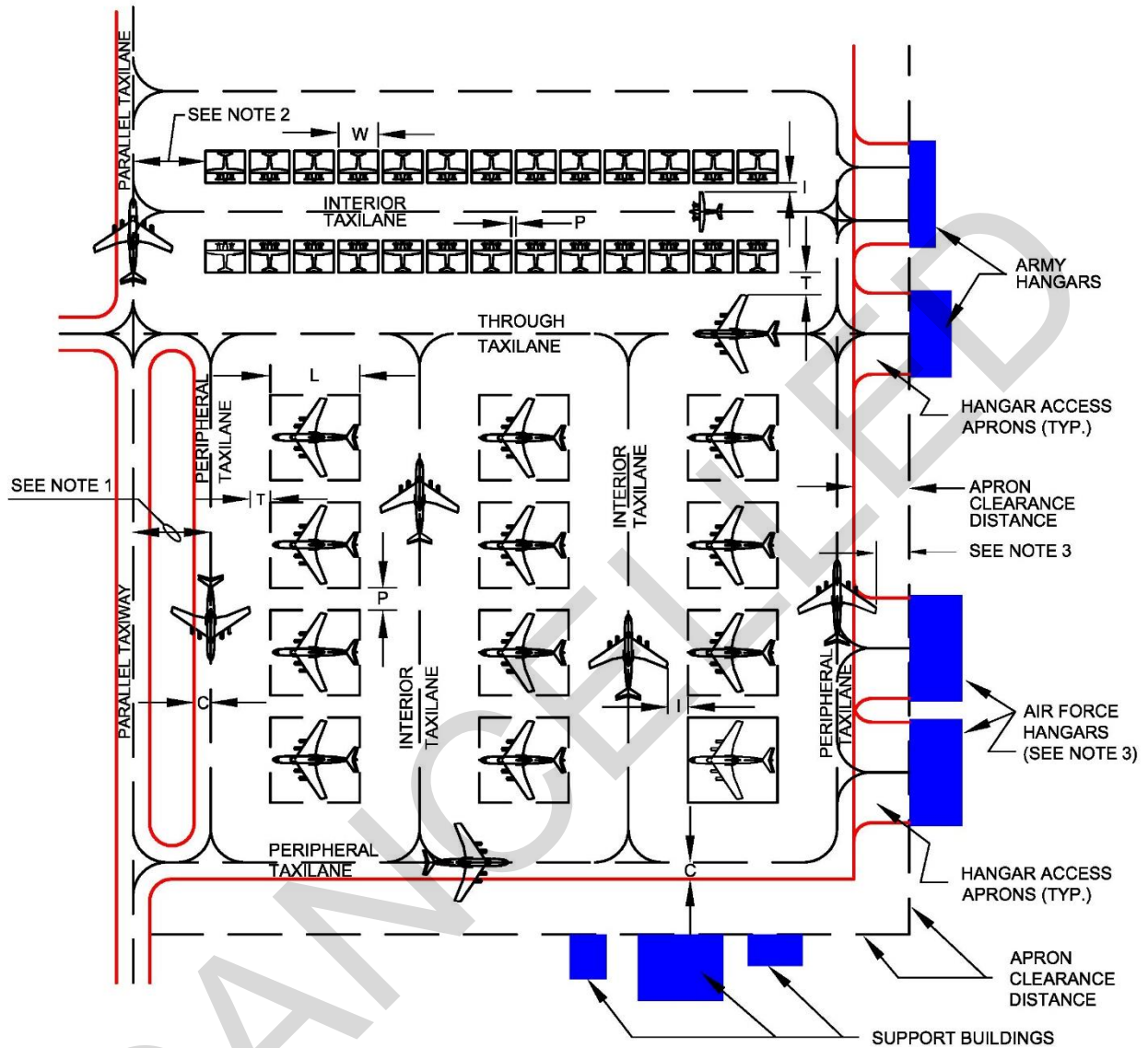

Figure 6-2. Army and Air Force Parking Plan



LEGEND

- W – AIRCRAFT WIDTH
- L – AIRCRAFT LENGTH
- I – WINGTIP CLEARANCE FOR INTERIOR TAXILANE (MIN. TAXI CLEARANCE)
- T – WINGTIP CLEARANCE FOR THROUGH AND PRIMARY PERIPHERAL TAXILANES
- P – WINGTIP CLEARANCE FOR PARKED AIRCRAFT
- C – DISTANCE FROM PERIPHERAL TAXILANE CENTERLINE TO APRON EDGE

NOTES:

1. TAXIWAY CLEARANCE DISTANCE AT FACILITIES WITH PARALLEL TAXIWAYS; SEE TABLE 5-1, ITEM 11.
2. SEE TABLE 6-1 FOR DIMENSIONAL DEFINITIONS.
3. FOR AIR FORCE: INSURE MINIMUM WINGTIP CLEARANCE IS PROVIDED TO HANGARS OR OTHER PERMISSIBLE DEVIATIONS (SEE TABLE 6-1 ITEMS 5, 6 AND 15, AND APPENDIX B, SECTION 13).

Figure 6-3. Apron with Diagonal Parking

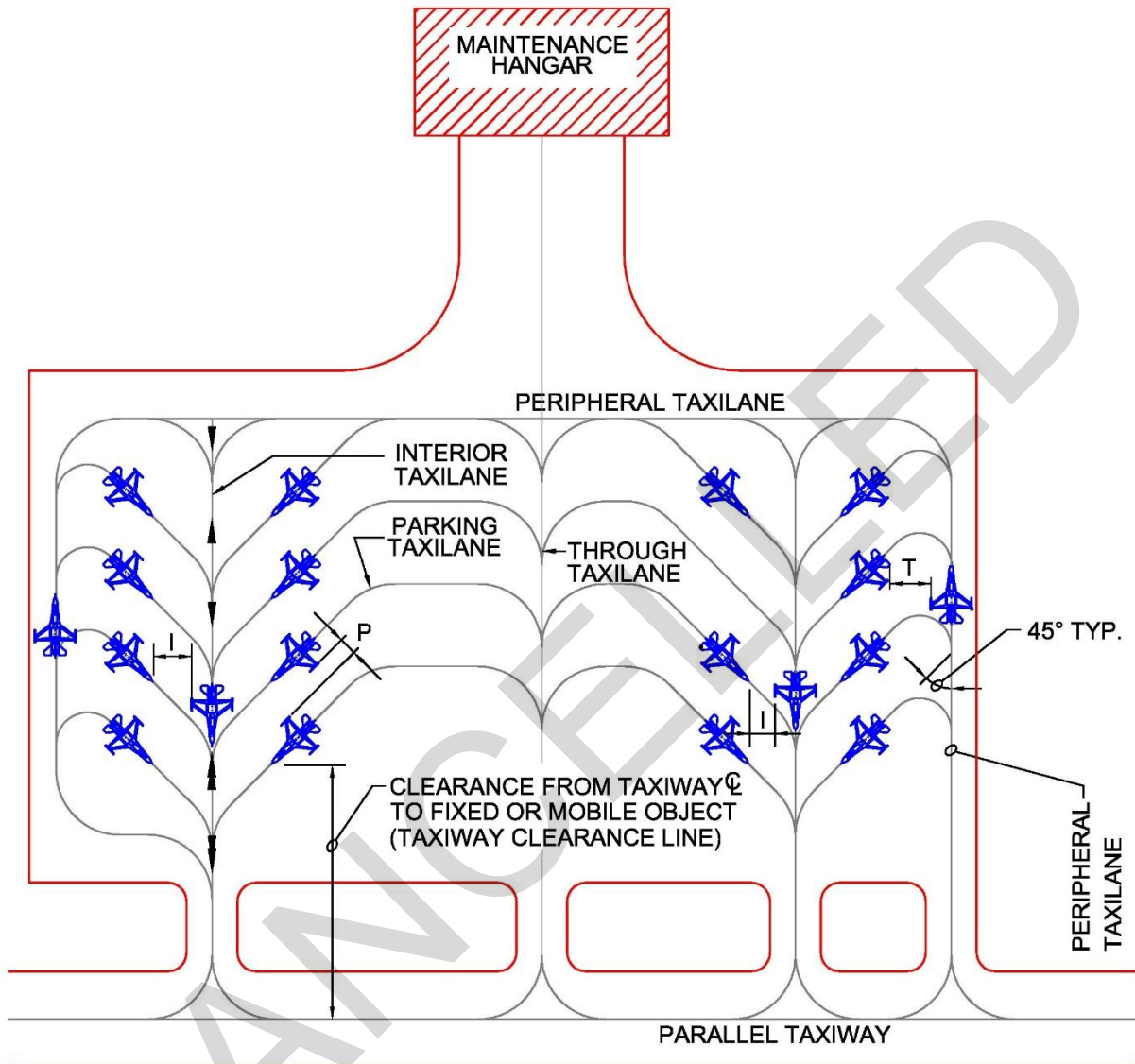

**NOTES**

1. SEE TABLE 6-1 FOR DIMENSIONAL CRITERIA.
2. THIS PARKING ARRANGEMENT IS SHOWN FOR INFORMATION ONLY AND NOT NECESSARILY AN IDEAL PARKING ARRANGEMENT.

### **6-5.7 Refueling Considerations.**

Layout of aircraft parking locations and taxilanes should consider aircraft taxiing routes when an aircraft is refueled. Refueling operations should not prevent an aircraft from leaving the parking apron. Two routes in and out of the apron may be required. During refueling, active ignition sources such as sparks from ground support equipment or jet engines (aircraft) are prohibited from a zone around the aircraft. The Army and Air Force refer to this zone as the fuel servicing safety zone (FSSZ). The Navy and Marine Corps refer to this zone as the refueling safety zone (RSZ). An example of the RSZ around a fixed-wing aircraft is shown in Figure 6-4. The safety zone is the area within 15 m (50 ft) of a pressurized fuel carrying servicing component (e.g., servicing hose, fuel nozzle, single-point receptacle (SPR), hydrant hose car, ramp hydrant connection point) and 7.6 m (25 ft) around aircraft fuel vent outlets. The FSSZ is established and maintained during pressurization and movement of fuel. For additional information, see Air Force technical order (T.O.) 00-25-172. For additional Navy information, see MIL-HDBK-274. Minimum requirements for the design and maintenance of the drainage system of aircraft fueling ramps are given in National Fire Protection Association (NFPA) 415.

### **6-5.8 Parking Dimensions.**

Table 6-1 presents the minimum geometric criteria for fixed-wing apron design. When designing new aprons for AMC bases hosting C-5 and C-17 aircraft, provide 15.3 m (50 ft) of wingtip separation. EXCEPTION: When you are rehabilitating an existing apron, provide the maximum wingtip separation the existing apron size will allow up to 15.3 m (50 ft), but not less than 7.7 m (25 ft). This additional separation is both desirable and permitted. At non-AMC bases, the maximum separation that can reasonably be provided for these aircraft is desirable.

#### **6-5.8.1 Jet Blast Considerations.**

The clearances listed in Table 6-1 do not consider the effects of temperature and velocity due to jet blast. The effects of jet blast and the minimum standoff distance to the edge of the pavement are described in Appendix B, Section 7.

#### **6-5.8.2 Cargo Loading Considerations.**

Consider the effects of jet blast on aircraft loading operations and cargo storage locations when you design a layout for parking cargo aircraft.

### **6-5.9 Tie-downs and Mooring Points.**

Tie-downs or mooring points are required. See Appendix B, Section 11, for grounding requirements.

Figure 6-4. Truck Refueling Safety Zone Example

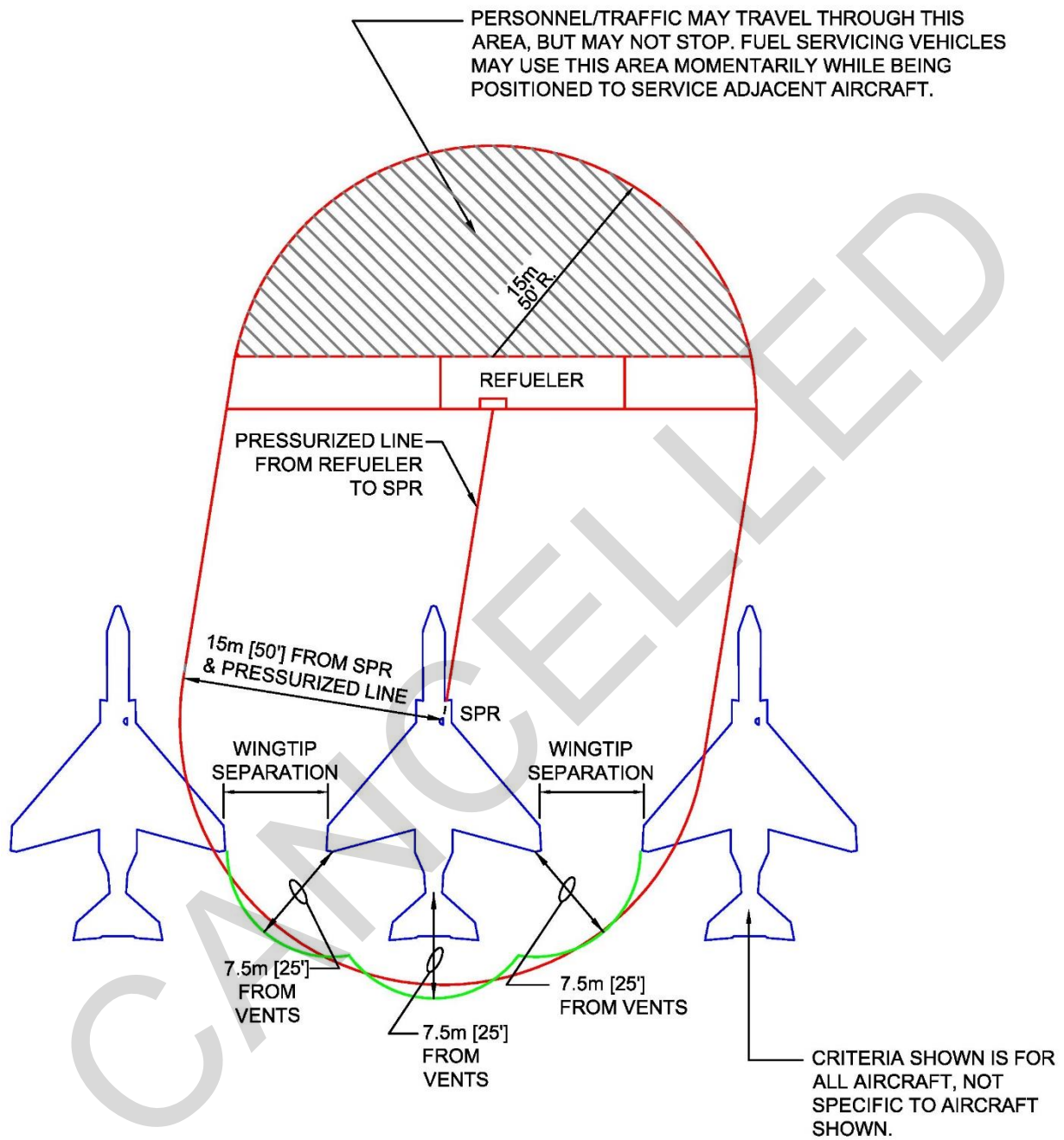

N.T.S.

Table 6-1. Fixed-Wing Aprons

Table 6-1. Fixed-Wing Aprons				
Item		Class A Runway	Class B Runway	Remarks
No.	Description	Requirement		
1	Size and configuration	<p>Variable</p> <p>For Army and Air Force requirements, see the criteria listed below and AFMAN 32-1084.</p> <p>For Navy and Marine Corps requirements, see UFC 2-000-05N .</p>		As a general rule there are no standard sizes for aprons. They are individually designed to support specific aircraft uses. The dimensions are determined by the number and type of aircraft involved, the function of the apron, the maneuvering characteristics of the aircraft, the jet blast of the aircraft, and the degree of unit integrity to be maintained. Other determinants are the physical characteristics of the site, the relationship of the apron area to other airfield facilities, and the objective of the comprehensive plan.
2	Parking space width ("W")	Design aircraft wingspan		Army and Air Force airfields. For V-22 parking dimensions, see Figure 6-44.
3	Parking space length ("L")	Design aircraft length		Army and Air Force airfields. For V-22 parking dimensions, see Figure 6-44.
4	Wingtip clearance of parked aircraft ("P")	3.1 m (10 ft)		Army and Air Force airfields, aircraft with wingspans up to 33.5 m (110 ft) For V-22 wingtip clearances, see Figure 6-44.
		6.1 m (20 ft)		Army and Air Force airfields, aircraft with wingspans of 33.5 m (110 ft) or more except as noted below See note 1 for USAF.
		7.7 m (25 ft)		Army and Air Force airfields, transient aprons, C-5 and C-17 aircraft (also see paragraph 6-5.8) See note 1 for USAF.
		15.3 m (50 ft)		Army and Air Force airfields, KC-10, KC-46 and KC-135 aircraft to accommodate refueling and defueling operations. See note 1 for USAF.

**Table 6-1. Fixed-Wing Aprons**

Table 6-1. Fixed-Wing Aprons				
Item		Class A Runway	Class B Runway	Remarks
No.	Description	Requirement		
5	Wingtip clearance of aircraft on interior or secondary peripheral taxilanes ("I")	6.1 m (20 ft)		Army and Air Force airfields, aircraft with wingspans up to 33.5 m (110 ft), except transient aprons. For V-22 wingtip clearances, see Figure 6-44. Taxilanes that provide access to individual parking spots or hangars are considered secondary taxi routes. See note 1 for USAF.
		7.7 m (25 ft)		Army and Air Force airfields, transient aprons. Taxilanes that serve multiple types of aircraft or serve to provide circulation beyond access to individual parking spots or hangars are considered primary facilities. See note 1 for USAF. For V-22 wingtip clearances, see Figure 6-44.
		9.2 m (30 ft)		Army and Air Force airfields, aircraft with wingspans of 33.5 m (110 ft) or more, except transient aprons. Taxilanes that serve multiple types of aircraft or serve to provide circulation beyond access to individual parking spots or hangars are considered primary facilities. See note 1 for USAF.
6	Wingtip clearance of aircraft on through or primary peripheral taxilanes ("T")	9.2 m (30 ft)		Army and Air Force airfields, aircraft with wingspans up to 33.5 m (110 ft). For V-22 wingtip clearances, see Figure 6-44. Taxilanes that serve multiple types of aircraft or serve to provide circulation beyond access to individual parking spots or hangars are considered primary facilities. See note 1 for USAF.
		Min 15.3 m (50 ft)		Army and Air Force airfields, aircraft with wingspans of 33.5 m (110 ft) or more. Taxilanes that serve multiple types of aircraft or serve to provide circulation beyond access to individual parking spots or hangars are considered primary facilities. See note 1 for USAF.



Table 6-1. Fixed-Wing Aprons				
Item		Class A Runway	Class B Runway	Remarks
No.	Description	Requirement		
7	Distance from peripheral taxilane centerline to the outside edge of the apron boundary marking ("C")	7.7 m (25 ft)		Army and Air Force airfields Designed for aircraft with wingspan up to 33.5 m (110 ft). For V-22 wingtip clearances, see Figure 6-44.
		11.5 m (37.5 ft)		Army and Air Force airfields Designed for aircraft with wingspan of 33.5 m (110 ft) and greater
8	Clear distance around aircraft during fueling (see paragraph 6-5.7.)	7.7 m (25 ft)		Around aircraft fuel vent outlets (see T.O. 00-25-172).
		15.3 m (50 ft)		From a pressurized fuel carrying servicing component (see T.O. 00-25-172).
		See Remarks		Consider refueling operations when locating taxilanes.
9	Grades in the direction of drainage	Min 0.5% Max 1.5%		Avoid surface drainage patterns with numerous or abrupt grade changes that can produce excessive flexing of aircraft and structural damage. Lateral and transverse slopes must be combined to derive maximum slope in the direction of drainage. (i.e., the square root of the transverse slope squared plus longitudinal slope squared is equal to the slope in the direction of drainage.)  For the Air Force, no grade changes are allowed for individual parking positions within the aircraft block dimensions (not including clearance distances) of the design aircraft. Exceptions are allowed for fuel hydrant pits.
10	Width of shoulders (total width including paved and unpaved)	7.5 m (25 ft)	15 m (50 ft)	Army and Air Force airfields
11	Paved width of shoulders	7.5 m (25 ft)	7.5 m (25 ft)	Army and Air Force airfields not otherwise specified. For apron shoulders where fire hydrants must be installed, see Note 5 and Appendix B, Section 13, for the minimum set back from the taxilane centerline.

Table 6-1. Fixed-Wing Aprons				
Item		Class A Runway	Class B Runway	Remarks
No.	Description	Requirement		
		N/A	15 m (50 ft)	Army and Air Force airfields that accommodate B-52, C-5, E-4, and 747 aircraft. For apron shoulders where fire hydrants must be installed, see Note 5 and Appendix B, Section 13, for the minimum set back from the taxiway centerline.
12	Longitudinal grade of shoulders	Variable		Conform to longitudinal grade of the abutting primary pavement.
13	Transverse grade of paved shoulder	Min 2.0% Max 4.0%		Army airfields and Air Force airfields not otherwise specified
		N/A	Min 1.5% Max 2.0%	Air Force airfields that accommodate B-52 aircraft
14	Transverse grade of unpaved shoulders	N/A	(a) 40 mm (1.5 in) drop-off at edge of paved shoulder, +/- 13 mm (0.5 in). (b) 2.0% min, 4.0% max.	Unpaved shoulders shall be graded to provide positive surface drainage away from paved surfaces.
15	Clearance from apron boundary marking to fixed or mobile obstacles	Variable		<p>Compute this distance by multiplying 0.5 x the wingspan of the most demanding aircraft that will use the apron and add the appropriate wingtip clearance required by item 5 or 6. Then subtract the distance from the taxiway centerline to the outside edge of the apron boundary marking (item 7) to find the required clear distance.</p> <p>This distance is to be clear of all fixed and mobile obstacles except as specifically noted in Appendix B, Section 13, even if there is no peripheral taxiway along the edge of apron. This clear distance is required for safety purposes.</p> <p><b>NOTES:</b></p> <ol style="list-style-type: none"> <li>1. Light poles are not allowed within this distance without waiver.</li> <li>2. Implement operational controls to ensure that aircraft larger than the design aircraft do not use the apron without wing-walkers. Publish this information in the airfield operating instruction.</li> </ol>

**Table 6-1. Fixed-Wing Aprons**

Item		Class A Runway	Class B Runway	Remarks
No.	Description	Requirement		
				3. Submit a revised summary of airfield restrictions to allow update to the AMC Airfield Suitability and Restrictions Report. Mail the revision to: HQ AMC/A3AS 402 Scott Drive Unit 3A1 Scott AFB IL 62225-5302
16	Grades in cleared area beyond shoulders to fixed or mobile obstacles	(a) 40 mm (1.5 in) drop-off at edge of paved shoulder, +/- 13 mm (0.5 in). (b) Min 2% Max 10% .	Min 2% Max 10.0%	40 mm (1.5-in) drop-off (+/- 13 mm (0.5 in)) at edge of pavement when the entire shoulder is paved.  When a slope reversal is required within this area, a flat bottom ditch that is graded to drain adequately shall be provided.

**NOTES:**

1. Air Force wingtip clearances may be reduced to those allowed by AFI 11-218 with a waiver. A waiver will be granted only if no other viable options exist.
2. Metric units apply to new airfield construction and, where practical, to modifications to existing airfields and heliports, as discussed in paragraph 1-3.4.
3. The criteria in this manual are based on aircraft specific requirements and are not direct conversions from inch-pound (English) dimensions. Inch-pound units are included only as a reference to the previous standard.
4. Airfield and heliport imaginary surfaces and safe wingtip clearance dimensions are shown as a direct conversion from inch-pound to SI units.
5. For apron edges where fire hydrants must be installed, widen paved shoulders to within 3 m (10 ft) of the hydrants to allow paved access for firefighting vehicles.
6. N/A = not applicable

## **6-6 TAXIING CHARACTERISTICS ON APRONS FOR FIXED-WING AIRCRAFT.**

### **6-6.1 Apron Taxilanes.**

Taxi routes across parking aprons, referred to as taxilanes, are marked on the apron for safe passage of the aircraft. Typical taxilane locations are illustrated in Figures 6-1, 6-2 and 6-3. Minimum wingtip clearances between parked and taxiing aircraft are shown in Table 6-1 (see Figure 6-2). AFI 11-218 provides authorization for operating aircraft at reduced clearances under certain circumstances. If a decision is made to reduce clearances based on this authorization, a waiver must be obtained in accordance with Appendix B, Section 1. Waivers should be pursued only when all avenues for compliance have been exhausted.

### **6-6.2 Turning Capabilities (Aircraft Turning and Maneuvering Characteristics).**

TSC Report 13-2 (Aircraft Characteristics for Airfield Pavement Design and Evaluation Air Force and Army Aircraft) and TSC Report 13-3 (Aircraft Characteristics for Airfield Pavement Design and Evaluation Selective Commercial Aircraft) provide sources for obtaining various turning diagrams for US Army, Air Force, and numerous civil and commercial fixed-wing aircraft.

### **6-6.3 Departure Sequencing.**

Egress patterns from aircraft parking positions to taxiways should be established to prevent congestion at the apron exits. For parking apron access taxiway requirements, see Chapter 5, section 5-10.

### **6-6.4 Minimum Standoff Distances from Edge Pavements.**

See Appendix B, Section 7, for information on minimum standoff distances from edge pavements.

## **6-7 PARKING APRON FOR ROTARY-WING AIRCRAFT.**

Mass parking of rotary-wing aircraft will require an apron designated for rotary-wing aircraft. Parking for transient rotary-wing aircraft and at aviation facilities where only a few rotary-wing aircraft are assigned, may be located on aprons for fixed-wing aircraft. At aviation facilities with assigned rotary-wing aircraft, a transport apron for fixed-wing aircraft is desirable.

### **6-7.1 Location.**

Parking aprons for rotary-wing aircraft should be located similar to parking aprons for fixed-wing aircraft. Rotary-wing aprons must not be located within the lateral clearance distances discussed in Chapters 3 and 4 of this UFC. Generally, company and/or squadron units should be parked together in rows for organizational integrity in locations adjacent to their assigned hangars. Parking aprons for small helicopters (OH, UH, and AH) should be separate from parking areas used by cargo helicopters due to the critical operating characteristics of the larger aircraft.

### **6-7.2 Apron Size.**

As with fixed-wing aircraft aprons, there is no standard size for rotary-wing aircraft aprons. The actual dimensions are based on the number of authorized aircraft, the maneuvering space, and the type of activity that the apron serves.

### **6-7.3 Maneuverability.**

The layout of the rotary-wing parking spacing should allow aircraft access to these locations.

#### **6-7.3.1 Approach.**

Rotary-wing aircraft approach the parking spaces with either a front approach or a sideways (except USN/USMC) approach.

### **6-7.3.2 Undercarriage.**

Rotary-wing aircraft are equipped with either a skid gear or wheel gear. Once on the ground, skid gear-equipped helicopters cannot be easily moved. Wheeled rotary-wing aircraft can be moved after they are on the ground.

### **6-7.4 Army Parking Apron Layout.**

Rotary-wing aircraft are parked in one of two configurations, referred to as Type 1 or Type 2.

#### **6-7.4.1 Type 1.**

In this configuration, rotary-wing aircraft are parked in a single lane, which is perpendicular to the taxilane. In this configuration, the parking arrangement resembles that of fixed-wing aircraft. This parking arrangement is preferred for wheeled aircraft.

##### **6-7.4.1.1 Parking Space, All Aircraft Except CH-47 and CH-53.**

In the Type 1 configuration, the parking space dimensions for all rotary-wing aircraft except the CH-47 and CH-53 is a width of 25 m (80 ft) and a length of 30 m (100 ft). This is illustrated in Figure 6-5.

##### **6-7.4.1.2 Parking Space, CH-47.**

In the Type 1 configuration, the parking space dimensions for the CH-47 rotary-wing aircraft is a width of 30 m (100 ft) and a length of 46 m (150 ft). This is illustrated in Figure 6-6.

##### **6-7.4.1.3 Parking Space, CH-53.**

In the Type 1 configuration, the parking space dimensions for the CH-53 rotary-wing aircraft are a width of 37 m (120') and a length of 50 m (165 ft). This is illustrated in Figure 6-7.

#### **6-7.4.2 Type 2.**

In this configuration, rotary-wing aircraft are parked in a double lane, which is parallel to the taxilane. This parking arrangement is preferred for skid-gear aircraft.

##### **6-7.4.2.1 Parking Space, Skid-Gear Aircraft.**

The parking space dimensions for all skid-gear rotary-wing aircraft in the Type 2 configuration is a width of 25 m (80 ft) and a length of 30 m (100 ft). This is illustrated in Figure 6-9.

#### **6-7.4.2.2 Parking Space, Wheeled.**

The parking space dimensions for all wheeled rotary-wing aircraft in the Type 2 configuration is a width of 30 m (100 ft) and a length of 50 m (160 ft). This is illustrated in Figure 6-10.

#### **6-7.4.3 Barricades and Shelters.**

Where barricades are provided between parking spaces or pull-through shelters are used, include an additional 8 m (26 ft) gap between parking spaces. This is illustrated in Figure 6-8.

#### **6-7.5 Air Force Parking Apron Layout.**

Rotary-wing aircraft at Air Force facilities are parked in a layout similar to that of fixed-wing aircraft. Parking space, taxilane, and clearance dimensions for Air Force facilities will be based on the rotor diameter of the specific aircraft assigned to the facility. For the Air Force, the wingtip clearance criteria provided in AFMAN 32-1084, Table 2.7, is preferred. However, USAF activities may use the Army criteria presented in this UFC for all rotary-wing aircraft except CH-53 and CH-54.

#### **6-7.6 Refueling Considerations.**

As discussed in paragraph 6-5.7, layout of aircraft parking locations and taxilanes should consider aircraft taxiing routes when an aircraft is refueled. There are two primary aircraft fueling systems used:

- Aircraft Direct-Refueling System
- Mobile Aircraft Refuelers

##### **6-7.6.1 Aircraft Direct-Refueling System.**

Aircraft direct fueling stations provide outlets located in the apron where aircraft can be fueled from closed circuit fuel system utilizing multi-arm pantographs or hydrant servicing vehicles (HSV). For design criteria, see UFC 3-460-01. Aircraft direct-refueling systems are designed primarily for "hot" refueling of aircraft.

##### **6-7.6.1.1 Hot Refueling Criteria and Requirements.**

Hot refueling is performed with engines running, it provides minimum aircraft turnaround times and reduces fueling personnel and equipment support requirements. However, it presents hazards not normally encountered during normal fueling operations. Hot refueling is performed while the fuel lines are under pressure. For the Air Force, hot refueling requires the approval of MAJCOM and will not be permitted unless individual aircraft technical order guidance, appropriate checklists and individual fueling systems are available. For additional information, see Air Force T.O. 00-25-172.

##### **6-7.6.2 Mobile Aircraft Refuelers.**

Mobile Aircraft Refuelers are tanker trucks of various capacities and configurations and are used primarily for normal (cold) fueling operations with occasional hot-refueling operations at stations where installation of a direct refueling system is not justified. If continuous or extensive hot fueling is being performed with mobile refuelers, the use of an anchored pantograph should be considered.

### **6-7.6.3 Safety Zone.**

The safety zone for rotary-wing aircraft is the area 3 m (10 ft) greater than the area bounded by the blades and tail of the aircraft as shown on Figure 6-11 and Figure 6-12 for mobile aircraft refuelers and for aircraft direct-refueling system (pit). As shown for direct-refueling systems, the pit should be located outside of the aircraft safety zone, at a minimum, for safe operation. For additional information, see Air Force T.O. 00-25-172 and Navy UFC 2-000-05N.

### **6-7.6.4 Tie-downs and Mooring Points.**

Tie-downs or mooring points are required. See Appendix B, Section 11, for grounding requirements.

### **6-7.7 Parking Dimensions.**

Table 6-2 presents the criteria for rotary-wing apron design for Army airfields. Included in this table are parking space widths, grade requirements, and clearances. Criteria for rotary-wing apron design for the Air Force are presented in AFMAN 32-1084; for the Navy, they are in UFC 2-000-5N .

#### **6-7.7.1 Distances between Parking Spaces.**

The parking space dimensions, discussed in Table 6-2, include separation distances between parked aircraft. When laying out the rotary-wing parking spaces, the spaces should abut next to each other. Separation between rotors and the aircraft bodies is also included in the parking space dimensions.

#### **6-7.7.2 Rotor Blade Clearances.**

The taxilane and hoverlane dimensions in Table 6-2 provide adequate rotor blade clearances for the size of helicopter noted.

Figure 6-5. Type 1 Parking for All Rotary-Wing Aircraft Except CH-47

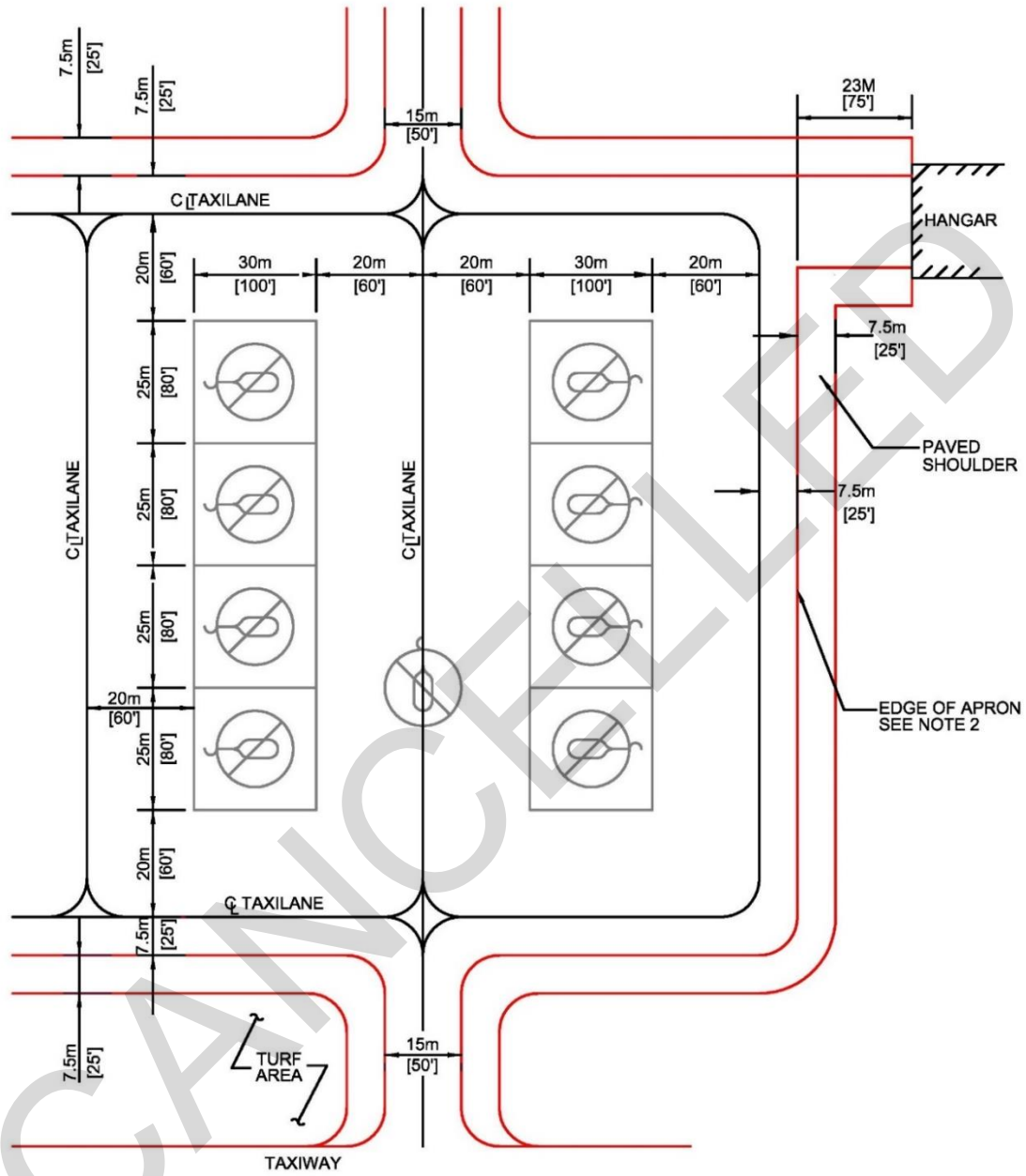

N.T.S.

**NOTES:**

1. THE DASHED LINES FORMING BOXES AROUND THE PARKING POSITIONS SHOW THE LIMITS OF THE SAFETY ZONE AROUND THE PARKED AIRCRAFT. AIRCRAFT ARE TO BE PARKED IN THE CENTER OF THE BOX TO PROVIDE THE PROPER TAXILANE CLEARANCES.
2. EDGE OF APRON IS DEFINED AS EDGE OF A PARKED AIRCRAFT BLOCK OR EDGE OF A PERIMETER TAXIWAY.



Figure 6-6. Type 1 Parking for CH-47

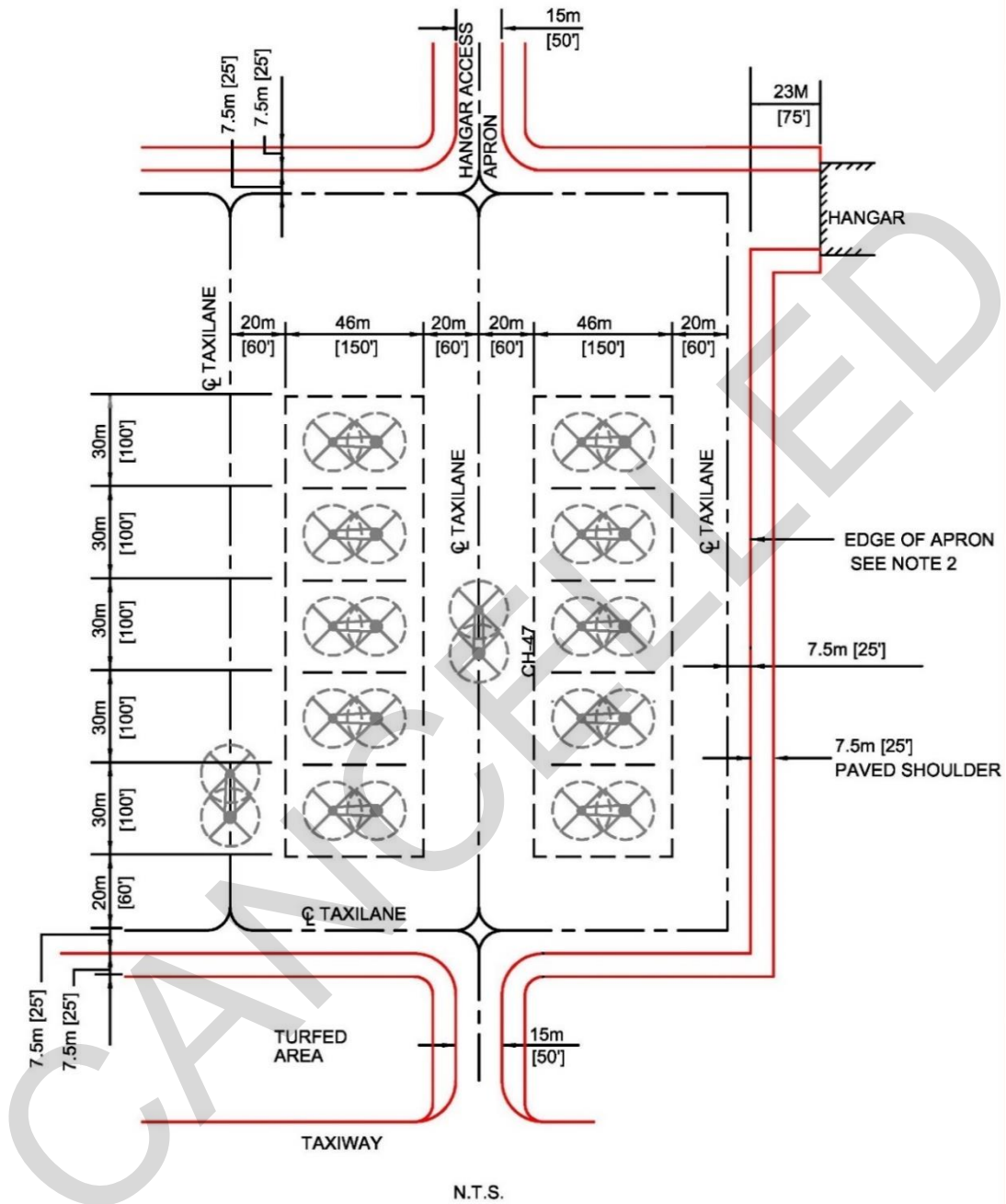

NOTES:

1. THE DASHED LINES FORMING BOXES AROUND THE PARKING POSITIONS SHOW THE LIMITS OF THE SAFETY ZONE AROUND THE PARKED AIRCRAFT. AIRCRAFT ARE TO BE PARKED IN THE CENTER OF THE BOX TO PROVIDE PROPER TAXILANE CLEARANCES.
2. EDGE OF APRON IS DEFINED AS EDGE OF A PARKED AIRCRAFT BLOCK OR EDGE OF A PERIMETER TAXIWAY.

Figure 6-7. Army Type 1 Parking for CH-53

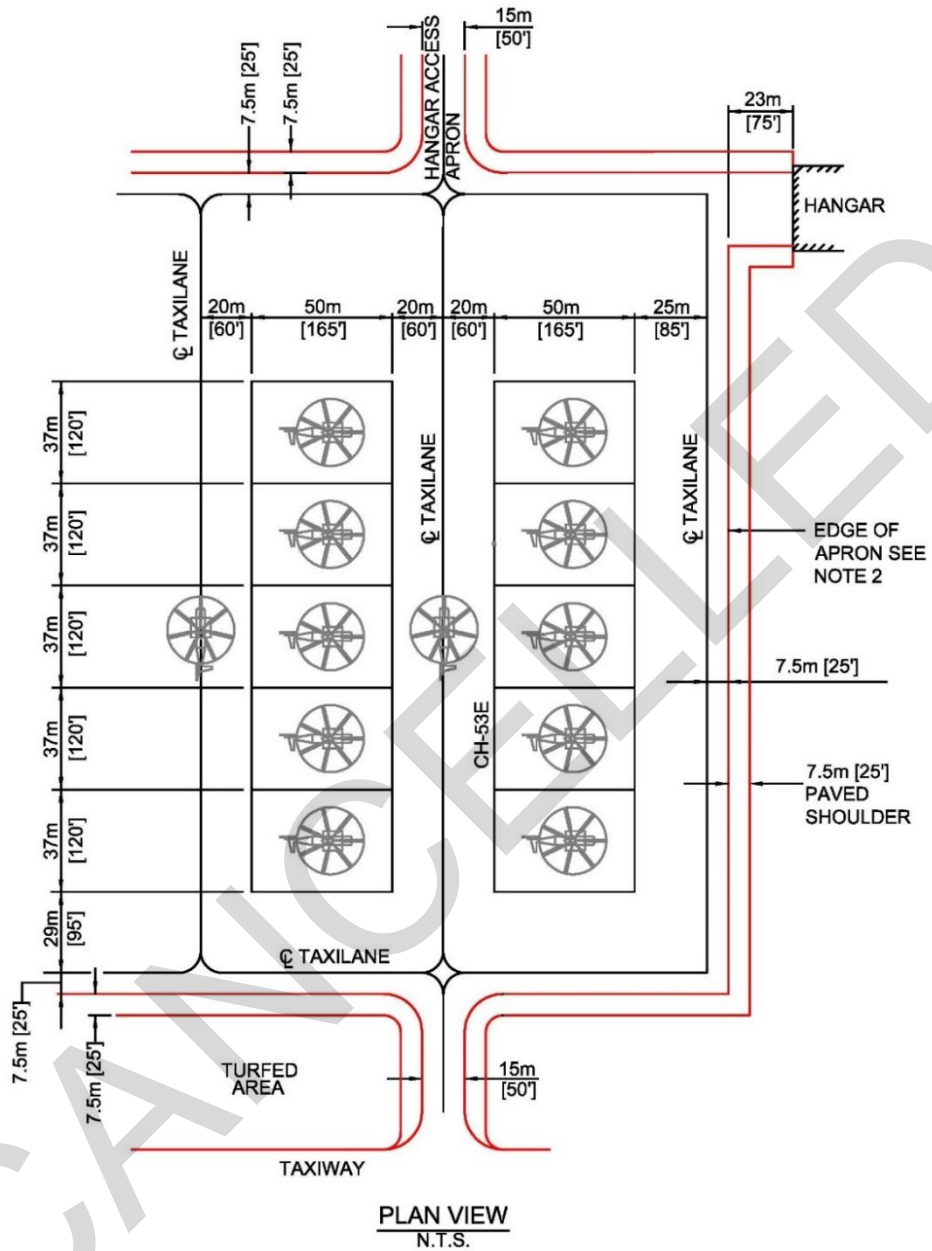

NOTES

1. THE DASHED LINES FORMING BOXES AROUND THE PARKING POSITIONS SHOW THE LIMITS OF THE SAFETY ZONE AROUND THE PARKED AIRCRAFT. AIRCRAFT ARE TO BE PARKED IN THE CENTER OF THE BOX TO PROVIDE PROPER TAXILANE CLEARANCES.
2. EDGE OF APRON IS DEFINED AS EDGE OF A PARKED AIRCRAFT BLOCK OR EDGE OF A PERIMETER TAXIWAY.

Figure 6-8. Army Type 1 Parking for CH-53 with Protective Barriers or Shelters

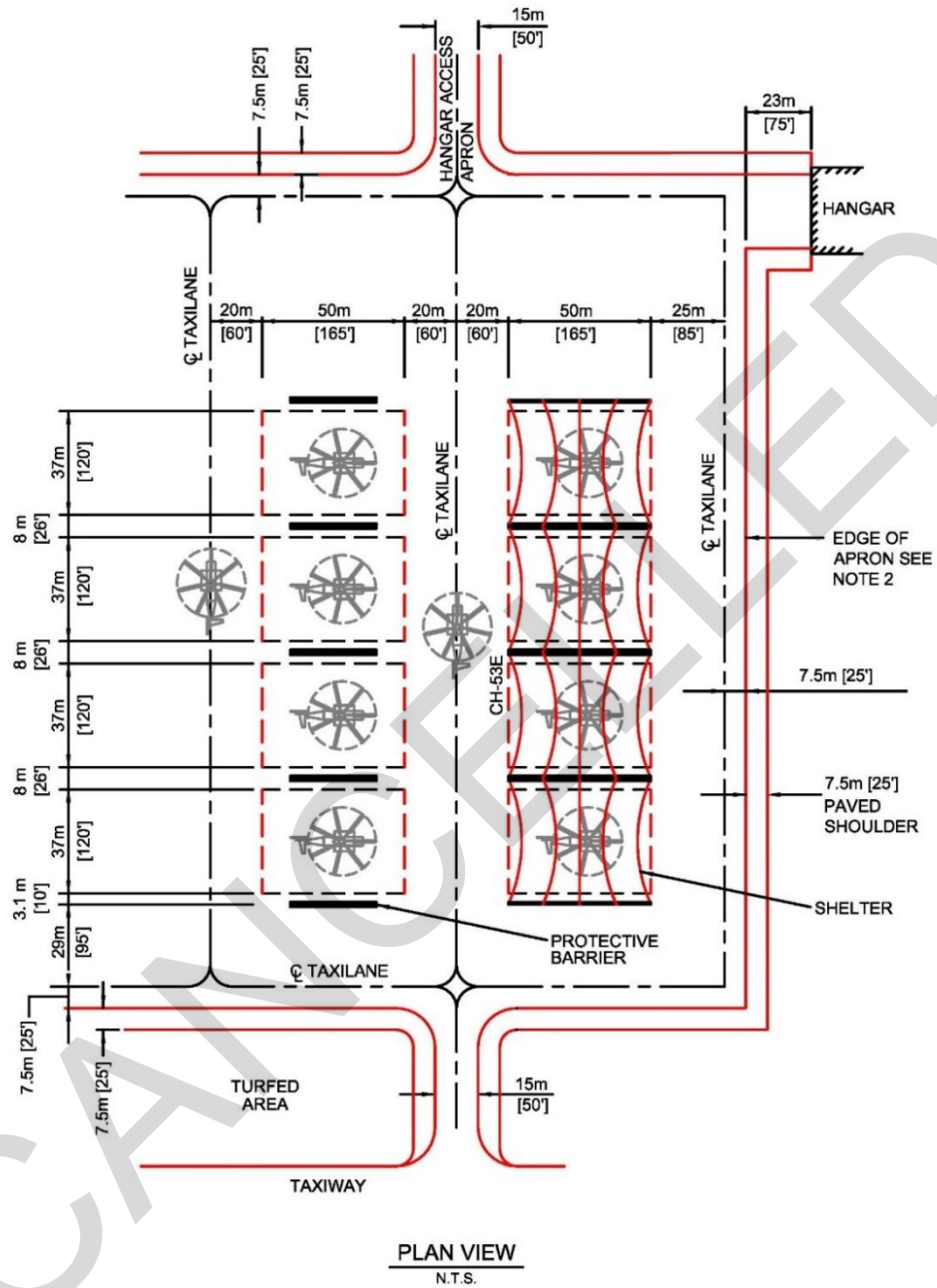

NOTES

1. THE DASHED LINES FORMING BOXES AROUND THE PARKING POSITIONS SHOW THE LIMITS OF THE SAFETY ZONE AROUND THE PARKED AIRCRAFT. AIRCRAFT ARE TO BE PARKED IN THE CENTER OF THE BOX TO PROVIDE PROPER TAXILANE CLEARANCES.
2. EDGE OF APRON IS DEFINED AS EDGE OF A PARKED AIRCRAFT BLOCK OR EDGE OF A PERIMETER TAXIWAY.

Figure 6-9. Type 2 Parking for Skid Rotary-Wing Aircraft

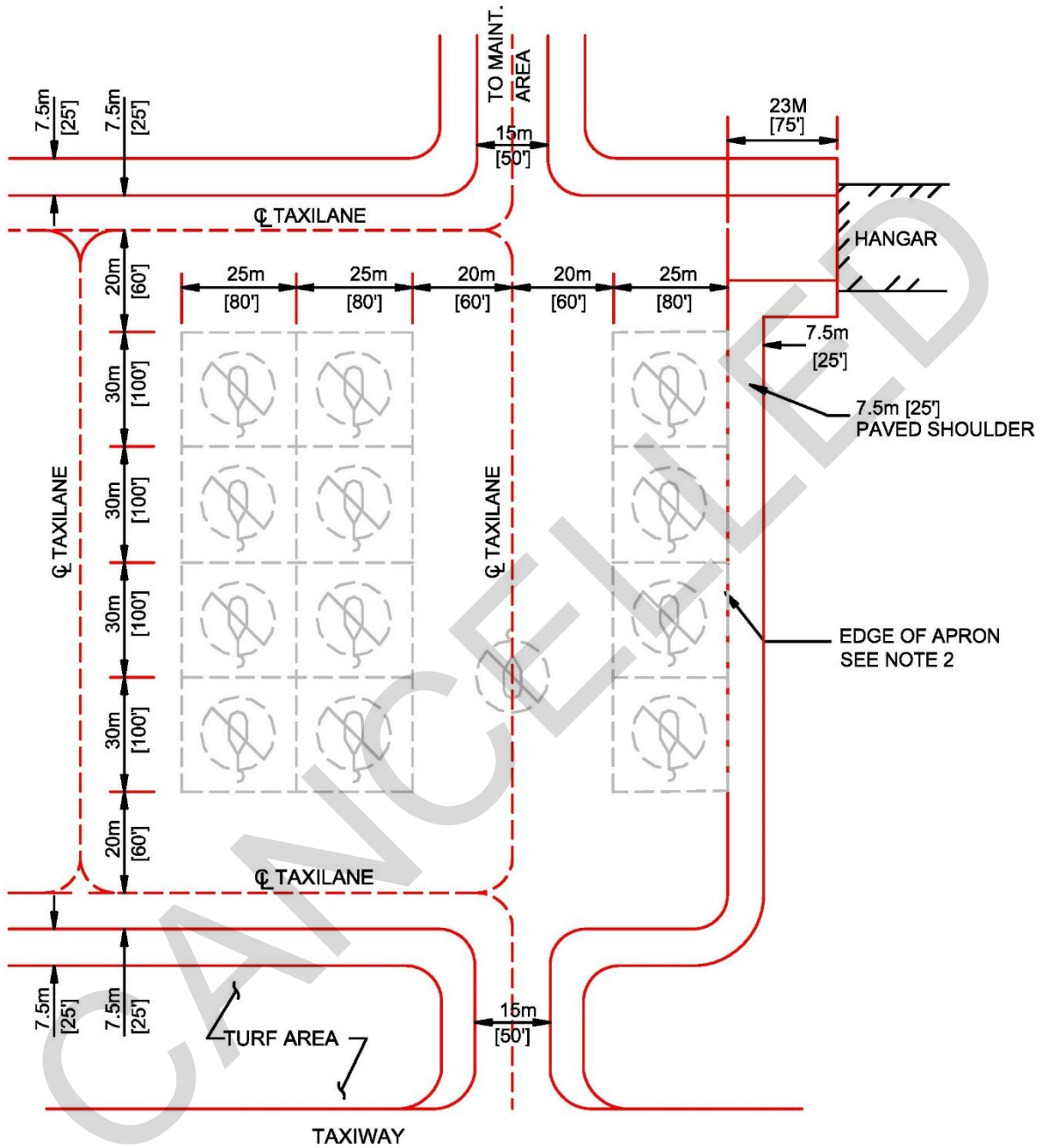

N.T.S.

NOTES

1. THE DASHED LINES FORMING BOXES AROUND THE PARKING POSITIONS SHOW THE LIMITS OF THE SAFETY ZONE AROUND THE PARKED AIRCRAFT. AIRCRAFT ARE TO BE PARKED IN THE CENTER OF THE BOX TO PROVIDE PROPER TAXILANE CLEARANCES.
2. EDGE OF APRON IS DEFINED AS EDGE OF A PARKED AIRCRAFT BLOCK OR EDGE OF A PERIMETER TAXIWAY.

Figure 6-10. Type 2 Parking for Wheeled Rotary-Wing Aircraft

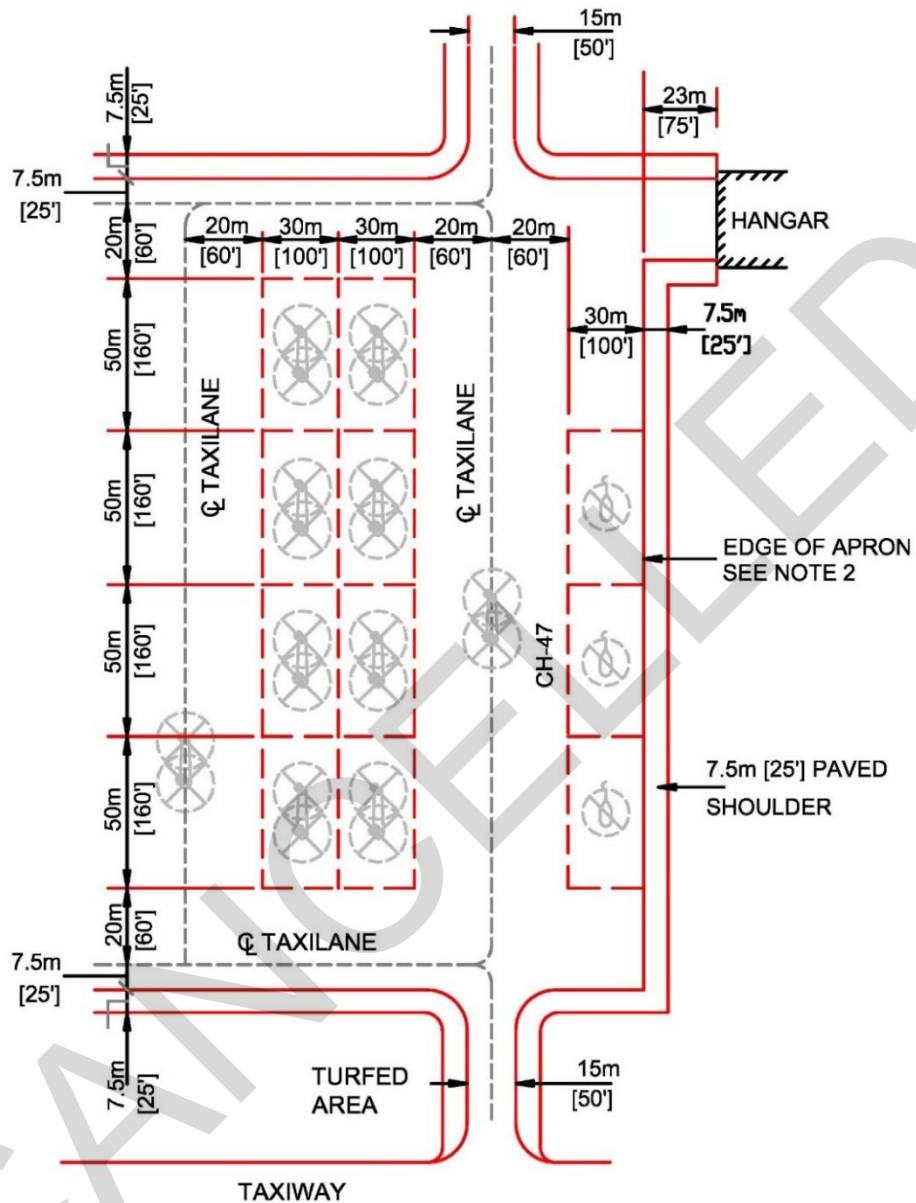

N.T.S.

NOTES

1. THE DASHED LINES FORMING BOXES AROUND THE PARKING POSITIONS SHOW THE LIMITS OF THE SAFETY ZONE AROUND THE PARKED AIRCRAFT. AIRCRAFT ARE TO BE PARKED IN THE CENTER OF THE BOX TO PROVIDE PROPER TAXILANE CLEARANCES.
2. EDGE OF APRON IS DEFINED AS EDGE OF A PARKED AIRCRAFT BLOCK OR EDGE OF A PERIMETER TAXIWAY.
3. PARKING AREAS FOR CH-47 AIRCRAFT AND AH-64/UH-60 SHOULD BE SEPARATED BY A TAXILANE.

Figure 6-11. Refueling Safety Zone Example for Rotary-Wing Aircraft for Normal (Cold) Refueling Operations

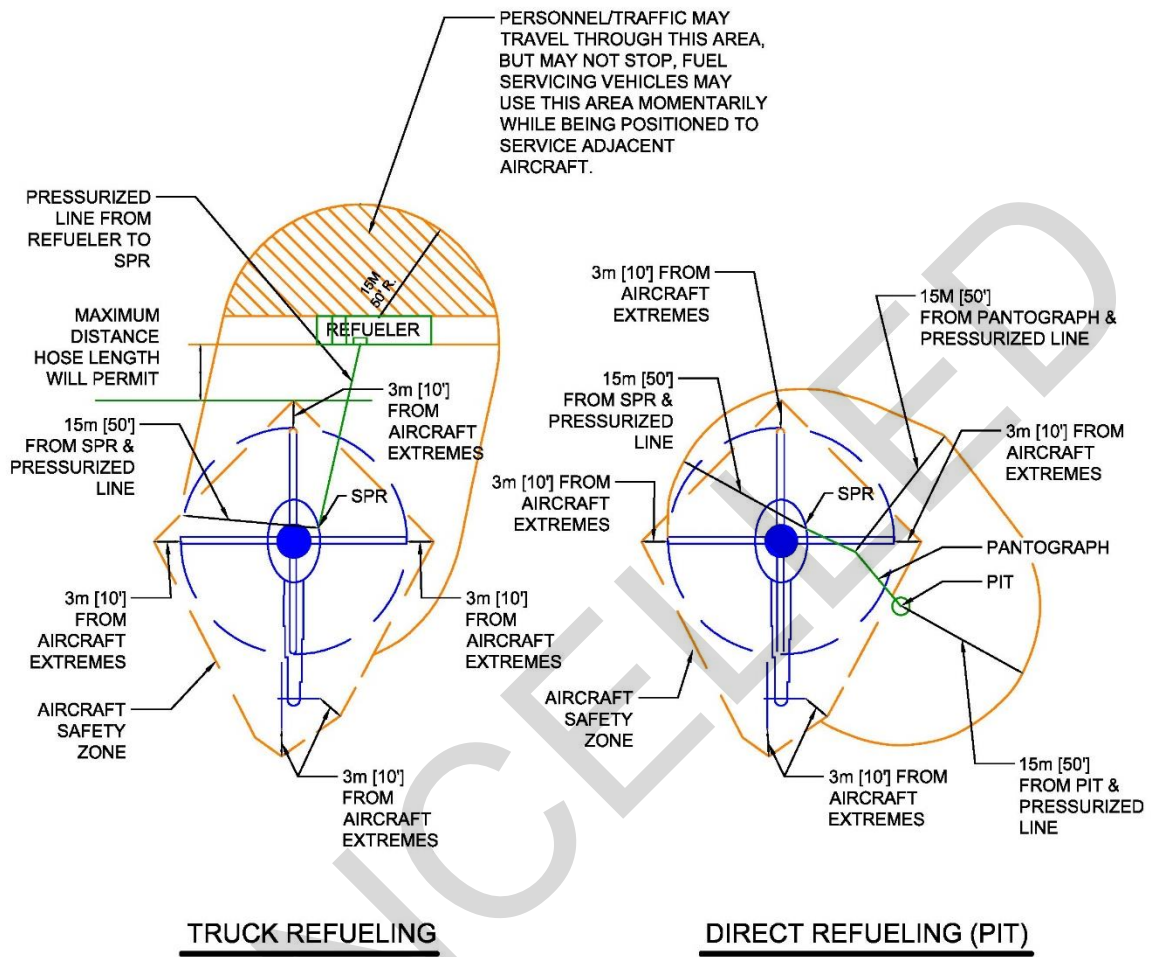

NOTE: CRITERIA SHOWN IS FOR ALL AIRCRAFT NOT SPECIFIC TO AIRCRAFT SHOWN

Figure 6-12. Refueling Safety Zone Example for Rotary-Wing Aircraft for Hot Refueling

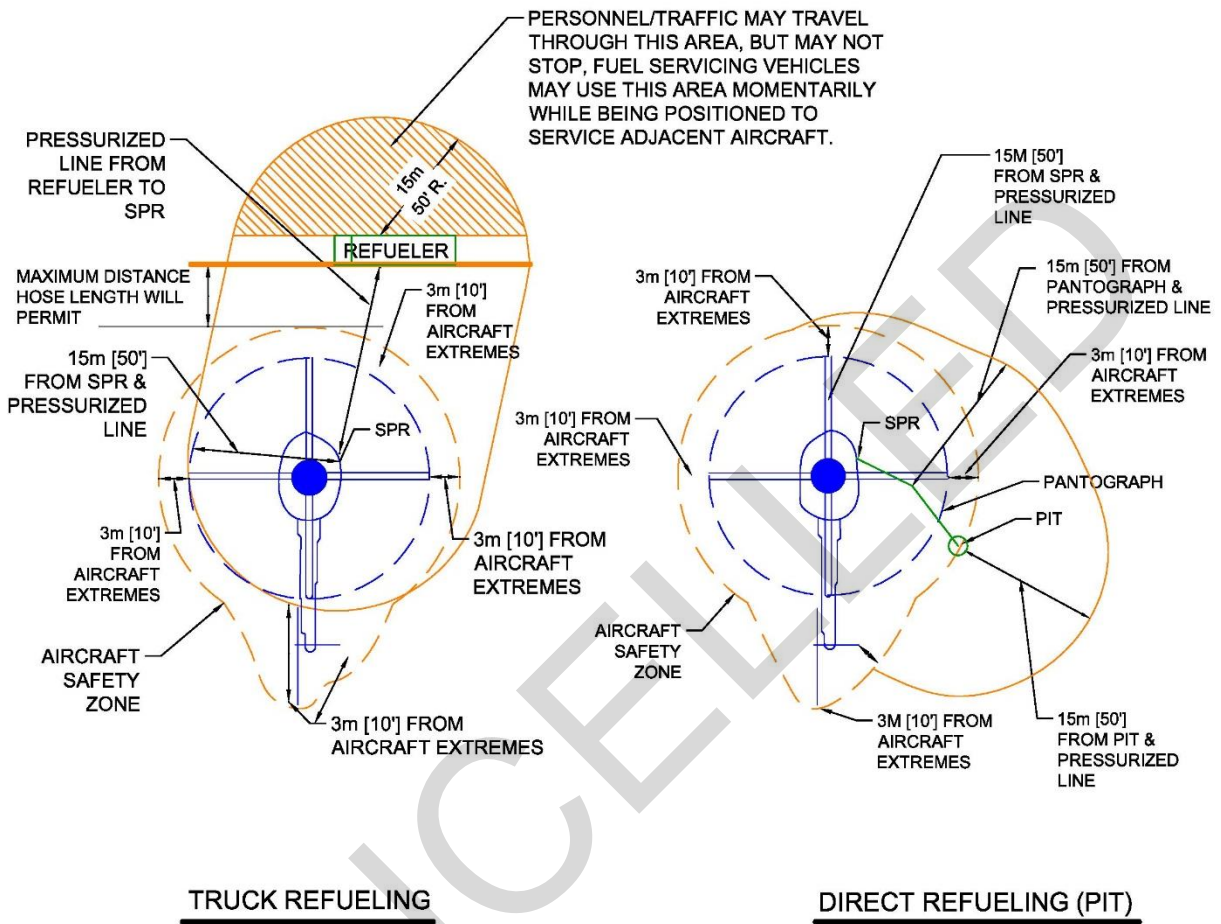

NOTE: CRITERIA SHOWN IS FOR ALL AIRCRAFT. NOT SPECIFIC TO AIRCRAFT SHOWN.

**Table 6-2. Rotary-Wing Aprons for Army Airfields**

Table 6-2. Rotary-Wing Aprons for Army Airfields			
Item		Requirement	Remarks
No.	Description		
1	Size and configuration	Variable For Air Force space requirements, see AFMAN 32-1084. For Navy and Marine Corps space requirements, see UFC 2-000-05N.	Aprons are determined by the types and quantities of helicopters to be accommodated. Other determinants are the physical characteristics of the site and the objective of the master plan.
2	Type 1 parking space width	25 m (80 ft)	Army helicopters not otherwise specified
		30 m (100 ft)	Army CH-47 helicopters
		37 m (120 ft)	Army CH-53 helicopters
			Helicopters parked in single lanes and perpendicular to the taxilane Park helicopter in center of parking space.
3	Type 1 parking space length	30 m (100 ft)	Army helicopters not otherwise specified
		46 m (150 ft)	Army CH-47 helicopters
		50 m (165 ft)	Army CH-53 helicopters
			Helicopters parked in a single lane and perpendicular to the taxilane Park helicopter in center of parking space.
4	Type 2 parking space width	25 m (80 ft)	Army helicopters, skid configuration
		30 m (100 ft)	Army helicopters, wheeled configuration
			Helicopter parked in double lanes and parallel to the taxilane Park helicopter in center of parking space.
5	Type 2 parking space length	30 m (100 ft)	Army helicopters with skid configuration
		50 m (160 ft)	Army helicopters with wheeled configuration



Table 6-2. Rotary-Wing Aprons for Army Airfields

Item		Requirement	Remarks
No.	Description		
			Helicopter parked in double lanes and parallel to the taxilane Park helicopter in center of parking space.
6	Distance between the edge of the parking space and the taxilane centerline	20 m (60 ft)	All Army helicopters
7	Grades in the direction of drainage	Min 0.5% Max 1.5%	Engineering analysis occasionally may indicate a need to vary these limits; however, arbitrary deviation is not intended. Avoid surface drainage with numerous or abrupt grade changes that can cause adverse flexing in the rotor blades.
8	Interior taxilane/hoverlane width (between rows of aircraft)	40 m (120 ft)	From edge of parking space to edge of parking space
9	Peripheral taxilane/hoverlane width	26 m (85 ft)	From edge of parking space to edge of apron
10	Distance between the peripheral taxilane centerline and the edge of apron	7.5 m (25 ft)	From taxilane centerline to edge of apron
11	Clear distance around refueling aircraft	3 m (10 ft)	Outside of an area formed by lines connecting the tips of the blades and tail
12	Shoulders		See Table 5-3.
13	Clearance from the edge of the apron to fixed and mobile obstacles (clear area)	23 m (75 ft)	Measured from rear and side of apron. Distance to other aircraft operational pavements may require a greater clearance except as noted in Appendix B, Section 13.
		30m (100 ft)	For aprons regularly servicing H-53 helicopters
		23 m (75 ft)	When aircraft are towed on and off washracks the rotor clearance can be reduced to 25'.

**NOTES:**

1. Metric units apply to new airfield construction and, where practical, modification to existing airfields and heliports, as discussed in paragraph 1-3.4.
2. The criteria in this manual are based on aircraft specific requirements and are not direct conversions from inch-pound (English) dimensions. Inch-pound units are included only as a reference to the previous standard.
3. Airfield and heliport imaginary surfaces and safe wingtip clearance dimensions are shown as a direct conversion from inch-pound to SI units.

## **6-8 WARM-UP PADS.**

A warm-up pad, also referred to as a holding apron, is a paved area adjacent to a taxiway at or near the end of a runway. The intent of a warm-up pad is to provide a holding location, off the taxiway, for aircraft that must hold due to indeterminate delays. A warm-up pad allows other departing aircraft unencumbered access to the runway. Pads must be sized to provide a minimum of 7.62 m (25 ft) of blast-resistant pavement behind the tail of an aircraft to prevent damage from jet blast.

### **6-8.1 Navy and Marine Corps.**

Warm-up pads are not usually required at Navy facilities. Typically, the end crossover taxiway is widened to 46 m (150 ft), which provides room to accommodate aircraft warming up or waiting for other reasons.

### **6-8.2 Location.**

#### **6-8.2.1 At End Turnoff Taxiway.**

The most advantageous position for a warm-up pad is adjacent to the end turnoff taxiway, between the runway and parallel taxiway, as shown in Figure 6-13; however, other design considerations such as NAVAIDS may make this location undesirable. Do not site new warm-up pads, other aprons, hot cargo spots, or taxiways to these facilities in a way that will allow penetration of the approach-departure clearance surface.

#### **6-8.2.2 Along Parallel Taxiway.**

If airspace and NAVAIDS prevent locating the warm-up pad adjacent to the end turnoff taxiway, the warm-up pad should be located at the end of and adjacent to the parallel taxiway, as shown in Figure 6-14.

### **6-8.3 Siting Considerations.**

#### **6-8.3.1 End of Runway.**

Locate a warm-up pad as close to the runway as possible.

#### **6-8.3.2 Approach-Departure Clearance Surface.**

As discussed in Chapter 3, an obstruction to air navigation occurs when the imaginary surfaces are penetrated. Do not site new warm-up pads, other aprons, hot cargo spots, or taxiways to these facilities in a way that will allow penetration of the approach-departure clearance surface. Such aircraft penetrations may require revisions to TERPS procedures. Properly sited warm-up positions are illustrated in Figures 6-15 and 6-16.

#### **6-8.3.3 Navigational Aids (NAVAIDS).**

Warm-up pads must be located so that they do not interfere with the operation of NAVAIDS, including instrument landing system (ILS) equipment and precision approach radar (PAR) facilities. To eliminate interference of the ILS signal by holding aircraft, holding aircraft on or off a warm-up pad must be outside the critical areas. The critical area for ILS equipment is illustrated in Figures 6-17, 6-18, and 6-19. Additional discussion of ILS critical areas is provided in TM 5-823-4, AFI 13-203, and UFC 3-260-04.

#### **6-8.4 Warm-Up Pad Size.**

The size of the warm-up pad will be such to allow accommodating two of the largest aircraft assigned to the facility simultaneously, wingtip clearances required by the clear distance information presented in Table 6-1, and to provide a minimum of 7.62 m (25 ft) of blast-resistant pavement behind the tail of an aircraft to prevent damage from jet blast.

#### **6-8.5 Taxi-In/Taxi-Out Capabilities.**

The parking locations will have taxi-in/taxi-out capabilities to allow aircraft to taxi to their warm-up position under their own power as shown in Figure 6-20.

Figure 6-13. Warm-Up Pad at End of Parallel Taxiway

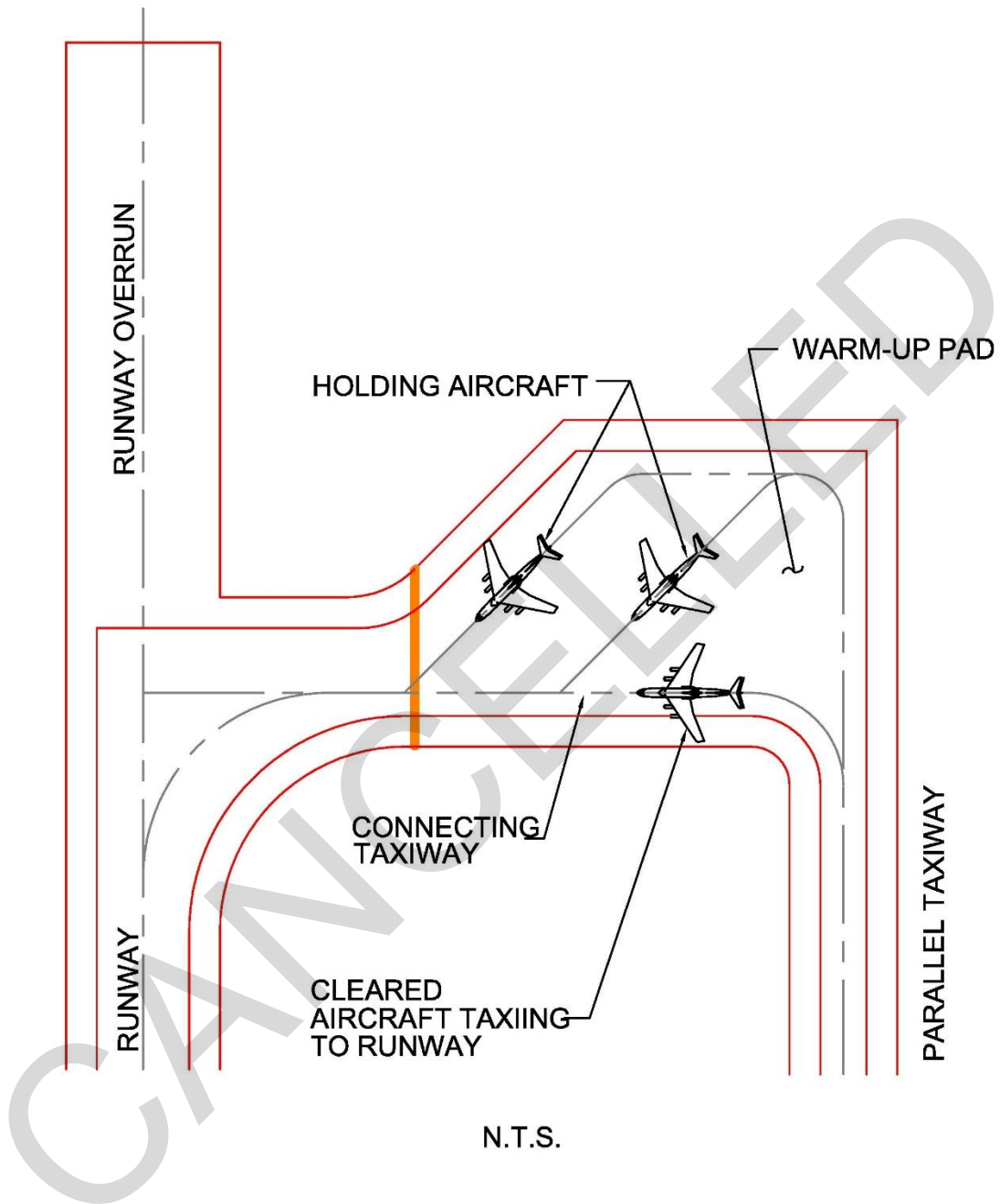
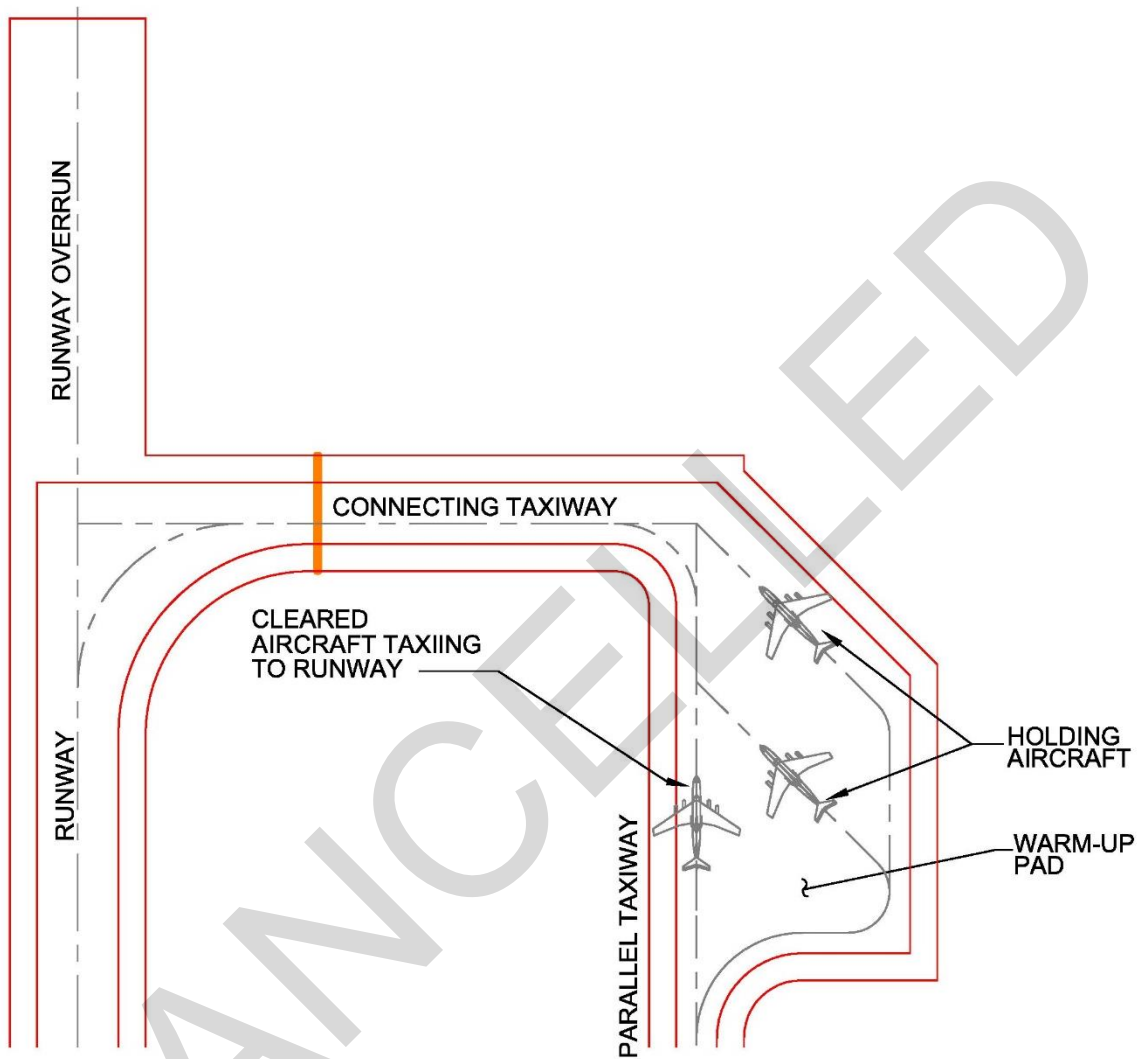

Figure 6-14. Warm-Up Pad Next to Parallel Taxiway



N.T.S.

Figure 6-15. Warm-Up Pad Located in Clear Zone

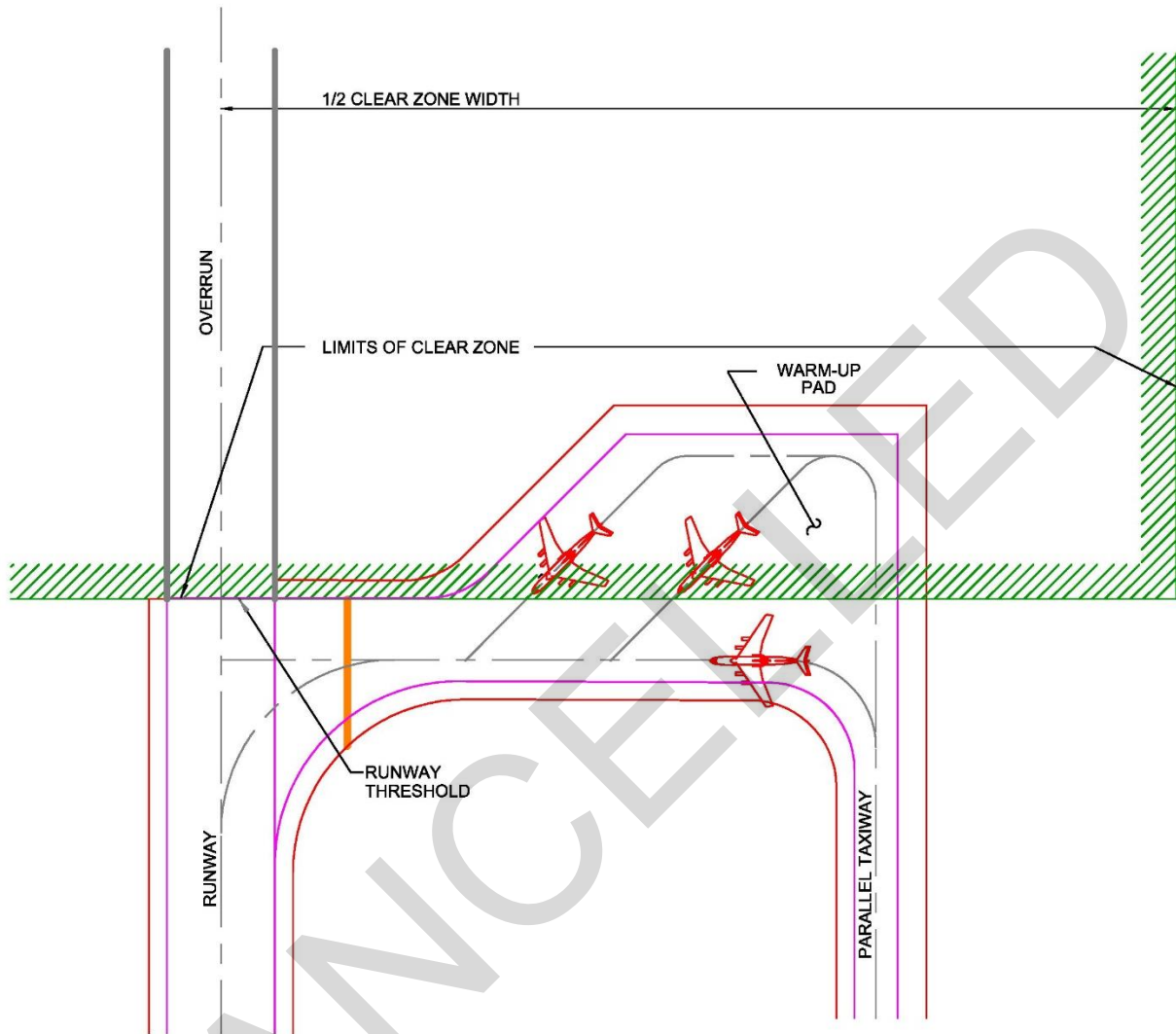
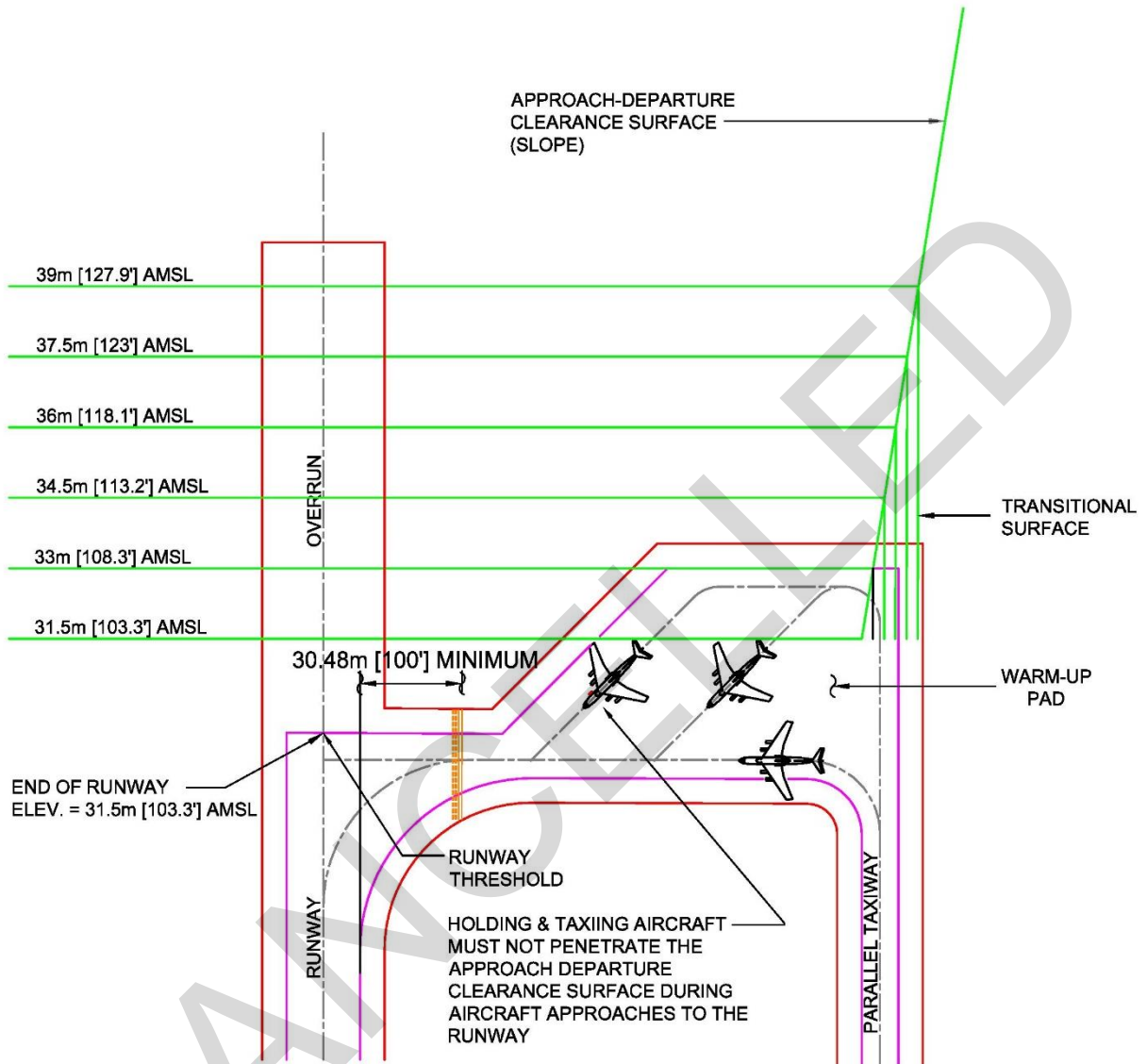
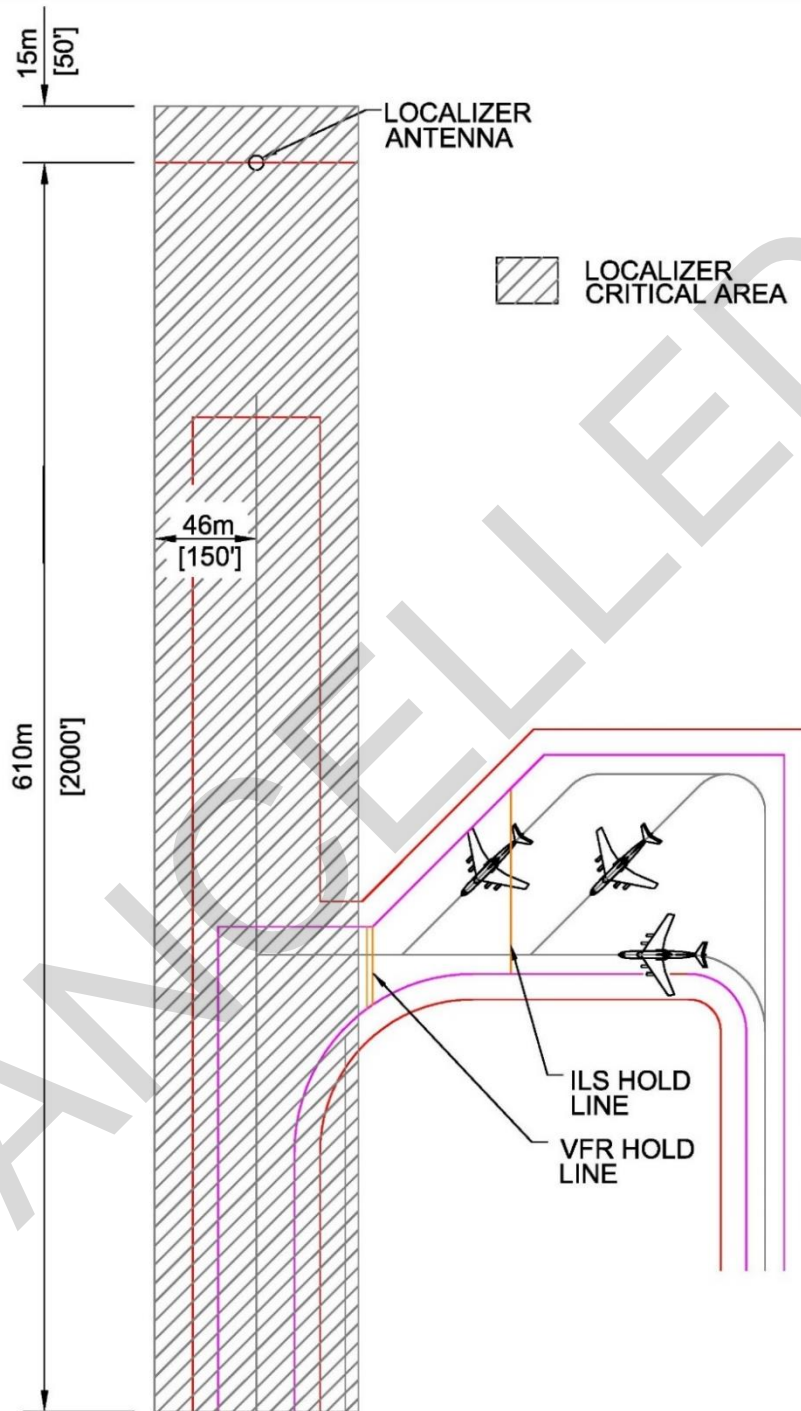

Figure 6-16. Warm-Up Pad Located in Approach-Departure Clearance Surface



N.T.S.

Figure 6-17. Warm-Up Pad/Localizer Critical Area



N.T.S.



Figure 6-18. Warm-Up Pad/Glide Slope Critical Area

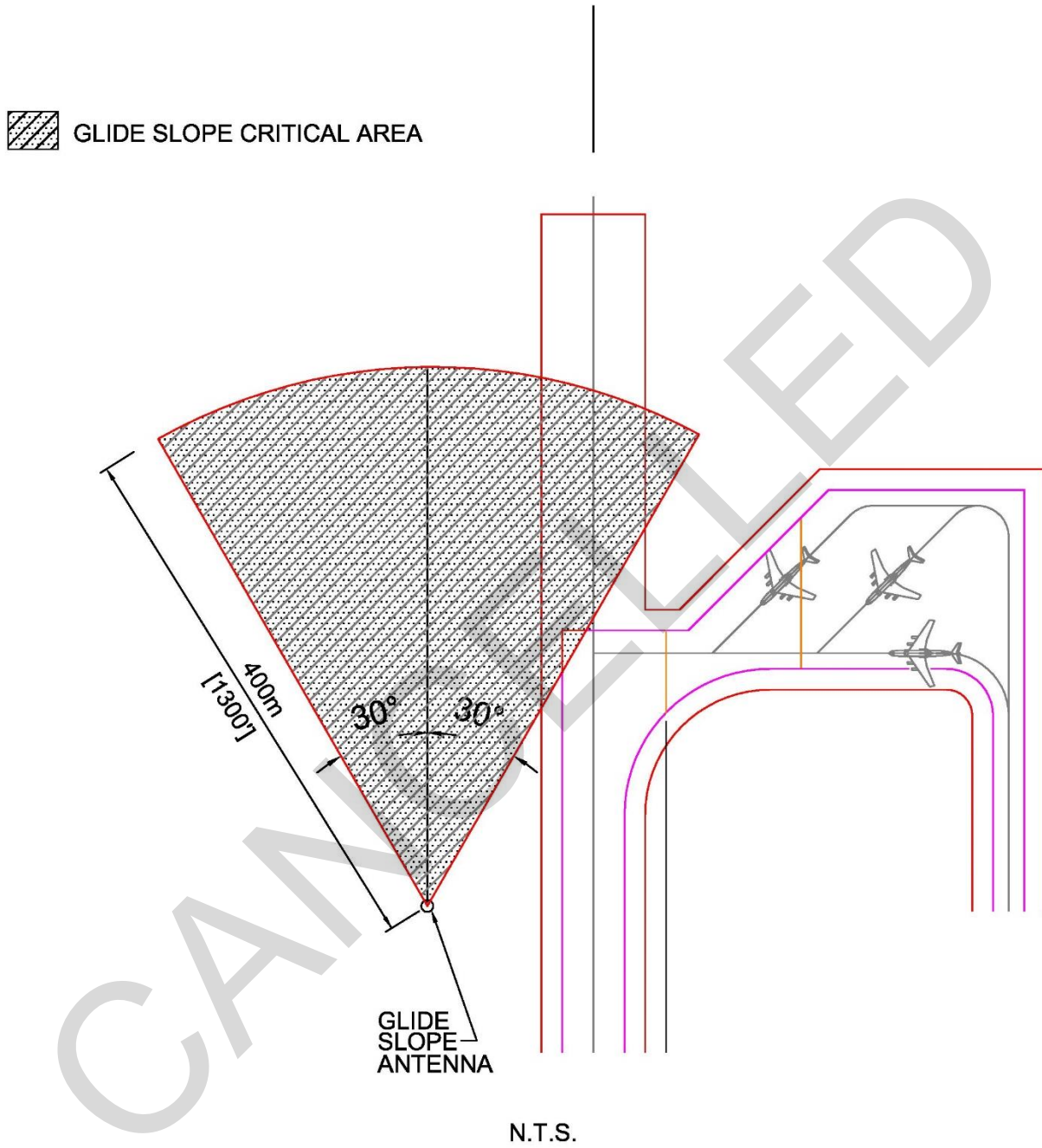
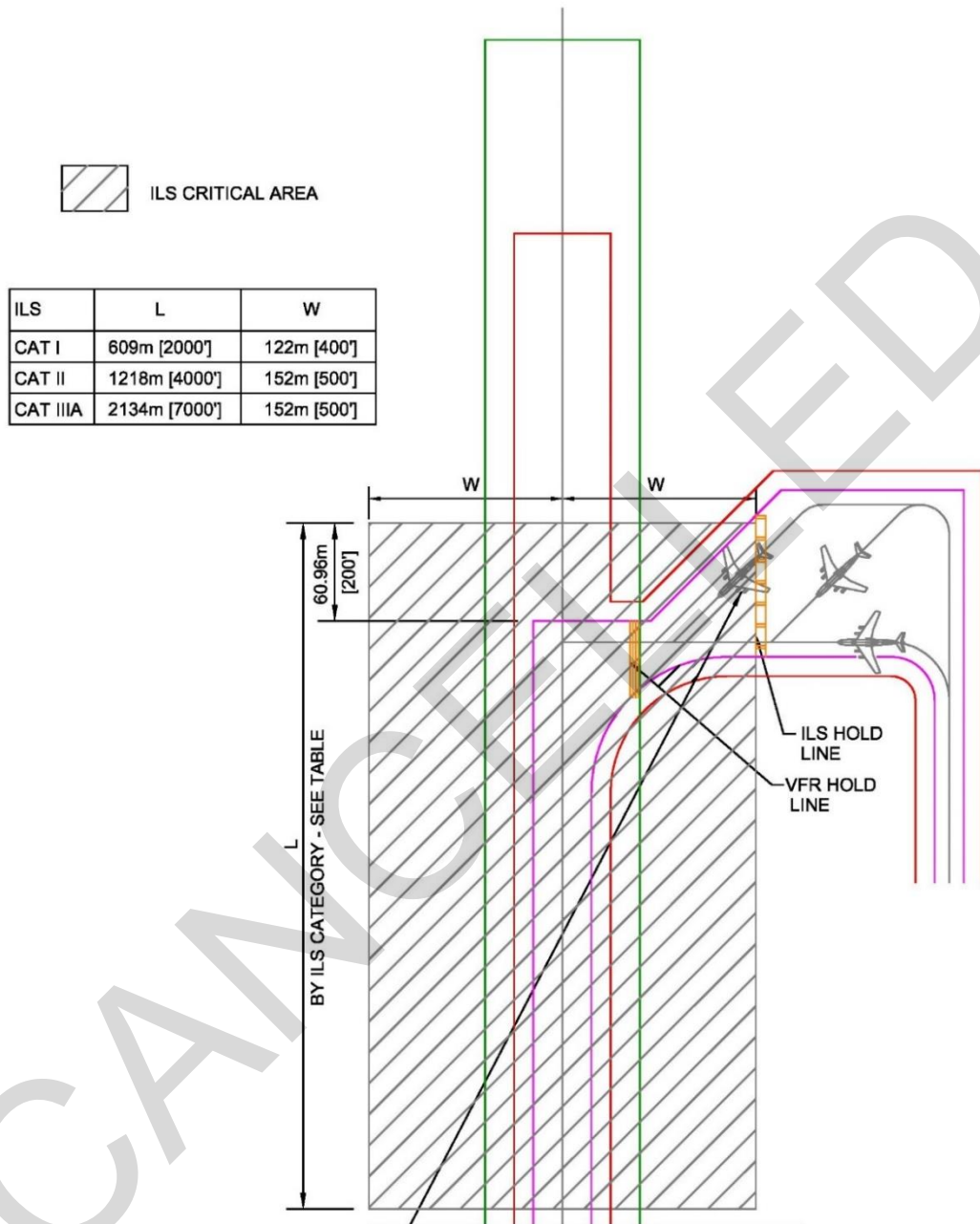

Figure 6-19. Warm-Up Pad/CAT II ILS Critical Area



**NOTES**

1. THIS HOLDING SPOT CANNOT BE USED DURING IFR CONDITIONS. AIRCRAFT IN THIS PARTICULAR POSITION ARE WITHIN THE LOCALIZER CRITICAL AREA IDENTIFIED BY THE ILS HOLD LINE. UNDER INSTRUMENT FLIGHT CONDITIONS THIS AREA SHOULD BE CLEAR OF OBJECTS THAT COULD REFLECT OR BLOCK THE ILS SIGNAL.
2. SITING OF WARM-UP PAD BASED ON CAT 1 CRITERIA MAY LIMIT FUTURE USE OF FIRST HOLD POSITION IF HIGHER CATEGORY APPROACHES ARE INSTALLED.

Figure 6-20. Warm-Up Pad Taxiing and Wingtip Clearance Requirements

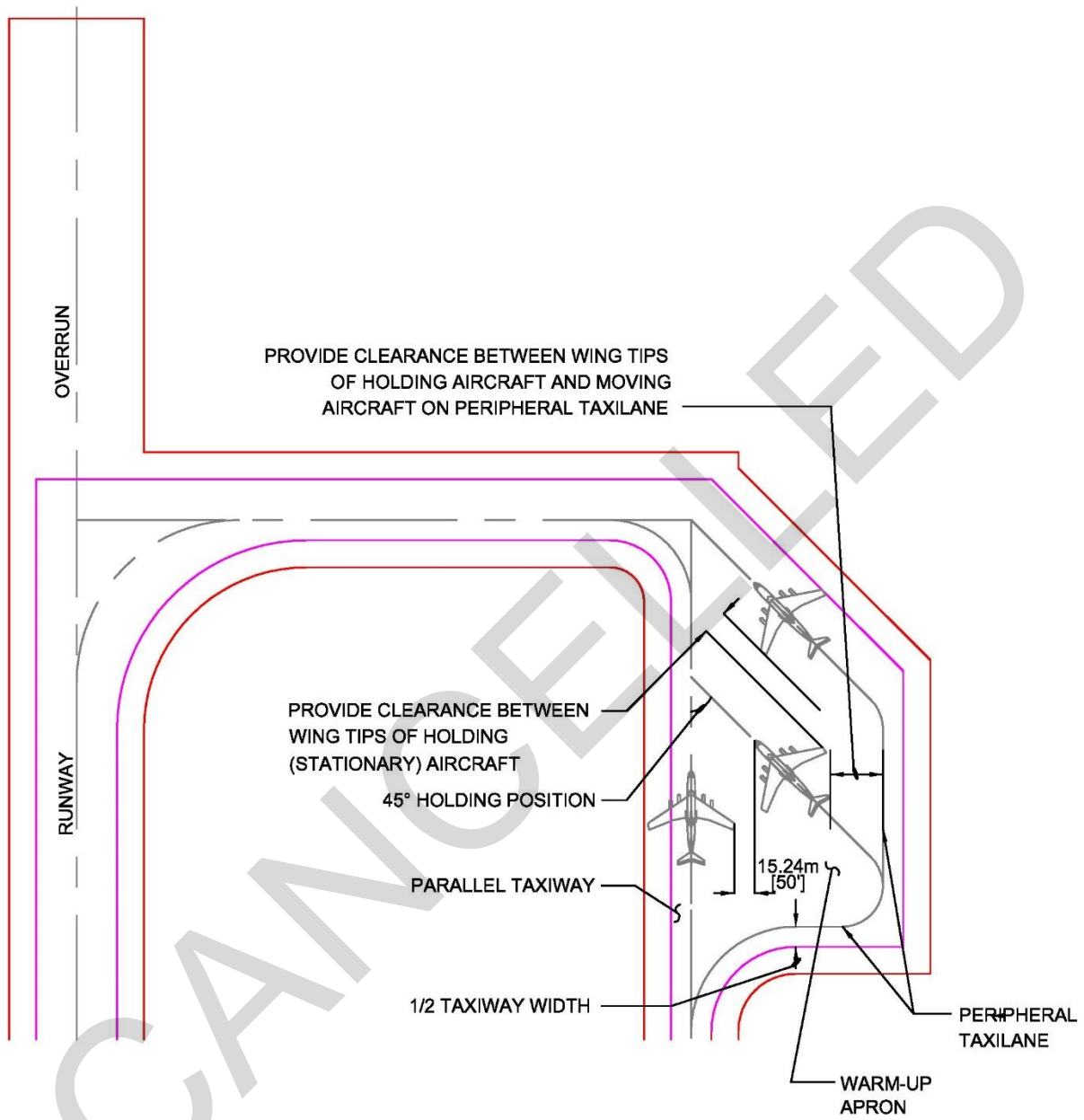

N.T.S.

### **6-8.6 Parking Angle.**

Aircraft should be parked at a 45-degree angle to the parallel taxiway to divert the effects of jet blast away from the parallel taxiway. (See Appendix B, Section 7, for minimum standoff distances.) This is shown in Figure 6-20.

### **6-8.7 Turning Radius.**

The turning radius on warm-up pads will be designed to provide the minimum allowable turn under power for the largest aircraft assigned to the base.

### **6-8.8 Taxilanes on Warm-Up Pads.**

Taxilanes on the warm-up pad will meet the lateral clearance requirements discussed in Table 6-1. Lateral and wingtip clearance for a taxilane on a warm-up pad is illustrated in Figure 6-20.

### **6-8.9 Tie-Downs and Grounding Points.**

Tie-downs, mooring points, and grounding points are not required on warm-up pads.

## **6-9 POWER CHECK PAD.**

An aircraft power check pad is a paved area, with an anchor block in the center, used to perform full-power engine diagnostic testing of aircraft engines while the aircraft is held stationary.

### **6-9.1 Location and Siting Considerations.**

Unsuppressed power check pads should be located near maintenance hangars, but at a location where full-power engine diagnostic testing of jet engines can be performed with minimal noise exposure to inhabited areas on and off the base.

### **6-9.2 Unsuppressed Power Check Pad Layout.**

Power check pads may be rectangular, square, or circular.

#### **6-9.2.1 Army and Air Force.**

Power check pad layouts for Army and Air Force aviation facilities are shown in Figures 6-21, 6-22, and 6-23.

#### **6-9.2.2 Navy and Marine Corps.**

Power check pad layouts for Navy and Marine Corps aviation facilities are found in UFC 4-212-01N.

### **6-9.3 Access Taxiway/Towway.**

An access taxiway will be provided for access from the primary taxiway to the power check pad. If the aircraft is to be towed to the unsuppressed power check pad, the access pavement should be designed as a towway. Taxiway and towway design requirements are presented in Chapter 5.

#### **6-9.4 Grading.**

The surface of the unsuppressed power check pad must slope 3.5% away from the anchor block in the direction of jet blast to the pavement edge to divert the effect of jet blast away from the concrete surfaces and pavement joints. See Figure 6-24.

#### **6-9.5 Thrust Anchors/Mooring Points.**

Thrust anchors (Air Force) or mooring points (Army) or tie-down mooring eyes (Navy and Marine Corps) are required on unsuppressed power check pads. Layout for these anchors is interdependent of joint spacing, and the two should be coordinated together. Tie-down and grounding points are discussed further in Appendix B, Section 11.

##### **6-9.5.1 Army and Air Force.**

Power check pad thrust anchors designed for 267 kilonewtons (kN) (60,000 lbf) (Army and Air Force aviation facilities) and for 445 kN (100,000 lbf) are provided in Appendix B, Section 15.

##### **6-9.5.2 Navy and Marine Corps.**

Power check pad tie-down mooring eye designed for Navy and Marine Corps aviation facilities are found in UFC 4-212-01N.

Figure 6-21. Geometry for Rectangular Power Check Pad

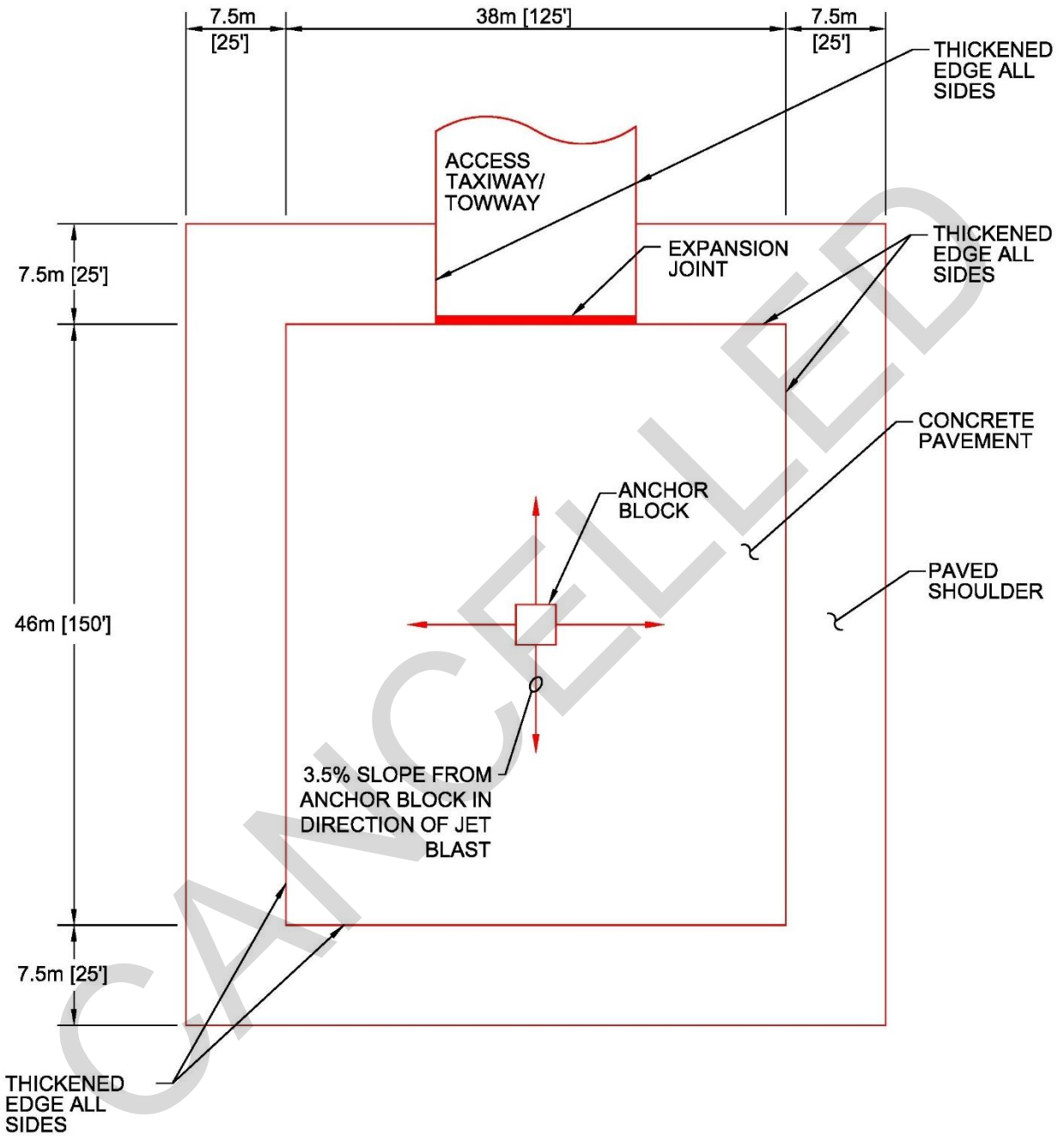

N.T.S.

Figure 6-22. Geometry for Square Power Check Pad

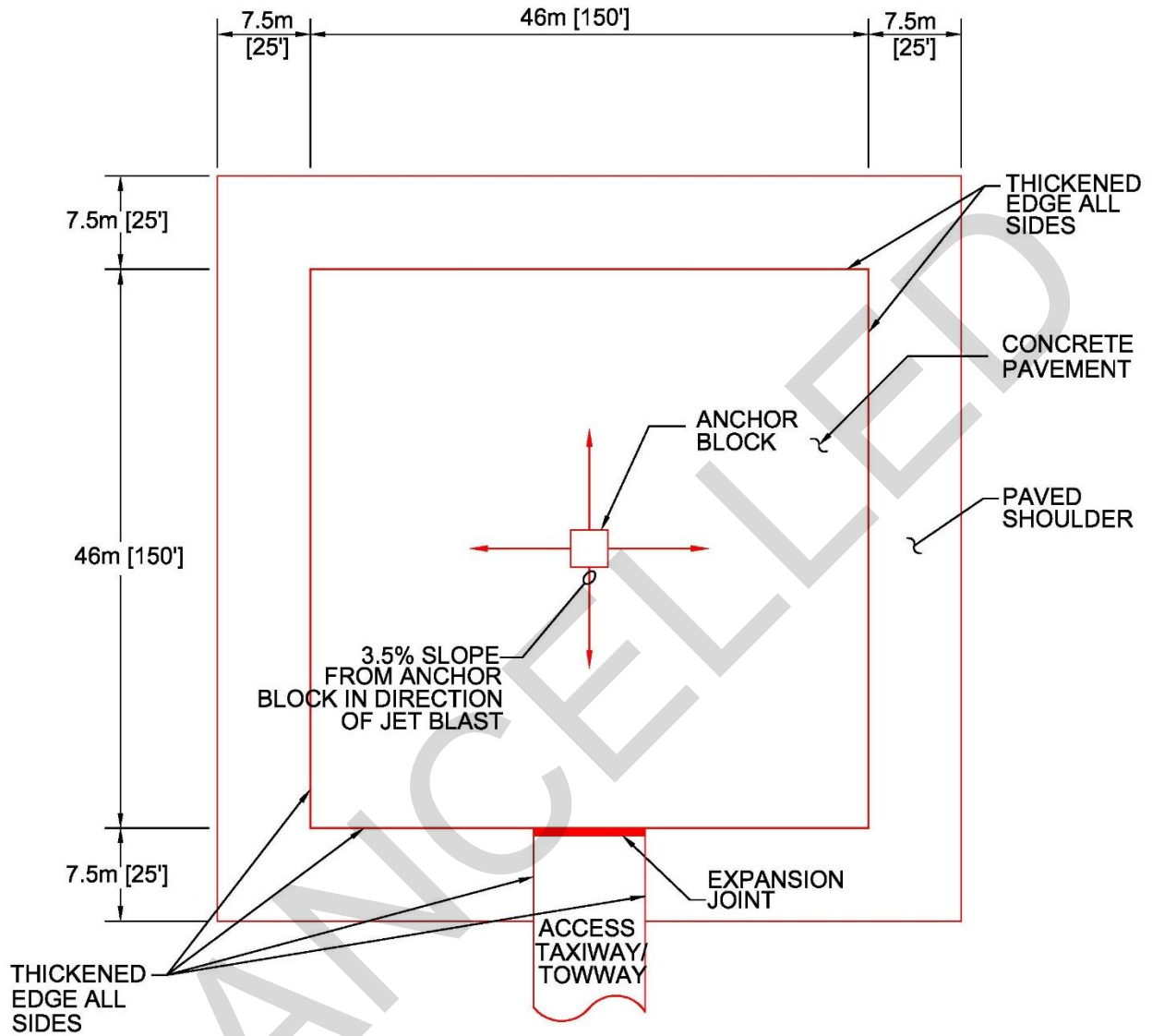

N.T.S.

Figure 6-23. Geometry for Circular Power Check Pad

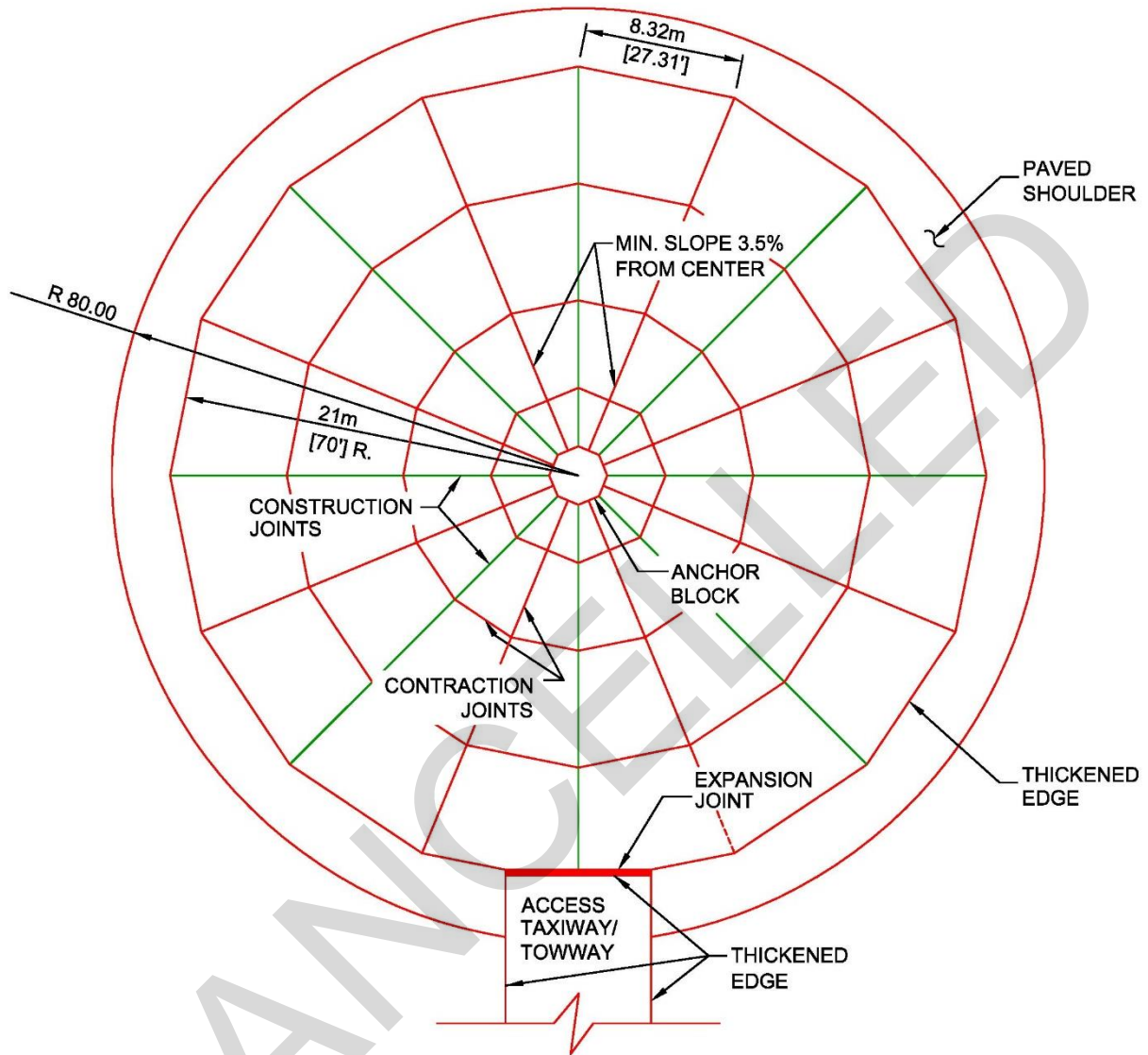

N.T.S.



Figure 6-24. Power Check Pad Grading

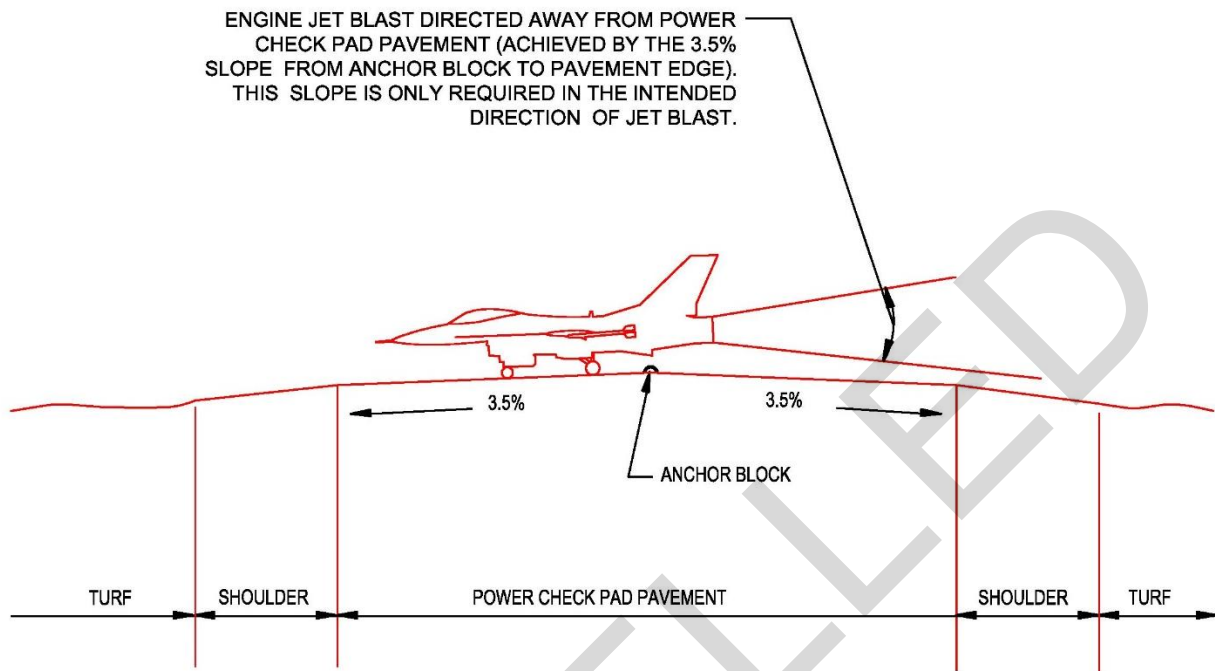

NOTES

1. PROVIDE A 150mm DIAMETER BRASS MONUMENT ANCHORED WITHIN THE THRUST BLOCK THAT INDICATES THE FOLLOWING: "BIDIRECTIONAL THRUST ANCHOR MAXIMUM CAPACITY IS 60,000
2. ON THE MONUMENT, SHOW A BIDIRECTIONAL ARROW INDICATING THE INTENDED DIRECTIONS FOR LOADING.

### 6-9.6 Anchor Blocks.

All unsuppressed power check pads have a thrust anchor block installed in the center of the power check pad to anchor the aircraft during engine testing. Anchor blocks are structurally designed for each individual aircraft. The designer must verify structural adequacy of the anchor block for the mission aircraft and engine type.

#### 6-9.6.1 Army and Air Force.

Thrust anchor blocks for Army and Air Force aviation facilities are provided in Appendix B, Section 15.

#### 6-9.6.2 Navy and Marine Corps.

Thrust anchor blocks for Navy and Marine Corps aviation facilities are provided in UFC 4-212-01N.

## **6-9.7 Power Check Pad Facilities.**

Power check pads for Navy and Marine Corps aviation facilities are provided in UFC 4-212-01N

### **6-9.7.1 Required Facilities.**

The unsuppressed power check pad should consist of these required items:

- Paved surface
- Paved shoulders (see Appendix B, Section 7, for minimum standoff distances)
- A thrust anchor or anchors for aircraft serviced at the pad
- Blast deflectors if required to protect the surrounding area from jet blast damage

### **6-9.7.2 Optional Facilities.**

The unsuppressed power check pad may include these items:

- Floodlighting for night operations
- Water supply to wash down fuel spills
- Oil separators, holding tanks, and fuel treatment to address fuel spillage prior to discharge into sanitary or storm sewer
- Communication link with the maintenance control room
- Fire hydrants
- A paved roadway to the unsuppressed power check pad for access by firefighting, towing, and aircraft maintenance support vehicles

## **6-9.8 Noise Considerations.**

The noise level at unsuppressed power check pads may exceed 115 decibels (dB(a)) during power-up engine tests. Caution signs should be placed around the power check pad indicating both the presence of hazardous noise levels and the need for hearing protection.

## **6-10 ARM/DEARM PADS.**

The arm/dearm pad is used for arming aircraft immediately before takeoff and for dearming (safing) weapons retained or not expended upon their return. Do not site arm/dearm pads, other aprons, hot cargo spots, or taxiways to these facilities in a way that will allow penetration of the approach-departure clearance surface.

### **6-10.1 Navy and Marine Corps Requirements.**

Navy and Marine Corps requirements for arm/dearm pads are provided in UFC 2-000-05N.

## **6-10.2 Location.**

Air Force arm/dearm pads should be located adjacent to runway thresholds and sited such that armed aircraft are oriented in the direction of least populated areas or towards revetments.

## **6-10.3 Siting Considerations.**

### **6-10.3.1 Aircraft Heading.**

The criteria for establishing the exact heading of the parked aircraft depends on the type of aircraft and associated weapons. This information is contained within the classified portion of the aircraft manuals. The most economical means of parking aircraft on the arm/dearm pads is at 45 degrees to the taxiway; however, because of the requirement to orient armed aircraft away from populated areas, this angle may vary.

### **6-10.3.2 Forward Firing Munitions Protection Zone.**

Coordinate with the responsible safety office to determine the specific risks associated with the mission aircraft and establish protection zones or available measures to mitigate risk. It is good practice to keep all buildings out of this protection zone to prevent damage from accidental weapon firing. This forward firing munitions protection zone may cross a runway, taxiway, or runway approach as long as the landing and taxiing aircraft can be seen by the arm/dearm quick check crews and the arming/dearming operations can cease for the period in which the aircraft passes. Parked aircraft or parked vehicles must not be located in the forward firing munitions protection zone. If a protection zone appropriate for the type of munitions to be used cannot be obtained, earth revetments or similar risk mitigation measures (barricades, etc.) should be used, but must be sited properly relative to wingtip and airspace clearance requirements.

### **6-10.3.3 Electromagnetically Quiet Location.**

Prior to construction of any pad, local field measurements must be taken or verified with the installation weapons safety manager to ensure that the location is electromagnetically quiet. To avoid potential electromagnetic interference from taxiing aircraft, pads should be located on the side of a runway opposite the parallel taxiway. Use concrete encased rigid steel conduits for any electrical conductors located within 200 ft of the pad. Navy and Marine Corps aviation facilities must have an electromagnetic compatibility (EMC) background study by SPAWARSYSCEN Charleston, as described in NAVAIR 16-1-529. The Air Force conducts electromagnetic radiation (EMR) surveys with regard to explosives safety in accordance with AFI 91-208. The specific information for each emitting device should be available through the installation communications squadron.

#### **6-10.4 Arm/Dearm Pad Size.**

Each arm/dearm pad should be capable of servicing four or six aircraft at a time. The dimensions of the pad must be based on the length, wingspan, and turning radius of the aircraft to be served. Jet blast must also be taken into account. Typical layouts of arm/dearm pads are shown in Figures 6-25, 6-26, 6-27, and 6-28.

#### **6-10.5 Taxi-In/Taxi-Out Capabilities.**

The parking locations should have taxi-in/taxi-out capabilities to allow aircraft to taxi to their arm/dearm location under their own power.

#### **6-10.6 Parking Angle.**

The parking angle depends on the type of aircraft, type of weapons, and the associated uninhabited clear zone location.

#### **6-10.7 Turning Radius.**

The turning radius for taxilanes on arm/dearm pads should be designed to provide the minimum allowable turn under power of the largest aircraft that will use the arm/dearm pad.

#### **6-10.8 Access Road.**

An all-weather access road should be constructed to the arm/dearm pad from outside the airfield's taxiway and runway clearance areas. Design this road in accordance with UFC 3-250-18FA and UFC 3-250-01FA. Access roads must not encroach on taxiway clearances or taxilane wingtip clearance requirements (except at necessary intersections with these areas), nor shall any parking area associated with the access road be sited so that maintenance vehicles will violate the approach-departure clearance surface or any NAVAID critical area.

#### **6-10.9 Tie-downs and Grounding Points.**

Tie-downs and mooring points are not required on arm/dearm pads. See Appendix B, Section 11, for grounding requirements.

#### **6-10.10 Ammunition and Explosives Safety Standards.**

Ammunition and explosives safety standards are discussed in Appendix B, Section 9.

Figure 6-25. Arm-Dearm Pad for F-15 Fighter

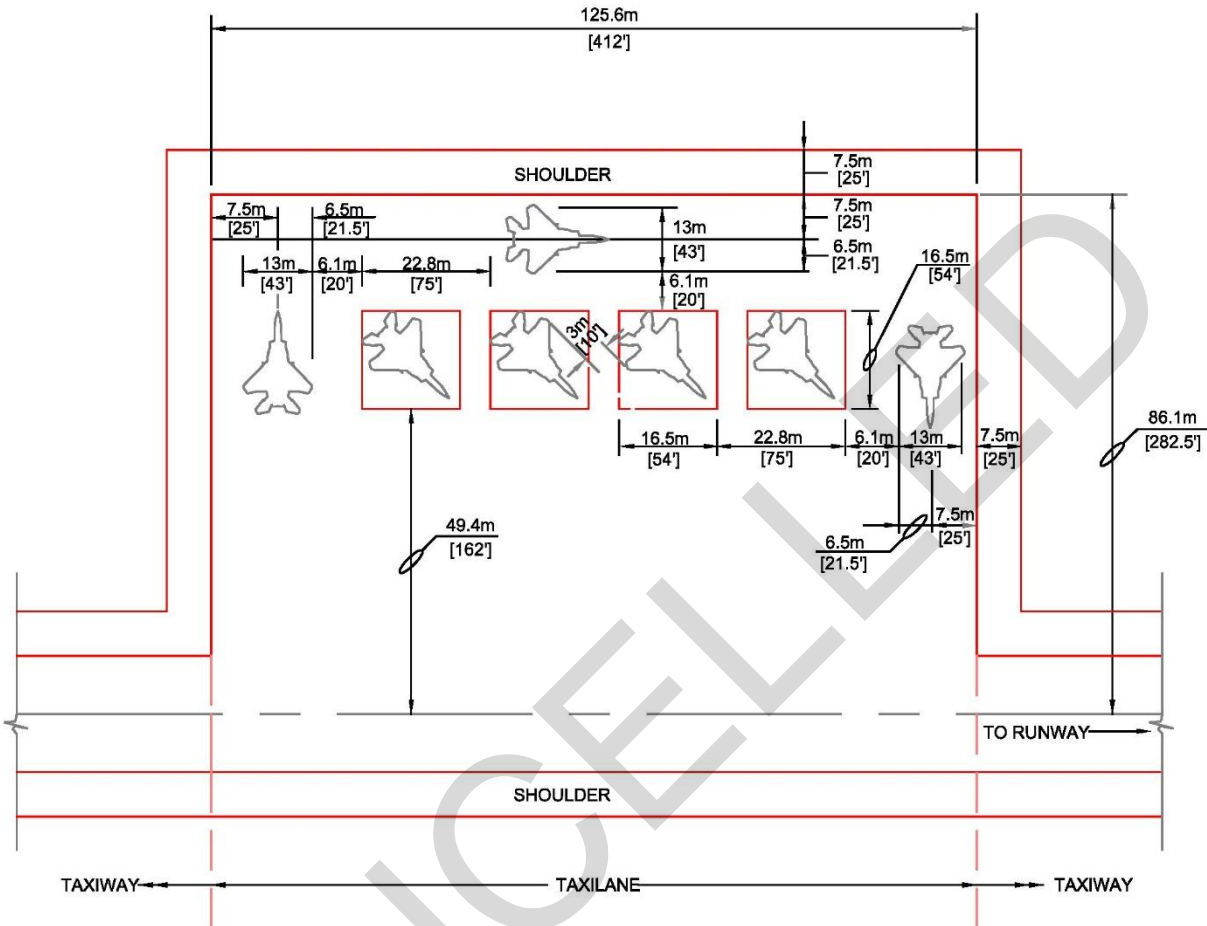
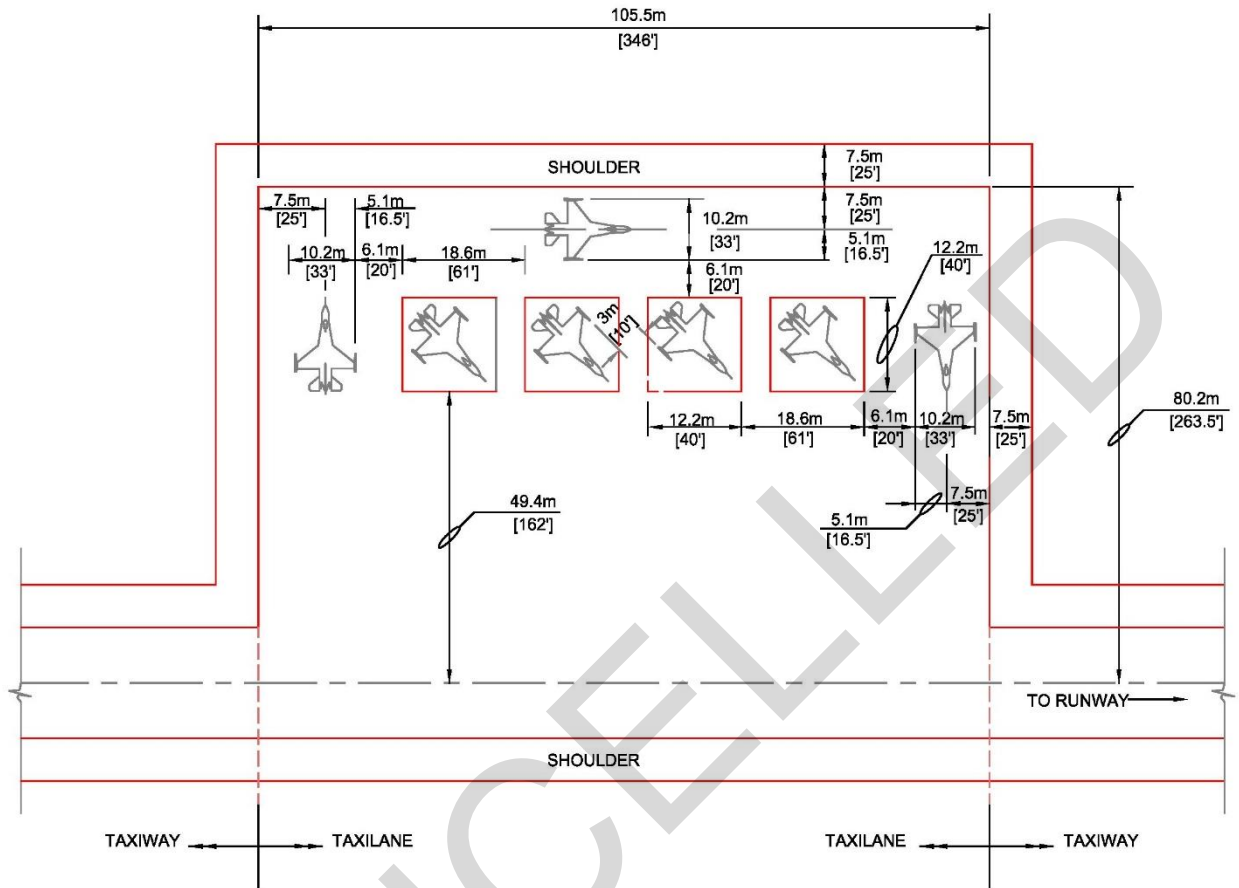

Figure 6-26. Arm-Dearm Pad for F-16 Fighter



N.T.S.

Figure 6-27. Arm-Dearm Pad for F-22 Fighter

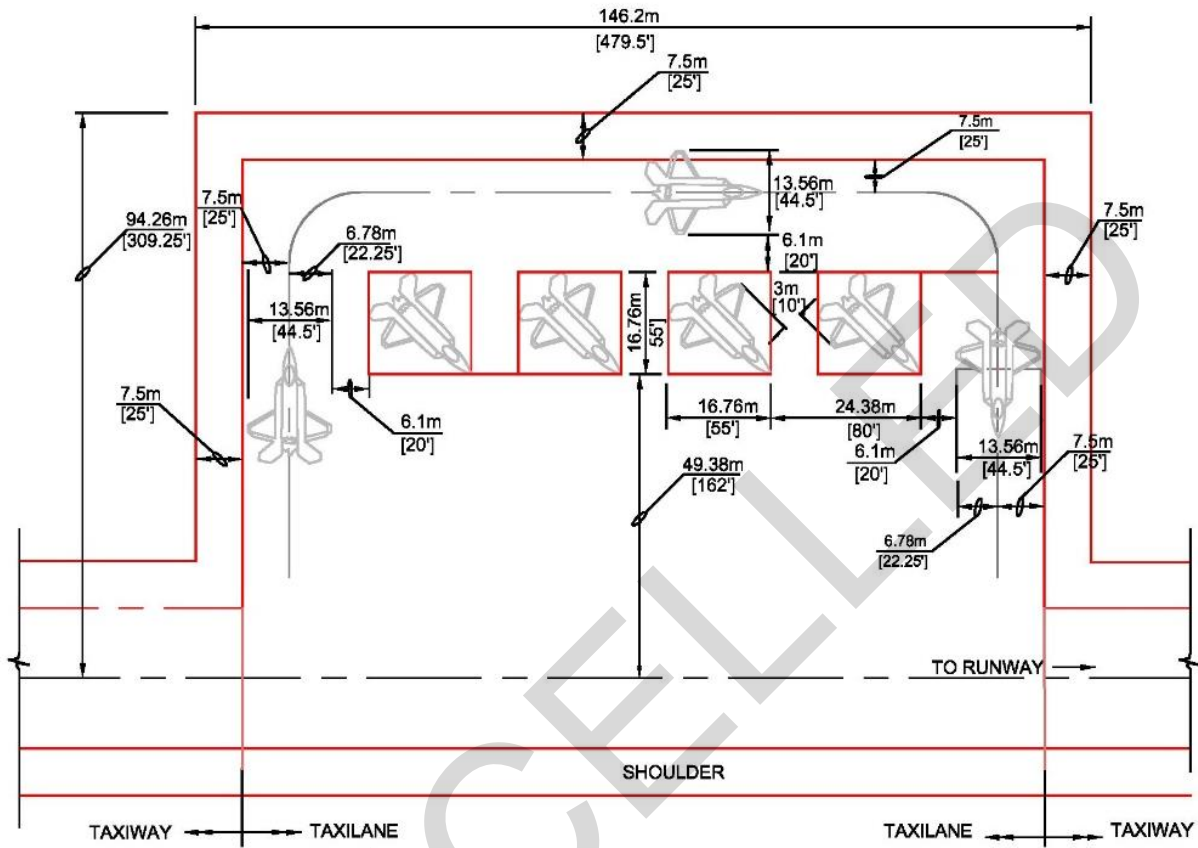
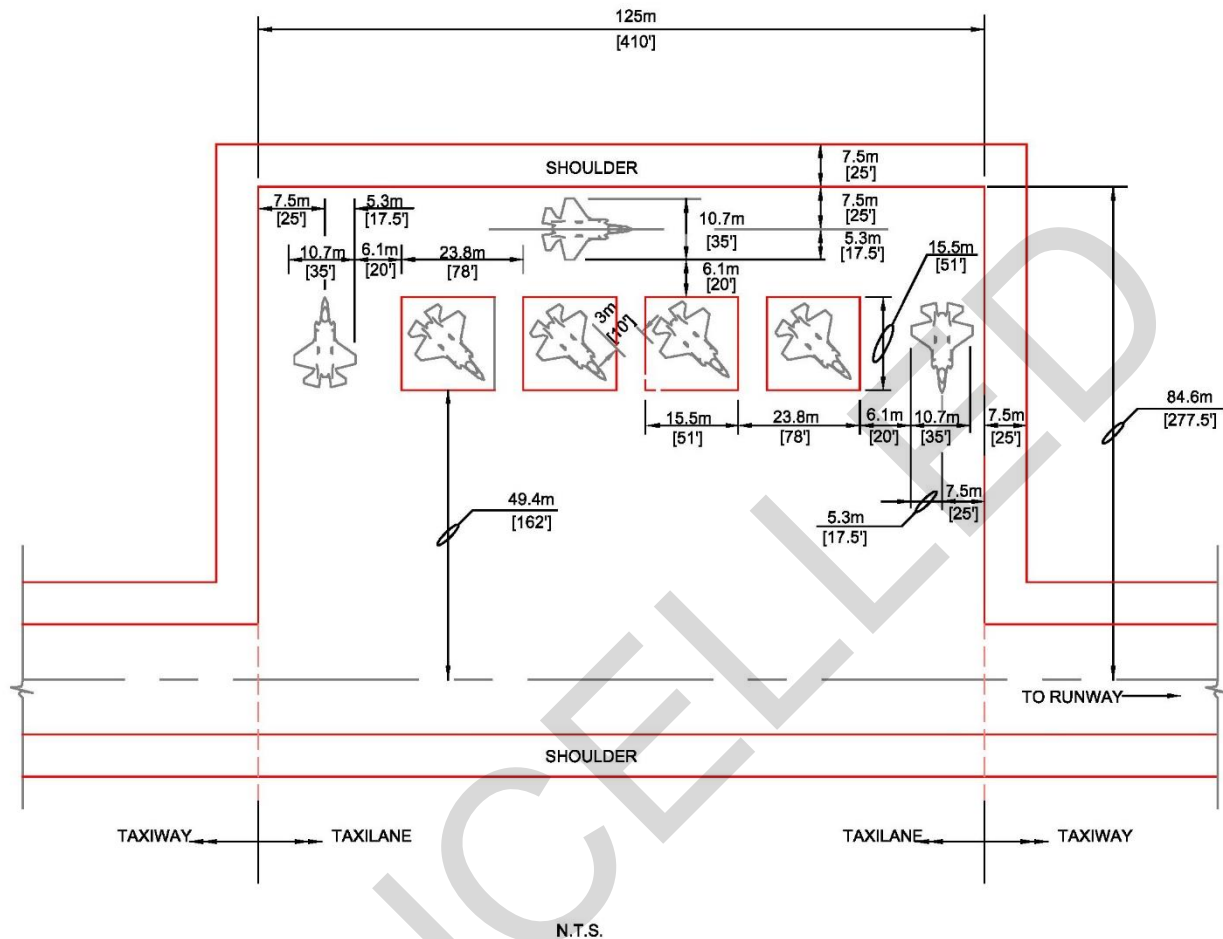

Figure 6-28. Arm-Dearm Pad for F-35 Fighter (JSF)



**6-11 COMPASS CALIBRATION PAD (CCP).**

An aircraft CCP is a paved area in a magnetically quiet zone where an aircraft's compass is calibrated.

**6-11.1 Army.**

A CCP is not required by the Army, but if one is provided, or used, then requirements of Paragraph 6-11 and applicable subparagraphs apply.

**6-11.2 Air Force.**

The Air Force has the option of using the criteria presented here or using the criteria provided in FAA AC 150/5300-13.



### **6-11.3 Navy and Marine Corps.**

Prior to construction of, or major repair of, a CCP, a validation of need shall be filed through the maintenance department to NAVAIR for approval. For CCP marking requirements, use the controlling aircraft NAVAIR Technical Manual or use the criteria contained in Appendix B, Section 10, for general purpose CCPs.

### **6-11.4 Location.**

The CCP should be located off the side of a taxiway at sufficient distance to satisfy the runway and taxiway lateral clearance distance and airspace criteria in Chapters 3, 4, and 5. Do not site CCPs, other aprons, hot cargo spots, or taxiways to these facilities in a way that will allow penetration of the approach-departure clearance surface.

### **6-11.5 Siting Consideration.**

#### **6-11.5.1 Separation Distances.**

To meet the magnetically quiet zone requirements and prevent outside magnetic fields from influencing the aircraft compass calibration, efforts must be taken to make sure that minimum separation distances are provided. See Appendix B, Section 10 for CCP separation distances.

#### **6-11.5.2 Preliminary Survey.**

During the site selection process, the proposed sites for CCPs must be checked for magnetic influences to ensure that the area is magnetically quiet regardless of adherence to separation distances. A preliminary survey as described in Appendix B, Section 10, must be conducted to determine if the proposed site is magnetically quiet. A survey similar to the preliminary survey must be conducted after construction of any new item or building, within or near the separation distances of the pad. This will ensure that the newly constructed item has not created new magnetic influences in the magnetically quiet zone.

#### **6-11.5.3 Magnetic Survey and Re-marking Requirements.**

The CCP magnetic survey is an airfield engineering survey used to ensure that the CCP area is magnetically quiet, to determine the magnetic variation (MagVar) of the area, and to layout the markings for the pad. A magnetic survey shall be conducted after construction of a new CCP and at regular intervals thereafter to ensure the CCP remains suitable for aircraft magnetic compass calibrations. The procedure to conduct magnetic surveys is outlined in Appendix B, Section 10.

##### **6-11.5.3.1 Magnetic Survey Frequency.**

Because the Magnetic North Pole is constantly moving, the MagVar at any location on the Earth is constantly changing at varying rates. Check the MagVar and the MagVar rate of change for any latitude/longitude using

<https://www.ngdc.noaa.gov/geomag/declination.shtml>. Every CCP must be re-surveyed periodically to update the MagVar, update the alignment with Magnetic North, and update the CCP markings. The CCP markings shall be removed and replaced when the new MagVar differs by more than 30 arc-minutes (0.5 degrees) from the existing CCP markings. In addition, periodic re-surveys ensure the CCP area remains a magnetically quiet zone, which is essential for accurate aircraft magnetic compass calibrations.

A CCP must be re-surveyed and the markings updated when the MagVar changes by more than 30 arc-minutes from the existing markings. For CCPs where the MagVar rate of change is low (7 arc-minutes or less per year), a re-survey must be conducted at an interval of 5 years or less. At locations where the MagVar rate of change is greater than 7 arc-minutes per year, more frequent re-surveys are required. Table 6-3 lists the re-survey frequency needed based on MagVar rates of change. If at any time the difference exceeds the tolerance of the aircraft compass or calibration equipment, the Airfield Manager may schedule a survey more frequently.

Periodic surveys to re-calibrate the marked directions on the CCP are required at a minimum every five years. In locations where the magnetic variation over time is high, more frequent re-calibration is required. Table 6-3 lists re-survey frequency needed to keep the difference between marked north and magnetic north less than 50 arc-minutes. If the difference exceeds the tolerance of the aircraft compass or calibration equipment, the Airfield Manager may schedule a survey more frequently.

**Table 6-3. Magnetic Survey Frequency Requirements**

Magnetic Variation Rate of Change [arc-minutes per year]	Re-Survey Frequency
≤ 7	5 years
8	4 years
9-10	3.5 years (42 months)
11	3 years
12-14	2.5 years (30 months)
15-18	2 years
≥ 19	1.5 years (18 months)

**6-11.5.3.2 Additional Information.**

The Naval Air Warfare Center-Aircraft Division (NAWCAD-4.5.3), an authority on CCPs, substantially contributed to this criteria. For additional information on CCP survey and maintenance, contact:

Naval Air Warfare Center-Aircraft Division  
NAWCAD-4.5.3, Core Avionics Engineering Division

Building 2187  
NAS Patuxent River, MD  
(301) 342-9122

**6-11.6 Compass Calibration Pad (CCP) Size.**

Typical CCP size is shown in Figure 6-29.

CANCELLED

Figure 6-29. Compass Calibration Pad

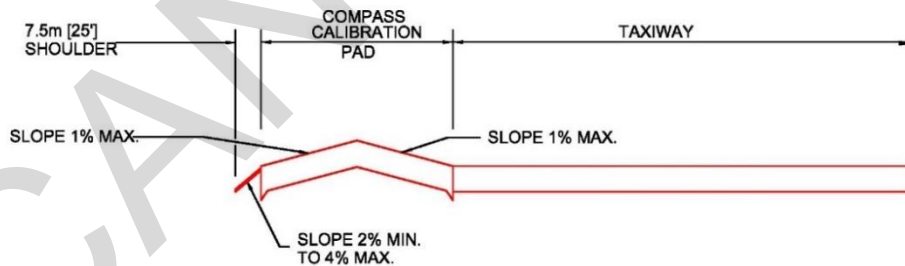
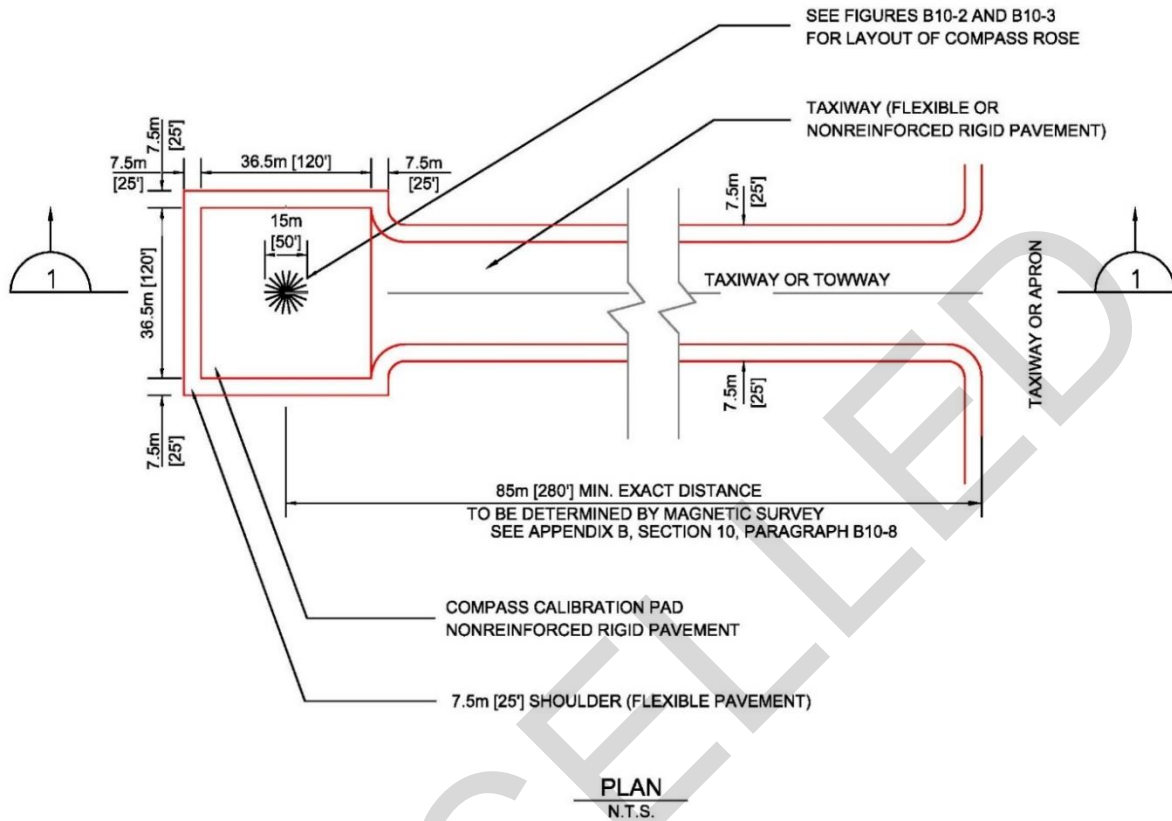

**NOTE**

THICKNESS OF CONCRETE AND BASE COURSE, BASE COURSE DENSITY, TYPE OF SHOULDER SURFACING AND CBR OF SHOULDER BASE COURSE ARE GOVERNED BY EXISTING CRITERIA OR ARE DEPENDENT UPON SITE CONDITIONS.



### **6-11.7 Access Taxiway/Towway.**

An access taxiway will be provided for access from the primary taxiway to the CCP. The access taxiway must be oriented to facilitate moving the aircraft onto the CCP on a magnetic north heading. At Army and Air Force aviation facilities, if the aircraft should be towed to the CCP, the access taxiway must be designed as a towway. At Navy and Marine Corps facilities, the taxiway should be designed as a taxiway. Taxiway and towway design requirements are presented in Chapter 5.

### **6-11.8 Grading.**

CCPs will be graded as specified in this section.

#### **6-11.8.1 Perimeter Elevation.**

The elevation of the perimeter of the pad will be the same elevation around the entire perimeter.

#### **6-11.8.2 Cross Slope.**

The CCP should be crowned in the center of the pad with a constant cross slope of 1% in all directions to provide surface drainage while facilitating alignment of the aircraft pad.

### **6-11.9 Tie-Down/Mooring Point.**

Do not place any aircraft tie-down/mooring points, tie-down/mooring eyes, or static grounding points in the CCP pavement.

### **6-11.10 Embedded Material.**

Due to the influence of ferrous metal on a magnetic field, the PCC pavement for the CCP and access taxiway must not contain any embedded ferrous metal items such as dowels bars, reinforcing steel, steel fibers, or other items. In addition, ferrous metal must not be placed in or around the CCP site.

### **6-11.11 Control Points.**

A control point will be set in the center of the CCP. This point will consist of a brass pavement insert into which a bronze marker is grouted in accurate alignment. This point will be stamped with "Center of Calibration Pad." The layout of the control points is discussed further in Appendix B, Section 10.

### **6-11.12 CCP Markings.**

See Appendix B, Section 10.

## **6-12 HAZARDOUS CARGO PADS.**

Hazardous cargo pads are paved areas for loading and unloading explosives and other hazardous cargo from aircraft. Hazardous cargo pads are required at facilities where the existing aprons cannot be used for loading and unloading hazardous cargo. Do not site hazardous cargo pads, other aprons, hot cargo spots, or taxiways to these facilities in a way that will allow penetration of the approach-departure clearance surface. A Hazardous Cargo Pad is not authorized in a Runway Clear Zone.

#### **6-12.1 Navy and Marine Corps Requirements.**

Hazardous cargo pads are not normally required at Navy and Marine Corps facilities; however, where operations warrant or an Air Force hazardous cargo aircraft is continuously present, hazardous cargo pads can be justified with proper documentation.

#### **6-12.2 Siting Criteria.**

Hazardous cargo pads require explosives site planning as discussed in Appendix B, Section 9.

#### **6-12.3 Hazardous Cargo Pad Size**

##### **6-12.3.1 Circular Pad.**

At aviation facilities used by small cargo aircraft, the hazardous cargo pad is a circular pad as shown in Figure 6-30.

##### **6-12.3.2 Semicircular Pad.**

At aviation facilities used by large cargo aircraft and at aerial ports of embarkation (APOE) and aerial ports of debarkation (APOD), the hazardous cargo pad is semicircular, as shown in Figure 6-31. The semicircular pad is adequate for aircraft up to and including the dimensions of the C-5.

##### **6-12.3.3 Other Pad Size.**

The hazardous cargo pad geometric dimensions as shown in Figures 6-30 and 6-31 are minimum requirements. Hazardous cargo pads may be larger than these dimensions if the design aircraft cannot maneuver on the pad. Sources for obtaining information concerning minimum turning radii for various aircraft are presented in Army USACE TSC Report 13-2..

#### **6-12.4 Access Taxiway.**

An access taxiway will be provided for access from the primary taxiway to the hazardous cargo pad. The taxiway should be designed for the aircraft to taxi into the hazardous cargo pad under its own power.

#### **6-12.5 Tie-Down and Grounding Points.**

Tie-down/mooring points and tie-down/mooring eyes must be provided on each hazardous cargo pad. Grounding points must be provided on each hazardous cargo pad. Tie-down and grounding points are discussed further in Appendix B, Section 11.

#### **6-12.6 Miscellaneous Considerations.**

These items need to be considered for hazardous cargo pads:

##### **6-12.6.1 Utilities.**

Telephone service, apron flood lighting, airfield lighting, and water/fire hydrants are required for safety.

##### **6-12.6.2 Access Road.**

Consider providing a paved roadway to the hazardous cargo pad for access by trucks and other vehicles.

#### **6-13 ALERT PAD.**

An alert pad, often referred to as an alert apron, is an exclusive paved area for armed aircraft to park and have immediate, unimpeded access to a runway. In the event of a declared alert, alert aircraft must be on the runway and airborne in short notice. This chapter will refer to both alert aprons and alert pads as "alert pads." An alert apron is shown in Figure 6-32. An alert pad is shown in Figure 6-33.

Figure 6-30. Hazardous Cargo Pad Other than APOE/Ds

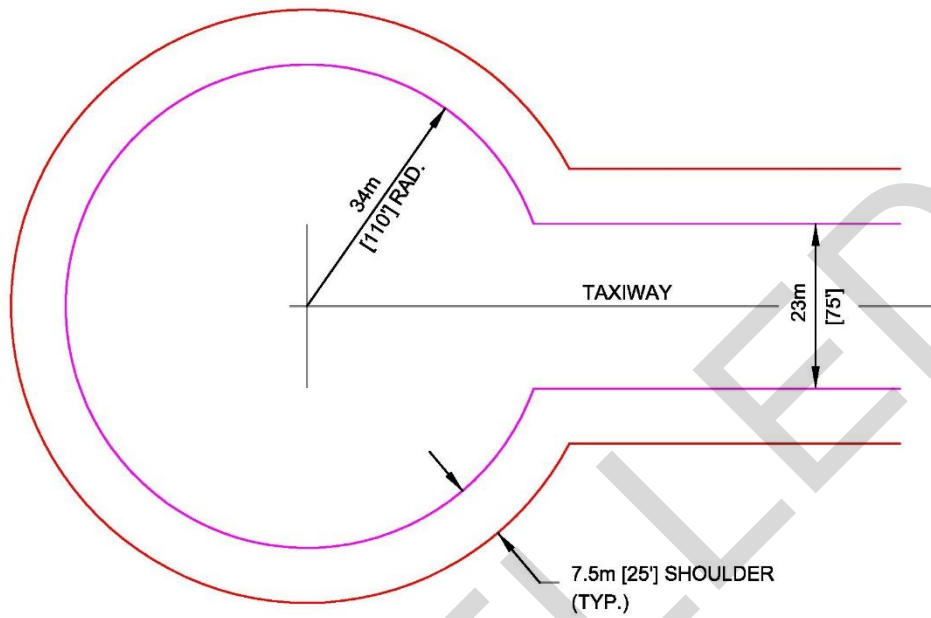
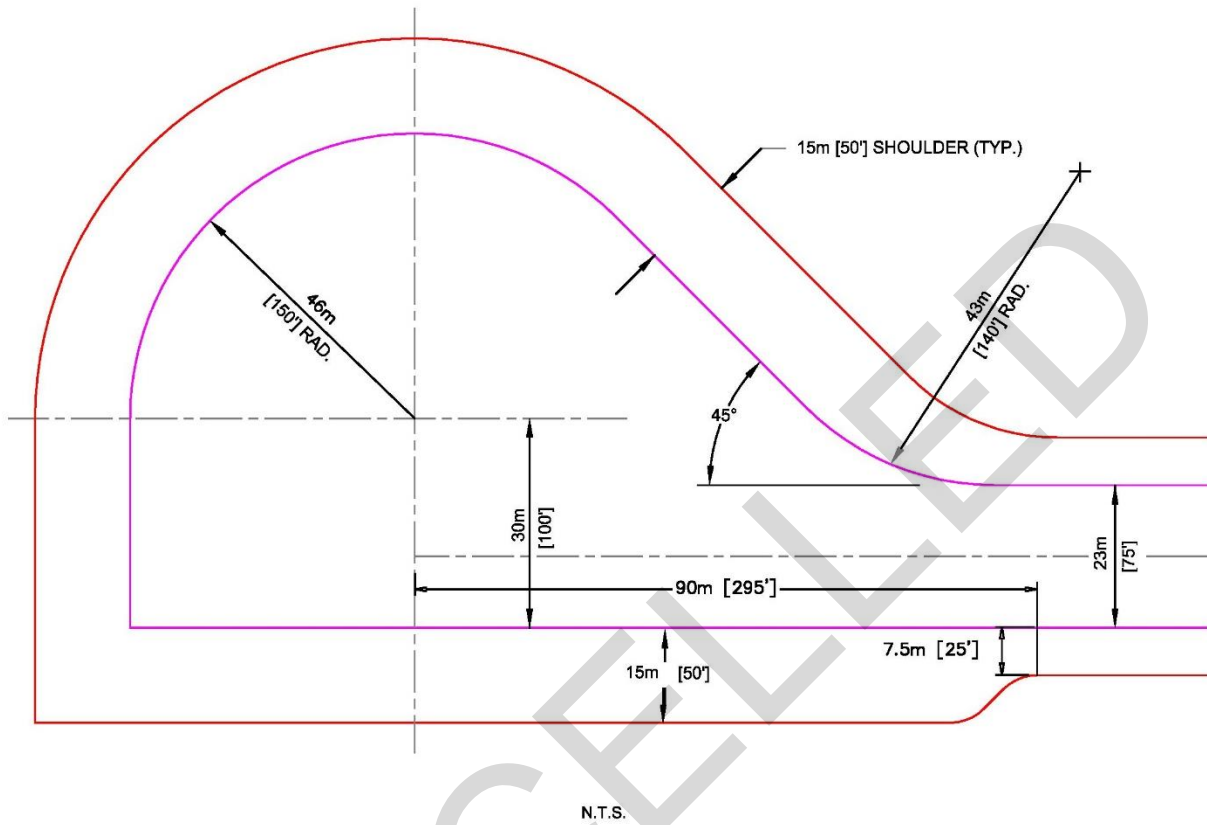



Figure 6-31. Typical Hazardous Cargo Pad for APOE/Ds



**NOTE**

THIS HAZARDOUS CARGO PAD IS ADEQUATE FOR AIRCRAFT UP TO AND INCLUDING THE C-5. THE DIMENSIONS MAY BE ADJUSTED TO ACCOMMODATE LIMITING CONSTRAINTS AT INDIVIDUAL FACILITIES.

Figure 6-32. Typical Alert Apron for Bombers and Tanker Aircraft

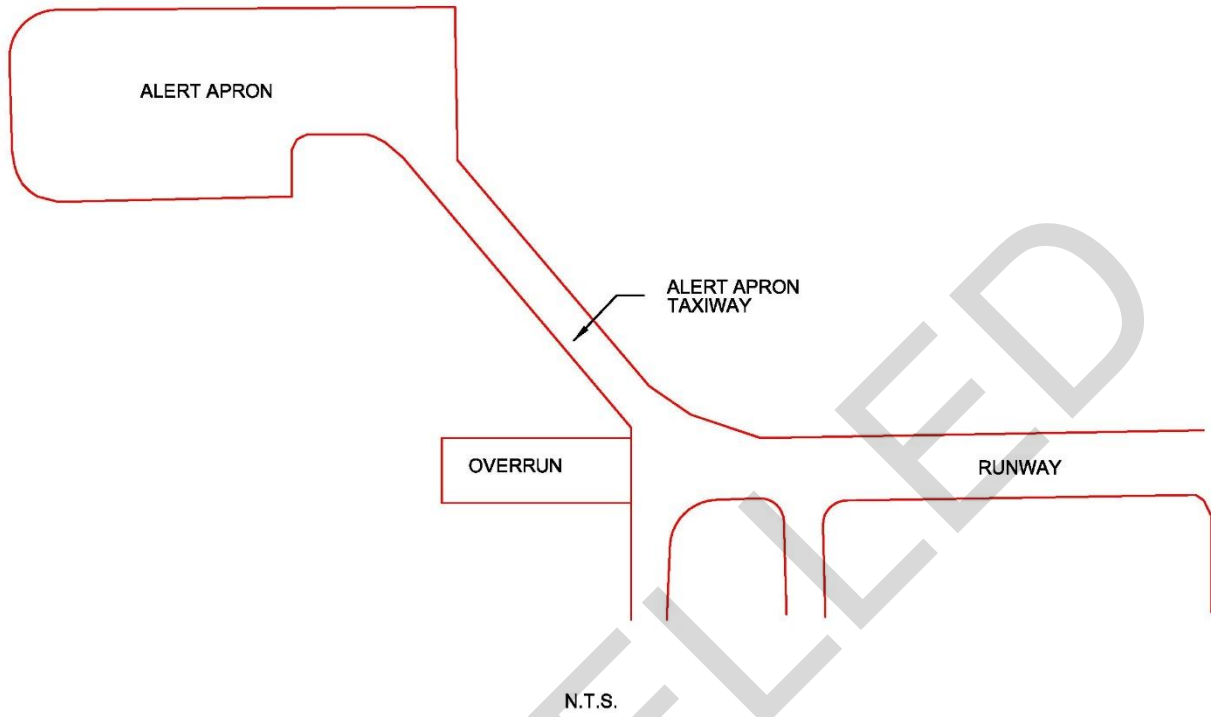
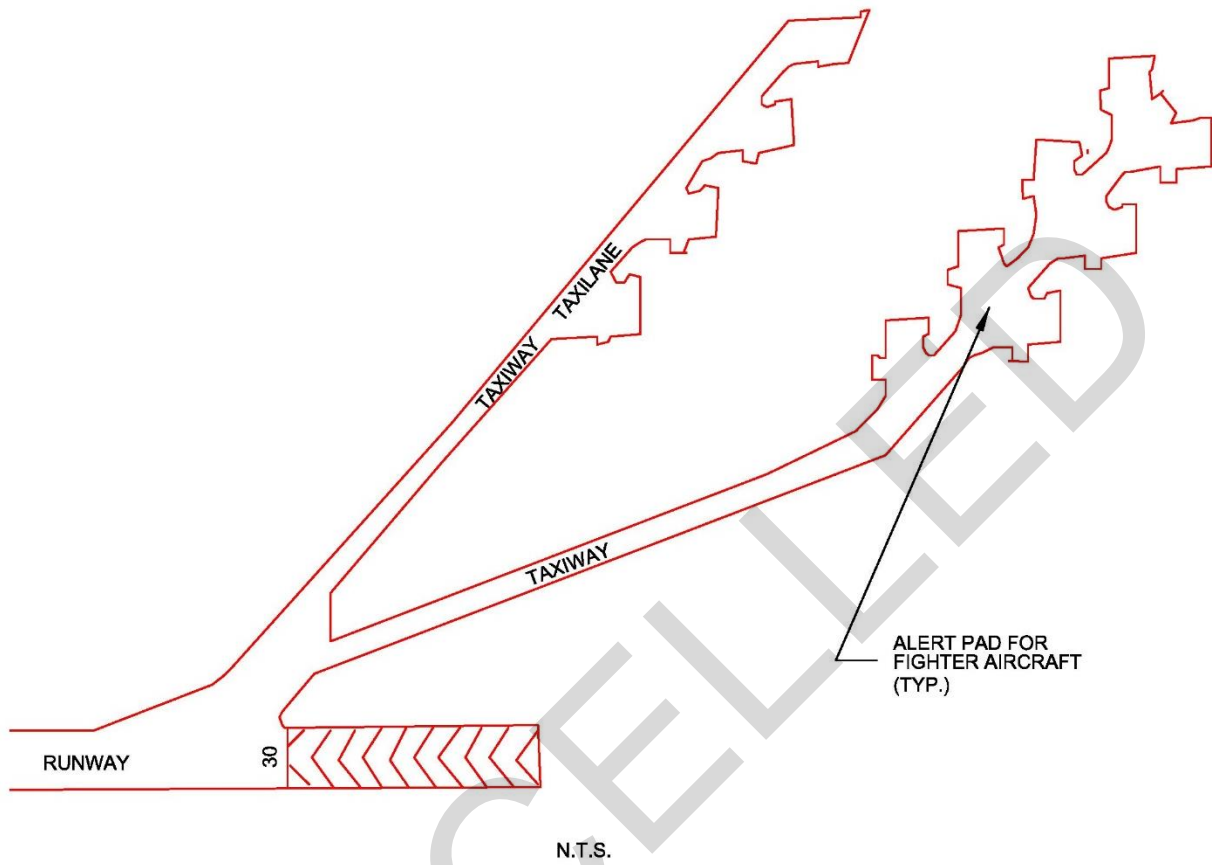

Figure 6-33. Typical Alert Pad for Fighter Aircraft



### **6-13.1 Navy and Marine Corps Requirements.**

Alert pads are not normally required at Navy and Marine Corps facilities. When justified, the criteria provided in this UFC will be used.

### **6-13.2 Location.**

Locating the alert pad adjacent to a runway end will allow alert aircraft to proceed directly from the apron to the runway threshold without interruptions from other traffic. Alert pads must be located close to the runway threshold to allow alert aircraft to be airborne within the time constraints stipulated in their mission statements. The preferred location of alert pads is on the opposite side of the runway, away from normal traffic patterns to allow aircraft on the alert pad direct, unimpeded access to the runway. Alert pads and alert aprons must not be located so that the aircraft or shelters are within the graded area of the clear zone, or penetrate the approach-departure clearance surface.

### **6-13.3 Siting Criteria.**

#### **6-13.3.1 Airspace Imaginary Surfaces.**

As discussed in paragraph 6-8.3.2, aircraft parked on alert pads must not project into airspace imaginary surfaces.

#### **6-13.3.2 Explosives Consideration.**

Aircraft loaded with explosives on alert pads should be located to minimize the potential for explosive hazards. Explosives safety site plans must be prepared for explosive-loaded alert aircraft. See Appendix B, Section 9.

### **6-13.4 Alert Pad Size.**

#### **6-13.4.1 General Dimensions.**

Alert pads should be sized to park all of the aircraft on alert. The dimensions of the pad should vary with the length and wingspan of the aircraft to be served and the explosives on the aircraft. Wingtip clearances, presented in Table 6-4, are minimum separation distances to be observed at all times.

**Table 6-4. Minimum Separation Distance on Tanker or Bomber Alert Aprons from the Centerline of a Through Taxiway to a Parked Aircraft**

Aircraft	Standard (m)	Standard (ft)	Minimum (m)	Minimum (ft)
B-52 or B-52 mixed force B-1 B-2	45.72	150	38.10	125
KC-46	41.91	137.5	34.29	112.5
KC-135	38.10	125	30.48	100
KC-10	30.48	100	22.86	75

**6-13.4.2 Air Force Waivers.**

**6-13.4.2.1 Wingtip Clearances.**

The MAJCOM may grant waivers to the 15.24 m (50 ft) wingtip clearance requirement when sufficient ramp area is not available. In no case will the wingtip clearance be waived to less than 9.14 m (30 ft).

**6-13.4.2.2 Wingtip Clearances Based on Taxiway Width.**

When the minimum separation distance between a taxiway centerline and the nose/tail of a parked aircraft is reduced below the distance shown in Table 6-1, the minimum waiver wingtip clearance distance of 9.14 m (30 ft) must be increased 0.3 m (1 ft) for each 0.3-m (1-ft) reduction in separation distance. Example: Referencing Table 6-4, the standard B-52 nose to taxiway centerline distance is 150 ft. If a B-52 nose to taxiway centerline is 43 m (140 ft)—minimum waiver wingtip distance 12 m (40 ft), adding the reduction in separation distance (10 ft) to the minimum waiver wingtip clearance (30 ft); if the nose to centerline distance is 40 m (130 ft) or less—no waiver permitted or required, since the reduction in separation distance (20 ft) added to the minimum waiver wingtip clearance (30 ft) would equal 50 ft, the standard wingtip clearance requirement, therefore for value of 130 ft or less, comply with 15-m (50-ft) minimum wingtip clearance.

**6-13.5 Design Aircraft.**

To facilitate flexibility in future operations, new alert ramp construction should conform to B-52 standards. Aircraft parked in shelters are exempt from the parking separation criteria in 6-13.4.2.1.

**6-13.6 Alert Aircraft Parking Arrangements.**

**6-13.6.1 Fighter Arrangements.**

Fighter aircraft are parked at 45-degree angles to dissipate the heat and velocity of jet blast.

**6-13.6.2 Non-Fighter Arrangements.**

Non-fighter aircraft should be parked in rows.

**6-13.7 Jet Blast Distance Requirements.**

Jet blast safe distances should be considered when planning and designing parking locations on alert pads. Safe distance criteria are presented in Appendix B, Section 7.

**6-13.8 Taxi-In/Taxi-Out Capabilities.**

Alert aprons and pads should be designed either for taxi-in/taxi-out parking or for push-back parking. Taxi-in/taxi-out parking, shown in Figure 6-34, is preferred because alert aircraft can be taxied quickly into position under their own power. Back-in parking, shown in Figure 6-35, requires less paved area.

**6-13.9 Turning Radius.**

The turning radius on alert pad taxilanes will be designed to provide the minimum allowable turn under power of the largest aircraft that will use the alert pad. In no case will the initial turnout from the alert apron parking space to the through taxilane exceed 90 degrees. For Air Force alert pads for bombers and tankers, the initial turn radius from the parking space will equal the distance from the taxilane centerline to the nose of the aircraft. This is shown in Figure 6-34.

Figure 6-34. Alert Apron Taxi-In/Taxi-Out Parking

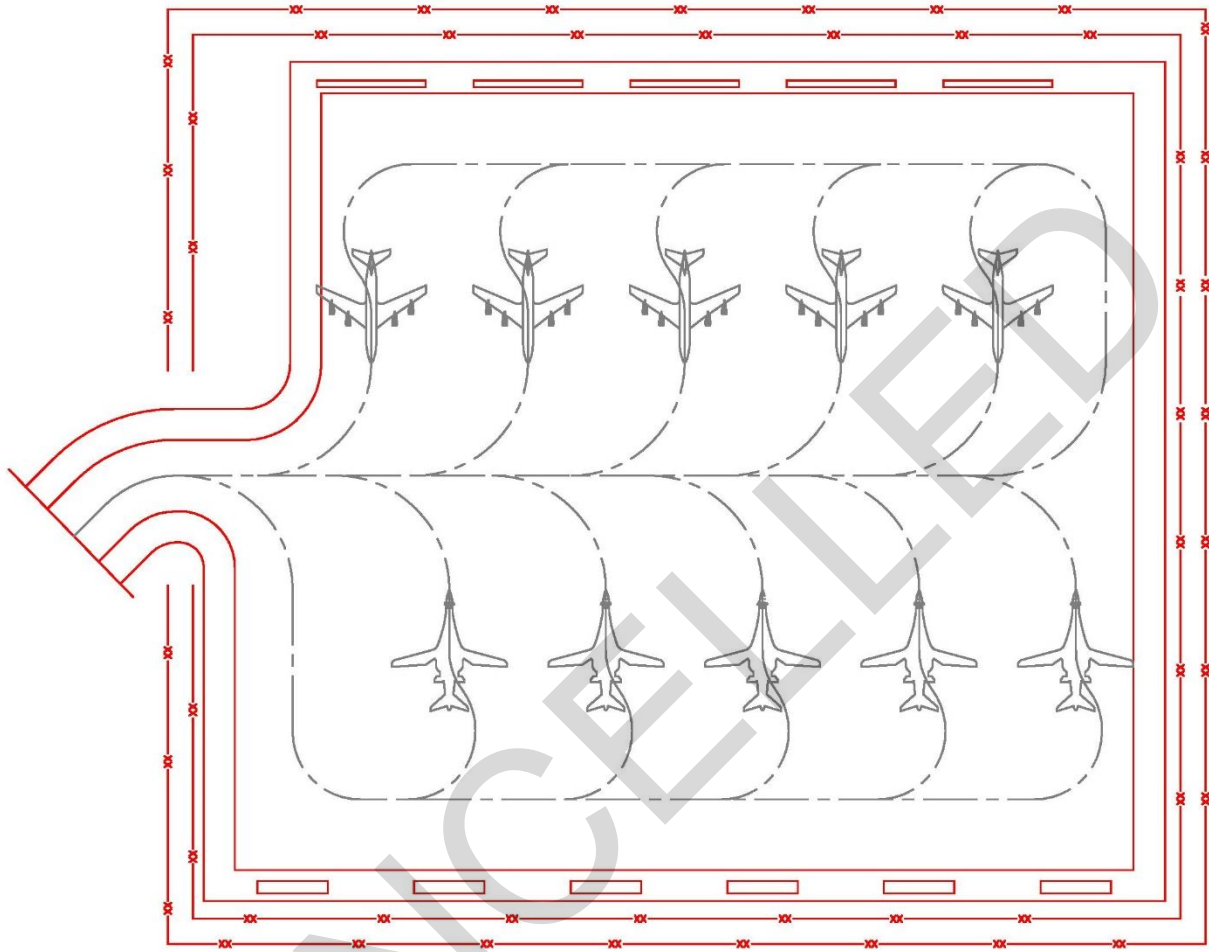

N.T.S.

Figure 6-35. Alert Apron Back-In Parking

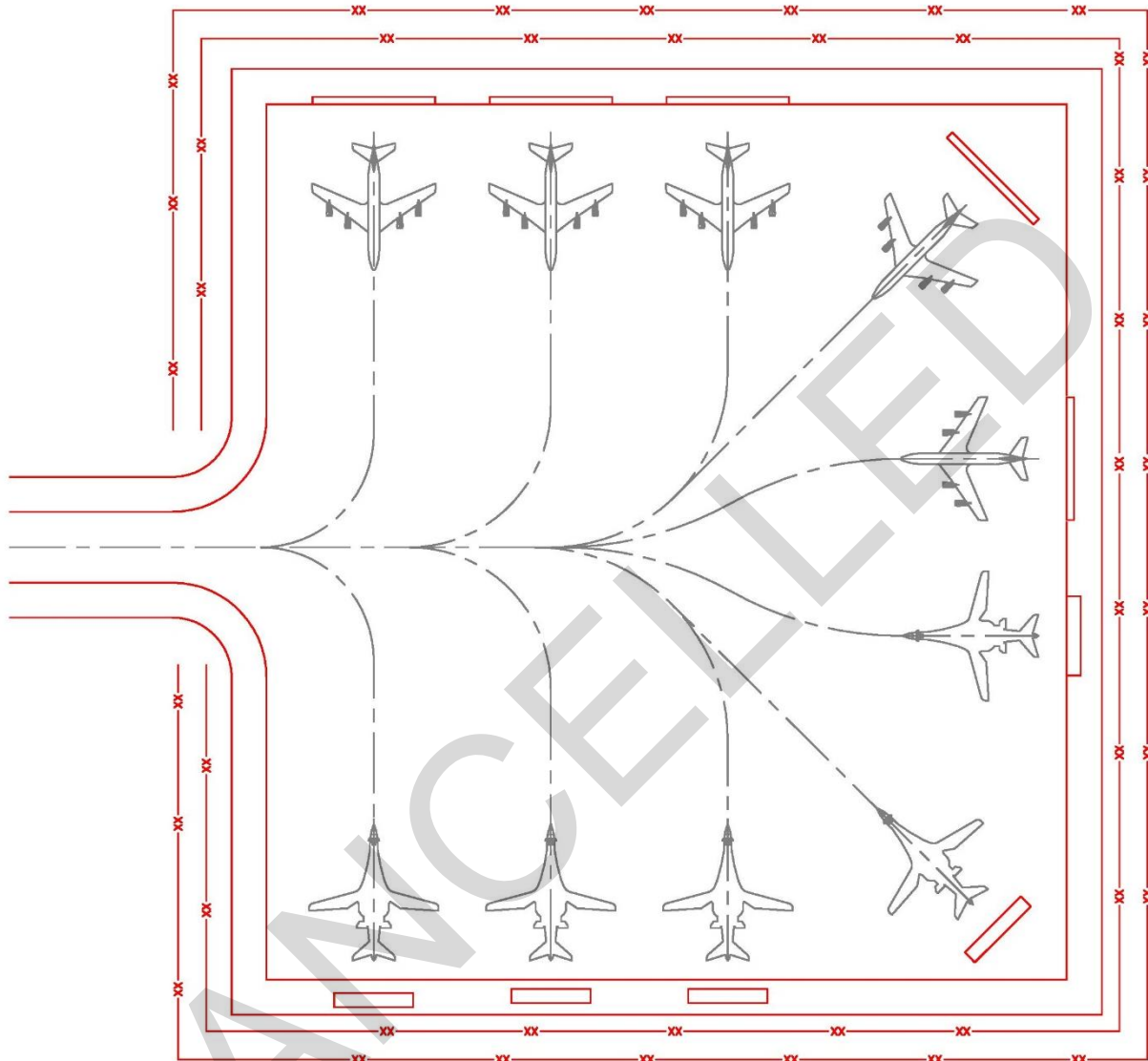

N.T.S.

### 6-13.10 Dedicated Access Taxiway.

At alert pads, provide a single dedicated taxiway from the alert pad to the runway for aircraft to progress directly without traffic interruptions. Having no other taxiways intersect the dedicated taxiway is the ideal way to ensure that the dedicated taxiway is not obstructed.



### **6-13.11 Tie-Down and Grounding Points.**

Tie-down/mooring points, tie-down/mooring eyes, and grounding points will be provided at each aircraft parking location as discussed in Appendix B, Section 11.

### **6-14 AIRCRAFT WASH RACKS.**

Aircraft wash racks are paved areas or facilities provided at all aircraft base facilities for the purpose of cleaning aircraft in conjunction with periodic maintenance and corrosion control activities.

This Section applies to Exterior Aircraft Wash Racks which are defined as open (non-environmentally controlled), covered or uncovered paved areas designed for the purpose of washing aircraft. Where required, the wash rack must be provided with a cover to protect the aircraft from sun induced heat or inclement weather preventing efficient wash operations. Interior Aircraft Wash Racks are addressed in UFC 4-211-02, Aircraft Corrosion Control Facilities.

#### **6-14.1 Location.**

Covered and uncovered aircraft wash racks should be located adjacent to the hangar area or maintenance facilities and contiguous to aircraft parking or access aprons. Existing pavements can be used where curbing can be installed, drainage adjusted as necessary, and other required facilities such as utilities can be provided to make a usable wash rack. Where possible, wash racks should be located near existing facilities where existing utility and pollution control systems are accessible. In siting wash racks, support facilities such as pump houses and tanks should be located either outside apron clearance distances or below grade. Follow aircraft wingtip clearance requirements presented in this chapter for siting the washrack in relation to parked aircraft and adjacent facilities.

#### **6-14.2 Size and Configuration.**

There are two standard shapes of wash racks for fixed wing aircraft as indicated in Figures 6-37 and 6-38: Type F, which accommodates fighters and other small aircraft; and Type L, which accommodates heavy bombers and large cargo aircraft. The Wash Rack Selection Chart, Figure 6-36, may be used to assist in determining the Wash Rack Type. Figure 6-40 represents a wash rack for rotary-wing facilities.

At mixed mission facilities, it may be possible to accommodate several smaller (fighter) aircraft on one larger Type F aircraft wash rack pavement. Size the pavement area to accommodate the larger of four small aircraft or one larger aircraft. The dimensions for wash racks to accommodate multiple smaller aircraft must include the minimum clearances indicated between aircraft and from the aircraft to the curb.

**Figure 6-36. Wash Rack Selection Chart**

		AIRCRAFT WINGSPAN or ROTOR DIAMETER											
		0' - 20'	20' - 40'	40' - 60'	60' - 80'	80' - 100'	100' - 120'	120' - 140'	140' - 160'	160' - 180'	180' - 200'	200' - 250'	
AIRCRAFT LENGTH	0' - 20'	Normal Aspect Ratio (L/WS)											
	20' - 40'			MQ-1	MQ-9					Long Wingspan			
	40' - 60'		F-16 F-35	A-10 C-12	F-15	E-2		RQ-4C MQ-4C					Type "F"
	60' - 80'			F-22 UH-60			U-2			B-2			
	80' - 100'				CH-47 CH-53	CH-53K (future)		C-130					
	100' - 120'					P-3	C-40	MC_130					
	120' - 140'							C-135 KC-135 P-8					
	140' - 160'							B-1	E-3, E-6 E-8		B-52		
	160' - 180'		Long Length							KC-46	C-17		
	180' - 200'										KC-10		Type "L"
	200' - 250'											E-4 (AF-1)	C-5A

NOTE: SEE FIGURE 6-40 FOR HELICOPTER WASH RACKS. HOWEVER, DUAL USE (FIXED AND ROTARY WING) WASHRACKS MAY USE FIGURE 6-36.

Figure 6-37. Wash Rack Type "F"

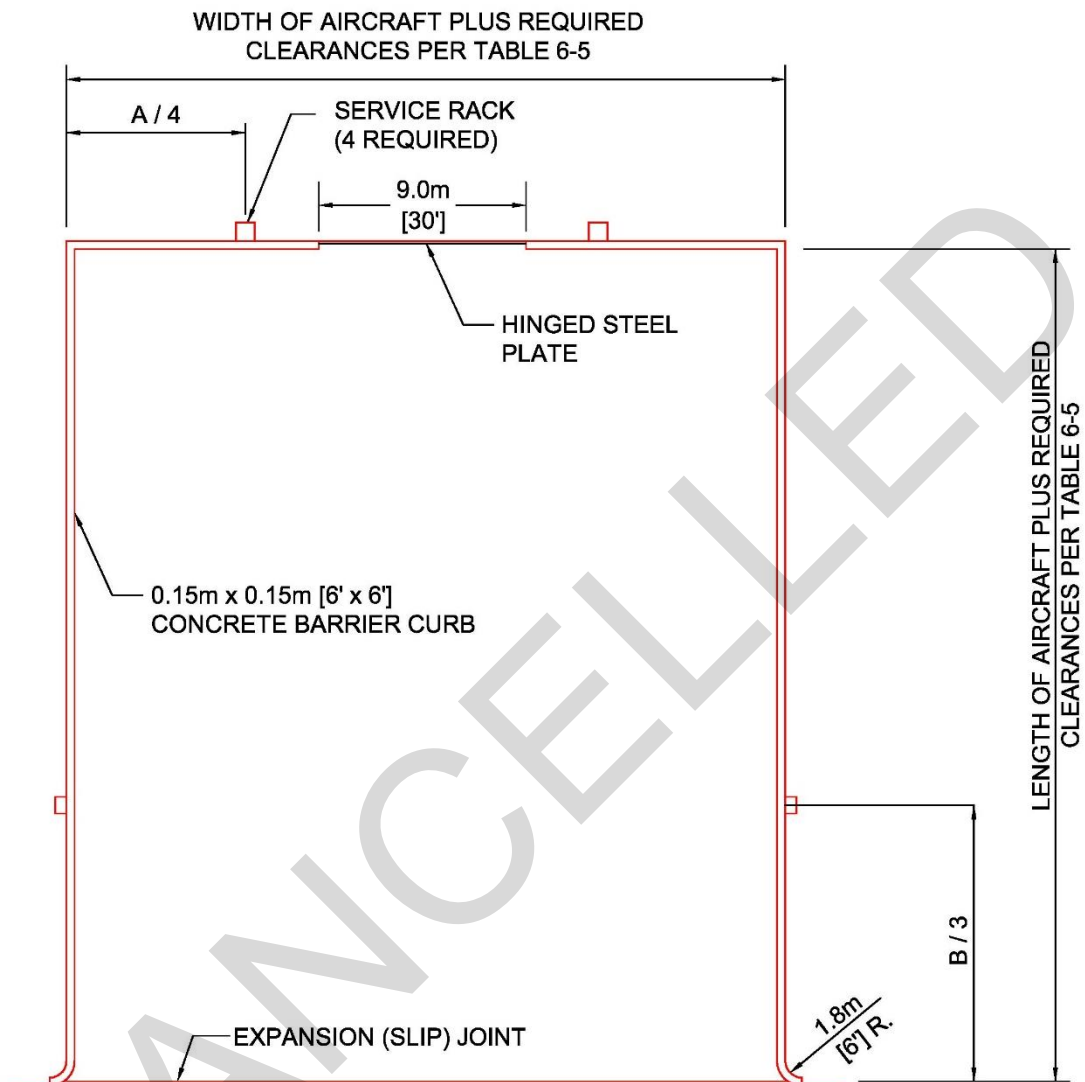

N.T.S.

Figure 6-38. Wash Rack Type "L"

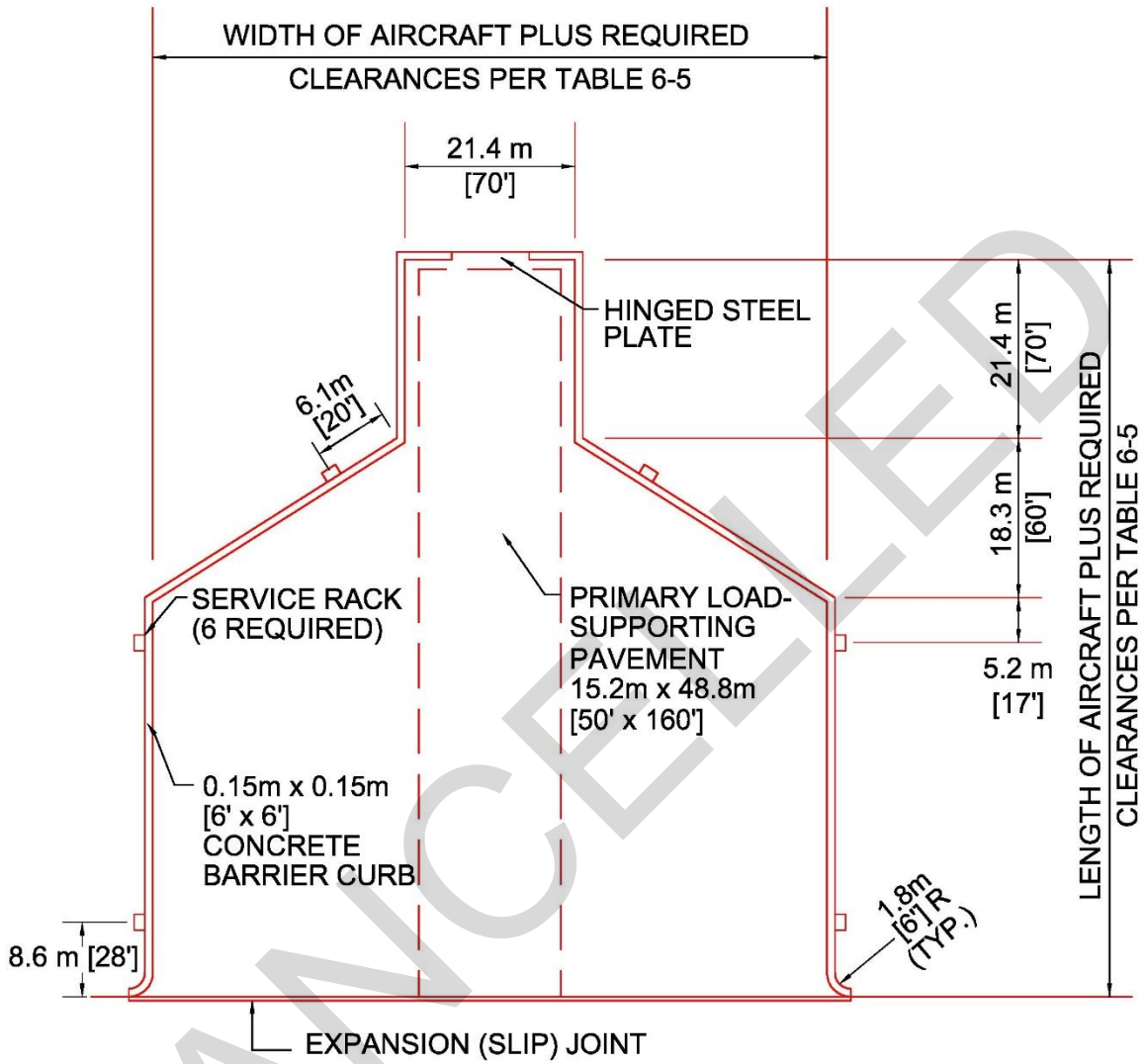

N.T.S

Figure 6-39. Utilities and In-Pavement Structures

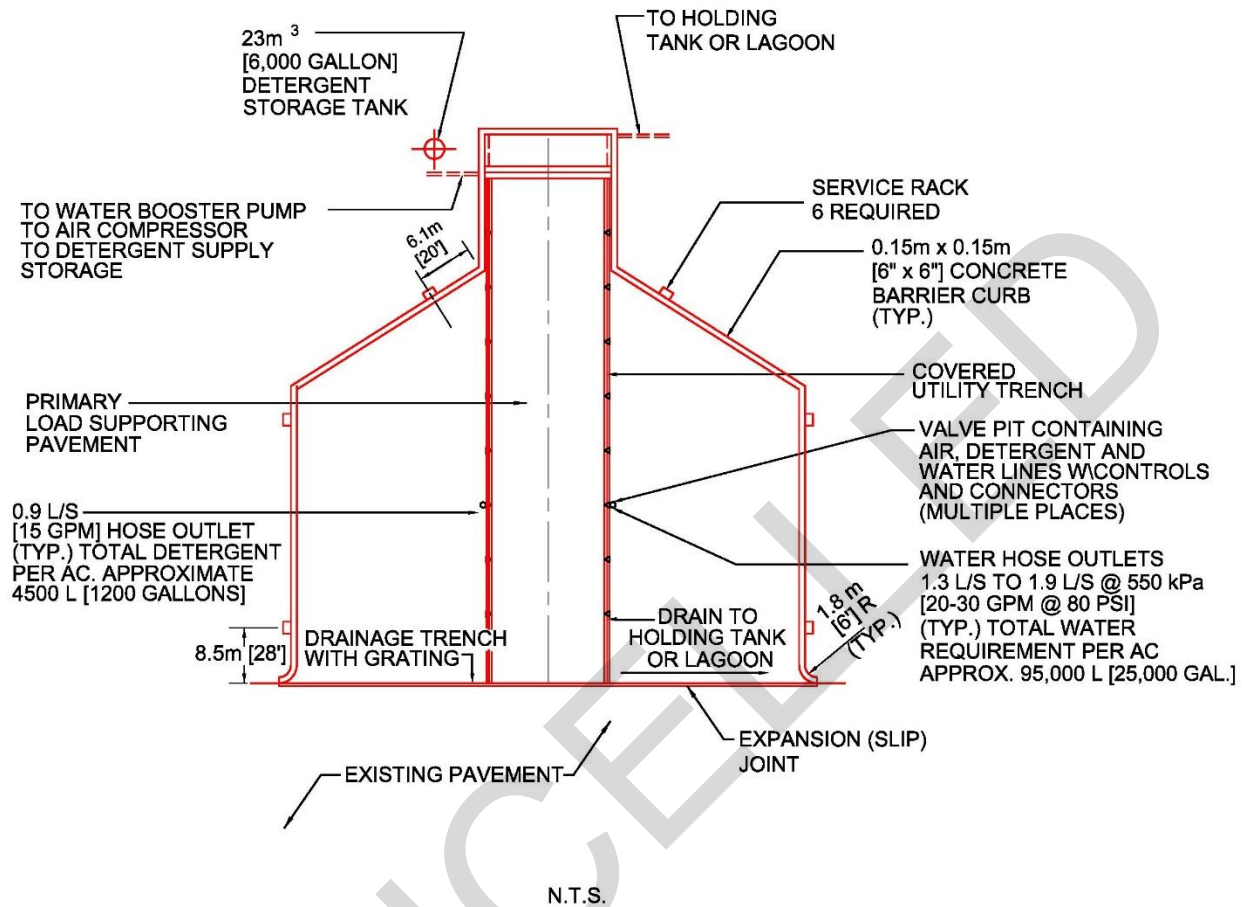
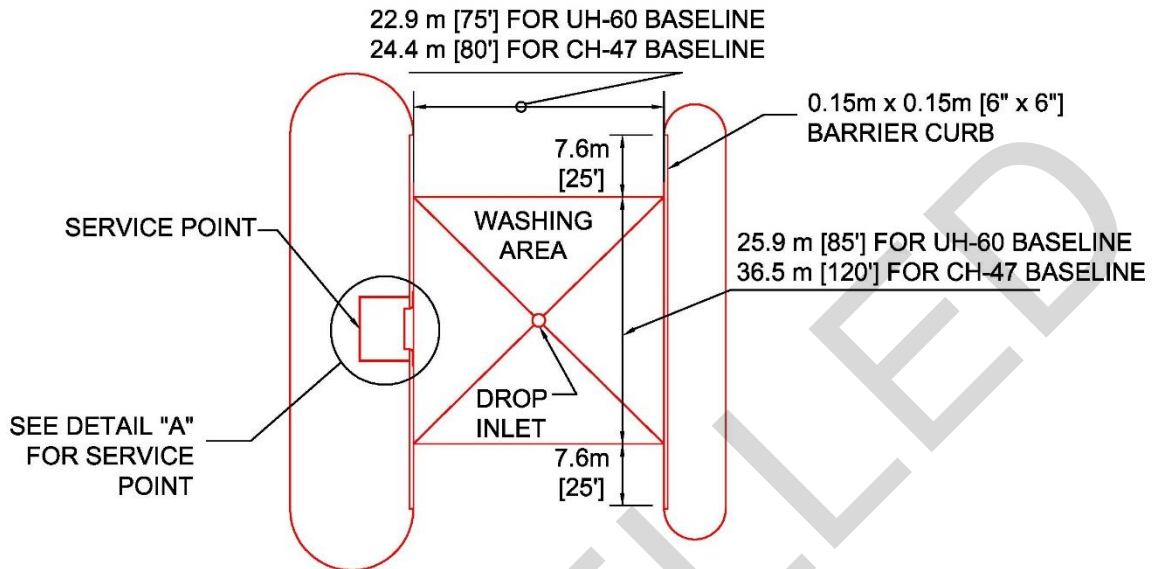
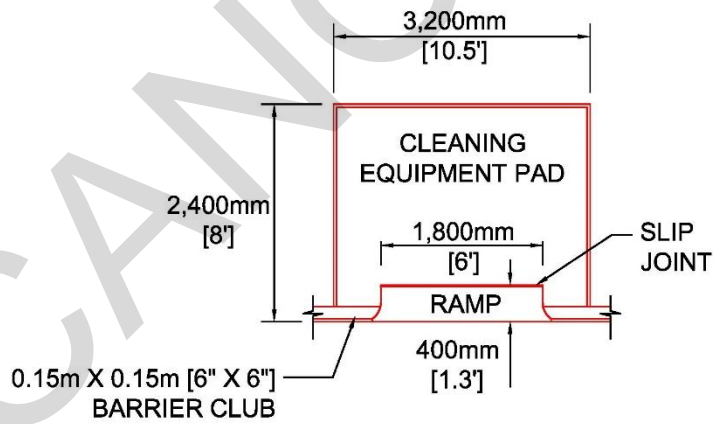

Figure 6-40. Helicopter Wash Rack (Single Helicopter)



**PLAN**  
N.T.S.



**DETAIL A**  
N.T.S.

### 6-14.3 Wash Rack Size.

The size and configuration of an aircraft wash rack is determined by the type of mission aircraft expected to use it. The dimensions of the largest aircraft plus the clearances shown in Table 6-5 determine the minimum wash rack pavement dimensions. At mixed mission facilities, it may be possible to accommodate several smaller (fighter) aircraft on one larger aircraft wash rack pavement.

**Table 6-5. Wash Rack Clearances From Aircraft to Curb**

Wash Rack Clearances From Aircraft to Curb					
Aircraft	From	To	Direction	Distance (m)	Distance (ft)
Heavy bomber, medium bomber, and cargo	Wingtip	Curb	Horizontally	4.6	15
	Tail	Curb	Horizontally	4.6	15
	Nose	Curb	Horizontally	4.6	15
Fighter	Wingtip	Curb	Horizontally	3.1	10
	Tail	Curb	Horizontally	3.1	10
	Nose	Curb	Horizontally	3.1	10
Helicopter	Rotor-tip	Curb	Horizontally	See note 1.	See note 1.
	Tail	Curb	Horizontally	See note 2.	See note 2.
	Nose	Curb	Horizontally	See note 3.	See note 3.

**NOTES:**

1. For light to medium helicopter (UH-60 baseline), the width of the wash rack is based on the addition of 3.1-m (10-ft) buffers to the rotor diameter. For heavy helicopter (CH-47 baseline), the width of the wash rack is based on the addition of 3.1-m (10-ft) buffers to the rotor diameter. For wash racks servicing multiple aircraft, a 6.1-m (20-ft) buffer is required between rotor tips.
2. 3.1 m (10 ft) for light and medium helicopter (UH-60 baseline). 10.4 m (34 ft) for heavy helicopter (CH-47 baseline).
3. 6.7 m (22 ft) for light and medium helicopter (UH-60 baseline). 10.4 m (34 ft) for heavy helicopter (CH-47 baseline).

### 6-14.4 Wash Rack Facilities.

The wash rack should consist of these required items:

- Paved surface
- Concrete curbs
- Paved shoulder (for rotary-wing only)
- In-pavement structures

- Wastewater collection
- Wastewater treatment
- Utility control building
- Utilities

#### **6-14.5 Wash Rack Grading.**

The pavement surface of the wash rack will be sloped at 1.5% to assure positive drainage to waste drains. UFC 3-260-02 *Pavement Design for Airfields* addresses configuration and grading criteria for aircraft wash racks. Wash racks are considered as Type “C” traffic area. See UFC 3-260-02 for type “C” traffic area requirements.

#### **6-14.6 Tie-Down and Grounding Points.**

Tie-down/mooring points, tie-down/mooring eyes, and grounding points are not required for wash racks.

#### **6-14.7 Concrete Curbs.**

Concrete curbs will be constructed on the perimeter of the wash rack pavement to confine wastewater to the wash rack pavement. Do not install curbs in wash racks which must be built within an active apron due to mission or space constraints. At these locations, concrete trenches with heavy duty flush metal grating must be utilized to carry the wash water to the central holding basin separator, or pump pit. The existing slope should be utilized as much as possible to minimize the amount of concrete apron which must be replaced.

#### **6-14.8 Service Points.**

##### **6-14.8.1 Army and Air Force.**

Wash racks are designed with service points incorporated into the pavement floors. The following in-pavement structures should be considered for wash rack design:

- Valve pits containing air, detergent, and water lines with controls and connectors
- Water hose outlets
- Covered utility trench
- Service rack – Point of service for wash rack equipment (i.e. hose reels, high pressure nozzle sprayers, etc.)

Typical locations for these structures are shown in Figure 6-39.

##### **6-14.8.2 Navy and Marine Corps.**

Wash rack service points are required for the Navy and Marine Corps.



## **6-14.9 Wash Rack Utilities.**

### **6-14.9.1 Required Wash Rack Utilities.**

Aircraft wash racks contain utilities that are not normally considered in airfield geometric design; however, the designer may need to be aware that they are an integral part of the wash rack. Design guidance for these utilities has not been included in this UFC. The following utilities are considered integral to the design of the Wash Rack and must be provided to the service outlets located along the perimeter as noted in the diagrams provided:

- Hot and cold water
- Detergent/Water solution
- Compressed Air
- Electrical power as required for portable lighting and/or portable hot water generating systems

Utilities must be run from the Utilities Control Building (or other enclosed mechanical space) to the Wash Rack via below grade installation or Service Trenches. Portable hot water generating systems may be utilized in lieu of a permanent water heater and tank arrangement. Designers must check the maximum flow rates required for mission aircraft and size utilities appropriately. Provide freeze protection for areas where environmental conditions require. Ensure backflow prevention is included to create positive separation from the potable water system.

### **6-14.9.2 Utility Controls Building.**

Wash Racks are generally supported by an adjacent Utilities Control Building. This building houses detergent make-up equipment, a detergent mixing tank, a water heater, pumps, and operating controls. An enclosed space inside the nearby serving hangar may also be utilized to house the Wash Rack mechanical equipment. Storage and sanitary facilities may also be provided as the operational requirements dictate. The Utilities Control Building must be located a sufficient distance away from the Wash Rack to preclude fire hazards associated with heating and associated electrical equipment.

### **6-14.9.3 Service Utility Connections (Service Points).**

Wash racks must be provided with an adequate number of service utility connections proportionate to the number of personnel required to wash the aircraft. The service connections must be installed in sub-surface pits and include all appropriate valving for each service with the appropriate number of outlets with quick disconnects. Typical locations for the Service Points are shown in Figure 6-39. Electrical outlets, where required, will be provided in separate or isolated pits appropriately designed for subsurface electrical installations.

#### **6-14.9.4 Lighting.**

Provide exterior lighting at the washrack at a minimum of 50-foot candles (FC) to accommodate night washing operations. Lighting can be provided via either installed or portable systems. Portable lighting equipment as allowed by and coordinated with ramp operations is recommended for active flight line areas. If the wash operation is of a reduced and non-elevated scale, consideration may be given to the reduction in light level down to a minimum of 25 FC. A safe environment for the operating personnel, however, is primary and must be considered first and foremost in equipping the wash rack with lighting.

#### **6-14.9.5 Wastewater Collection/Treatment.**

Locate waste drains in the center of the wash rack pavement to collect wash water contaminants (oils, alkaline, salts, and other contaminants) generated from aircraft washing operations. Off-center waste and trench drains are permitted only where necessitated by the aircraft landing gear configuration or where the off-center drains reduce construction costs or suit existing conditions. Sewers must drain wastewater from waste drains to a holding tank sized appropriately for the anticipated workload or flow. Due to the wash soap, the tank will not act as oil water separators. Oil-water separators or other water treatment/disposal systems appropriate for the expected contaminants must be incorporated into the wash facility design.

#### **6-14.9.6 Wastewater System Design.**

Wastewater collection/treatment systems must be designed in accordance with the following documents:

- UFC 3-240-01, *Wastewater Collection*
- UFC 4-832-01N, *Design: Industrial and Oily Wastewater Control*

Provide diversion systems for rainfall events to prevent treating excessive amounts of rainfall as wastewater or overflowing the holding tank due to rain events.

#### **6-14.10 Aircraft Wash Equipment.**

##### **6-14.10.1 Storage and Mixing Capability for Aircraft Cleaning Compounds.**

Generally, bulk storage tanks are recommended for high use wash facilities for dispensing the soap solutions onto the aircraft. These tanks are used in conjunction with cleaning compounds and equipment capable of mixing the detergents with water in the proper dilution ratios. However, in situations where relatively small quantities of cleaning compounds are expected to be used (i.e. at bases with a limited number of small aircraft), it may be appropriate to omit bulk storage capability from the facility design and incorporate storage space and handling capability for 55-gallon barrels.

##### **6-14.10.2 Pressurized Cleaning Dispensing and Rinse Water Systems.**

Pressurized dispensing systems will be used for the application of diluted cleaning compounds and rinse water generally and provide reductions in man-hours expended and quantities of water and cleaning materials used.

Refer to service specific guidance for recommendations or limitations on pressures and temperatures for pressurized cleaning systems.

#### **6-14.11 Safety and Health.**

##### **6-14.11.1 Eyewash Units and Emergency Showers.**

- Emergency shower and eyewash units must be provided in areas where harmful materials may be splashed into the eyes or on parts of the body. Follow UFC 3-420-01 Appendix D for guidance on design and installation of Eyewash Units and Emergency Showers. Also see AFOSHSTD 91-17 and ANSI Z358.1 for additional information.
- Emergency shower and eyewash units must be located in accessible locations that require no more than 10 seconds to reach and must be within 100 feet of the harmful substance
- Permanently installed units and self-contained units installed in fixed locations must be identified with a highly visible sign. The area around or behind the unit, or both, may be painted with green and white stripes if needed to increase visibility. If highlighted, the painted area will be large enough to be easily identified by the user.
- Emergency units must be well lighted. Where practical, a minimum of 50-foot candles of illumination must be provided.
- Units will be connected to a supply of water that is free from contamination and equal in purity to potable water.

##### **6-14.11.2 Fall Protection.**

Adequate fall protection is required in most newly constructed aircraft wash facilities. Primarily, personnel should avoid walking on wet surfaces to the greatest extent possible and utilize separate elevated work platforms and long-handle brushes to the maximum extent possible. However, experience has shown that it is impossible to adequately access most upper surfaces of large aircraft by these means. Therefore, personnel often must walk on aircraft wings or other surfaces during washing operations, which creates the possibility that they may fall 4 feet or more. In these situations, fall arrest or fall restraint systems are mandatory. Experience has shown that systems which utilize a lifeline, to which safety harnesses can be attached, are the most effective means of accessing upper surfaces of the aircraft during aircraft wash operations. Refer to AFOSHSTD 91-100, EM 385-1-1, Section 5, Personal Protective and Safety Equipment, and Section 21, Safe Access and Fall Protection, and AFOSHSTD 91-501 for complete guidance on fall protection requirements.

Due to the significant impact loads that the lifeline and anchor points impart to the building structure, attention must be given to installation of the fall restraint system in the earliest stages of facility design so that the loads are included in the design of the building's structural components. See UFC 4-211-02, *Aircraft Corrosion Control and Paint Facilities*, Paragraph 3-8.2 for a detailed description of fall protection systems and design requirements.

### **6-14.11.3 Personal Amenities.**

In remote areas, where personal amenities must be provided to support the installed Wash Rack, these amenities must conform to the General Construction section of this guide and EM 385-1-1, Section 2, Safety and Health Requirements- Sanitation.

### **6-14.12 Aircraft Rinse Facilities – Birdbaths.**

An Aircraft Rinse Facility referred to as a "Birdbath" provides an unattended taxi-through treadle operated freshwater deluge system to rinse aircraft typically subjected to accelerated corrosion due to low-level over water operations or a corrosive atmosphere at the installation.

See UFC 2-000-05N Section 116 15 for information concerning the requirements for a typical Birdbath. The following requirements and associated Figure 6-41 are for a Type "F" size aircraft (ref. Fig. 6-36). The information presented may be used as a guide and modified as appropriate for the configuration of the specific aircraft. If the aircraft manufacturer has recommended guidelines for a specific aircraft, the wash facility must be designed and constructed in accordance with the manufacturer's recommendations.

#### **Aircraft Rinse Facility – Requirements**

- a) Constant water pressure of 100 to 150 pounds per square inch (690 to 1034 kPA). A booster pump and storage tank must be provided to maintain specified quantity and pressure of water. Provide backflow prevention or an air gap.
- b) Provide drainage into sanitary sewer at an acceptable flowrate to prevent overloading downstream pump stations or the treatment facility. Verify with Base Environmental if an oil water separator is required. Provide diversion for rain events to prevent overloading the sewer and treatment plant with non-process water.
- c) Pavement must be Portland cement concrete designed to the same criteria as the aircraft wash rack. If aircraft exhaust will be directed directly at pavement for extended periods of time, give consideration to using high temperature concrete to mitigate damage that may be caused by hot exhaust.
- d) Each nozzle must have adjustable tips that can be adjusted with a swivel mount.
- e) Three nozzle types: A; B; and C

- Type A – (12) Used on the outriggers and in the edge of pavement trench. 50 gallons per minute (0.19 m<sup>3</sup>/minute) flow, solid stream. Tip set at 55 degrees F (12.8 degrees C).
  - Type B – (12) Used in the fifth trench from the centerline on both sides. 10 to 12 gallons per minute (0.04 to 0.05 m<sup>3</sup>/minute) flow, 15 degree flat spray. Tip set at 55 degrees F (12.8 degrees C).
  - Type C – (48) Used in the inside four trenches on both sides. 10 to 12 gallons per minute (0.04 to 0.05 m<sup>3</sup>/minute) flow, 30 degree flat spray.
- f) All nozzles are to be trenched with the exception of the outriggers. Each trench is to be covered with steel plate that has slots providing for the nozzle and water spray. The outriggers are elevated 1 foot off of the ground.
- g) Include freeze protection in areas prone to freezing.
- h) Include “soft-start” pump to prevent damage to the system when energized.

Figure 6-41. Aircraft Rinse Facility (Birdbath)

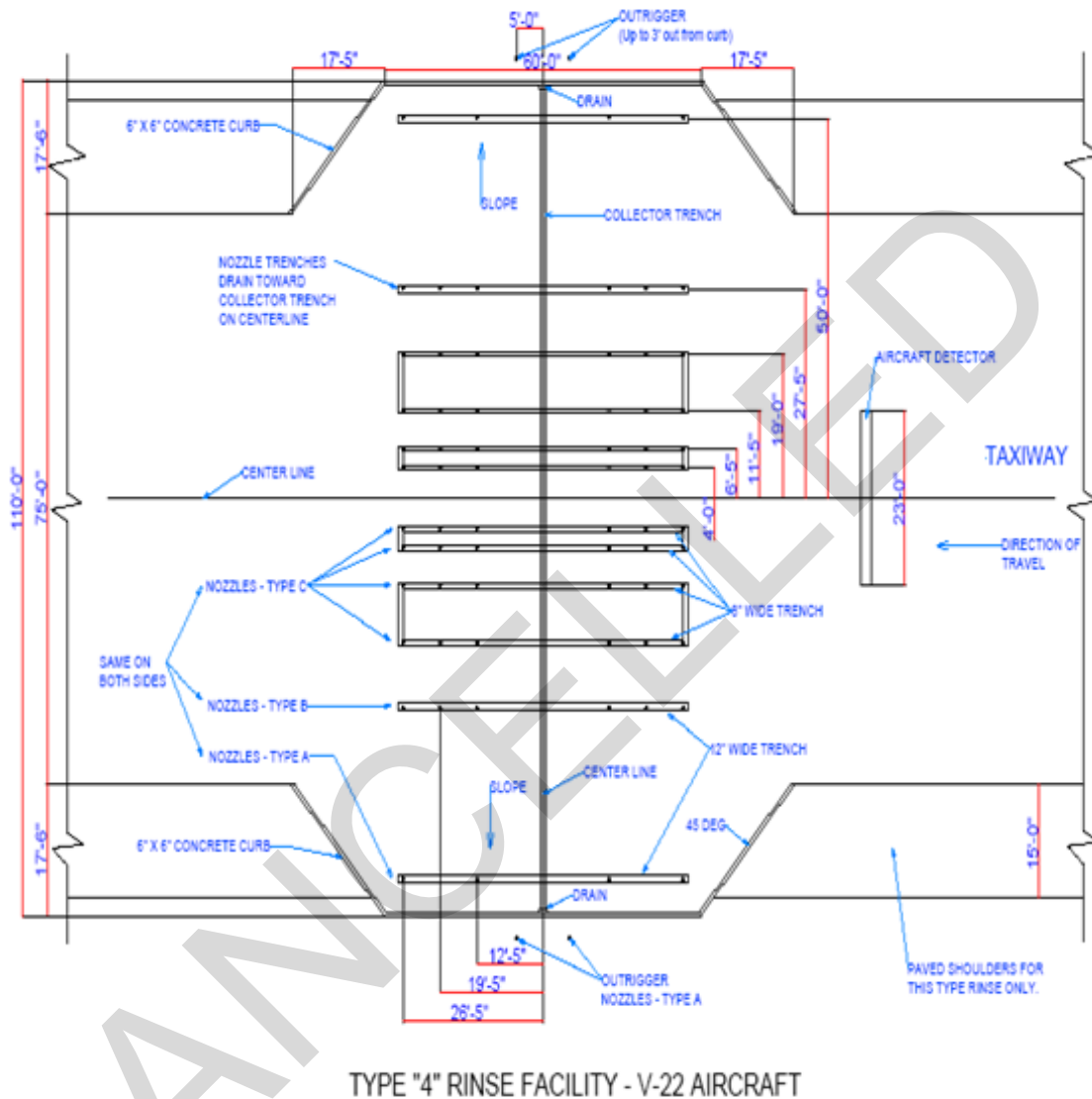

**6-15 HANGAR ACCESS APRONS.**

Hangar access aprons provide access to the hangars from the parking apron and allow free movement of aircraft to the various hangar maintenance facilities. Hangar access aprons should be provided as a supporting item for each authorized hangar and should be sized for the type of hangar and aircraft to be accommodated.

**6-15.1 Dimensions.**

Generally, hangar access aprons should be as wide as the hangar doors and extend from the edge of the apron to the hangar door. Hangar access apron dimension requirements are summarized in Table 6-6.

**6-15.2 Grades for Aircraft Fueling Ramps.**

Grades for hangar access ramps on which aircraft fueling will occur must slope away from aircraft hangars in accordance with NFPA Standard 415.

**6-15.3 Grades for Aircraft Access into Hangars.**

The grades in front of the hangar must allow access into the hangar. When aircraft are backed into the hangar, a tug vehicle pushes the aircraft in, tail first. Due to the location of the aircraft gear and the slope of the hangar access apron, the tail of the aircraft may be higher than the top of the hangar door. The hangar access apron grades may require adjustment to allow the aircraft tail to clear the hangar door.

**Table 6-6. Hangar Access Apron**

Table 6-6. Hangar Access Apron				
Item		Class A Runway	Class B Runway	Remarks
No.	Description	Requirement	Requirement	
1	Length	30 m (100 ft)	40 m (125 ft)	Army facilities for fixed-wing aircraft
		Distance to adjoining operational pavement		Air Force facilities for fixed-wing aircraft. <b>NOTE:</b> If the distance from the main operational pavement to the hangar exceeds the apron clearance distance (see Table 6-1, item 15), consider constructing a maneuvering area immediately outside the hangar, large enough to allow turning the aircraft around. The width of the maneuvering area should be equal to the width of the hangar door opening. Connect this maneuvering area to the main apron with a taxiway or towway.
		23 m (75 ft)		Army facilities for rotary-wing aircraft, except as noted below.
		30 m (100 ft)		Air Force facilities for rotary-wing aircraft, except as noted below Includes additional 50ft vehicular buffer required in front of hangars.
		15 m (50 ft)		Navy and Marine Corps facilities for fixed- and rotary-wing aircraft
		See Remarks		Access aprons are located between the apron and the front of the hangar. The hangar cannot be located within the apron clearance distance.

Table 6-6. Hangar Access Apron				
Item		Class A Runway	Class B Runway	Remarks
No.	Description	Requirement	Requirement	
2	Width	At least as wide as the hangar door width		Pavement should be sized for type of aircraft, number of hangar bays, and location of hangar bays.
3	Grades in direction of drainage	Min $\pm 0.5\%$ Max $\pm 1.5\%$		Avoid grades that prevent aircraft tails from clearing hangar doors.
		Min $-1.0\%$ first 15 m (50 ft) from hangar		NFPA 415 requires aircraft fueling ramps to slope away from terminal buildings, aircraft hangars, aircraft loading walkways, or other structures.
4	Width of shoulders (total width including paved and unpaved)	7.5 m (25 ft)		
5	Width of paved shoulders	Not required		
6	Sight distance	N/A (See note 1.)		
7	Transverse grade of unpaved shoulder	(a) 40 mm (1.5 in) drop-off at edge of pavement. (b) 2.0% min, 4.0% max.		
8	Wingtip clearance to fixed or mobile obstacles	7.6 m (25 ft)		Along length of access apron. Wingtip clearance at entrance to hangar may be reduced to 3.05 m (10 ft).
9	Grade (area between access apron shoulder and wingtip clearance line)	Max 10.0% (See note 2.)		If the wingtip clearance line falls within the access apron shoulder, no grading is required beyond the access apron shoulder.

**NOTES:**

1. N/A = not applicable
2. Bed of channel may be flat.
3. Metric units apply to new airfield construction and, where practical, modification to existing airfields and heliports, as discussed in paragraph 1-3.4.
4. The criteria in this manual are based on aircraft specific requirements and are not direct conversions from inch-pound (English) dimensions. Inch-pound units are included only as a reference to the previous standard.
5. Airfield and heliport imaginary surfaces and safe wingtip clearance dimensions are shown as a direct conversion from inch-pound to SI units.

**6-16 TAXIING CHARACTERISTICS ON APRONS FOR ROTARY-WING AIRCRAFT.**



Taxi routes across parking aprons are marked to provide safe passage of the aircraft across the apron. A hoverlane is a designated aerial traffic lane used exclusively for the movement of helicopters. A taxilane is a designated ground traffic lane.

#### **6-16.1 Hoverlane/Taxilane Width at Army Facilities.**

At Army Facilities, the hoverlane/taxilane widths are fixed distances based on type of aircraft, as noted in Table 6-2.

#### **6-16.2 Hoverlane/Taxilane Width at Air Force Facilities.**

At Air Force facilities, the hoverlane/taxilane width is based on the rotor diameter of the largest helicopter generally using the apron.

### **6-17 FIXED-WING AND ROTARY-WING GRADING STANDARDS.**

#### **6-17.1 Fixed-Wing Aircraft.**

Grading standards for fixed-wing parking aprons and shoulders are presented in Table 6-1. All parking aprons, pads, and miscellaneous pavements should follow these grading standards unless a particular mission requirement, such as a power check pad, dictates otherwise. Surface drainage patterns with numerous or abrupt grade changes can produce excessive pavement flexing and structural damage of aircraft and therefore should be avoided.

#### **6-17.2 Rotary-Wing Aircraft.**

Grading standards for rotary-wing parking aprons are presented in Table 6-2 for Army facilities. Air Force activities should use the grading criteria for the Army presented in this UFC for all rotary-wing aircraft except CH-53 and CH-54. For those aircraft, see the Mission Design Series Facility Requirements Documents.

#### **6-17.3 Grades for Aircraft Fueling Ramps.**

Grades for ramps on which aircraft fueling will occur should be in accordance with NFPA Standard 415.

### **6-18 SHOULDERS.**

Paved shoulders are provided around the perimeter of an apron to protect against jet blast and FOD, to support blast deflectors, for support equipment storage, to provide paved access to fire hydrants, and to facilitate drainage. Criteria for apron shoulders are presented in Table 6-1 for fixed-wing aprons, Table 6-2 for Army rotary-wing aprons, and AFMAN 32-1084 for Air Force rotary-wing facilities. To prevent storm water from ponding on the outside edge of the shoulder, the turf adjacent to the paved shoulder should be graded to facilitate drainage. See Paragraph 2-12 for requirements for designing buried utility structures in shoulders.

## **6-19 MISCELLANEOUS APRON DESIGN CONSIDERATIONS.**

In addition to the apron design criteria, consider providing room for support structures, equipment (e.g., aerospace ground equipment, hydrant refueling systems), and facilities.

### **6-19.1 Jet Blast Deflectors.**

Jet blast deflectors will substantially reduce the damaging effects of jet blast on structures, equipment, and personnel, as well as the related noise and fumes associated with jet engine operation. Additional information on jet blast deflectors is provided in Appendix B, Section 8.

### **6-19.2 Line Vehicle Parking.**

Vehicle parking areas are provided for parking mobile station-assigned and squadron-assigned vehicles and equipment (e.g., aerospace ground equipment). Additional information on line vehicle parking is located in Appendix B, Section 12.

### **6-19.3 Utilities.**

The items listed here are normally found on parking aprons. These items are not a part of airfield geometric design; however, the designer needs to be aware that they are an integral part of a parking apron and should make provisions for them accordingly.

- Storm water runoff collection system, including inlets, trench drains, manholes, and pipe
- De-icing facilities and de-icing runoff collection facilities
- Apron illumination
- Fire hydrants
- Refueling facilities
- Apron edge lighting

## **6-20 V-22 APRON CLEARANCES.**

Figure 6-42 provides parking block dimensions as well as peripheral and interior taxiway clearance requirements. The V-22 Parking Block will not overhang the apron shoulder.

## **6-21 US NAVY AND MARINE CORPS AIRCRAFT BLOCK DIMENSIONS.**

Figures 6-43 and 6-44 and Tables 6-7 through 6-10 provide Navy/Marine Corps aircraft parking apron criteria. The source of this information is UFC 2-000-05N and provided here for convenience. See source document for additional apron requirements.

Figure 6-42. V-22 Apron Clearance Requirements

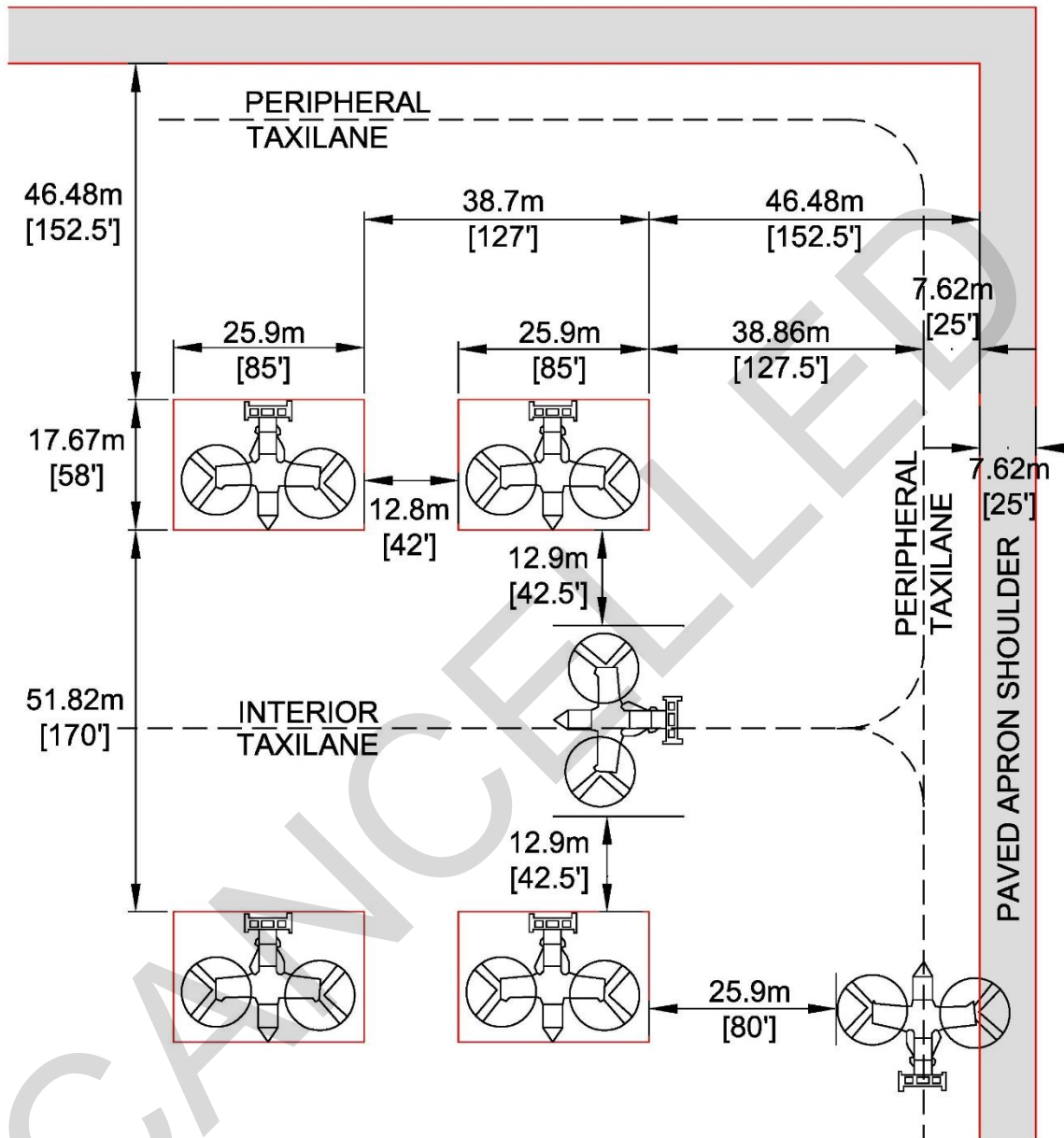

## NORMAL PARKING ARRANGEMENT

NOT TO SCALE

NOTE: FOR NAVY ONLY - WHERE 7.6m [25'] PAVED SHOULDER IS NOT PROVIDED AROUND APRON, MOVE PERIPHERAL TAXILANE CENTERLINE TO 12.9m [42.5'] FROM APRON EDGE.

Figure 6-43. Navy/Marine Corps, 90-Degree Aircraft Parking Configuration

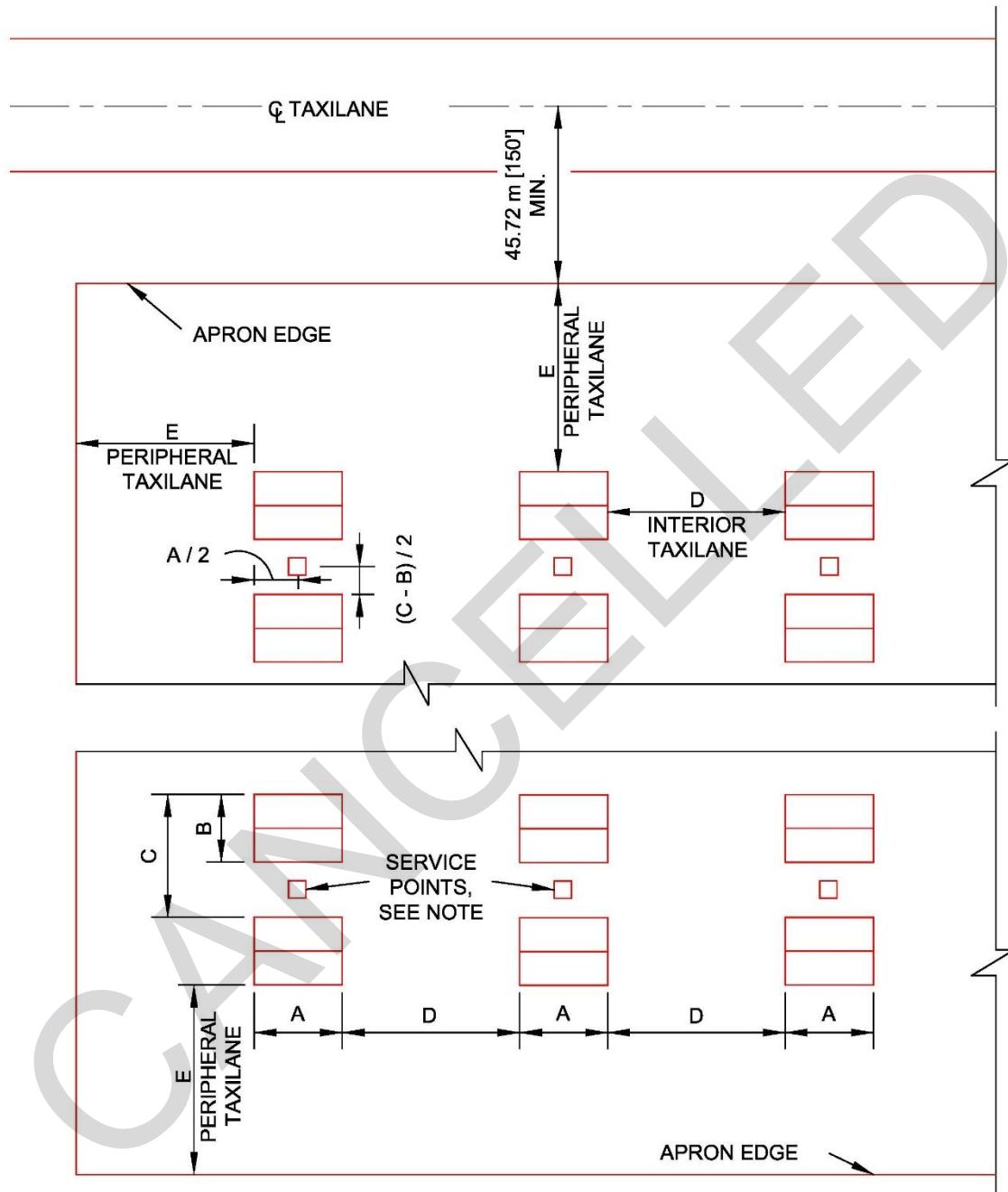

90° PARKING

NOTES

1. FOR DIMENSIONS A, B, C, D AND E SEE NAVY AIRCRAFT PARKING CONFIGURATION TABLES.
2. PARKED AIRCRAFT SHALL NOT PENETRATE 7:1 TRANSITIONAL SURFACE.

**Table 6-7. Navy/Marine Corps Aircraft Parking Spacing,  
Helicopter Aircraft, 90-Degree Parking**

Table 6-7. Navy/Marine Corps Aircraft Parking Spacing, Helicopter Aircraft, 90° Parking							
Aircraft Type	Wingspan m (ft/in)	Length m (ft/in)	A m (ft/in)	B m (ft/in)	C m (ft/in)	D m (ft/in)	E m (ft/in)
H-46	15.24 m (50 ft 0 in)	25.7 m (84 ft 4 in)	25.6 m (84 ft 0 in)	15.24 m (50 ft-0 in)	22.86 m (75 ft 0 in)	30.48 m (100 ft 0 in)	28.96 m (95 ft 0 in)
H-53D	22.02 m (72 ft 3 in)	26.9 m (88 ft 3 in)	26.82 m (88 ft 0 in)	21.95 m (72 ft 0 in)	32.92 m (108 ft 0 in)	43.89 m (144 ft 0 in)	39.01 m (128 ft 0 in)
H-53E	24.08 m (79 ft 0 in)	30.18 m (99 ft 0 in)	30.17 m (99 ft 0 in)	24.08 m (79 ft 0 in)	36.27 m (119 ft 0 in)	48.16 m (158 ft 0 in)	42.37 m (139 ft 0 in)
H-60	16.36 m (53 ft 8 in)	19.76 m (64 ft 10 in)	19.81 m (65 ft 0 in)	16.46 m (54 ft 0 in)	24.69 m (81 ft 0 in)	32.92 m (108 ft 0 in)	30.78 m (101 ft 0 in)

**Table 6-8. Navy/Marine Corps Aircraft Parking Spacing,  
Propeller Aircraft, 90-Degree Parking**

Table 6-8. Navy/Marine Corps Aircraft Parking Spacing, Propeller Aircraft, 90° Parking							
Aircraft Type	Wingspan m (ft/in)	Length m (ft/in)	A m (ft/in)	B m (ft/in)	C m (ft/in)	D m (ft/in)	E m (ft/in)
E-2	24.56 m (80 ft 7 in)	17.17 (56 ft 4 in)	17.07 m (56 ft 0 in)	24.69 m (81 ft-0 in)	30.78 m (101 ft 0 in)	36.88 m (121 ft 0 in)	45.72 m (150 ft 0 in)
P-3	30.38 m (99 ft 8 in)	35.61 m (116 ft 10 in)	35.66 m (117 ft 0 in)	30.48 m (100 ft 0 in)	36.58 m (120 ft 0 in)	42.67 m (140 ft 0 in)	45.72 m (150 ft 0 in)
OV-10	12.19 m (40 ft 0 in)	12.67 m (41 ft 7 in)	12.80 m (42 ft 0 in)	12.19 m (40 ft 0 in)	15.24 m (50 ft-0 in)	27.43 m (90 ft 0 in)	45.72 m (150 ft 0 in)
KC-130	40.40 m (132 ft 7 in)	29.82 m (97 ft 10 in)	29.87 m (98 ft 0 in)	40.54 m (133 ft 0 in)	48.16 m (158 ft 0 in)	55.78 m (183 ft 0 in)	45.72 m (150 ft 0 in)
T-28	12.37 m (40 ft 7 in)	10.52 m (34 ft 6 in)	10.67 m (35 ft 0 in)	12.50 m (41 ft 0 in)	15.54 m (51 ft 0 in)	27.43 m (90 ft 0 in)	45.72 m (150 ft 0 in)
T-34	10.16 m (33 ft 4 in)	8.76 m (28 ft 9 in)	8.84 m (29 ft 0 in)	10.06 m (33 ft 0 in)	13.11 m (43 ft 0 in)	27.43 m (90 ft 0 in)	45.72 m (150 ft 0 in)

<b>Table 6-8. Navy/Marine Corps Aircraft Parking Spacing, Propeller Aircraft, 90° Parking</b>							
<b>Aircraft Type</b>	<b>Wingspan m (ft/in)</b>	<b>Length m (ft/in)</b>	<b>A m (ft/in)</b>	<b>B m (ft/in)</b>	<b>C m (ft/in)</b>	<b>D m (ft/in)</b>	<b>E m (ft/in)</b>
T-44	15.32 m (50 ft 3 in)	10.82 m (35 ft 6 in)	10.97 m (36 ft 0 in)	15.24 m (50 ft 0 in)	19.81 m (65 ft 0 in)	27.43 m (90 ft 0 in)	45.72 m (150 ft 0 in)
V-22	25.81 m (84 ft 8 in)	17.48 m (57 ft 4 in)	17.67 m (58 ft 0 in)	25.91 m (85 ft 0 in)	38.71 m (127 ft 0 in)	51.82 m (170 ft 0 in)	46.48 m (152 ft 6 in)

**Table 6-9. Navy/Marine Corps Aircraft Parking Spacing,  
Jet Aircraft, 90-Degree Parking**

<b>Table 6-9. Navy/Marine Corps Aircraft Parking Spacing, Jet Aircraft, 90° Parking</b>							
<b>Aircraft Type</b>	<b>Wingspan m (ft/in)</b>	<b>Length m (ft/in)</b>	<b>A m (ft/in)</b>	<b>B m (ft/in)</b>	<b>C m (ft/in)</b>	<b>D m (ft/in)</b>	<b>E m (ft/in)</b>
F/A-18	12.32 m (40 ft 5 in)	17.07 m (56 ft 0 in)	17.07 m (56 ft 0 in)	12.19 m (40 ft 0 in)	15.24 m (50 ft 0 in)	35.05 m (115 ft 0 in)	45.72 m (150 ft 0 in)
F/A-18 E/F	13.64 m (44 ft 9 in)	18.34 m (60 ft 2 in)	18.59 m (61 ft 0 in)	13.72 m (45 ft 0 in)	16.76 m (55 ft 0 in)	38.4 m (126 ft 0 in)	45.72 m (150 ft 0 in)
AV-8A	7.62 m (25 ft 0 in)	13.72 m (45 ft 0 in)	13.72 m (45 ft 0 in)	7.62 m (25 ft 0 in)	10.67 m (35 ft 0 in)	30.48 m (100 ft 0 in)	45.72 m (150 ft 0 in)
AV-8B	9.25 m (30 ft 4 in)	16.23 m (53 ft 3 in)	14.02 m (46 ft 0 in)	9.14 m (30 ft 0 in)	12.19 m (40 ft 0 in)	30.48 m (100 ft 0 in)	45.72 m (150 ft 0 in)
S-3	20.92 m (68 ft 8 in)	16.23 m (53 ft 3 in)	16.15 m (53 ft 0 in)	21.03 m (69 ft 0 in)	25.6 m (84 ft 0 in)	38.1 m (125 ft 0 in)	45.72 m (150 ft 0 in)
C-5	67.89 m (222 ft 9 in)	74.96 m (245 ft 11 in)	74.98 m (246 ft 0 in)	67.97 m (223 ft 0 in)	75.59 m (248 ft 0 in)	83.21 m (273 ft 0 in)	45.72 m (150 ft 0 in)
C-9	28.45 m (93 ft 4 in)	36.37 m (119 ft 4 in)	36.27 m (119 ft 0 in)	28.35 m (93 ft 0 in)	34.44 m (113 ft 0 in)	40.54 m (133 ft 0 in)	45.72 m (150 ft 0 in)
KC-135	39.88 m (130 ft 10 in)	41.53 m (136 ft 3 in)	41.45 m (136 ft 0 in)	39.92 m (131 ft 0 in)	47.54 m (156 ft 0 in)	55.17 m (181 ft 0 in)	45.72 m (150 ft 0 in)

Table 6-9. Navy/Marine Corps Aircraft Parking Spacing, Jet Aircraft, 90° Parking							
Aircraft Type	Wingspan m (ft/in)	Length m (ft/in)	A m (ft/in)	B m (ft/in)	C m (ft/in)	D m (ft/in)	E m (ft/in)
T-2	11.56 m (37 ft 11 in)	11.81 m (38 ft 9 in)	11.89 m (39 ft 0 in)	11.58 m (38 ft 0 in)	14.63 m (48 ft 0 in)	33.53 m (110 ft 0 in)	45.72 m (150 ft 0 in)
T-39	13.54 m (44 ft 5 in)	13.41 m (44 ft 0 in)	13.72 m (45 ft 0 in)	13.41 m (44 ft 0 in)	16.46 m (54 ft 0 in)	35.05 m (115 ft 0 in)	45.72 m (150 ft 0 in)
T-45	9.7 m (31 ft 10 in)	11.96 m (39 ft 3 in)	11.89 m (39 ft 0 in)	9.45 m (31 ft 0 in)	12.5 m (41 ft 0 in)	30.48 m (100 ft 0 in)	45.72 m (150 ft 0 in)
F-35 B	10.7 m (35 ft 0 in)	15.6 m (51 ft 3 in)	13.7 m (45 ft 0 in)	13.7 m (45 ft 0 in)	19.8 m (65 ft 0 in)	61.0 m (200 ft 0 in)	45.7 m (150 ft 0 in)
F-35 C	13.1 m (43 ft 0 in)	15.6 m (51 ft 4 in)	14.3 m (47 ft 0 in)	14.3 m (47 ft 0 in)	19.8 m (65 ft 0 in)	61.0 m (200 ft 0 in)	45.7 m (150 ft 0 in)

\* Information not available

Figure 6-44. Navy/Marine Corps, 45-Degree Aircraft Parking Configuration

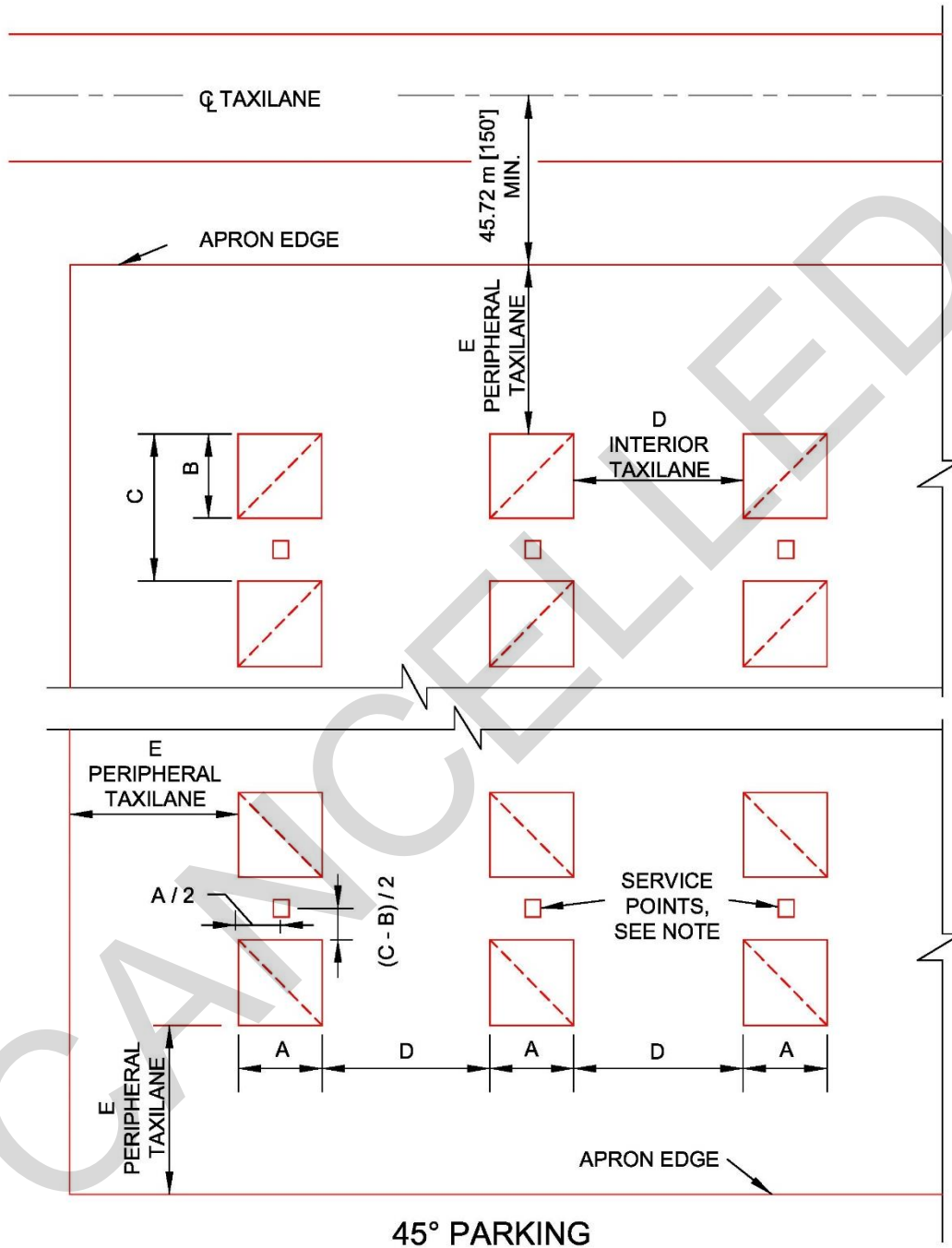

NOTES

1. FOR DIMENSIONS A, B, C, D AND E SEE NAVY AIRCRAFT PARKING CONFIGURATION TABLES.
2. PARKED AIRCRAFT SHALL NOT PENETRATE 7:1 TRANSITIONAL SURFACE.



**Table 6-10. Navy/Marine Corps Aircraft Parking Spacing,  
Jet Aircraft, 45-Degree Parking**

Table 6-10. Navy/Marine Corps Aircraft Parking Spacing, Jet Aircraft, 45° Parking							
Aircraft Type	Wingspan m (ft/in)	Length m (ft/in)	A m (ft/in)	B m (ft/in)	C m (ft/in)	D m (ft/in)	E m (ft/in)
F/A-18	12.32 m (40 ft 5 in)	17.07 m (56 ft 0 in)	14.33 m (47 ft 0 in)	14.33 m (47 ft 0 in)	21.64 m (71 ft 0 in)	27.43 m (90 ft 0 in)	45.72 m (150 ft 0 in)
F/A-18 E/F	13.64 m (44 ft 9 in)	18.34 m (60 ft 2 in)	15.54 m (51 ft 0 in)	15.54 m (51 ft 0 in)	23.77 m (78 ft 0 in)	27.43 m (90 ft 0 in)	45.72 m (150 ft 0 in)
AV-8A	7.62 m (25 ft 0 in)	13.72 m (45 ft 0 in)	9.75 m (32 ft 0 in)	9.75 m (32 ft 0 in)	17.37 m (57 ft 0 in)	27.43 m (90 ft 0 in)	45.72 m (150 ft 0 in)
AV-8B	9.25 m (30 ft 4 in)	16.23 m (53 ft 3 in)	10.97 m (36 ft 0 in)	10.97 m (36 ft 0 in)	17.37 m (57 ft 0 in)	27.43 m (90 ft 0 in)	45.72 m (150 ft 0 in)
S-3	20.92 m (68 ft 8 in)	16.23 m (53 ft 3 in)	15.54 m (51 ft 0 in)	15.54 m (51 ft 0 in)	34.75 m (114 ft 0 in)	30.18 m (99 ft 0 in)	45.72 m (150 ft 0 in)
C-5	67.89 m (222 ft 9 in)	74.96 m (245 ft 11 in)	60.66 m (199 ft 0 in)	60.66 m (199 ft 0 in)	106.68 m (350 ft 0 in)	83.21 m (273 ft 0 in)	45.72 m (150 ft 0 in)
C-9	28.45 m (93 ft 4 in)	36.37 m (119 ft 4 in)	29.57 m (97 ft 0 in)	29.57 m (97 ft 0 in)	48.77 m (160 ft 0 in)	40.54 m (133 ft 0 in)	45.72 m (150 ft 0 in)
KC-135	39.88 m (130 ft 10 in)	41.68 m (136 ft 3 in)	39.62 m (130 ft 0 in)	39.62 m (130 ft 0 in)	67.06 m (220 ft 0 in)	55.17 m (181 ft 0 in)	45.72 m (150 ft 0 in)
T-2	11.56 m (37 ft 11 in)	11.81 m (38 ft 9 in)	12.19 m (40 ft 0 in)	12.19 m (40 ft 0 in)	20.73 m (68 ft 0 in)	27.43 m (90 ft 0 in)	45.72 m (150 ft 0 in)
T-39	13.54 m (44 ft 5 in)	13.41 m (44 ft 0 in)	11.58 m (38 ft 0 in)	11.58 m (38 ft 0 in)	23.77 m (78 ft 0 in)	27.43 m (90 ft 0 in)	45.72 m (150 ft 0 in)
F-35 B	10.7 m (35 ft 0 in)	15.6 m (51 ft 3 in)	13.7 m (45 ft 0 in)	13.7 m (45 ft 0 in)	19.8 m (65 ft 0 in)	43.0 m (141 ft 0 in)	45.7 m (150 ft 0 in)
F-35 C	13.1 m (43 ft 0 in)	15.6 m (51 ft 4 in)	14.3 m (47 ft 0 in)	14.3 m (47 ft 0 in)	19.8 m (65 ft 0 in)	43.0 m (141 ft 0 in)	45.7 m (150 ft 0 in)

THIS PAGE INTENTIONALLY BLANK

CANCELLED

## CHAPTER 7 LANDING ZONES FOR C-130 AND C-17

### 7-1 GENERAL INFORMATION.

Landing zones (LZ) for C-130 and C-17 are special use airfields for aircrew training or contingency operations. This chapter provides guidance for planning, design, construction and evaluation of LZs. It includes criteria for the runway, taxiways, aprons, and airspace requirements, and addresses construction of non-airfield-related facilities near the airfield for both austere and built-up areas.

#### 7-1.1 Differences in Service Criteria.

Air Force, Army, Navy and Marine Corps have generally agreed to the same criteria, except where noted in the text, tables or figures.

#### 7-1.2 Landing Zone Marking and Lighting Standards.

This chapter currently includes LZ marking and lighting criteria. However, that criteria may get incorporated into other UFCs in the future.

#### 7-1.3 LZ Grade Evaluation.

The minimum transverse slopes for LZ runways, taxiways, aprons, shoulders, graded areas and maintained areas are intended for use during the construction and maintenance of the LZ to promote adequate drainage and prolong service life. When evaluating an existing LZ, if these areas are level or less than the minimum and the slope does not impact the suitability of the LZ for aircraft operations, a waiver is not required.

### 7-2 DEFINITIONS.

The terms in this section are defined only as they are used in this chapter.

#### 7-2.1 Accident Potential Zone–Landing Zone (APZ-LZ).

The land use control area beyond the clear zone of an LZ that possesses a significant potential for accidents; therefore, land use is a concern. See Figures 7-2 and 7-5.

#### 7-2.2 Clear Zone-LZ.

A surface on the ground or water, beginning at the runway threshold and symmetrical about the extended runway centerline, graded to protect aircraft operations and in which only properly sited NAVAIDs are allowed. See Figures 7-1, 7-2, and 7-5.

#### 7-2.3 Contingency Operations.

Typically, short-term operations conducted in support of conflicts or emergencies.

#### **7-2.4 Exclusion Area.**

Areas required for all paved and semi-prepared (unpaved) LZs. The purpose of the exclusion area is to restrict the development of facilities around the LZ. Only features required to operate the LZ or an adjacent airfield are permissible in the exclusion area, such as operational surfaces (e.g., runways, taxiways, and aprons), NAVAIDs, aircraft and support equipment, and cargo loading and unloading areas and equipment. Personnel formations, encampments, parked vehicles, storage areas, buildings, etc. are excluded from this area; roads, fences and trees are acceptable. In addition, only properly sited facilities are allowed in this area (see Appendix B, Section 13). The exclusion area extends the length of the runway, plus the clear zone on each end. See Figures 7-1, 7-2, and 7-5, and Table 7-8.

#### **7-2.5 Flashing Strobe Light (FSL).**

A flashing light used to mark the beginning or end of the usable runway surface when an LZ is used for night operations and configured in airfield marking pattern (AMP) -1 or AMP-3.

#### **7-2.6 Graded Area.**

An area beyond the runway shoulder where grades are controlled to prevent damage to aircraft that may depart the runway surface (see Figure 7-6 and Table 7-1). Graded areas will not have any obstacles over 75 millimeters (3 inches) high, except vegetation, visual landing zone marker panels (VLZMP), or other visual or electronic navigational aids which must be sited in this area due to their function. Culverts, headwalls, and elevated drainage structures are not allowed in this area. Properly sited, frangible NAVAIDs are allowed.

#### **7-2.7 Imaginary Surfaces-LZ.**

Surfaces in space established around an LZ in relation to runways, helipads, or helicopter runways, and designed to define the protected airspace around the airfield. The imaginary surfaces for LZs are the primary surface and approach-departure clearance surface. See Figures 7-1, 7-2, and 7-5, and Table 7-8. Minimum clearances over highways, railroads, waterways and trees are defined in Chapter 3, Table 3-8.

#### **7-2.8 Infield Area.**

The area between runways and between runways and taxiways that is graded or cleared for operational safety. All obstructions must be removed from the infield area.

#### **7-2.9 Landing Zone (LZ).**

Consists of a runway, a runway and taxiway, or other aircraft operational surfaces (e.g., aprons, turnarounds). It is a prepared or semi-prepared (unpaved) airfield used to conduct operations in an airfield environment similar to forward operating locations. LZ runways are typically shorter and narrower than standard runways. Because training

airfields are constructed for long-term operations, semi-prepared surface structural requirements are more stringent than those for contingency airfields.

**7-2.10      Overrun-LZ.**

An area the width of the runway, plus prepared shoulders, extending 91.5 meters (300 feet) from the end of the runway into the clear zone. This portion is an elongation of the runway and is constructed to support aircraft traffic. See Figure 7-1, and Table 7-5.

**7-2.11      Maintained Area.**

A land area, extending outward at right angles to the runway centerline and the extended runway centerline, that is outside the graded area but still within the exclusion area. This area must be free of obstructions. Culvert and culvert headwalls are permitted in the maintained area, provided headwalls are flush with the surrounding grade. The maintained area is 21.5 m (70 ft) wide for C-17 operations or 18.5 m (60 ft) wide for C-130 operations. The grade may slope up or down to provide drainage but may not exceed +10% nor -20% slope. See Figure 7-6 and Table 7-1.

**7-2.12      Parking Maximum on Ground (MOG).**

The highest number of aircraft that will be allowed on the ground at any given time based on airfield configuration limitations and safety considerations.

**7-2.13      Paved Landing Zone (LZ).**

A prepared and surfaced LZ designed to carry aircraft traffic. **NOTE:** Paved LZs were formerly called “shortfields” and later known as “prepared assault landing zones” (ALZ). The principal components of a paved LZ include one of the following:

- A flexible or non-rigid pavement, or one that includes a bituminous concrete surface course designed as a structural member with weather- and abrasion-resistant properties
- A rigid pavement, or one that contains PCC as an element
- A combination of flexible and rigid pavement layers, such as an overlay, where a flexible pavement is placed over an existing rigid pavement layer to strengthen the rigid pavement layer

**7-2.14      Primary Surface-LZ.**

An imaginary surface symmetrically centered on the LZ. The elevation of any point on the primary surface is the same as the elevation of the nearest point on the runway centerline or extended runway centerline. See Figures 7-1, 7-2, and 7-5 and Table 7-7, Item 1.

**7-2.15      Runway End.**

As used in this chapter, the runway end is where the normal threshold is located. When the runway has a displaced threshold, the responsible airfield authority will evaluate each individual situation and, based on this evaluation, will determine the point of beginning for runway and airspace imaginary surfaces. See Figure 7-1.

#### **7-2.16 Semi-Prepared Landing Zone (LZ).**

A semi-prepared LZ (formerly called a “semi-prepared ALZ”) refers to an unpaved LZ. The amount of engineering effort required to develop a semi-prepared LZ depends on the planned operation, the service life needed to support these operations, and the existing soil and weather conditions. Semi-prepared construction/maintenance preparations may range from those sufficient for limited use to those required for continuous, routine operations. Options for surface preparation may include stabilization, adding an aggregate course, compacting in-place soils, or matting.

#### **7-2.17 Turnaround (or Hammerhead).**

An operational surface with dimensions to allow an aircraft to execute 180-degree turns without using reverse operations. Turnarounds can provide loading/off-loading capability on LZs with a parking MOG of one. See Figure 7-3 and 7-11.

#### **7-2.18 Visual Landing Zone Marker Panels (VLZMP).**

Vertical, colored panels installed along runway edges to indicate the threshold location and distance remaining. See Figures 7-7, 7-8a, 7-8b, 7-12, 7-13, and 7-14.

### **7-3 SITE PLANNING FOR LANDING ZONES (LZ).**

When planning the layout of an LZ that will be used for extended operations (generally defined as more than one year), site conditions beyond the safety of the aircraft-related operations must be considered. These conditions include land use compatibility with clear zones, primary surfaces, exclusion areas, and approach-departure surfaces, and with existing and future use of the areas that surround the LZ. In planning an LZ, consider the use and zoning of surrounding land for compatibility with aircraft operations. The purpose is to protect the operational capability of the LZ and prevent incompatible development, thus minimizing health and safety concerns in areas subject to high noise and accident potential resulting from frequent aircraft overflights. The minimum criteria in this chapter establish standards for a safe environment for aircraft and ground operations. For long-term-use LZs, restricting use of available land beyond the minimum distances contained in this chapter is highly recommended. This will protect operational capability and enhance the potential for future mission expansion. Land use and zoning restrictions for training LZs must also comply with AFH 32-7084. The goal is to provide an LZ environment that provides the greatest margin of safety and compatibility for personnel, equipment, and facilities.

#### **7-3.1 Future Development (Land or Aircraft Technology).**

Adequate land for future aviation growth must be considered when planning an LZ. The LZ should be compatible with the existing installation plan. Potential instrument meteorological conditions/instrument flight rules (IMC/IFR) capability will require additional criteria considerations.

### **7-3.2 Prohibited Land Uses.**

LZ criteria prohibit certain land uses within the exclusion area, clear zone, and APZ. These restrictions are described in Tables 7-6, 7-7 and 7-8.

### **7-3.3 APZs not on DoD Property.**

APZs that are not on DoD property may require easements to control development and removal of vegetation that may violate the approach-departure clearance surface. The need must be determined on a case-by-case basis.

## **7-4 SITING CONSIDERATIONS.**

Site considerations include topography, vegetative cover, existing construction, weather elements, wind direction, soil conditions, flood hazard, natural and man-made obstructions, adjacent land use, availability of usable airspace, accessibility of roads and utilities, and potential for expansion. Also consider the effects of ambient lighting for operations with night vision goggles (NVG). The potential for encroachment and the effects of noise on the local community must also be considered.

### **7-4.1 Training Landing Zones (LZs).**

For training LZs, it is preferred to site the runway within an airfield environment to take advantage of existing runway and taxiway clearance areas. To maximize the training environment, avoid aligning LZ runways parallel to existing runways.

### **7-4.2 Siting Landing Zones (LZs).**

Siting of LZs must take into account noise levels on existing facilities.

### **7-4.3 FAA Requirements.**

When a new LZ is sited, in addition to local permitting requirements, file FAA Form 7480-1 in accordance with FAA Order 7400.2.

### **7-4.4 Siting LZs in Built-Up Areas.**

When siting a training LZ runway within an existing built-up and occupied area, use a 305-m-wide (1000-ft-wide) exclusion area rather than the 213.5-m (700-ft) exclusion area for LZs in unoccupied areas. The 305-m-wide (1,000-ft-wide) exclusion zone extends from clear zone end to clear zone end, centered on the runway centerline. In addition, the APZ-LZ is widened to 305 m (1,000 ft) wide. Built-up and occupied locations are defined as locations where occupied buildings/facilities exist around the

potential LZ site that are not related to the LZ mission. Unoccupied locations are where no buildings/facilities exist around the proposed LZ except those that are LZ mission-related. The same rules apply for siting future facilities near existing LZs. If the facility and occupants are not related to the LZ mission, then the wider exclusion zone and APZ-LZ apply.

**7-4.5 Siting LZs Superimposed on Class A or B Runways.**

When an LZ is marked on a Standard Class A or B runway, conduct and document a risk assessment to determine any risk associated with the operation or impact on current mission aircraft. This will include an evaluation of any existing waivers to UFC 3-260-01 that exist for current obstructions/non-compliant conditions and any portion of the LZ area that may have been built to a previous standard. New waivers will be needed for any non-compliant condition to the required LZ criteria. All non-compliant conditions will be identified and documented and any risk associated with these conditions will be coordinated with the aircraft unit using the LZ and approved by the responsible airfield authority.

**7-5 GEOMETRIC CRITERIA FOR RUNWAYS AND OVERRUNS.**

Tables 7-1 through 7-5 provide dimensional criteria for the layout and design of LZ runways, taxiways, aprons, and overruns.

**Table 7-1. Runways for LZs**

Table 7-1. Runways for LZs							
Item		Paved		Semi-Prepared (Unpaved)		Remarks	
No.	Description	C-130	C-17	C-130	C-17		
1	Length	Min. 914 m (3000 ft)	Min. 1067 m (3500 ft) See Remarks.	Min. 914 m (3000 ft)	Min. 1067 m (3500 ft) See Remarks.	See paragraph 7-5.1 and Table 7-2 for LZ length requirements for the C-17. For lengths less than 1067 m (3500 ft), a waiver from the responsible airfield authority is required prior to initiating flying operations (see paragraph 7-7).	
2	Width	18.5 m (60 ft)	27.5 m (90 ft)	18.5 m (60 ft)	27.5 m (90 ft)		See Note.
3	Width of shoulders	Min. 3 m (10 ft)					Remove all tree stumps and loose rocks in shoulder areas. Shoulders for paved LZs will be paved. Shoulders for semi-prepared LZs should be stabilized to prevent erosion by jet blast. Where adequate sod cover cannot be established, the shoulders should be chemically stabilized.



Table 7-1. Runways for LZs						
Item		Paved		Semi-Prepared (Unpaved)		Remarks
No.	Description	C-130	C-17	C-130	C-17	
4	Longitudinal grades of runway and shoulders	Max. 3% at any location on profile  C-17: Effective Gradient 2% Maximum				Hold to minimum practicable. Grades may be both positive and negative but must not exceed the limit specified. Effective Gradient = (Max LZ Centerline elevation – Min LZ Centerline elevation)/Total LZ Length.
5	Longitudinal runway grade change	Max. 1.5% per 61 m (200 ft)				Grade changes should be held to a minimum and should be gradual. Minimum distance between grade changes is 61 m (200 ft). Grade changes cannot exceed 1.5% measured at 61 m (200 ft) intervals.
6	Transverse grade of runway	0.5% Min. 3.0% Max.				Transverse grades should slope down from the runway centerline. The intent of the transverse grade limit is to provide adequate cross slope to facilitate drainage without adversely affecting aircraft operations.
7	Transverse grade of runway shoulders	1.5% Min. 5.0% Max.				Transverse grades should slope down from the runway edge. The intent of the transverse grade limit is to facilitate drainage.
8	Width of graded area	10.5 m (35 ft)				Cut trees flush with the ground. Remove or embed rocks such that no parts of rocks protrude more than 75 mm (3 in) above surrounding surface. Remove vegetation (excluding grass) to within 75 mm (3 in) of the ground. Jet blast may cause erosion of the graded area. For paved LZs where adequate vegetation cannot be established to prevent erosion, the graded area may be covered with a thin 38 mm to 51 mm (1.5 in. to 2.0 in) asphalt layer or with an engineered surface such as articulated concrete blocks or a stone bed (4" to 8" stones in 12" layer on geotextile fabric) spread and compacted to present an even surface with no protrusions or indentations more than 75 mm (3 inches). Open culverts, headwalls, and elevated

Table 7-1. Runways for LZs						
Item		Paved		Semi-Prepared (Unpaved)		Remarks
No.	Description	C-130	C-17	C-130	C-17	
						drainage structures are not allowed in this area.
9	Transverse grade of graded area	2.0% Min. 5.0% Max.				Grades may slope up or down, but may not penetrate the primary surface. Grade changes (including positive to negative) are permitted within the graded area.
10	Width of maintained area	18.5 m (60 ft)	21.5 m (70 ft)	18.5 m (60 ft)	21.5 m (70 ft)	Remove obstructions; cut trees flush with ground. Remove or embed rocks that protrude more than 75 mm (3 in) above grade. Remove vegetation (excluding grass) to within 150 mm (6 in) of the ground.
11	Maintained area: transverse grade	Maximum range: +10.0% to -20.0%				Grades may slope up or down to provide drainage, but may not exceed +10.0% nor -20.0% slope.
12	Runway-Taxiway Separation	81 m (265 ft)		93 m (305 ft)		

**NOTE:** For C-17 LZs without parallel taxiways, turnarounds must be provided at both ends of the runway. Turnarounds for C-17 aircraft should be 55 m (180 ft) long and 50.5 m (165 ft) wide (including the overrun/runway width), with 45-degree fillets. The aircraft must be positioned within 3 m (10 ft) of the runway edge prior to initiating this turn. If provided, turnarounds for C-130 aircraft should be at least 30 m (100 ft) in diameter.

### 7-5.1 LZ Runway Lengths.

Table 7-1 provides minimum runway lengths for C-130 LZs and Table 7-2 provides minimum runway lengths for C-17 LZs. Consult with flying group to determine runway length required to support the mission. For a C-17 LZ located between sea level and 915 m (3,000 ft) pressure altitude, the minimum length requirement for C-17 operations is 1067 m (3,500 ft) with 91.5-m (300-ft) overruns on each end. This length requirement, based on a runway condition reading (RCR) of 20, assumes an ambient temperature of 32.2 degrees Celsius (90 degrees Fahrenheit) and a landing gross weight of 202,756 kg (447,000 lb). Based on these same temperature and weight assumptions, the runway length will vary with different RCRs. Typically, paved surfaces will have RCRs of 23 dry, 12 wet, and 5 icy. Mat surfaces will have RCRs of 23 dry and 10 wet. A semi-prepared runway with stabilized soil surfaces will have RCRs of 20 dry and 10 wet. Unstabilized soil surfaces will have RCRs of 20 dry and 4 wet.

**Table 7-2. C-17 LZ Runway Lengths**

Table 7-2. C-17 LZ Runway Lengths		
202,756 kg (447,000 lb): NORMAL Max Weight for <i>Soil Surfaced LZs</i>		
RCR	Pressure Altitude, m (ft)	Runway Length, m (ft) *
20 (dry soil)	0 to 914 (3000)	1067 (3500)
	915 (3001) to 1829 (6000)	1219 (4000)
10 (wet soil)	0 to 609 (2000)	1524 (5000)
	610 (2001) to 1524 (5000)	1676 (5500)
	1525 (5001) to 1829 (6000)	1829 (6000)
220,446 kg (486,000 lb): INCREASED Max Weight for <i>Soil Surfaced LZs</i>		
RCR	Pressure Altitude, m (ft)	Runway Length, m (ft) *
20 (dry soil)	0 to 914 (3000)	1067 (3500)
	915 (3001) to 1219 (4000)	1219 (4000)
	1220 (4001) to 1524 (5000)	1372 (4500)
	1525 (5001) to 1829 (6000)	1524 (5000)
	1830 (6001) to 2134 (7000)	1676 (5500)
10 (wet soil)	0 to 609 (2000)	1676 (5500)
	610 (2001) to 914 (3000)	1829 (6000)
	915 (3001) to 1524 (5000)	1981 (6500)
	1525 (5001) to 1829 (6000)	2134 (7000)
227,703 kg (502,000 lb): Max Weight for Contingency Operations on <i>Paved LZs</i>		
RCR	Pressure Altitude, m (ft)	Runway Length, m (ft)
23 (dry pavement)	0 to 609 (2000)	1067 (3500)
	610 (2001) to 914 (3000)	1219 (4000)
	915 (3001) to 1219 (4000)	1372 (4500)
	1220 (4001) to 1524 (5000)	1524 (5000)
	1525 (5001) to 1829 (6000)	1676 (5500)
	1830 (6001) to 2134 (7000)	1829 (6000)
12 (wet pavement)	0 to 609 (2000)	1676 (5500)
	610 (2001) to 914 (3000)	1829 (6000)
	915 (3001) to 1524 (5000)	1981 (6500)
	1525 (5001) to 1829 (6000)	2134 (7000)
5 (icy pavement)	1830 (6001) to 2134 (7000)	2286 (7500)
	0 to 304 (1000)	2134 (7000)
	305 (1001) to 914 (3000)	2438 (8000)
	915 (3001) to 1219 (4000)	2591 (8500)
	1220 (4001) to 1524 (5000)	2744 (9000)
	1525 (5001) to 1829 (6000)	2897 (9500)
	1830 (6001) to 2134 (7000)	3048 (10000)

\*NOTE: Runway lengths **do not** include overruns.

### 7-5.2 LZ Runway Widths.

Table 7-1 provides the minimum width for LZ runways. The widths of these landing surfaces provide the minimum-width operating surface for the given aircraft.

### 7-5.3 Operating Surface Gradient Allowances.

Operational surface gradient constraints are based on reverse aircraft operations conducted on hard surfaces. See Tables 7-2, 7-3, 7-4, and 7-5 for specific allowances.

**7-5.4 LZ Shoulders.**

Shoulders are graded and cleared of obstacles and slope downward away from the operating surface, where practical, to facilitate drainage. See Tables 7-2, 7-3, 7-4, and 7-5.

**Table 7-3. Taxiways for LZs**

Table 7-3. Taxiways for LZs						
Item		Paved		Semi-Prepared (Unpaved)		Remarks
No.	Description	C-130	C-17	C-130	C-17	
1	Width	9 m (30 ft)	15.0 m (50 ft)	9 m (30 ft)	15.0 m (50 ft)	
2	Turning radii	21.5 m (70 ft)	27.5 m (90 ft) See Remarks.	21.5 m (70 ft)	27.5 m (90 ft) See Remarks.	C-17 aircraft can execute "star turns," which require forward and reverse taxi within 27.5 m (90 ft); however, for normal 180-degree turn maneuvers, the C-17 turn radius is 35.36 m (116 ft).
3	Shoulder width	3 m (10 ft)				Shoulders for paved LZs should be paved. Shoulders for semi-prepared LZs should be stabilized to prevent erosion by jet blast. Where adequate sod cover cannot be established, the shoulder should be chemically stabilized. Remove all tree stumps and loose rocks.
4	Longitudinal grade	Maximum 3.0%				Hold to minimum practicable. Grades may be both positive and negative.

Table 7-3. Taxiways for LZs						
Item		Paved		Semi-Prepared (Unpaved)		Remarks
No.	Description	C-130	C-17	C-130	C-17	
5	Rate of longitudinal grade change	Maximum 2.0% per 30 m (100 ft)				Grade changes should be held to a minimum and should be gradual. Minimum distance between grade changes is 30 m (100 ft). Grade changes cannot exceed 2.0% measured at 30 m (100 ft) intervals.
6	Transverse grade of taxiway	0.5% to 3.0%				Transverse grades should slope down from the taxiway centerline. The intent of the transverse grade limitation is to provide adequate cross slope to facilitate drainage without adversely affecting aircraft operations. The surfaces should slope so that the centerline of the taxiway is crowned.
7	Transverse grade of taxiway shoulder	1.5% to 5.0%				Transverse grades should slope down from the taxiway edge. The intent of the transverse grade limit is to facilitate drainage.
8	Runway-Taxiway Separation	81 m (265 ft)	93 m (305 ft)	81 m (265 ft)	93 m (305 ft)	Measured from the runway centerline to the taxiway centerline.
9	Infield area					All areas located between the runway and taxiways must be cleared of obstructions.
10	Clearance to fixed or mobile obstacles	29 m (95 ft)	33.5 m (110 ft)	29 m (95 ft)	33.5 m (110 ft)	Measured from the taxiway centerline. Required to provide minimum 7.5-m (25-ft) wingtip clearance.

Table 7-3. Taxiways for LZs						
Item		Paved		Semi-Prepared (Unpaved)		Remarks
No.	Description	C-130	C-17	C-130	C-17	
11	Taxiway clear area – width	21.5 m (70 ft) for C-130 22.9m (75 ft) for C-17				Measured from the outer edge of the taxiway shoulder to the obstacle clearance line. Remove or embed rocks that protrude more than 75 mm (3 in) above the surrounding surface. Cut tree stumps, brush, and other vegetation (excluding grass) to within 150 mm (6 in) of the ground.
12	Taxiway clear area – grade	Maximum range: +10.0% to -5.0%				Transverse grades may slope up or down to provide drainage but may not exceed a +10% nor -5% slope.
13	Taxiway Edge Safety Margin	2.1 m (7 ft)	2.1 m (7 ft)	2.1 m (7 ft)	2.1 m (7 ft)	Distance between outside of main gear and edge of full strength runway or taxiway.

Table 7-4. Aprons for LZs

Table 7-4. Aprons for LZs							
Item		Paved		Semi-Prepared (Unpaved)		Remarks	
No.	Description	C-130	C-17	C-130	C-17		
1	Apron size	See Remarks.			See Note.		Sized to accommodate mission. Maximum visibility must be maintained at all times. As a minimum, the pilot must be able to clearly see all parked aircraft when taxiing. On paved aprons, clearance between wing tips of parked aircraft will be minimum 7.5 m (25 ft). Clearance between wing tips of taxiing aircraft and parked aircraft will be minimum 7.5 m (25 ft) for paved aprons and 15 m (50 ft) for semi-prepared aprons.
2	Apron grades in the direction of drainage	1.5 to 3.0%					
3	Width of apron shoulder	3 m (10 ft)					Apron shoulders for paved LZs should be paved. Shoulders for semi-prepared LZs should be stabilized to prevent erosion by jet blast. Where adequate sod cover cannot be established, the shoulders should be chemically stabilized.
4	Transverse grade of shoulder away from the apron edge	1.5 to 5.0%					Apron shoulder should be graded to carry storm water away from the apron. In shoulder areas, remove all tree stumps and loose rocks.
5	Apron Parking Setback	58 m (190 ft)	65.5 m (215 ft)	58 m (190 ft)	65.5 m (215 ft)	Measured from the runway centerline to the setback line. Aprons may be contiguous with the runway, but parked aircraft and vehicles must be behind this line. See Figure 7-4.	
6	Clearance from edge of apron to fixed or mobile obstacles	26 m (85 ft)	30.5 m (100 ft)	26 m (85 ft)	30.5 m (100 ft)	Measured from the outer edge of the apron to obstacle clearance line. Remove or embed rocks that protrude more than 75 mm (3 in) above the surrounding surface. Cut tree stumps, brush, and other vegetation (excluding grass) to within 150 mm (6 in) of the ground.	

Item		Paved		Semi-Prepared (Unpaved)		Remarks
No.	Description	C-130	C-17	C-130	C-17	
7	Apron clear area grade	Maximum range: +10.0% to -5.0%				Grades may slope up or down to provide drainage, but may not exceed a +10% nor -5% slope. Centerline of drainage ditches must be established away from apron shoulders to prevent water from backing up onto the shoulder area.

**NOTE:** To eliminate the potential for FOD created by jet blast to parked and taxiing aircraft, individual parking aprons should be provided for each C-17 aircraft on semi-prepared LZs (other than AM-2 mat surfaced). Each apron should be a minimum of 61 m (200 ft) wide and 68.5 m (225 ft) long. Topography, mission, and obstructions determine the location and spacing between multiple aprons, but the aprons should not be located less than 152.5 m (500 ft) apart. All loose material must be stabilized or removed before the aprons can be operational.

Table 7-5. Overruns for LZs

Item		Paved		Semi-Prepared (Unpaved)		Remarks
No.	Description	C-130	C-17	C-130	C-17	
1	Overrun length	91.5 m (300 ft)				The overruns must be constructed to the same standards as the runway. Overruns for mat surfaced runways must also be mat.
2	Overrun width	18.5 m (60 ft)	27.5 m (90 ft)	18.5 m (60 ft)	27.5 m (90 ft)	
3	Longitudinal grade of overruns	Maximum 3%				After first 30.5m (100 ft), overrun will be 0.0% or downward to avoid penetrating the ADCS.
4	Longitudinal Overrun Grade Change	Max. 2.0% per 30.5 m (100 ft)				First 30.5 m (100 ft) of overrun grade must match runway grade. Vertical curve at grade transition is desirable, but not required. No more than one grade change is allowed within the overrun. For Training LZs, minimize grade changes within the overrun and always use vertical curves at transitions.
5	Transverse grade of overruns	0.5% min. 3.0% max.				Grades should slope downward from overrun centerline.



Table 7-5. Overruns for LZs						
Item		Paved		Semi-Prepared (Unpaved)		Remarks
No.	Description	C-130	C-17	C-130	C-17	
6	Width of overrun shoulder	3m (10 ft)				Overrun shoulders for paved LZs should be paved. Shoulders for semi-prepared LZs should be stabilized to prevent erosion by jet blast. Where adequate sod cover cannot be established, the shoulders should be chemically stabilized.
7	Transverse grade of overrun shoulders	1.5% min. 5.0% max.				Transverse grades should slope down from the overrun edge. The intent of the transverse grade limit is to facilitate drainage.

### 7-5.5 Turnarounds.

For C-17 LZs without parallel taxiways, turnarounds must be provided at both ends of the runway. In other cases, turnarounds may be located on overruns or taxiways, depending upon mission or terrain requirements. The shoulder, structural, gradient, and clearance requirements for a turnaround are the same as those for the overrun or taxiway area where the turnaround is constructed. Turnarounds for C-130 aircraft should be at least 30 m (100 ft) in diameter. Turnarounds for C-17 aircraft should be 55 m (180 ft) long and 50.5 m (165 ft) wide (including the overrun/taxiway width) with 45-degree fillets. The aircraft landing gear must be positioned within 3 m (10 ft) of the runway edge prior to initiating this turn.

### 7-6 IMAGINARY SURFACES AND LAND USE CONTROL AREAS.

Minimum requirements for APZ-LZs and Exclusion Areas, clear zones and imaginary surfaces must be established to provide a reasonable level of safety for LZs. These criteria are provided in Tables 7-6, 7-7, and 7-8, respectively. These areas and the imaginary surfaces are shown in Figures 7-1, 7-2, 7-5 and 7-6. Airfield airspace criteria prohibit certain land uses within the clear zone, APZ. These land uses include storage and handling of munitions and hazardous materials, and live fire weapons ranges. See DoDI 4165.57 for more information.

Table 7-6. Accident Potential Zones (APZs) and Exclusion Areas for LZs

Table 7-6. APZs and Exclusion Areas for LZs						
Item		Paved		Semi-Prepared (Unpaved)		Remarks
No.	Description	C-130	C-17	C-130	C-17	
1	APZ-LZ length	762 m (2,500 ft)				<p>Limit the following, where possible within the APZ-LZ:</p> <ul style="list-style-type: none"> <li>Actions that release any substances into the air that would impair visibility or otherwise interfere with operating aircraft, such as steam, dust, and smoke.</li> <li>Actions that produce electrical emissions that would interfere with aircraft and/or communications or navigational aid systems.</li> <li>Actions that produce light emissions, direct or indirect (reflective), that might interfere with pilot vision.</li> <li>Items that unnecessarily attract birds or waterfowl, such as sanitary landfills, feeding stations, or certain types of crops or vegetation.</li> <li>Explosive facilities or activities.</li> <li>Troop concentrations, such as housing areas, dining or medical facilities, and recreational fields that include spectators.</li> </ul>
2	APZ-LZ width	Unoccupied Area: 152.5 m (500 ft)		Occupied and Built-Up Area: 305 m (1,000 ft)		<p>For cases where a training LZ may be sited near permanently occupied facilities or where new facilities may be sited near an LZ, use a 305-m-wide (1,000-ft-wide) APZ-LZ. See section 7-5 for all necessary modifications and considerations.</p>

Table 7-6. APZs and Exclusion Areas for LZs						
Item		Paved		Semi-Prepared (Unpaved)		Remarks
No.	Description	C-130	C-17	C-130	C-17	
3	Exclusion area width	Unoccupied Area: 213.5 m (700 ft)  Occupied and Built-Up Area: 305 m (1,000 ft)  Navy/Marine Corps Permanent Training LZ: 305 m (1,000 ft)				<p>Exclusion areas are required for all paved and semi-prepared LZs. The purpose of the exclusion area is to restrict development of facilities around the LZ. Only features required to operate the LZ, such as operational surfaces (e.g., taxiways, aprons), NAVAIDs, airfield lights and signs, aircraft and support equipment, and cargo loading and unloading areas and equipment, are permissible in the exclusion area. Personnel formations, encampments, parked vehicles, storage areas, buildings, etc. are excluded from this area. Roads, fences and trees are acceptable. The exclusion area is centered on the runway. For long-term use LZs, restricting use of available land beyond the minimum distances contained in this UFC is highly recommended. The goal is to provide the greatest margin of safety for personnel, equipment, and facilities.</p> <p>For cases where a training LZ may be sited near permanently occupied facilities or where new facilities may be sited near an LZ, use a 304.8-m-wide (1,000-ft-wide) exclusion area. See paragraph 7-4.4 for a clarification of built-up and occupied areas.</p> <p>Navy/Marine Corps Permanent Training LZs: Treat the Exclusion Zone like the primary surface, which must be clear of all above-grade obstacles.</p>
4	Exclusion Area Length	Runway length + length of Clear Zones				See requirements in Item 3.

Table 7-7. Runway End Clear Zone for LZs

Table 7-7. Runway End Clear Zone for LZs						
Item		Paved		Semi-Prepared (Unpaved)		Remarks
No.	Description	C-130	C-17	C-130	C-17	
1	Length	152.5 m (500 ft)				Measured along the extended runway centerline; begins at the runway threshold.
2	Width at inner edge	82.5 m (270 ft)	98 m (320 ft)	82.5 (270 ft)	98 m (320 ft)	
3	Width at outer edge	152.5 m (500 ft)				
4	Longitudinal and transverse grade of surface	Maximum 5.0%				Grades are exclusive for clear zone and are not part of the overrun but are shaped into the overrun grade. Grades may slope up or down to provide drainage. Exception: Essential drainage ditches may be sloped up to 10% in the clear zones. Do not locate these ditches within 23 m (75 ft) of a C-130 runway centerline or within 27.5 m (90 ft) of a C-17 runway centerline. Such ditches should be essentially parallel with the runway. Remove or embed rocks that protrude more than 100 mm (4 in) above the surrounding grade. Cut tree stumps, brush, and other vegetation (excluding grass) to within 150 mm (6 in) of the ground.

CANCELLED

Table 7-8. Imaginary Surfaces for LZs

Table 7-8. Imaginary Surfaces for LZs						
Item		Paved		Semi-Prepared (Unpaved)		Remarks
No.	Description	C-130	C-17	C-130	C-17	
1	Primary surface length	Runway length plus 305 m (1,000 ft)				Centered on the runway (includes lengths of clear zones)
2	Primary surface width	45.5 m (150 ft)	55 m (180 ft)	45.5 m (150 ft)	55 m (180 ft)	Centered on the runway
3	Primary surface elevation	See Remarks				The elevation of the primary surface is the same as the elevation of the nearest point on the runway centerline or extended runway centerline.
4	Approach-departure clearance surface (ADCS) -- inner edge	152.5 m (500 ft)				Measured from runway end
5	ADCS Width at inner edge	152.5 m (500 ft)				
6	ADCS Slope	35H:1V	20H:1V	35H:1V	20H:1V	Remains constant throughout length
7	ADCS Slope length	Minimum 3200 m (10,500 ft)				The desired slope length is 9733 m (32,000 ft).
8	ADCS Width at outer edge	762 m (2,500 ft) at 3200 m (10,500 ft) from inner edge				Width of ADCS is constant from 3200 m (10,500 ft) to 9753 m (32,000 ft) from the inner edge.

Figure 7-1. LZ Primary Surface End Details

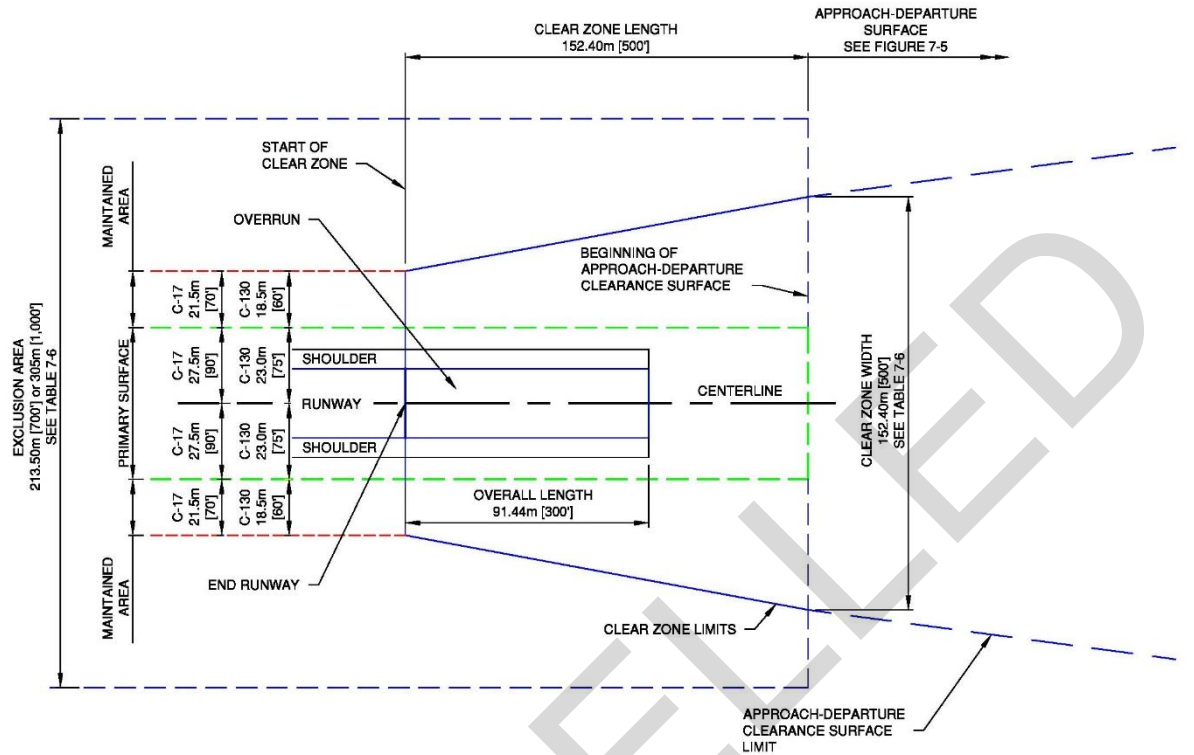

PLAN  
N.T.S.

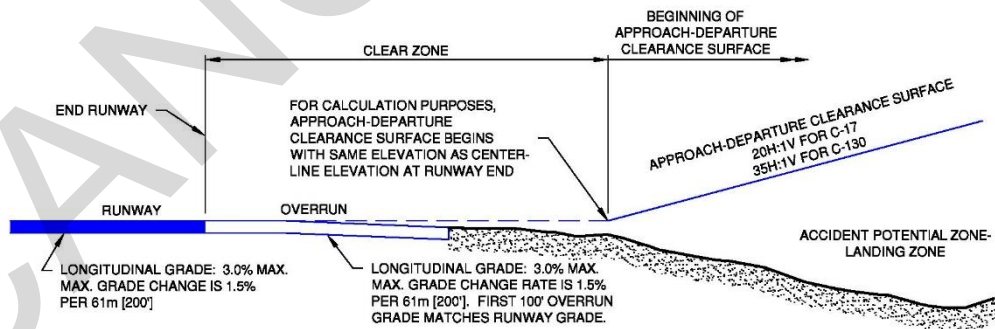

LONGITUDINAL PROFILE  
N.T.S.

NOTE

1. SEE PARAGRAPH 7-4 FOR INFORMATION ON SITING NEW LANDING ZONES.

Figure 7-2. LZ Details

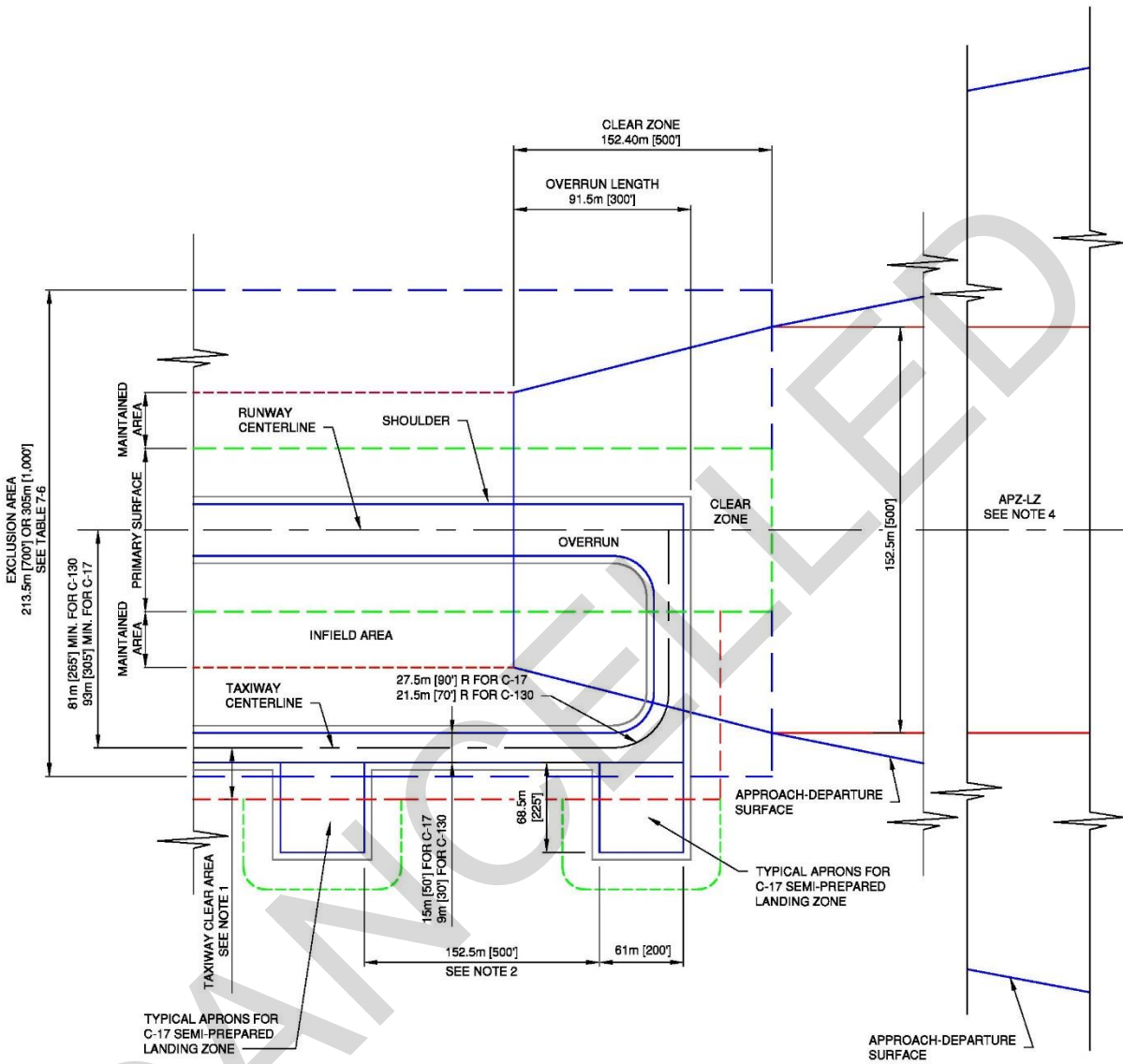

PLAN  
N.T.S.

NOTES

1. TAXIWAY CLEAR AREA WIDTH 33.5m [110'] FOR C-17 AND 29m [95'] FOR C-130 MEASURED FROM TAXIWAY CENTERLINE (TABLE 7-3, ITEM 11).
2. LOCATION AND SPACING BETWEEN MULTIPLE APRONS IS DETERMINED BY TOPOGRAPHY, MISSION AND OBSTRUCTIONS, BUT SHALL NOT BE LESS THAN 152.5m [500'] APART.
3. PARALLEL TAXIWAY OR TURNAROUND AREAS AT BOTH ENDS OF THE RUNWAY MUST BE PROVIDED.
4. SEE PARAGRAPH 7-4 FOR INFORMATION ON SITING NEW LZ'S.

Figure 7-3. LZ with Contiguous Aprons and Turnarounds

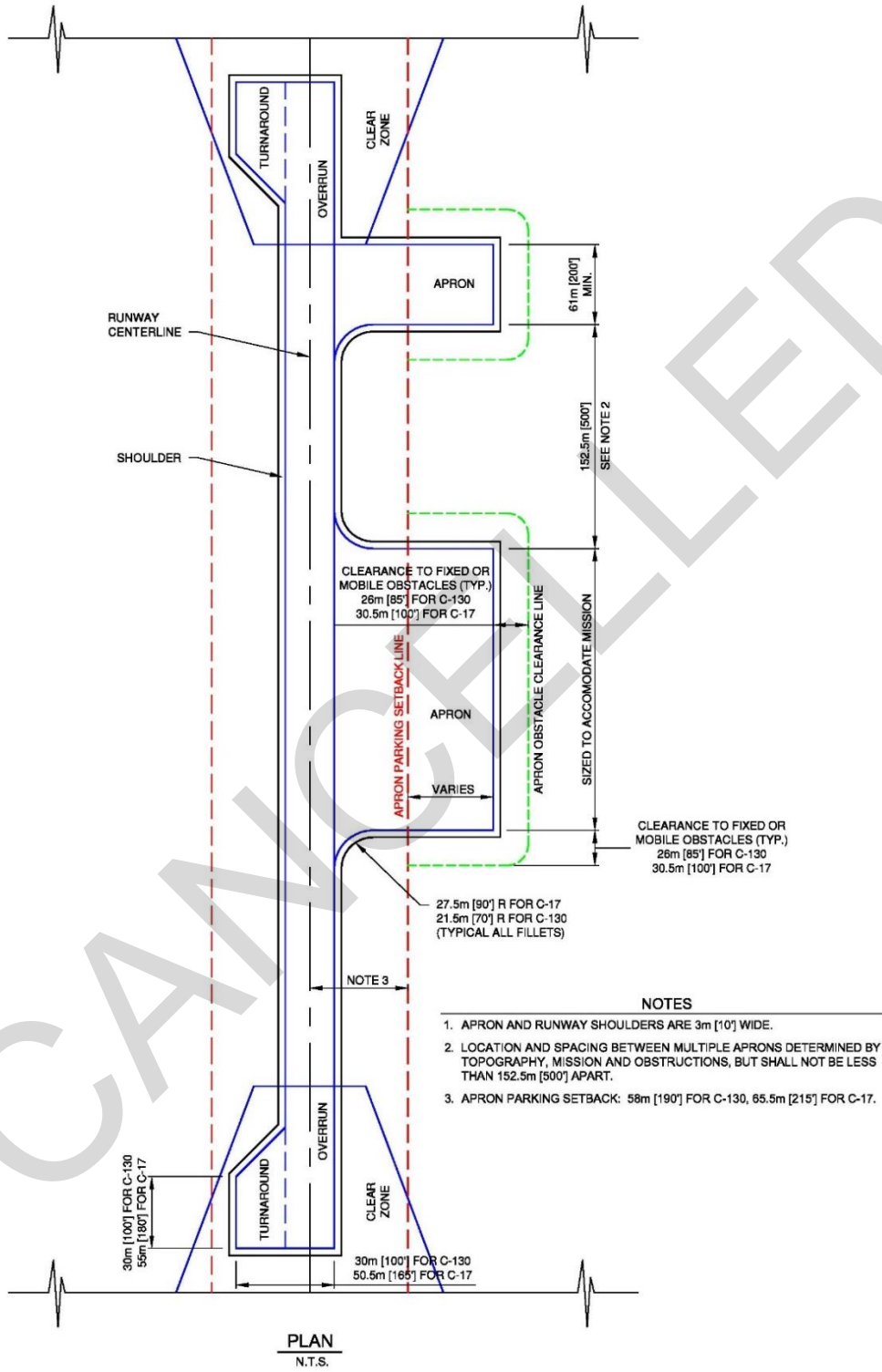



Figure 7-4. LZ Apron Layout Details

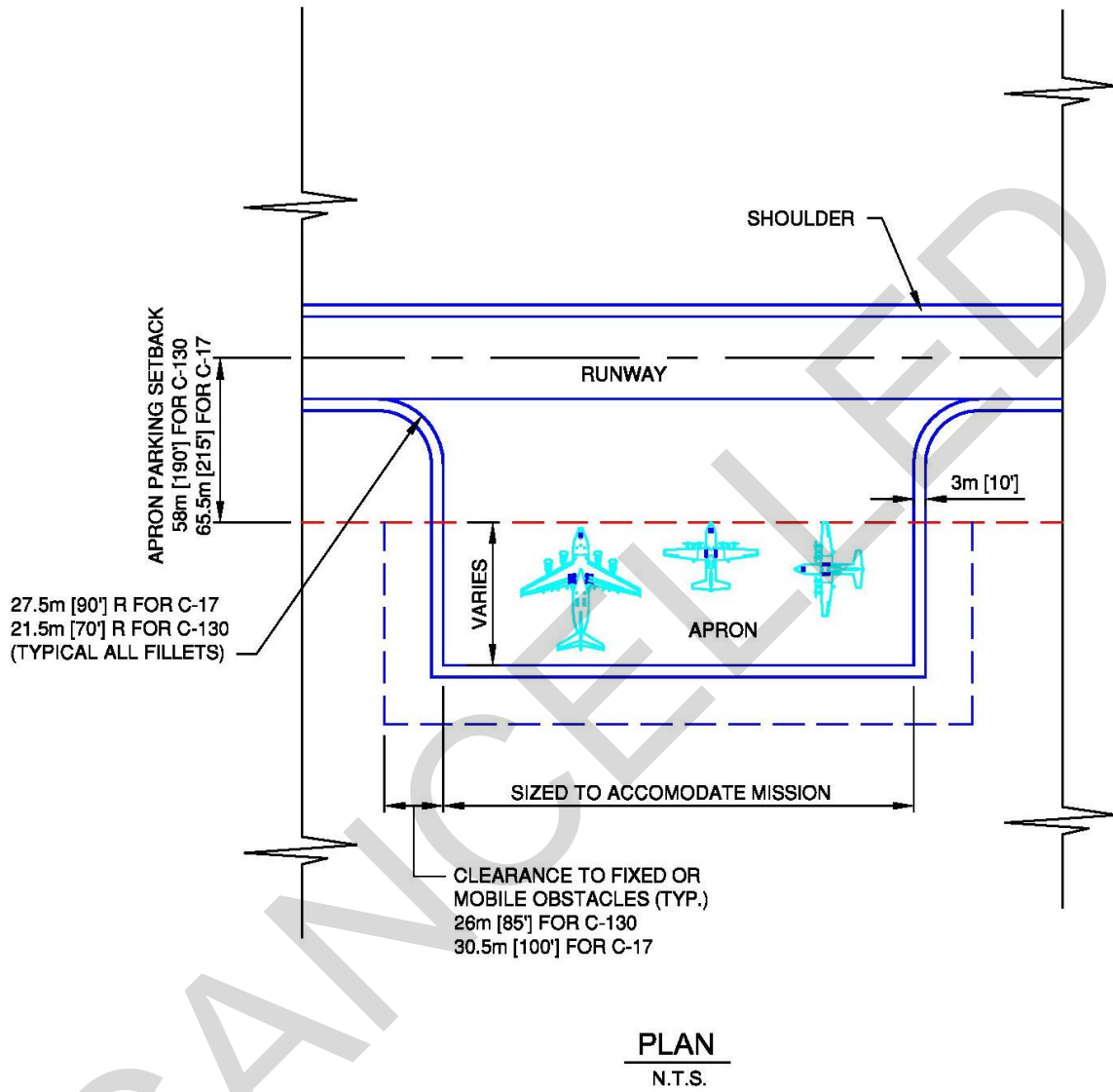
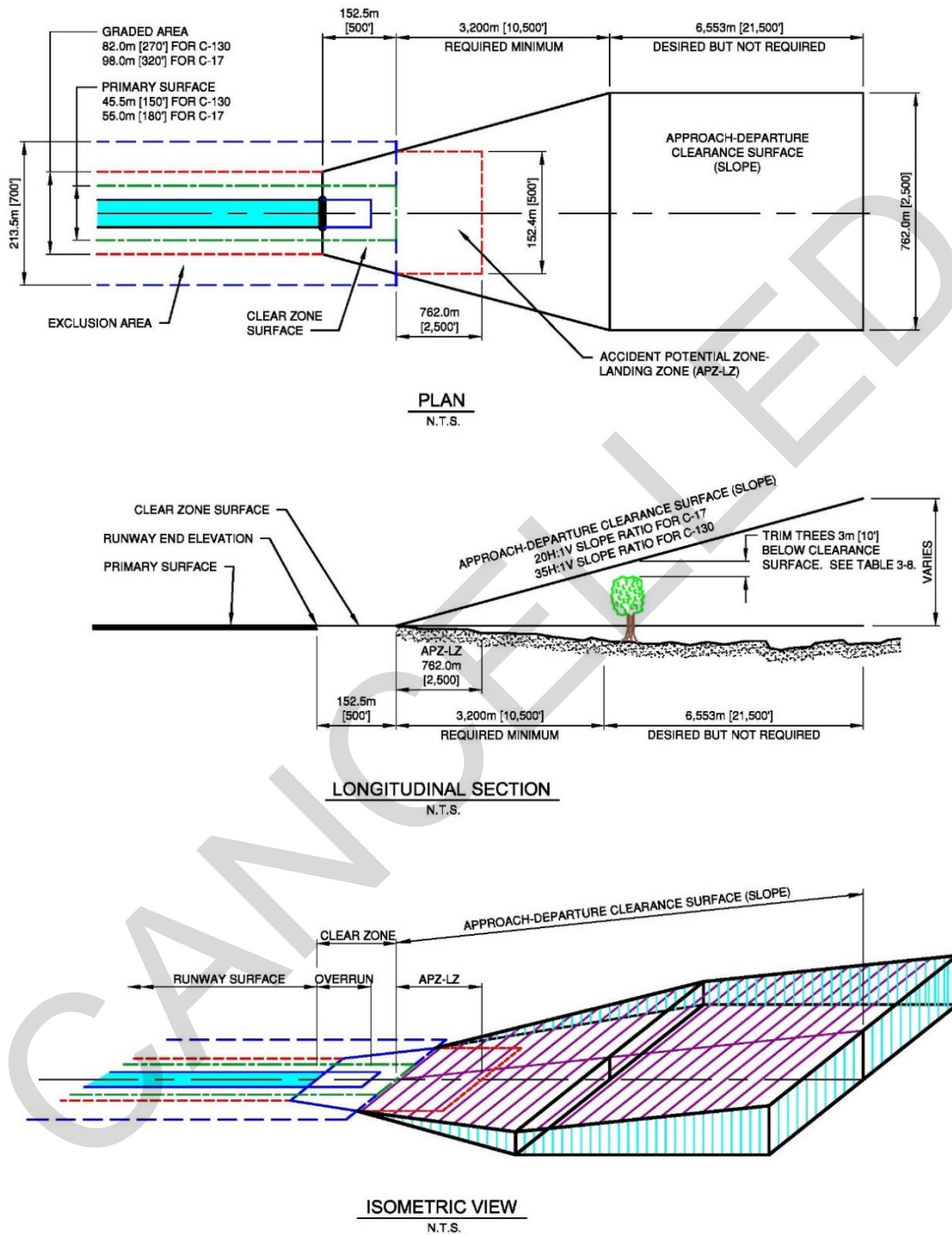

Figure 7-5. LZ Runway Imaginary Surfaces



NOTE

1. SEE PARAGRAPH 7-5 FOR INFORMATION ON SITING NEW LANDING ZONES.

Figure 7-6. LZ Runway, Taxiway, and Apron Sections

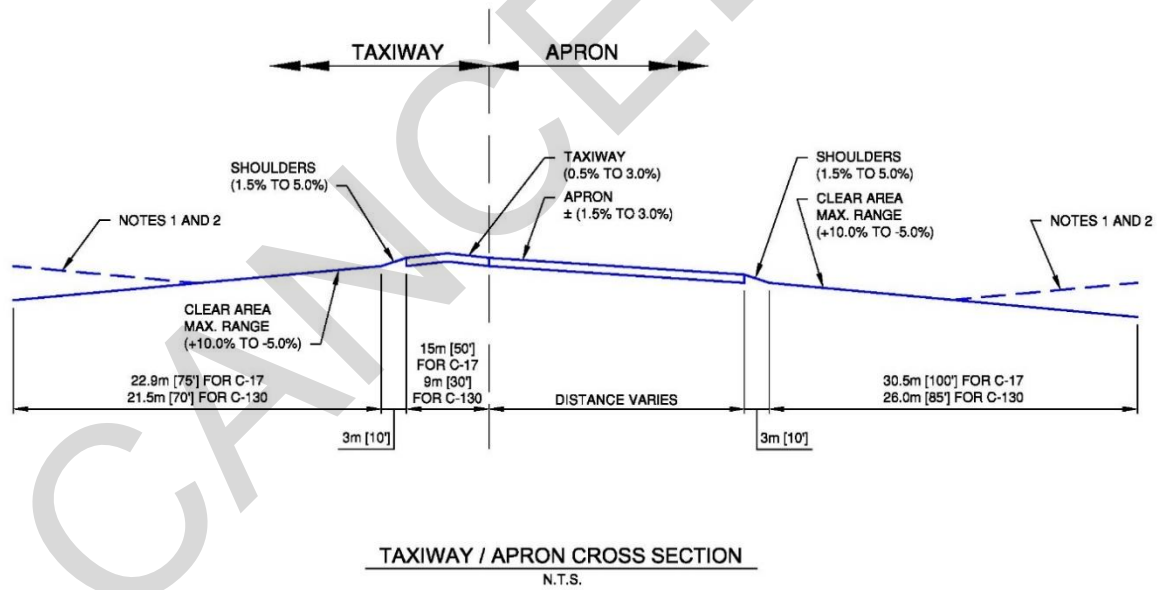
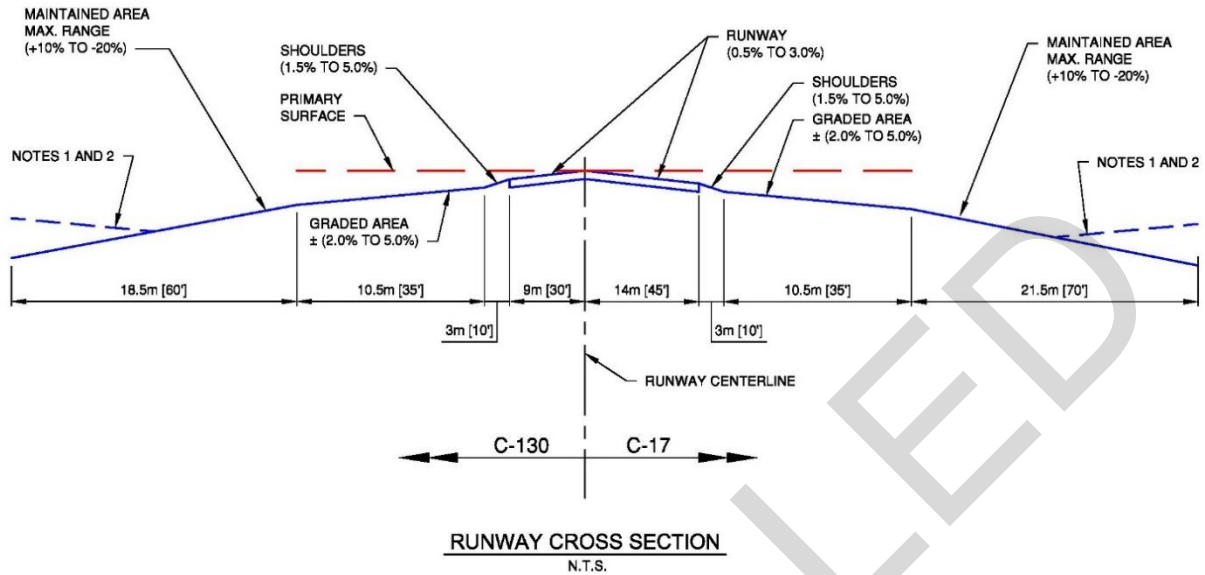

NOTES

1. A ± (1.5% TO 5.0%) GRADE MEANS THE SURFACE WILL BE SLOPED, EITHER POSITIVELY BETWEEN +1.5% AND +5.0% OR NEGATIVELY BETWEEN -1.5% AND -5.0%, BUT NOT LEVEL.
2. GRADE CHANGES (INCLUDING REVERSALS) ARE PERMITTED WITHIN THE RUNWAY GRADED AND MAINTAINED AREAS AND WITHIN THE TAXIWAY AND APRON CLEAR AREAS.

**7-7 OPERATIONAL WAIVERS TO CRITERIA.**

The criteria in this chapter are the minimum permissible for C-17 and C-130 operations. When deviations exist or occur at a specific location, an operational waiver must be obtained before beginning flying operations. Ensure a risk assessment is performed on all proposed operational waiver requests prior to submitting to the approval authority. The office of primary responsibility (OPR) for the mission or exercise will initiate the waiver request. If IFR procedures apply, proposed waivers must be coordinated with the appropriate TERPS office. The appropriate airfield survey team will verify existing LZ dimensions and grades. See Paragraph 1-7 and Appendix B, Section 1 for waiver processing procedures.

**7-8 SEPARATION DISTANCES BETWEEN PERMANENT RUNWAYS/HELIPADS AND LZ RUNWAYS.**

**7-8.1 Separation Distances between Permanent Runways/Helipads and LZ Runways for Simultaneous Operations.**

When simultaneous operations are desired on a permanent runway or helipad and an LZ runway, minimum separation distances are required as stipulated in Table 7-9.

**7-8.2 Separation between Permanent Class A or Class B Runways and LZ Runways for Non-Simultaneous Operations.**

At a minimum, LZ runways will be separated from permanent runways so as not to conflict with distance-remaining signs, runway edge lights, NAVAIDs (including glideslope signals), and other facilities associated with the runway.

**Table 7-9. Runway Separation for Simultaneous Operations**

Table 7-9. Runway Separation for Simultaneous Operations			
Item			
No.	Description	Requirement	Remarks
1	Distance between centerlines of parallel runways	762 m (2,500 ft)	IFR using simultaneous operation (depart-depart) (depart-arrival)
		1310.6 m (4,300 ft)	IFR using simultaneous approaches
2	Distance from the centerline of a fixed-wing runway to the centerline of a parallel rotary-wing	Min 213.4 m (700 ft)	Simultaneous VFR operations for Class A runway and Army Class B runway
		Min. 304.8 m (1,000 ft)	Simultaneous VFR operations for Class B runway for Air Force, Navy, and Marine Corps

Table 7-9. Runway Separation for Simultaneous Operations			
Item		Requirement	Remarks
No.	Description		
	runway, helipad, or landing lane	Min 213.4 m (700 ft)	Non-simultaneous operations Distance may be reduced to 60.96 m (200 ft); however, waiver is required and must be based on wake-turbulence and jet blast. In locating the helipad, consideration must be given to hold position marking. Rotary-wing aircraft must be located on the apron side of the hold position markings (away from the runway) during runway operations.
		Min. 762 m (2,500 ft)	IFR using simultaneous operations (depart-depart) (depart-approach)
		Min. 1310.6 m (4,300 ft)	IFR using simultaneous approaches

## 7-9 SURFACE TYPES.

Semi-prepared (unpaved) LZ surfaces may be composed of stabilized soils, aggregate surfaces, compacted native soils, or matting. Specific design guidance for semi-prepared surfaces can be found in ETL 97-9, *Criteria and Guidance for C-17 Contingency and Training Operations on Semi-Prepared Airfields* (or superseding document). Paved LZs may be surfaced with asphalt concrete (AC) or PCC pavement. On runways, taxiways, turnarounds, and aprons used by C-17 aircraft, asphalt pavement distress has been observed in areas where 90- to 180-degree turns are made; for this reason, PCC is preferred in areas where turning movements occur. Designers should consider durability and maintenance of the pavement, as well as economics, when selecting a surface type for an area associated with an LZ intended for long-term use. AC and PCC pavement structures will be designed to support the traffic level defined in UFC 3-260-02, *Pavement Design for Airfields*.

### 7-9.1 Runways and Overruns.

#### 7-9.1.1 Semi-prepared Runway and Overrun Surfaces.

Unpaved LZ runway and overrun surfaces will be designed to support the anticipated aircraft type, weight, and number of planned operations. Overruns will be designed to the same standard as the runway.

#### 7-9.1.2 Paved Runway and Overrun Surfaces.

Paved runways and overruns may be surfaced with AC or PCC pavement. Sawcut grooving may be used to improve drainage characteristics on runway surfaces only. Overruns will be designed to the same standard as the runway. Special design consideration is needed if the overrun is used as a taxiway or turnaround area.

### **7-9.1.3 Runway and Overrun Shoulders.**

For semi-prepared runways, the shoulder structure will be designed to the same standard as the runway. For paved runways, shoulders will be surfaced with AC or PCC pavement and will be designed to support the traffic level defined in UFC 3-260-02.

### **7-9.2 Turnarounds.**

Semi-prepared Turnarounds. Unpaved turnarounds will be designed to support the anticipated aircraft type, weight, and number of operations. Designers should give special consideration to stabilization for turnarounds used by C-17 aircraft because the surface can be easily damaged by the turning action of the main landing gear.

#### **7-9.2.1 Paved Turnarounds.**

Paved turnarounds may be surfaced with AC or PCC. Special consideration should be given to surface durability for turnarounds used by C-17 aircraft; for this reason, PCC pavement is preferred.

### **7-9.3 Taxiways.**

#### **7-9.3.1 Semi-prepared Taxiways.**

Unpaved taxiways will be designed to support the anticipated aircraft type, weight, and number of operations. Designers should give special consideration to stabilization at taxiway turns used by C-17 aircraft because the surface can be easily damaged by the turning action of the main landing gear.

#### **7-9.3.2 Paved Taxiways.**

Paved taxiways may be surfaced with AC, PCC. Special consideration should be given to surface durability for taxiways used by C-17 aircraft; for this reason, PCC pavement is preferred.

### **7-9.4 Aprons.**

#### **7-9.4.1 Semi-prepared Aprons.**

Unpaved aprons will be designed to support the anticipated aircraft type, weight, and number of operations. Designers should give special consideration to stabilization on aprons used by C-17 aircraft because the surface can be easily damaged by the turning action of the main landing gear.

#### **7-9.4.2 Paved Aprons.**

Paved aprons may be surfaced with AC, PCC. Special consideration should be given to surface durability and fuel resistance for aprons used by C-17 aircraft; for this reason, PCC pavement is preferred.

## **7-10 VISUAL LANDING ZONE MARKER PANELS (VLSMP).**

Various systems are used during daytime operations to provide visual cues to pilots about the location and dimensions of the LZ runway. The type of marker panels selected depends on the mission requirements and anticipated duration of LZ use. The following paragraphs describe requirements for temporary and long-term applications, respectively.

### **7-10.1 Minimum Marking Requirements for Temporary Applications.**

#### **7-10.1.1 Temporary Panels.**

LZ runways intended for short-term or temporary use should be marked with one of the arrangements of airfield marking patterns (AMP) defined in AFI 13-217, *Drop Zone and Landing Zone Operations*. The special tactics team (STT) will decide which arrangement of panels will be installed. The AMP-1, AMP-2 and AMP-3 layouts are illustrated in Figures 7-8a, 7-8b, and 7-8c. Although AMP-2 is also defined in AFI 13-217, the AMP-2 configuration will not be used for newly constructed temporary or permanent LZs by AMC. AMP-4 does not require any marker panels or lights and is only used for appropriate special operations.

#### **7-10.1.2 Materials and Size.**

Temporary panels may be constructed of fabric, wood, or other materials determined to be suitable by the STT. Panel faces will be at least 1524 millimeters (60 inches) wide and 432 millimeters (17 inches) tall. Airfield signs with solid panels rated for 300 mph have been commonly used.

#### **7-10.1.3 Orientation and Color.**

Marker panels should be erected upright and facing toward the aircraft approach to increase visibility to the pilot. The panels will be orange (Federal Standard 595, Color FS 18913, *Fluorescent Red Orange*), cerise (Federal Standard 595, Color FS 28915, *Fluorescent Red*), or other color acceptable to the STT. The specific color used and layout must be briefed to all participating units before operations commence.

#### **7-10.1.4 Frangibility.**

For temporary applications, frangible marker panels and supports are preferred to avoid excessive damage if struck by an aircraft. If available, VS-17 marker panels (National Stock Number [NSN] 8345-00-174-6865, Part Number MIL-P-400-61) should be used to mark temporary LZs for daytime operations.

### **7-10.2 Marking Requirements for Long-Term Applications.**

#### **7-10.2.1 Permanent Panels.**

LZs intended for long-term use should have permanently installed panels of the type described below. Panel locations are derived from the patterns shown in AFI 13-217, Figures 3.1, 3.3, and 3.5. Panels will be installed at the locations shown in Figures 7-8a or 7-8b, depending on the desired AMP. In AMP-1, spacing will be consistent through the intermediate panels. If a conflict with the panels exists on one or both sides of the LZ (e.g., at locations where a taxiway connects to the LZ), that panel should be omitted. For bi-directional operations, panels of the appropriate color will be attached to each side of the support posts. See Figures 7-8a and 7-8b, Note 2, for the distance between the panels and the runway edge. Panels should be 1.8 meters (6 feet) apart at locations where panels are placed in pairs.

#### **7-10.2.2 Materials and Size.**

Panel surfaces may be constructed of any lightweight yet durable material suitable for the environment. Panel surfaces will be at least 1524 millimeters (60 inches) wide and 610 millimeters (24 inches) tall. Airfield signs with solid panels rated for 300 mph have been commonly used.

#### **7-10.2.3 Orientation and Color.**

Marker panels should be erected upright and facing toward the aircraft approach to increase visibility to the pilot. The panels should be covered with reflective sheeting material or painted orange (Federal Standard 595, Color FS 18913, *Fluorescent Red Orange*), or cerise (Federal Standard 595, Color FS 28915, *Fluorescent Red*), the colors indicated in Figures 7-8a and 7-8b. (**Note:** Alternate colors may be used if all participating units are briefed and concur with the color selection. For example, all panels may be orange.) Reflective sheeting will be 3M™ diamond grade or equivalent. Panels must be designed to withstand jet blast effects. A panel design that has been used successfully is illustrated in Figure 7-7.

#### **7-10.2.4 Foundations.**

A reinforced concrete foundation pad should be used to support and anchor the panel support posts. Sample details for a foundation are shown in Figure 7-7.

#### **7-10.2.5 Support Posts.**

Support posts are needed to hold the panels upright. Posts must be strong enough to withstand jet blast and also frangible to break away upon impact. Posts will meet the frangibility definitions, acceptance criteria, analysis and testing requirements defined in Appendix B, Section 13. The support will have frangible points located 51 millimeters (2 inches) or less above the concrete pad. The frangible points will withstand wind loads due to jet blasts of 482 kilometers per hour (300 miles per hour) but will break or give way before reaching an applied static load over the surface of the sign of 8.9 kilopascals (1.3 pounds per square inch).



Figure 7-7. Example VLZMP on Concrete Base Detail

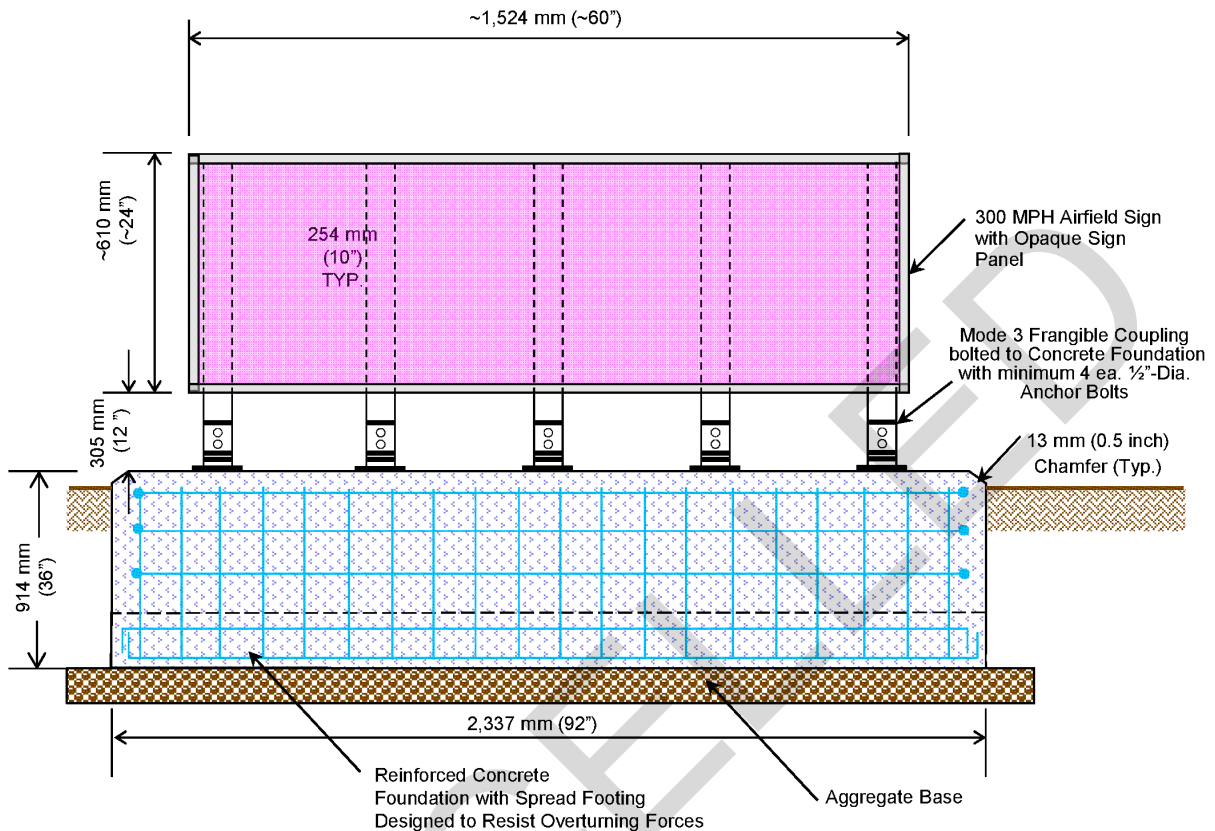

Notes:

1. Example panel design. Panel minimum dimensions must be met, but panel materials, posts, and foundation can be modified by the designer.
2. Refer to Figure 7-8a or 7-8b for locations and color scheme layout.
3. Foundation depth shall be minimum 914 millimeters (36 inches) or 152 millimeters (6 inches) deeper than the frost line. Foundation upper wall width shall be minimum 305 mm (12 inches). Foundation spread footing shall be minimum 305 mm (12 inches) thick. Spread footing width shall be as needed to resisting overturning moment created by jet blast and 300 mph wind on sign. Reinforcing shall be determined by designer.
4. Top of concrete pad shall be 13 millimeters (0.5 inch) above surrounding ground. Maximum allowable height above ground is 38 millimeters (1.5 inches). Slope concrete 6 millimeters (0.25 inch) per foot away from panel.
5. Frangible coupling or hinge point shall be located 13 millimeters (0.5 inch) above top of concrete pad.
6. For erosion protection and to ease mowing, install minimum 1.5 m (5 ft) asphalt pad around concrete foundation, flush with ground surface and sloped to promote drainage.

Figure 7-8. Airfield Marking Patterns (AMP)

Figure 7-8a – Airfield Marking Pattern 1 (Day)

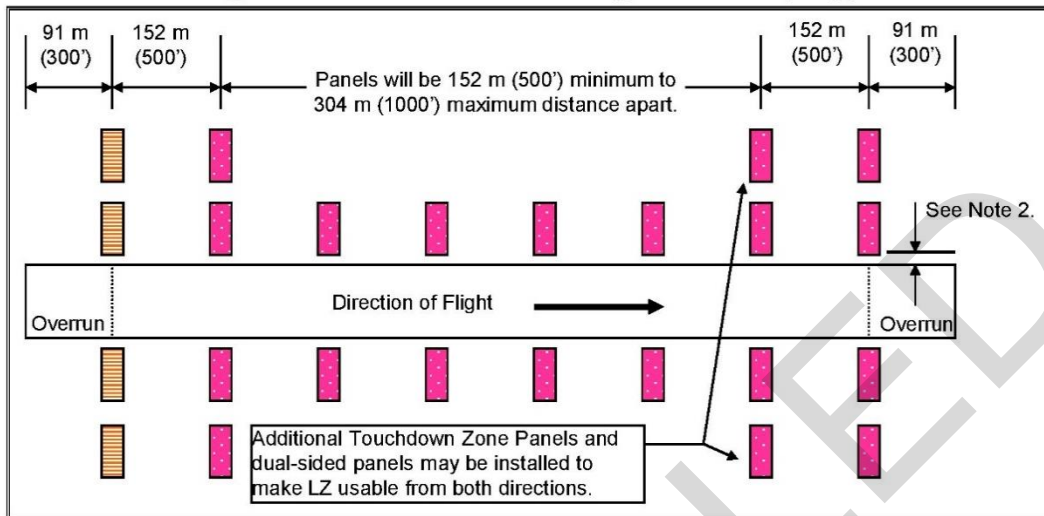

**Airfield Marking Pattern 2 (Day) - NOT USED**

Figure 7-8b – Airfield Marking Pattern 3 (Day)

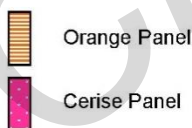
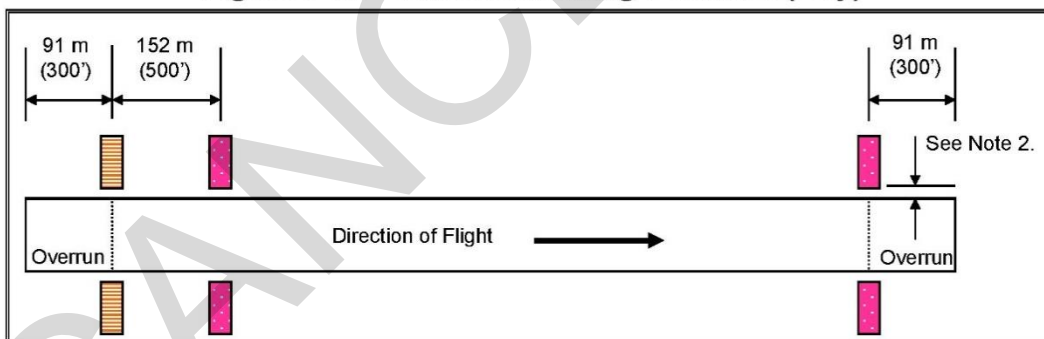

Notes:

1. Alternate colors may be used if all participating units are briefed and concur with the color selection. For example, all panels may be orange.
2. If runway edge lights are not installed on the LZ, place inner edge of panels 1.2 m (4') minimum, 3 m (10') maximum from the edge of the runway. If runway edge lights are installed, place inner edge of panels 3.6 m (12') minimum, 9 m (30') maximum from the edge of the runway so that panels do not block view of the runway edge lights.
3. See Figure 7-14 for additional panel layout dimensional details.

## **7-11 LZ LIGHTING.**

Various systems are used during daytime operations to provide visual cues to pilots about the location and dimensions of the LZ runway. The type of marker panels selected depends on the mission requirements and anticipated duration of LZ use. The following paragraphs describe requirements for temporary and long-term applications, respectively.

### **7-11.1 Minimum Lighting Requirements for Temporary Applications.**

#### **7-11.1.1 Lights.**

If available, lights should be omni-directional steady-burn or flashing with a minimum output rating of 15 candela for night operations. In accordance with AFI 13-217, virtually any type of lighting system is acceptable if all participating units are briefed and concur with its use. Contingency lighting kits (emergency airfield lighting system [EALS]) or other materials may be used as available and determined to be suitable by the STT.

#### **7-11.1.2 Location.**

There are three types of airfield lighting patterns for LZs, designated AMP-1, AMP-2, and AMP-3, as defined in AFI 13-217. AMP-4 is lights-out, no markings, and used only for appropriate special operations. The STT will decide which arrangement of lights will be installed. The AMP-1, AMP-2, and AMP-3 layouts are illustrated in Figures 7-9a, 7-9b, and 7-9c. Although AMP-2 is also defined in AFI 13-217, the AMP-2 configuration will not be used for newly constructed temporary or permanent LZs by the Air Force. When constructing new LZs, even if the immediate operational need is for AMP-3, consideration should still be given to installing the light bases and conduits to support the AMP-1 configuration.

### **7-11.2 Lighting Requirements for Permanent Applications.**

When intended for long-term use, use permanently installed lights of the type and in the locations described below.

#### **7-11.2.1 Light Fixtures.**

Certify all light fixtures. Procure and install only those light fixtures listed in FAA AC 150/5345-53, *Airport Lighting Equipment Certification Program*, and FAA AC 150/5345-46, *Specification for Runway and Taxiway Light Fixtures*. IR filters will be used with fixtures listed in paragraph 7-11.7 when IR capabilities are required as part of the installation.

##### **7-11.2.1.1 Runway Lights.**

Runway high-intensity edge light fixtures will be used for permanent LZ lighting installations. Runway edge lights will be elevated FAA Type L-862. Use the L-850C when an inset light is required in place of the L-862. If the LZ is superimposed on an

existing runway or taxiway where normal flight operations are conducted then use semi-flush light fixtures. If all edge lights are semi-flush edge lights, use the FAA Type L-850A, Style 3 (Runway, Uni-directional) towards the approach. (Where circling guidance is needed, bi-directional light fixtures may be used.) LZ light lens colors will be as indicated in Figures 7-9a, 7-9b, and 7-9c. Five-step regulators will be installed. (Steps 1 through 3 are compatible with NVG operations using a five-step regulator.)

#### **7-11.2.1.2 Taxiway Lights.**

Taxiway medium-intensity edge light fixtures will be used for permanent lighting installations. Taxiway edge lights will be elevated FAA Type L-861T. If needed, semi-flush edge lights will be FAA Type L-852T, Style 3 (Taxiway, Omni-directional). Taxiway and turnaround edge light lenses will be blue. Three-step regulators will be installed for intensity control.

#### **7-11.2.1.3 Flashing Strobe Lights (FSL).**

These light fixtures are located at the end of the LZ in the AMP-3 and AMP-2 configurations and at each side of the approach threshold in the AMP-1 configuration. These lights are uni-directional and must flash at a rate of 28 to 34 flashes per minute, producing a white light. Semi-flush fixtures (FAA-E-2952, Style A, white) will be installed with the edge of the fixture extending no more than 1.5 millimeters (0.0625 inch) below and 0.0 millimeter (0.0 inch) above the pavement top. Aim the fixture(s) down the runway parallel to the centerline for AMP-2 and AMP-3 and towards the approach for AMP-1.

#### **7-11.2.2 Light Bases.**

Light fixtures will be attached to full-depth light bases (L-868, Class IB). Light bases will be offset so the fixture center is a minimum of 0.6 meter (2 feet) from any pavement joint. Light bases will be installed in accordance with UFC 3-535-01. For elevated light fixtures, provide steel adaptor rings. Light construction tolerances are:

Longitudinal	± 13 millimeters (0.5 inch) from stationing
Transverse	± 13 millimeters (0.5 inch) transverse from centerline
Base orientation	Parallel to T/W centerline ± 0.5 degree
Elevation	+0 to -1.5 millimeters (+0 to -0.0625 inch) from finished pavement surface, flush with the surrounding grade or pavement.

#### **7-11.3 Light Locations.**

See paragraph 7-11.6 for guidance on LZ lights superimposed on Class A or Class B runways.

**7-11.3.1 AMP-1.**

Lights will be placed at each threshold and at 152 meters (500 feet) from each threshold. Intermediate lights will be 152 meters minimum/305 meters maximum (500 feet minimum/1000 feet maximum) spacing throughout the length of the runway, as illustrated in Figures 7-9a and 7-13. Spacing will be consistent through the intermediate lights. If a conflict with the lights exists on one or both sides of the LZ (e.g., at locations where a taxiway connects to the LZ), that light will be a semi-flush light. Synchronized FSLs will be installed at the threshold as illustrated in Figures 7-9a and 7-13. Steady-burning light fixtures will be installed at 1.6 meters (5 feet) plus 0.6 meter (2 feet) to minus 0.0 meter (0.0 foot) from the edge of the LZ surface (i.e., within the shoulder pavement). Light pairs will be perpendicular and equidistant from the runway centerline to be symmetrical about the runway or LZ centerline.

**7-11.3.2 AMP-2.**

Lights will be placed at each threshold and at 152 meters (500 feet) from each threshold. Intermediate lights will be 152 meters minimum/305 meters maximum (500 feet minimum/1000 feet maximum) spacing throughout the length of the runway, as illustrated in Figure 7-9b. Spacing will be consistent through the intermediate lights. If a conflict with the lights exists on one or both sides of the LZ (e.g., at locations where a taxiway connects to the LZ), that light will be a semi-flush light. An FSL is also installed on the centerline of the departure end threshold not more than 1.6 meters (5 feet) from the threshold or overrun end. Locate the FSL as close to the runway centerline as possible. Steady-burning light fixtures will be installed 1.6 meters (5 feet) plus 0.6 meter (2 feet) to minus 0.0 meter (0.0 foot) from the edge of the LZ surface (i.e., within the shoulder pavement). Installations requiring infrared capability will include the provisions of paragraph 7-11.7.

**7-11.3.3 AMP-3.**

Light locations and colors are derived from the AMP-3 configuration in AFI 13-217, Figure 3.6. Steady-burning lights will be placed at the threshold and at 152 meters (500 feet) from the approach end threshold, forming a box, as shown in Figures 7-9c, 7-14, and 7-15. An FSL is also installed on the centerline of the departure end threshold not more than 1.6 meters (5 feet) from the threshold or overrun end. Locate the FSL as close to the runway centerline as possible. Steady-burning light fixtures will be installed at 1.6 meters (5 feet) plus 0.6 meter (2 feet) to minus 0.0 meter (0.0 foot) from the edge of the LZ surface (i.e., within the shoulder pavement). Installations requiring infrared capability will include the provisions of paragraph 7-11.7.

**7-11.3.4 Turnaround, Taxiway, and Apron Edge Lights.**

All lights will be installed at 1.6 meters (5 feet) plus 0.6 meter (2 feet) or minus 0.0 meter (0.0 foot) from the edge of the load-bearing surface. On straight sections of taxiway or

turnaround, lights will be spaced evenly with a maximum of 152 meters (500 feet) between lights. See Figures 7-12 and 7-13, for typical turnaround and taxiway edge light locations. Light spacing will be reduced to between 3 meters and 10.6 meters (10 feet and 35 feet) on curves and at corners or intersections. On curved sections, lights will be evenly spaced from point of tangency (PT) to PT, with the maximum spacing between lights equal to half the taxiway width. For all corners and all curves exceeding 30 degrees of arc, there will be a minimum of three lights. See UFC 3-535-01, Chapter 5, for additional edge light location details.

#### **7-11.3.5 Overrun Edge Lights.**

Overruns do not normally require edge lights; however, for overruns used as taxiways or turnarounds, edge lights may be installed using the location criteria stated in paragraph 7-11.3.4. In addition, the first pair of edge lights installed on overruns should not be more than 30.5 meters (100 feet) from the runway threshold.

#### **7-11.4 Light Circuits and Controls.**

Designers should investigate all required configurations of lighting (AMP-1, AMP-3 (Visual Spectrum), Infrared AMP-3, etc.) and develop a circuit and control system that can achieve all the required configurations.

##### **7-11.4.1 Ferro-Resonant Regulators.**

All new regulators used for LZ lighting systems will be ferro-resonant type.

##### **7-11.4.2 Multi-Regulator Systems.**

In this configuration, separate regulators will be needed to control lights for AMP-1, AMP-3 (Visual Spectrum), Infrared AMP-3, and taxiway circuits.

##### **7-11.4.3 Single-Regulator Systems with Addressable Lights.**

Systems are now available to have “assignable control” of individual lights via a carrier signal. For this type of configuration, all LZ runway lights could be powered by one regulator, with each configuration assigned to a different control setup.

##### **7-11.5 Light Reflector Panels (Optional).**

Light reflectors may be installed at the mid-point between LZ runway edge lights or taxiway edge lights. Contact the STT for information on obtaining light reflector panels.

Figure 7-9. Lighting Plans

Figure 7-9a – AMP-1 Lighting Plan

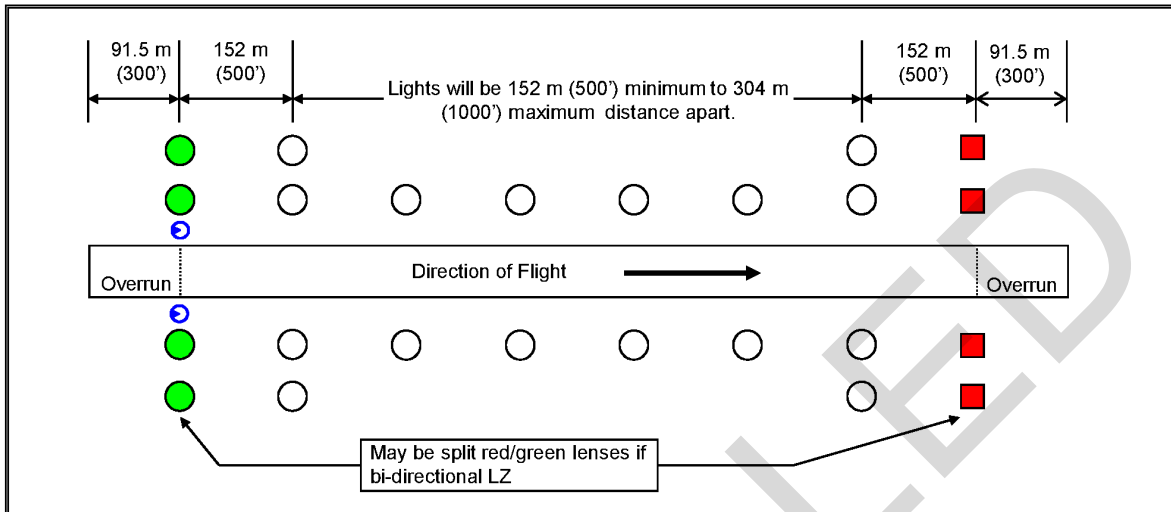
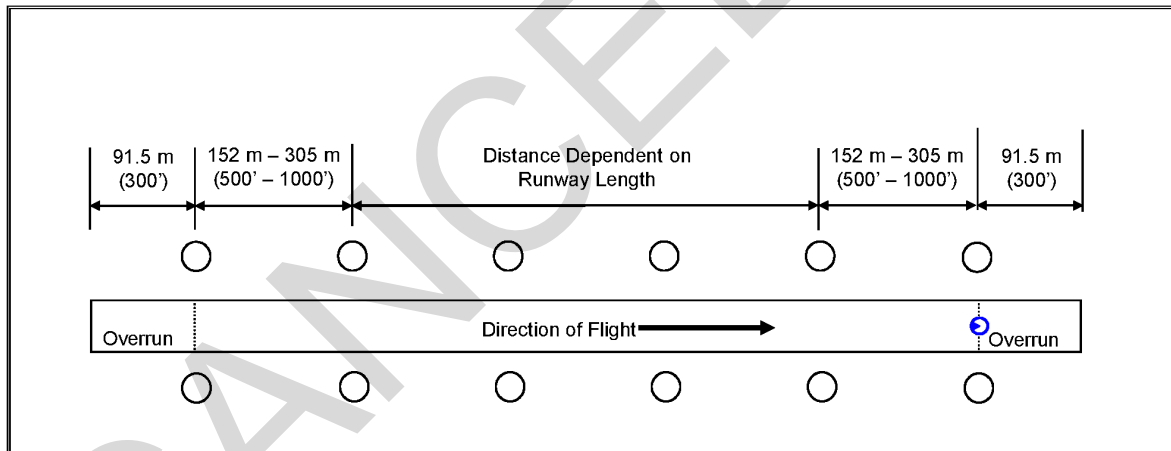

Figure 7-9b – AMP-2 Lighting Plan



- Green Runway Edge Light
- White Runway Edge Light
- Red Runway Edge Light

- ⦿ Flashing White Strobe Light. For AMP-1, lights at approach end must be synchronized for simultaneous flash. For AMP-3, place on centerline at the end of the usable runway or the end of the overrun when the overrun is used for taxiing.

Notes:

1. See Figure 7-13 for additional light layout dimensional details.

Figure 7-9. Lighting Plans (continued)

Figure 7-9c – AMP-3 Lighting Plan

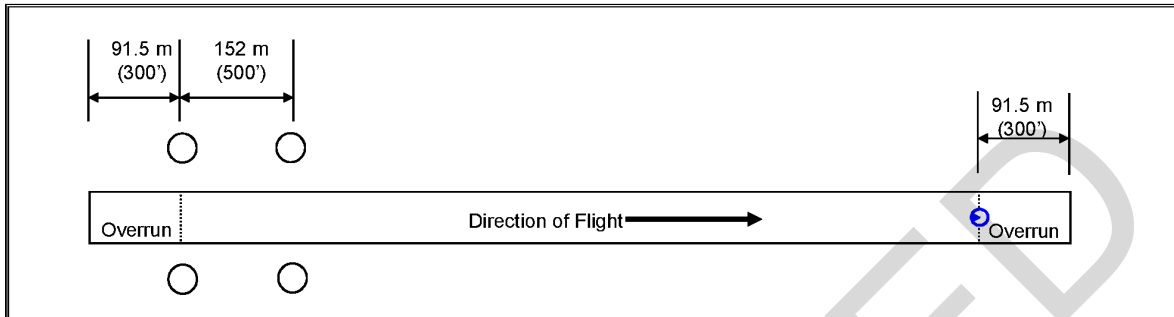

- Green Runway Edge Light
- White Runway Edge Light
- Red Runway Edge Light

- Flashing White Strobe Light. For AMP-1, lights at approach end must be synchronized for simultaneous flash. For AMP-3, place on centerline at the end of the usable runway or the end of the overrun when the overrun is used for taxiing.

Notes:

1. See Figure 7-13 for additional light layout dimensional details.

### 7-11.6 AMP-3 (Visual Spectrum) LZ Lights Superimposed on Standard Operational Runways.

In some cases, it may be desirable to use a standard full-length runway for LZ training operations. Only the AMP-3 configuration should be installed in this situation. For this purpose, the LZ lighting scheme illustrated in Figures 7-15, 7-16 and 7-17, will be applied, subject to the following conditions. Service-specific airfield management approval is required before installation of AMP-2 configuration.

#### 7-11.6.1 LZ Light Fixtures.

High-intensity light fixtures must be installed flush with the pavement surface to allow traffic to pass over them. Semi-flush lights will be FAA Type L-850A, Style 3, uni-directional, or an International Civil Aviation Organization (ICAO) equivalent. LZ light lens colors will be white. Five-step regulators will be installed on the LZ circuit(s) for light intensity control compatible with NVG operations (steps 1 through 3 are compatible with NVG operations).

#### 7-11.6.2 LZ Location on the Runway.

When possible, the LZ threshold should be sited between 91 meters (300 feet) and 152 meters (500 feet) from the runway threshold. This will ensure aircraft loads are



concentrated in the portion of the runway designed for heavier loads and avoid conflicts with runway pavement markings.

### **7-11.6.3 LZ Lighting Conflicts with Standard Runway Markings.**

The LZ should be sited so the LZ light fixtures do not conflict with threshold markings, runway designation markings, touchdown zone markings, or fixed distance markings. An ideal location for the LZ threshold is 91 meters (300 feet) from the runway threshold. This will position the LZ light fixtures in the gaps between the standard runway markings. If LZ lights fall within a standard marking, the light fixture should be masked whenever repainting occurs.

### **7-11.6.4 LZ Lighting Conflicts with Approach Lights and Touchdown Zone (TDZ) Lights.**

Runway approach lights and TDZ lights are spaced every 30 meters (100 feet) throughout the overrun and for the first 914 meters (3000 feet) of the runway. TDZ lights are installed in groups of three, starting 11 meters (36 feet) each side of the runway centerline and spaced over a 3-meter (10-foot) light bar. LZ lights for C-17s will not conflict with TDZ lights because LZ lights are 15 meters (50 feet) each side of the centerline. C-130 LZ lights are installed 10.5 meters (35 feet) each side of the centerline, so conflicts should not occur. If TDZ lights are installed on the runway, move the LZ lights closer to the LZ edge to position them inside the TDZ lights.

### **7-11.7 Infrared (IR) AMP-3 and AMP-2 Lights.**

#### **7-11.7.1 Installation.**

At some locations, IR lights may be needed in addition to standard visual spectrum lights. IR lights can be installed in accordance with Figures 7-12, 7-13, 7-14 and 7-15.

#### **7-11.7.2 IR Light Fixtures.**

Procure and install FAA L-850A Style 3 fixtures, with infrared transmitting filter installed on the lens. Use only infrared transmitting filters will meet the specifications in Table 7-10 and the spectral transmittal limits required by the contracting officer. Use only infrared transmitting filters that are certified by an FAA-approved laboratory (currently Intertek Test Lab) to comply with the specifications in this paragraph and the required spectral transmittal limits. Submit to the contracting officer an FAA approved lab (currently Intertek Test Lab) report certifying compliance prior to installation.

**Table 7-10. Infrared Transmitting Filter Specifications**

Physical Properties	
Nominal thickness range	4–6 mm 0.17–0.23 in
Thermal linear expansion	110x10 <sup>-7</sup> /°C (30–300 °C) (86–572 °F)
Refractive index (n)	1.53
Density	2.67 g/cc
Strain temperature	492 °C (918 °F)
Transition temperature	510 °C (950 °F)
Anneal temperature	526 °C (979 °F)
Deformation temperature	563 °C (1045 °F)

### 7-11.8 Snowplow Rings.

Steel rings are used to protect semi-flush light fixtures in areas that are plowed for snow removal. See guidance on materials, configuration and installation procedures in FAA Engineering Brief No. 85, *Ductile Snowplow Protection Ring and Installation Procedures*.

## 7-12 PAVEMENT MARKINGS.

### 7-12.1 Minimum Requirements.

No pavement markings are required; however, at locations where LZs are paved and will be used for the long-term, it is desirable to apply painted markings to the pavement surface as described below. See Figures 7-11, 7-12, and 7-13 for illustrations of LZ pavement markings.

### 7-12.2 Markings on Semi-Prepared LZs.

#### 7-12.2.1 Paint.

It is generally not practical to apply paint to unpaved surfaces. However, markings are desirable to delineate the edge of operational surfaces, particularly turnaround areas. If the semi-prepared surfaces are stabilized, then painted markings may be feasible but will likely require frequent repainting.

#### 7-12.2.2 Alternate Markings.

Alternatively, “stake chasers” can be installed along the edges of semi-prepared surfaces. Stake chasers are 150-millimeter (6-inch) flexible plastic bristles that attach to a 60-penny (60d) nail or a wooden stake. They are available in a variety of colors and can be purchased from survey supply stores. When used, the stake chasers should be installed at 7.6 to 15.2 meters ± 1.5 meters (25 to 50 feet ± 5 feet) intervals and driven into the ground so only 100 millimeters (4 inches) of the 150-millimeter (6-inch) whiskers

are visible (exposed length may be dependent on soil conditions). This will help ensure the stakes are not dislodged by traffic or jet blast. When possible, install stake chasers with colors corresponding to the edge light (white = runway edge, blue = taxiway and turnaround edge). Stake chasers are illustrated in Figure 7-10.

**Figure 7-10. Stake Chasers for Marking Edges of Semi-Prepared LZs, Taxiways and Turnarounds**



### **7-12.3 Marking Requirements for Long-Term Use on Pavements.**

#### **7-12.3.1 Marking Material.**

Use paint to apply markings to paved LZs, turnarounds, aprons, and taxiways. Paint should be applied at 0.305 to 0.356 millimeter (12 to 13 mils) wet film thickness for a desired dry film thickness of approximately 0.203 millimeter (8 mils). At this rate, coverage will be approximately 11 square meters (121 square feet) per gallon. Normally, LZ markings should not be reflective to improve realism for operating on a semi-prepared LZ. However, for LZs that need additional reflectivity, glass beads (Type I or Type III) will be applied at a rate of approximately 3.6 to 4 kilograms (8 to 9 pounds) per gallon of paint.

#### **7-12.3.2 Threshold Bar.**

White threshold stripes may be marked at each end of the LZ runway to distinguish between the overrun and LZ runway surface. The marking will be 1.2 meters (4 feet) wide and extend from edge to edge of the LZ surface.

#### **7-12.3.3 LZ Edge Stripes.**

White side stripes should only be painted when there is no visual distinction between the LZ runway surface and the paved shoulder (e.g., both LZ runway and shoulder are asphalt). Edge stripes will be 0.3 meter (1 foot) wide and extend along the entire length of the LZ runway.

#### **7-12.3.4 Taxiway Centerline.**

If the LZ runway has connecting taxiways, the taxiway centerline turn radius will not be extended onto the LZ runway surface.

#### **7-12.3.5 Taxiway, Apron, and Turnaround Edge Stripes.**

If taxiways, aprons or turnarounds have paved shoulders and there is no visual distinction between the edge of load-bearing pavement and the shoulder, the edge of full-strength pavement will be marked with two 152-millimeter (6-inch) wide yellow stripes separated by a 152-millimeter (6-inch) wide gap.

#### **7-12.3.6 Holding Position Markings.**

The holding position is located a minimum of 30.5 meters (100 feet) from the near edge of the runway. This distance is measured perpendicular to the long axis of the LZ. For holding position marking dimensions, see Service-specific airfield marking guidance.

#### **7-12.3.7 Touchdown Box Markings (Optional).**

When desired by the airfield manager, touchdown box markings may be applied. These markings consist of 0.9-meter (3-foot) -wide white stripes that extend transversely across the entire width of the runway surface. The stripes are located 30.5 meters and 152 meters (100 feet and 500 feet) from the approach end threshold.

#### **7-12.3.8 Runway Designation Markings.**

Runway designation markings will not be used on LZ runways.

#### **7-12.3.9 Runway Centerline (Optional).**

When desired by the airfield manager, runway centerline stripes may be applied. Stripes are 0.5 meter to 0.9 meter (1.5 feet to 3 feet) wide and 30.5 meters (100 feet) long, with an 18.3-meter (60-foot) gap between stripes.

Figure 7-11. LZ Painted Marking Layout

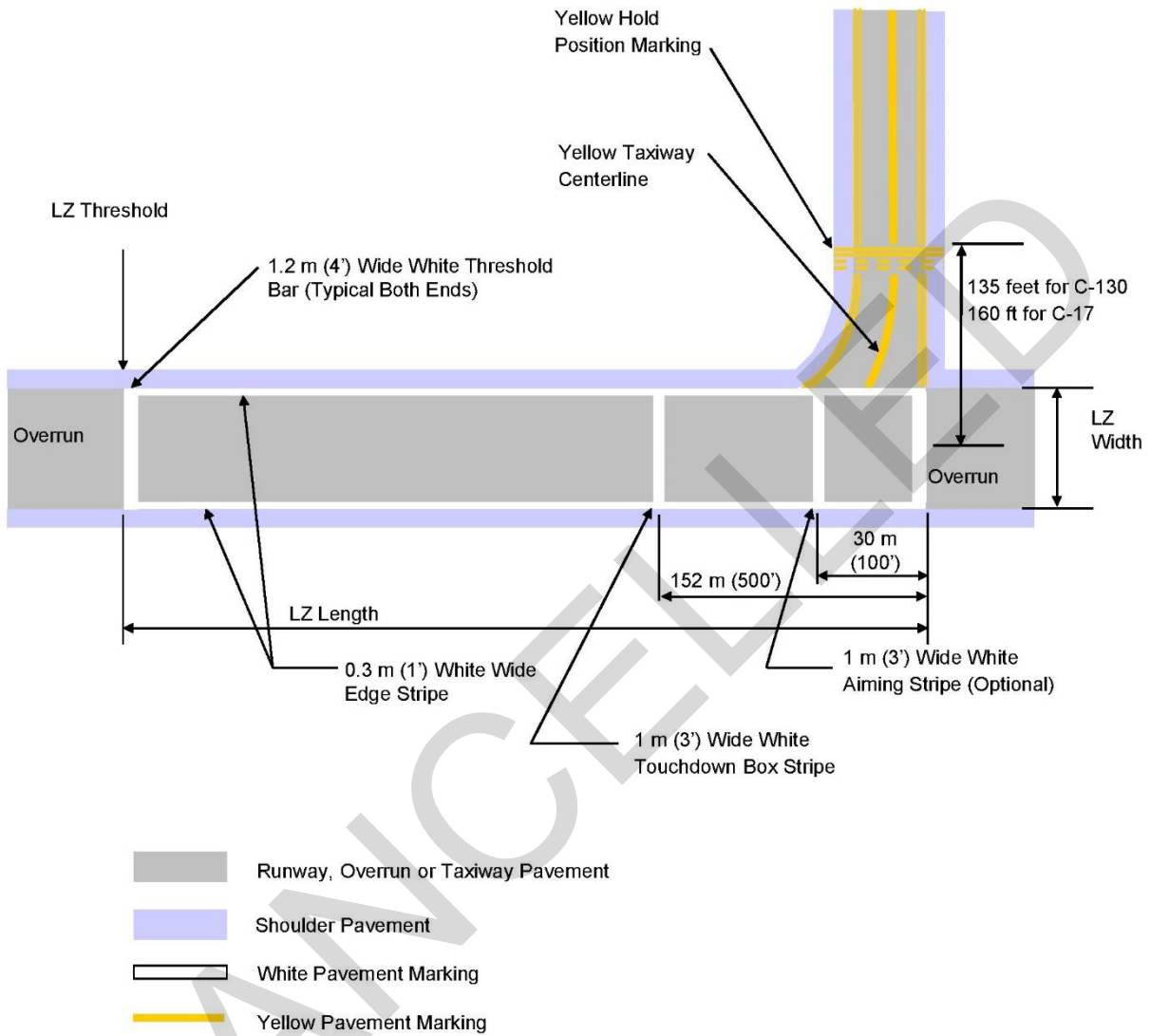
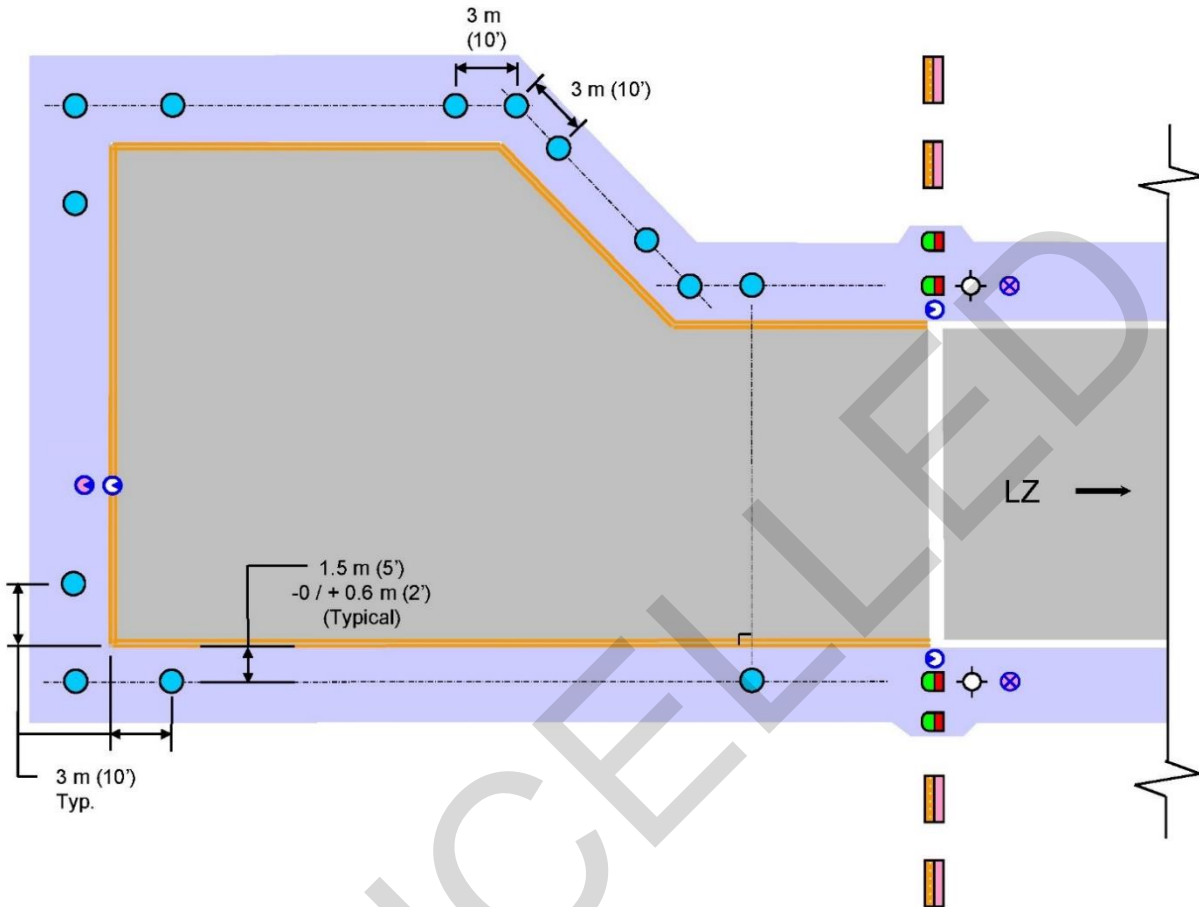















Figure 7-12. Typical Turnaround Marking and Lighting Plan



**LEGEND**

- |   |  |   |   |
|---|--|---|---|
|  | LZ Edge Light with Split Green/Red Lens                                      |  | Runway/Overrun Pavement                               |
|  | LZ Edge Light with White Lens for AMP-3                                      |  | Shoulder Pavement                                     |
|  | Covered Infrared Runway Edge Light for AMP-3                                 |  | Taxiway/Turnaround Edge Stripe, Dual 6" Yellow Stripe |
|  | Flashing Strobe Light  |  | LZ Edge or Threshold Stripe                           |
|  | Covered Infrared Flashing Strobe Light for AMP-3                             |  | Layout Line   |
|  | Taxiway Edge Light, Blue Lens  |  | 90-degree Layout Angle                                |
|  | Airfield Marking Panel for Bi-Directional Operations, Orange/Cerise Surfaces |   |   |

Notes:

1. See text and Figure 7-14 for layout dimensions.
2. LZ is configured for bi-directional operations.
3. All taxiway lights shall be equidistant from taxiway/turnaround edge. Design tolerance is 1.5 m (5') - 0 / + 0.6 m (2').

Figure 7-13. Typical Bi-Directional Runway/Taxiway Marking and Lighting Layout

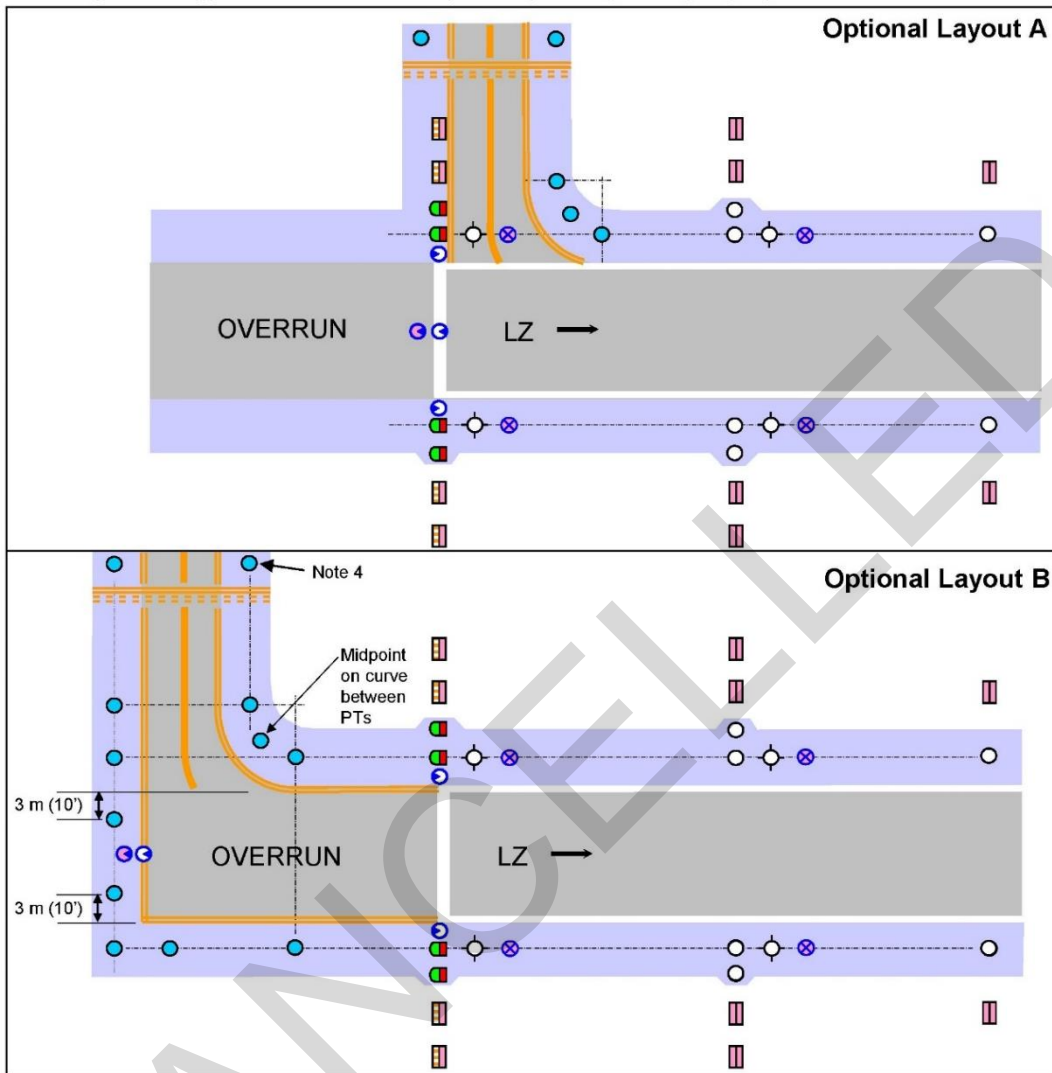

**LEGEND**

- |  |   |  |  |
|--|---|--|--|
|  | LZ Edge Light with Split Green/Red Lens for AMP-1 |  | Airfield Marking Panel for Bi-Directional Operations, Orange/Cerise Surfaces |
|  | LZ Edge Light with White Lens for AMP-1           |  | Airfield Marking Panel for Bi-Directional Operations, Cerise/Cerise Surfaces |
|  | LZ Edge Light with White Lens for AMP-3           |  | Runway/Overrun Pavement  |
|  | Covert Infrared Runway Edge Light for AMP-3       |  | Shoulder Pavement  |
|  | Flashing Strobe Light                             |  | Taxiway/Turnaround Edge Stripe, Dual 6" Yellow Stripe                        |
|  | Covert Infrared Flashing Strobe Light for AMP-3   |  | Taxiway Centerline Stripe  |
|  | Taxiway Edge Light with Blue Lens                 |  | LZ Edge Stripe   |

**Notes:**

1. See text and Figure 7-14 for layout dimensions.
2. LZ is marked and lighted for bi-directional operations.
3. All taxiway lights shall be equidistant from taxiway/turnaround edge. Design tolerance is 1.5 m (5') - 0 / + 0.6 m (2').
4. Locate taxiway lights behind the hold line according to UFC3-535-01, but no more than 60 m (200') from the point of tangency.

Figure 7-14. Light and Marker Panel Layout Detail on a Landing Zone with Combination AMP-1, AMP-3 (Visual Spectrum) and Infrared AMP-3

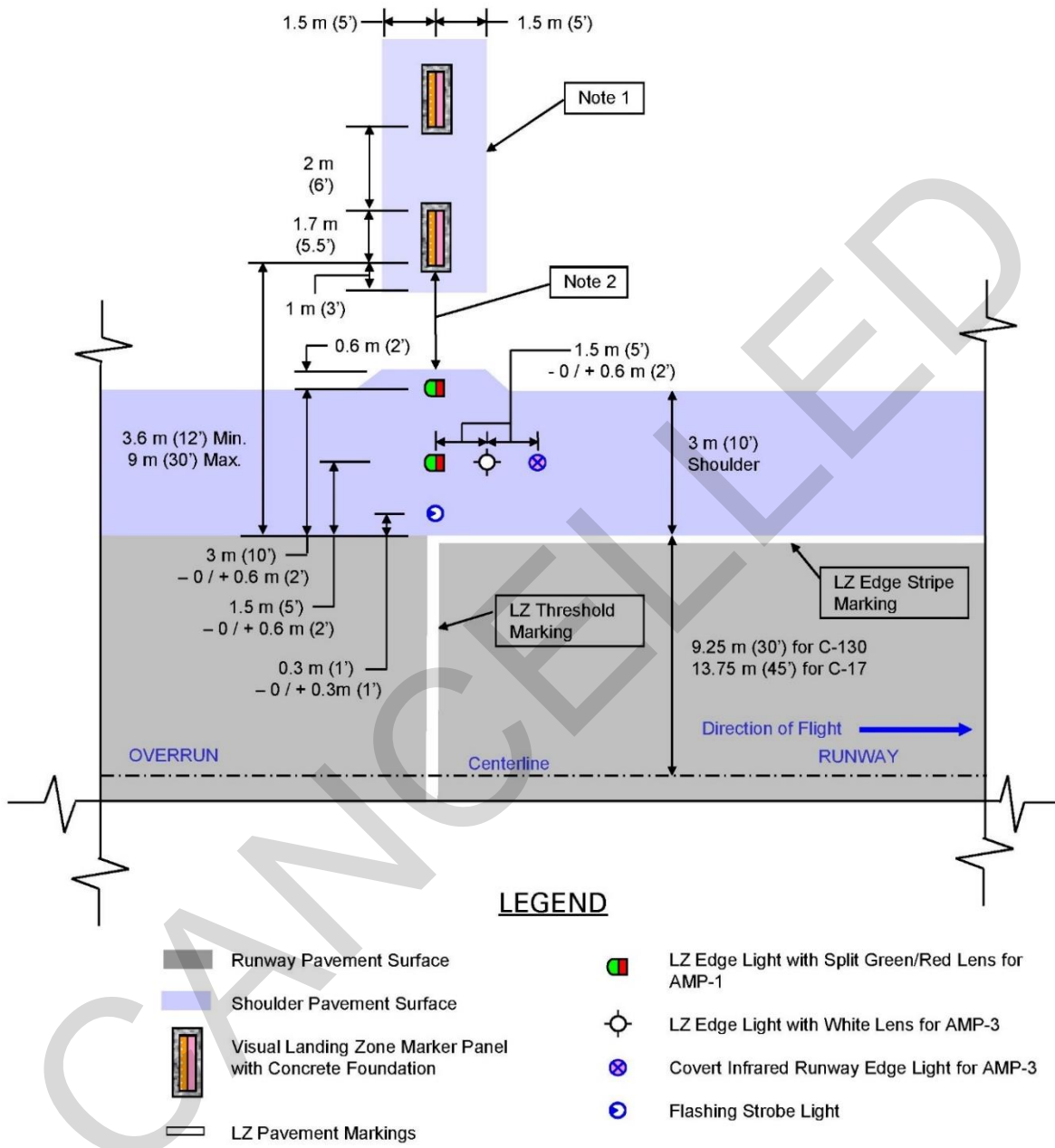

Notes:

1. Paved pad surrounding sign bases is recommended to eliminate need for mowing close to and between signs.
2. If gap between paved shoulder and sign foundation is less than 2.4 m (8'), pave entire gap.
3. LZ Edge lights must be on the same longitudinal alignment throughout the length of the LZ. Pairs of lights should be perpendicular and equidistant from the centerline.
4. All LZ lights should be located at least 0.6 m (2') from PCC pavement joints.
5. Minimum 1.2 m (4') spacing between Flashing Strobe and inboard Edge Light. Minimum 1.5 m (5') spacing between edge light pairs.



#### **7-12.4 LZ Markings on Class A or B Runways.**

In some cases, it may be desirable to use a standard full-length runway for LZ training operations. For this purpose, the LZ marking schemes illustrated in Figures 7-16 and 7-17 should be applied, subject to the following conditions.

##### **7-12.4.1 LZ Marking Dimensions.**

Non-reflective white markings, 3 meters (10 feet) by 1.7 meters (5.5 feet) are applied in the same pattern as VLZMP for the AMP-3 configuration.

##### **7-12.4.2 LZ Location on the Runway.**

When possible, the LZ threshold should be sited so the LZ touchdown area is within the first 305 meters (1000 feet) of the runway pavement, and the 91-meter (300-foot) LZ overrun falls on the runway surface (not overrun). This will ensure that aircraft loads are concentrated on the portion of the runway designed for heavier loads. As described in paragraph 7-11.6.2, siting the LZ threshold 91 meters (300 feet) from the runway threshold will accomplish this objective.

##### **7-12.4.3 LZ Marking Conflicts with Standard Runway Markings.**

The LZ will be sited so the markings do not conflict with threshold markings, runway designation markings, touchdown zone markings, or fixed distance markings. An ideal location for the LZ threshold is 91 meters (300 feet) from the runway threshold. This will position the LZ markings in the gaps between the standard runway markings. See UFC 3-260-04 for standard airfield pavement marking criteria. When there is a conflict with Standard Runway Markings the Standard Runway Marking will take precedence. Any deviation from the standard runway marking requires a waiver to criteria.

Figure 7-15. AMP-3 Lighting and Marking Scheme for LZ Superimposed on Class A or B Runway

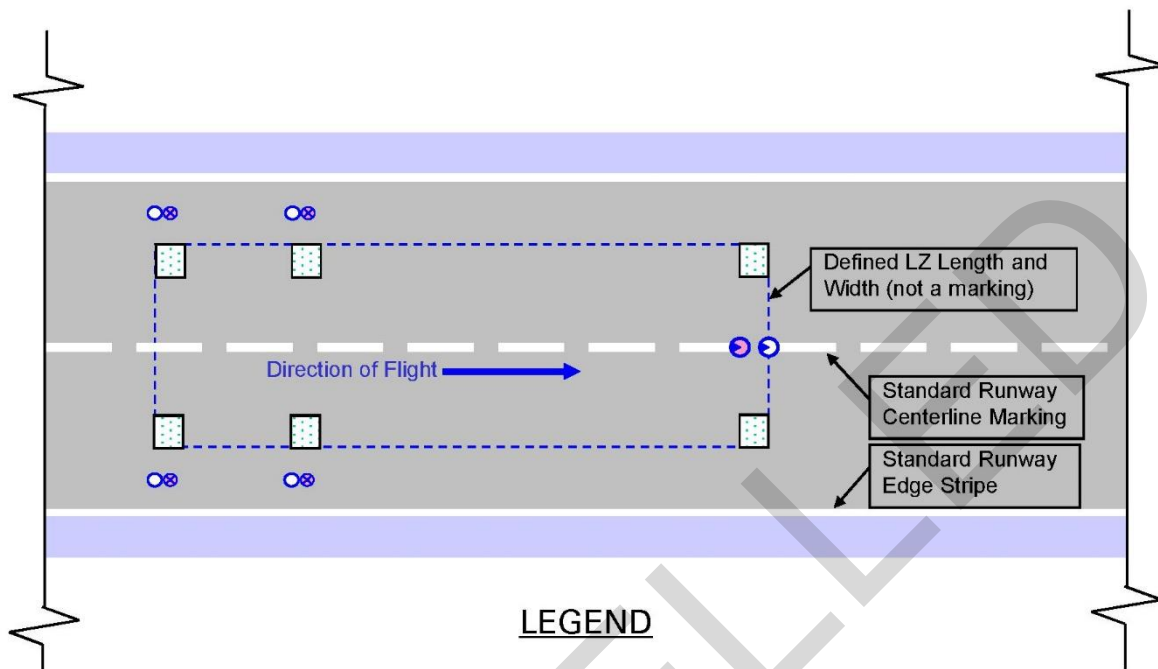

**LEGEND**

Runway Pavement Surface	Shoulder Pavement Surface
Non-reflective White Pavement Marking	White Runway Semi-Flush Edge Light
Standard Reflective White Runway Centerline and Edge Stripe Markings	Infrared Semi-Flush Edge Light
	Flashing White Semi-Flush Strobe Light
	Flashing Infrared Semi-Flush Strobe Light

Notes:

1. LZ Pavement Markings should be installed with the inside edge aligned with the edge of the LZ. The back edge should be aligned with the measurement from the threshold. Markings should be 3.0 m (10') long (parallel to runway centerline) and 1.7 m (5.5') wide.
2. If the flashing strobe light is not semi-flush, install at the end of the usable runway.
3. See Figure 7-16 and 7-17 for detailed layout of lights and markings.

Figure 7-16. AMP-3 Visible and Infrared Lighting and Marking Layout Detail for LZ Superimposed on Class A Runway

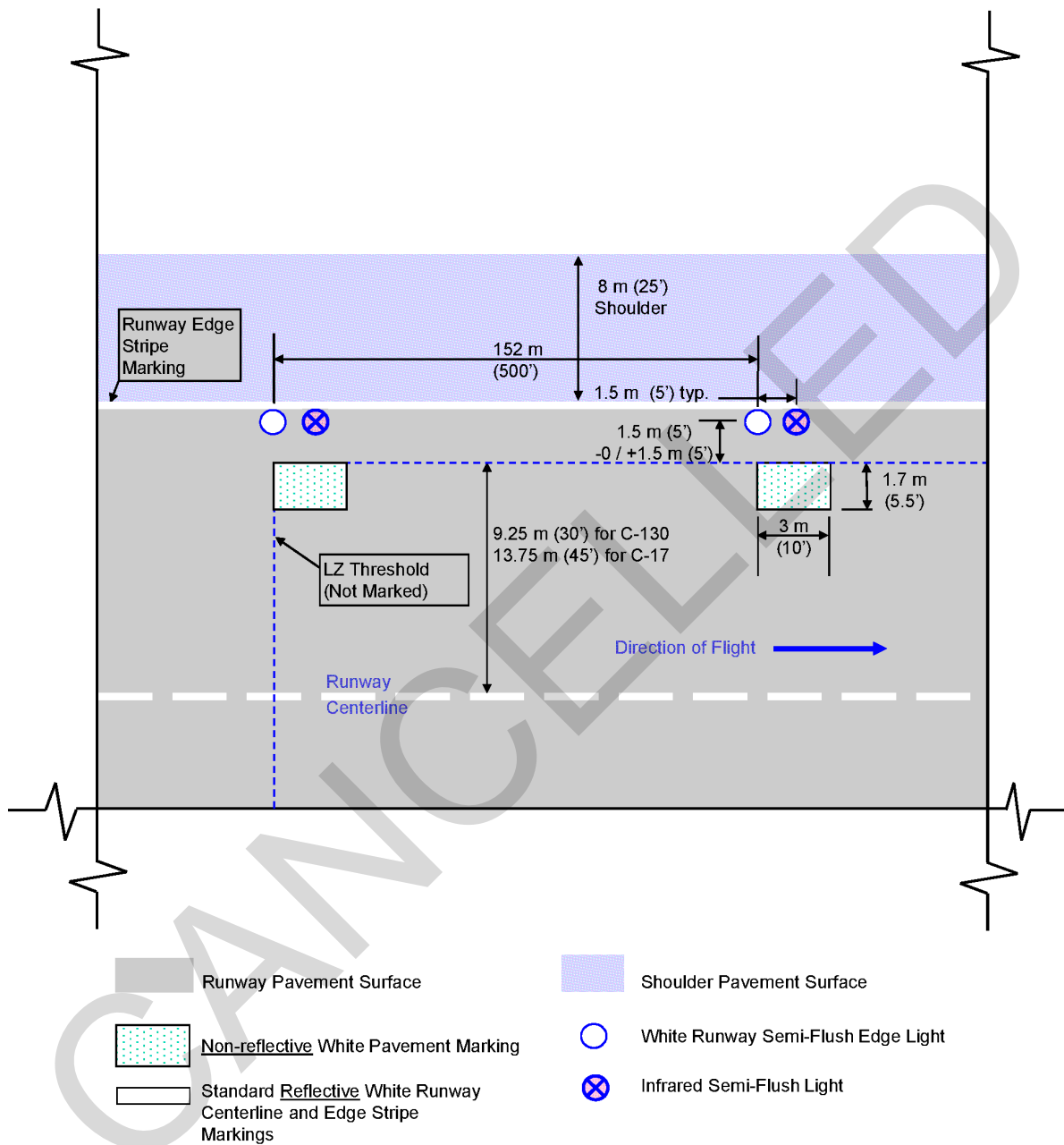

Notes:

1. LZ threshold should be sited so that conflicts with standard lights and markings are avoided.
2. All LZ lights should be located at least 0.6 m (2') from PCC pavement joints.
3. See paragraphs 7-12.6 and 7-13.4 for additional details.
4. Ensure paint markings are not applied to LZ light fixtures.
5. Visible and Infrared light order may be reversed.

Figure 7-17. AMP-3 Visible and Infrared Lighting and Marking Layout Detail for LZ Superimposed on Class B Runway

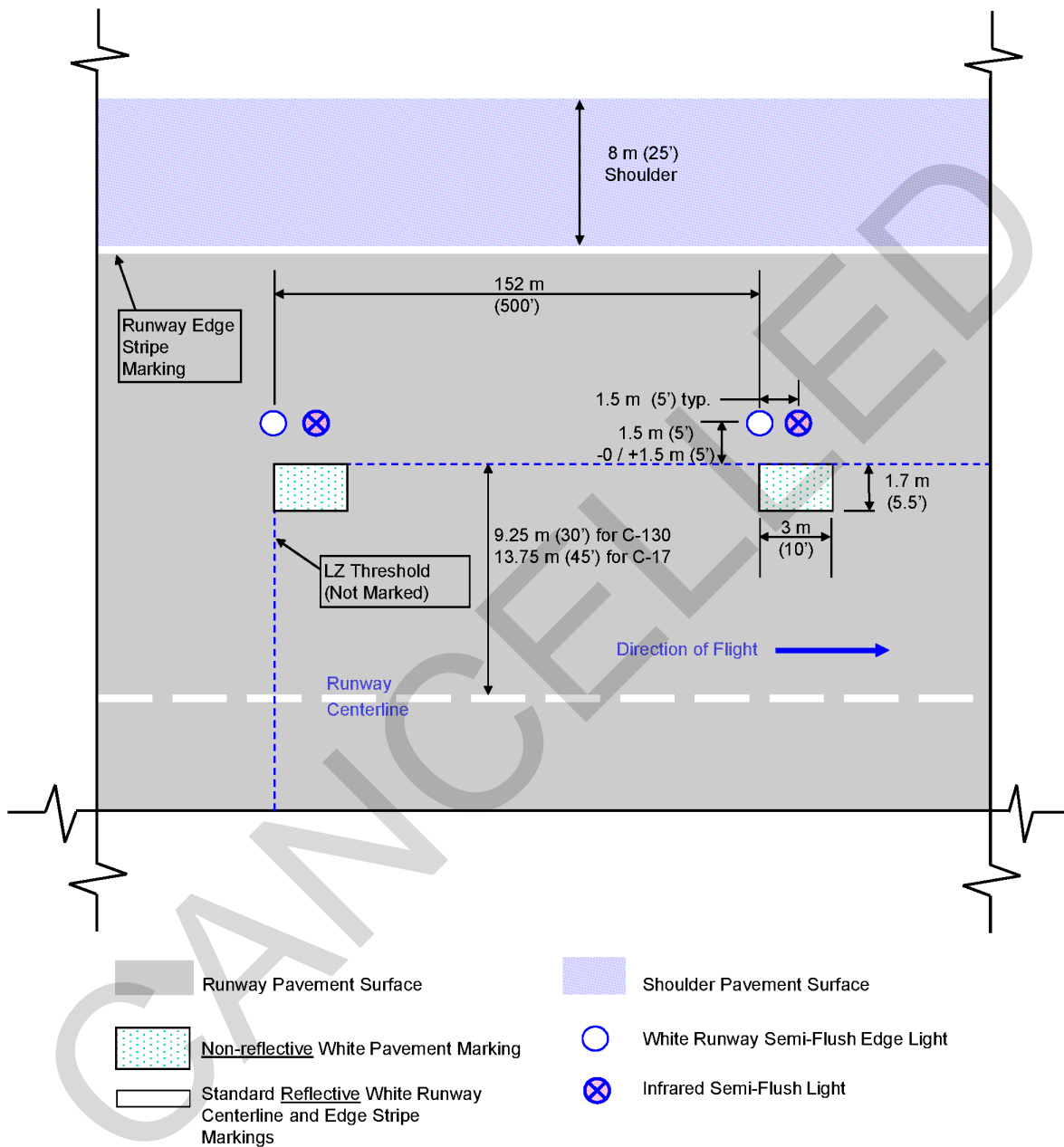

Notes:

1. LZ threshold should be sited so that conflicts with standard lights and markings are avoided.
2. All LZ lights should be located at least 0.6 m (2') from PCC pavement joints.
3. See paragraphs 7-12.6 and 7-13.4 for additional details.
4. Ensure paint markings are not applied to LZ light fixtures.
5. Visible and Infrared light order may be reversed.

## CHAPTER 8 FIXED-WING SHORT TAKEOFF AND VERTICAL LANDING (STOVL) FACILITIES

### 8-1 GENERAL INFORMATION.

This chapter discusses the airspace requirements, physical construction criteria, and general usage considerations for four types of STOVL facilities: LHD (amphibious assault ship) training facility, Vertical Landing (VL) pad, Forward Operating Base (FOB) facility, Tilt-Rotor Outlying Landing Field (OLF).

#### 8-1.1 Chapter Organization.

Paragraphs 8-1, 8-2 and 8-3 provide general background information, definitions, and planning considerations that apply to all fixed-wing STOVL facilities. Paragraphs 8-4 through 8-7 provide specific requirements for designing the four types of STOVL facilities (LHD, VL Pad, FOB and OLF), including geometry, airspace, marking, lighting and pavement surface type.

#### 8-1.2 Facility Concepts.

The STOVL facilities will support the training of F-35B and V-22 aircrew and ground personnel prior to ship-borne deployments and expeditionary operational environments. The smaller size of the amphibious assault ship (LHD) flight deck, as compared to the aircraft carrier (CVN) flight deck, and difference in landing type is significant enough to require its own dedicated training facility.

#### 8-1.3 Basis of Design.

Criteria in this chapter were developed from the basis of design aircraft listed below; however, this is not intended to prohibit operations of other aircraft on these facilities. Each using aircraft, including the basis of design aircraft, must evaluate the facility for operational suitability.

Facility Type	Basis of Design Aircraft
LHD	F-35B and V-22 (LHD 5 ship deck)
FOB	F-35B
VL Pad	F-35B
Tilt-Rotor OLF	V-22

#### 8-1.4 Background.

Due to the unique training requirements for F-35B and V-22 Flying Training Squadrons (FTSs) and the need for Operational Squadrons to train pilots for the rigors of ship and

forward base deployments, those squadrons will need land-based STOVL specific facilities. This chapter addresses the criteria needed to design and construct land-based STOVL specific facilities and the imaginary surfaces necessary to support the STOVL facilities. The criteria presented in this document was developed from two main sources: Air Force ETL 14-4 “*Vertical Landing Zone (VLZ) and Other Airfield Pavement Design and Construction Using High Temperature Concrete*” dated 18 Aug 2014 and “F-35 Lightning II STOVL Airfield Facilities and Airspace Criteria Engineering Technical Letter (ETL), Document No: 2PSS00040, Rev 1” dated 30 July 2010. Criteria has been incorporated including changes, corrections, and other modifications resolving problems with original content. Non-applicable content has been omitted but may still be a useful reference to those seeking more background.

## **8-2 DEFINITIONS.**

Only terms unique to this chapter are defined in this chapter. See the Glossary at the end of this UFC for general definitions.

### **8-2.1 Accident Potential Zone–STOVL (APZ-STOVL).**

The land use control area beyond the clear zone of a STOVL that possesses a significant potential for accidents; therefore, land use is a concern.

### **8-2.2 Approach Clearance Surface.**

An imaginary surface that is an inclined plane or combined incline and horizontal planes arranged symmetrically about the extended runway centerline covering the approach path for a directional STOVL facility. See Approach-Departure Clearance Surface for further detail.

### **8-2.3 Apron-STOVL.**

A defined area on a STOVL facility intended to accommodate aircraft for loading or unloading passengers or cargo, refueling, parking, or maintenance. Aprons are sized to accommodate the mission.

### **8-2.4 Clear Zone-STOVL.**

A surface on the ground or water, beginning at the runway threshold and symmetrical about the extended runway centerline, graded to protect aircraft operations and in which only properly sited NAVAIDs are allowed.

### **8-2.5 Departure Clearance Surface (DCS)-STOVL.**

An imaginary surface that is an inclined plane or combined incline and horizontal planes arranged symmetrically about the extended runway centerline covering the departure path for a directional STOVL facility. See Approach-Departure Clearance Surface for further detail.

### **8-2.6 Forward Operating Base (FOB) STOVL Facility.**

A FOB STOVL facility is one dedicated to short takeoff (STO) and rolling vertical landing (RVL) operations. These facilities have shorter and narrower runway dimensions than main airfields, and represent a mission oriented basing posture. The STO and RVL operations are performed to minimize ground roll and facility footprint.

### **8-2.7 Foul Line.**

On an LHD STOVL Facility, a painted line that defines the edge of surface usable for takeoff and landing operations. The line is parallel to the centerline (tramline) and offset towards the LSO Tower. It consists of an alternating red and white stripe, with black outline.

### **8-2.8 High Temperature Concrete.**

Portland cement concrete mixtures using expanded aggregates (also known as lightweight aggregates) or approved traprock sources are referred to as High Temperature Concrete (HTC). In this chapter, HTC only refers to high temperature concrete that meets the requirements of UFGS 32 13 13.43. HTC can be a specific formulation to support only V-22 aircraft, or V-22 and F-35B aircraft.

### **8-2.9 Imaginary Surfaces-STOVL.**

Surfaces in space established around a STOVL Facility in relation to runways, helipads, or helicopter runways, and designed to define the protected airspace around the airfield. The imaginary surfaces for STOVL facilities are the primary surface, transitional surface, inner horizontal surface and ADCS.

### **8-2.10 LHD STOVL Facility.**

A full size simulated land-based LHD ship flight deck used for field carrier landing practice (FCLP) consisting of short takeoff and vertical landing.

### **8-2.11 Primary Surface-STOVL.**

An imaginary surface symmetrically centered on the STOVL Facility. The elevation of any point on the primary surface is the same as the elevation of the nearest point on the runway centerline or extended runway centerline.

### **8-2.12 Runway Centerline-STOVL.**

The line extending the full length of the runway surface describing the center of the runway. For the LHD STOVL facility it is the tram line.

### **8-2.13 Safety Zones.**

Safety zones are provided to prevent the erosion of graded surfaces by jet blast from aircraft transitioning to and from the STOVL facility.

#### **8-2.14 STOVL Facility.**

A STOVL facility is a takeoff and/or landing facility dedicated to short takeoff and vertical landing operations. For the purposes of this chapter there are four different types of STOVL facilities; LHD STOVL facility, Forward Operating Base (FOB) STOVL facility, Vertical Landing (VL) pad and Tilt-Rotor Outlying Landing Field (OLF).

#### **8-2.15 STOVL Pavement Surface Types.**

Several different surface types are required or recommended for STOVL Facilities because of the high temperature environment imposed by operations. For areas where F-35B vertical landings will occur, the surface will be constructed with High Temperature Concrete (HTC). See UFGS 32 13 13.43 and contact service-specific subject matter experts' guidance on HTC materials, mix design and construction techniques. Special considerations are needed for areas surrounding the landing surface and areas used for short takeoff operations. Four different types of pavement may be used on STOVL facilities.

- Continuously Reinforced High Temperature Concrete (CRHTC).
- Plain Jointed High Temperature Concrete (PJHTC)
- Plain Jointed Portland Cement Concrete (PJPCC)
- Hot Mix Asphalt (HMA)

#### **8-2.16 Vertical Landing Pad (VL Pad).**

Vertical landing pad is a paved surface of fixed dimension that affords a landing location for fixed-wing STOVL aircraft.

### **8-3 STOVL FACILITY PLANNING CONSIDERATIONS.**

The landing and takeoff design considerations for a STOVL facilities will be directed to fulfill the requirements for the STOVL aircraft to include mission requirements, expected type and volume of air traffic, VFR and simulated IFR traffic patterns, runway (deck) length, runway orientation required by local wind conditions, local terrain, restrictions due to airspace obstacles or the surrounding community, noise impact, and aircraft accident potential. When planning to construct a new runway (deck) or reconstruct an existing runway (deck), in addition to local permitting requirements, file FAA Form 7480-1 in accordance with FAA Order 7400.2.

#### **8-3.1 Site Conditions.**

When planning the layout of a permanent STOVL, facility site conditions beyond safety of aircraft-related operations must be considered. These include land use compatibility



with clear zones, primary surfaces, exclusion areas, impacts to existing instrument procedures and ADCS, and with existing and future use of the areas that surround the STOVL facility. In planning a STOVL facility, consider the use and zoning of surrounding land for compatibility with aircraft operations. The purpose is to protect the operational capability of the STOVL facility and prevent incompatible development, thus minimizing health and safety concerns in areas subject to high noise and accident potential resulting from frequent aircraft over-flights. The minimum criteria in this chapter establish standards for a safe environment for aircraft and ground operations. The goal is to provide a STOVL environment that provides the greatest margin of safety and compatibility for personnel, equipment, and facilities. Review the instructions and regulations for each Service and 32 CFR 989, *Environmental Impact Analysis Process (EIAP)* for guidance on the Environmental Impact Analysis Process.

### **8-3.2 Future Development (Land or Aircraft Technology).**

Adequate land for future aviation growth must be considered when planning a STOVL facility. The facility should be compatible with the existing installation plan. Potential instrument flight rules (IFR) capability will require additional criteria considerations.

### **8-3.3 Prohibited Land Uses.**

DoD and Service specific AICUZ directives govern land uses within the exclusion area, clear zone, and APZ. These restrictions are described in Tables 8-3, 8-6, 8-9 and 8-12.

### **8-3.4 APZs not on DoD Property.**

APZs that are not on DoD property may require easements to control development and remove vegetation that may violate the ADCS. The need must be determined on a case-by-case basis.

## **8-3.5 SITING CONSIDERATIONS.**

### **8-3.5.1 Site Considerations.**

Site considerations include topography, vegetative cover, existing construction, weather elements, local wind conditions soil conditions, flood hazard, natural and man-made obstructions, adjacent land use, and availability of usable airspace, accessibility of roads and utilities, and potential for expansion capability. Applicable clearances, including separation distances, APZ, and imaginary surfaces must be. Siting approval must be obtained as part of planning and programming prior to any construction of new facilities or installation of equipment, including above ground infrastructure such as lights, pumps, etc. To minimize crosswinds, the strength, direction, and frequency of local winds must be considered when orienting a VL Pad. The potential for encroachment and effects of noise on the local community must also be considered.

### **8-3.5.2 Obstructions.**

For training STOVL facilities, it is preferable to position the runway within an airfield environment to take advantage of existing runway and taxiway clearance areas. To maximize the training environment, the STOVL facility ADCS should be placed parallel to existing runway ADCS and with adequate separation to support parallel runway operations.

### **8-3.5.3 Orientation.**

Runway orientation is the key to a safe, efficient, and usable aviation facility. Orientation is based on an analysis of wind data, terrain, local development, operational procedures, and other pertinent data. Procedures for analysis of wind data to determine wind orientation are discussed further in Appendix B, Section 4. Because an LHD runway is uni-directional, ensure the bow is oriented into the predominant wind direction.

### **8-3.5.4 Restricted Airspace.**

Airspace through which aircraft operations are restricted, and possibly prohibited, is shown on sectional and local aeronautical charts. Runways should be oriented so that their approach and departure patterns do not encroach on restricted areas.

### **8-3.5.5 Noise Analysis.**

The positioning of a STOVL facility must take into account noise levels on existing facilities, local communities, and noise-sensitive areas. Air Installations Compatible Use Zones (AICUZ) and Installation Compatible Use Zone (ICUZ) are programs initiated to implement Federal laws concerning land compatibility from the perspective of environmental noise impacts. The ICUZ program is the Army's extension of the AICUZ program, which was initiated by the DoD and undertaken primarily by Air Force and Navy aviation facilities. Studies under these programs establish noise abatement measures that help to eliminate or reduce the intensity of noise from its sources, and provide land use management measures for areas near the noise source.

#### **8-3.5.5.1 Analysis.**

Due to the widely varied aircraft, aircraft power plants, airfield traffic volume, and airfield traffic patterns, aviation noise at installations depends on both aircraft types and operational procedures. Aircraft noise studies should be prepared for aviation facilities to quantify noise levels and possible adverse environmental effects, ensure that noise reduction procedures are investigated, and plan land for uses that are compatible with higher levels of noise. While many areas of an aviation facility tolerate higher noise levels, many aviation landside facilities and adjoining properties do not. Noise contours developed under the AICUZ and ICUZ studies are used to graphically illustrate noise levels and provide a basis for land use management and impact mitigation. The primary means of noise assessment is mathematical modeling and computer simulation. Guidance regarding when to conduct noise studies is contained in the environmental directive for each Service.

### **8-3.5.6 Built-Up Areas.**

Airfield sites and runway alignment will be selected and operational procedures adopted that will least impact local inhabitants. Additional guidance for facilities is found in DoDI 4165.57.

### **8-3.5.7 Clear Zones.**

The purpose of the clear zone is to protect the safety of flight and safety of people on the ground. The entire clear zone area is a land use control area intended to protect people both flight safety and property on the ground. Land use for the clear zone area for STOVL facilities corresponds to the clear zone land use criteria for fixed-wing airfields as defined in DoD AICUZ and Service-specific standards and as discussed in Chapter 3.

### **8-3.5.8 Explosives.**

#### **8-3.5.8.1 General.**

All explosives locations, including locations where aircraft loaded with explosives are parked must be sited in accordance with DoD Standard 6055.9 and applicable Service explosives safety regulations. Explosives site plans, approved through command channels to DoD, ensure that minimal acceptable risk exists between explosives and other airfield resources. To prevent inadvertent ignition of electro-explosive devices (EED), separation between sources of electromagnetic radiation is required. Separation distances must be according to safe separation distance criteria. Grounding requirements, lightning protection, and further considerations for explosives on aircraft are presented below. Where explosives or hazardous materials are handled at or near aircraft, safety and separation clearances are required. The clearances are based on quantity-distance criteria.

#### **8-3.5.8.2 Separation Distance Requirements.**

Minimum standards for separating explosives (explosion separation distances and quantity-distance [Q-D] relationships) -loaded aircraft from runways, taxiways, inhabited buildings, and other loaded aircraft are established in AR 385-10 for the Army; AFMAN 91-201 for the Air Force; and NAVSEA OP-5 and NAVAIR 16-1-529 for the Navy and Marine Corps. These documents also establish Q-D relationships for separating related and unrelated potential explosion site (PES) and explosive and non-explosive exposed sites.

#### **8-3.5.8.3 Prohibited Zones.**

Explosives, explosive facilities, and parked explosives-loaded aircraft (or those being loaded or unloaded) are prohibited from being located in Accident Potential Zones (APZ) I and II and clear zones as set forth in AR 385-10; DAPAM 385-64, Chapter 5; AFMAN 91-201; and AFI 32-7063.

### **8-3.6 FAA Requirements.**

When a new STOVL facility is sited, in addition to local permitting requirements, file FAA Form 7480-1, *Notice of Landing Area Proposal*, in accordance with FAA Order 7400.2, *Procedures for Handling Airspace Matters*. Submit an FAA Form 7460-1, *Notice of Proposed Construction or Alteration*, for any above ground structures or modifications to existing airfields associated with the STOVL facilities.

### **8-3.7 Airspace Approval**

Construction of new airfields, heliports, helipad or hoverpoints, or modifications to existing facilities affecting the use of airspace or changes in aircraft densities will be in conformance with JO 7400.2 (Procedures For Handling Airspace Matters).

### **8-3.8 Environmental.**

Development of an aviation facility, including expansion of an existing aviation facility, requires compliance with a variety of laws, regulations, and policies. The National Environmental Policy Act (NEPA) requires all Federal agencies to consider the potential environmental impacts of certain proposed projects and activities, as directed by DoD Directive (DoDD) 6050.7. Implementation of these regulations is defined for each Service in these documents: Army: AR 200-1; Air Force: Title 32, Code of Federal Regulations, Part 989 (32 CFR 989); and Navy and Marine Corps: OPNAVINST 5090.1B (MCO 5090.2). Four broad categories of environmental review for a proposed action exist. The decision to conduct one study or another depends on the type of project and the potential consequences of a project to various environmental categories. Criteria for determining which type of study should be undertaken are defined in the environmental directives and regulations for each Service. Environmental studies should be prepared and reviewed locally. When additional assistance or guidance is necessary, this support may be obtained through various agencies such as the US Army Air Traffic Services Command (AFAT-ATC-CB), the US Army Corps of Engineers Transportation Systems Center (COE TSC), the US Army Corps of Engineers District Offices, NAVFAC Headquarters, and the Air Force Civil Engineer Center (HQ AFCEC).

### **8-3.9 Taxiway Connections.**

Taxiways provide for ground movement of fixed- and rotary-wing aircraft. Taxiways connect the runways of the airfield with the parking and maintenance areas and provide access to hangars, parking aprons, and landing pads. Chapter 5 presents design standards and considerations for fixed- and rotary-wing taxiways.

#### **8-3.9.1 Basic.**

A basic taxiway layout provides low-volume access to single facility for a single purpose. For example, a single taxiway connecting a vertical landing pad to a main airfield parking apron or ramp supports the recovery of aircraft directly to the parking apron.

### **8-3.9.2 Parallel Taxiway.**

A taxiway parallel for the length of the runway or STOVL facility, with connectors to the ends and the parking apron, provides multiple options for ground movement of aircraft.

### **8-3.9.3 Layout.**

These considerations should be addressed when planning and locating taxiways to connect a STOVL facility to existing airfield infrastructure. Looking at our previous example, if the vertical landing pad is supported with a second taxiway departing and arriving traffic or multiple recovery aircraft can share the same STOVL facility.

#### **8-3.9.3.1 Efficiency.**

STOVL facility efficiency is enhanced by planning for multiple ground movement paths between the apron/fuel pits and the STOVL facility. Plans for aircraft movement in both directions should be included to support recovery of last landing aircraft and as the next evolution positions to begin their period of instruction.

#### **8-3.9.3.2 Direct Access.**

Taxiways should provide as direct an access as possible from the STOVL facility to the parking apron or fuel pits. The time spent taxiing the aircraft between training flights or STOVL training evolutions will directly affect the number of pilots trained during any given training period.

#### **8-3.9.3.3 Simple Taxi Routes.**

A sufficient number of taxiways should be provided to prevent complicated taxi routes or multiple hold points to give way to other aircraft. This consideration is magnified when flights of multiple aircraft are taxiing for departure or recovery. These flights sprawl and their taxi interval becomes extended complicating the movement of aircraft.

#### **8-3.9.3.4 Delay Prevention.**

A sufficient number of taxiways should be provided to prevent capacity delays that may result when one taxiway must service more than one STOVL Facility or multiple aircraft are planned to use the same STOVL facility. For example, if no parallel taxiway is available for aircraft using a FOB STOVL facility then only one aircraft at a time will be able to use the facility, because back taxiing on the runway will prohibit its use by a second aircraft.

### **8-3.9.4 Taxiway Shoulders.**

Shoulders are provided along a taxiway to allow aircraft to recover if they leave the paved taxiway. Paved shoulders, also, prevent erosion caused by jet blast, support a potential aircraft that breaches the taxiway, support vehicular traffic, and reduce maintenance of unpaved shoulder areas. The shoulder for fixed-wing taxiways to

support a STOVL facility should be paved to the maximum extent possible. Follow Table 5-1 for widths, slopes and grading requirements.

### **8-3.9.5 Aircraft Movement.**

As can be seen from the description of the various factors going into taxiway design and layout, the potential exists to define the success or failure of a STOVL facility by the supporting taxiway structure. STOVL operations by definition involve a large number of takeoffs and landings as compared to normal T&R training events. This increased number of takeoffs and landings may or may not involve repositioning, ground loiter time, or a combination of both. Any delay between landing and subsequent takeoff will directly impact the number of aircraft the facility can support. Actions taken by planners and engineering to account for expected delays and provide movement options for aircraft on the ground will keep the STOVL facility deck clear of aircraft or other traffic and go a long way towards ensuring successful operations.

## **8-4 LHD STOVL FACILITIES.**

### **8-4.1 LHD Concept.**

STOVL carrier deployment training historically has incorporated the use of a full scale land-based LHD STOVL facility to include a Landing Signal Officer (LSO) tower, or V/STOL optical landing system (OLS), and Hover Position Indicator (HPI). The size and supporting structure of these facilities has afforded deploying forces the opportunity to train on the simulated LHD deck with significant flight deck realism. Training evolutions typically involve the pilots and LSOs, with a primary focus on practicing shipboard vertical landings followed by Short Take-Offs (STOs) under the supervision of a Launch Officer (LO). Additionally, these flight operations have included LSO under-training to train as launch officers, squadron personnel requiring flight deck familiarization, and the integration of ship's personnel before actual operations afloat. The training benefits to the aircrew, LSO/LO and flight deck personnel are substantial, as they are taught to perceive the simulated flight deck as the actual deck. This realism affords them the opportunity to continue familiarization training beyond the simulator and builds on the training progression needed prior to deployment. VFR flight operations to and from the land-based facility will be assumed throughout this Chapter.

As stated in Paragraph 8-1.3, the basis of design shown in this UFC for an LHD facility is the LHD 5 ship deck. The dimensions, lights, and markings are typical for that ship, but new LHD or LHA ship configurations may change. Therefore, designers must determine current requirements at the time of design from:

Naval Air Warfare Center Aircraft Division (NAWCAD)  
Route 547, Mail Stop 596-1  
Joint Base MDL, NJ 08733-5000

Specific offices within NAWCAD are called out in later paragraphs for specific systems guidance.

#### **8-4.2 LHD Standard Drawings.**

NAVFAC Simulated LHD Shipdeck Standard drawings have been developed for this facility type. These include NAVFAC Drawing Numbers 14064429 through 14064452 and are available from the Whole Building Design Guide (<http://www.wbdg.org/ffc/dod/unified-facilities-criteria-ufc/ufc-3-260-01>), where this UFC is posted. Designer of Record must site-adapt, complete, and validate final design for construction. The original concept was developed for F-35B training; however, the design has been adapted to be compatible with V-22 operations also. These modifications include consideration of additional known F-35B operations, potential V-22 operations, lessons learned of pavement extents and materials. Existing facilities constructed prior to these modifications may need to be evaluated if such operational upgrades are desired.

#### **8-4.3 LHD Background.**

The LHD STOVL training facility will support the training of STOVL aircrew and ground personnel prior to ship-borne deployments. The smaller size of the LHD flight deck, as compared to the CVN flight deck, and difference in landing type is significant enough to require its own dedicated training facility.

STOVL carrier deployment training historically has incorporated the use of a full-scale land-based LHD STOVL facility to include a LSO tower, VSTOL optical landing system (OLS), and Hover Position Indicator (HPI). The size and supporting structure of these facilities has afforded deploying forces the opportunity to train on the simulated LHD deck with significant flight deck realism. Training evolutions typically involve the pilots and Landing Signal Officers (LSOs), with a primary focus on practicing ship-board vertical landings (VL) followed by Short Take-Offs (STOs) under the supervision of a Launch Officer (LO). Additionally, these flight operations have included LSO under-training to train as launch officers, squadron personnel requiring flight deck familiarization, and the integration of ship's personnel before actual operations afloat. The training benefits to the aircrew, LSO/LO and flight deck personnel are substantial, as they are taught to perceive the simulated flight deck as the actual deck. This realism affords them the opportunity to continue familiarization training beyond the simulator and builds on the training progression needed prior to deployment. VFR flight operations to and from the land-based facility will be assumed throughout this Chapter. The pilot training requirements for field carrier landing practice (FCLP) have the pilots fly simulated instrument approaches until established on visual final for the STOVL deck. However, these simulated carrier controlled approaches (CCAs) will be flown as self-contained VFR approaches or contact approach to the STOVL deck.

##### **8-4.3.1 Assumptions.**

- LHD criteria in this chapter is based on matching the dimensions, markings and lighting of an LHD 5 ship deck.
- The LHD STOVL facility is a unidirectional facility executing arrival and departures in the same direction.
- Airspace imaginary surfaces are defined for a standalone STOVL facility. When the LHD STOVL facility is collocated with an existing DoD airfield and their respective imaginary surfaces overlap, the most restrictive or lower surface will be utilized to ensure obstacle clearance.
- The imaginary surfaces for the LHD STOVL facility provide obstacle clearance for the F-35B day and night FCLP pattern. The day FCLP pattern altitude defines the inner horizontal surface and transitional area elevations. The night FCLP pattern defines the outer horizontal surface length and elevation, while the simulated IMC carrier controlled approach (CCA) profile defines the approach and departure path requirements. These surface dimensions are presented similar to the existing Class B runway criteria with the following exceptions; (1) the approach-departure paths were separated because the facility is not bi-directional, (2) the approach-departure slope is referenced to the LZ criteria because it provides clearance for the STO and vertical landing/rolling vertical landing (VL/RVL) profile, (3) the approach slope begins at the aft edge of the deck due to the VL approach profile, (4) the approach and departure horizontal distances terminate at the outer distance of the outer horizontal surface because this distance supports the simulated IFR CCA pattern, (5) inner surface radius corresponds with the approach-departure slope for the inner horizontal surface elevation, and (6) the width of the primary surface is reduced because all recoveries will be conducted under VMC and the close supervision of a Landing Signal Officer.
- The LHD STOVL facility is considered a directional facility with fixed approach and departure directions. These fixed approach and departure paths resulted in separate imaginary surface definition to minimize impact to surrounding environment and airfield infrastructure.
- A 300-foot primary surface width is used for LHD STOVL facilities because all recoveries will be conducted under Visual Meteorological Condition (VMC) and the close supervision of a Landing Signal Officer.
- Cross-axial approaches will not be conducted to the land based LHD STOVL facility.

#### **8-4.4 LHD Geometry**

##### **8-4.4.1 Deck, Overrun and Safety Zone Descriptions.**

Figures 8-1 through 8-13, and Table 8-1 provide dimensional criteria for layout and design of the LHD simulated ship flight deck, overruns, and safety zones. Safety zones are provided to prevent erosion of graded surfaces by jet blast from aircraft transitioning



to and from the STOVL facility. Each zone or surface contains a brief description of its use and reference to where its specific dimension or graphic is located within the document.

#### **8-4.4.2 Deck Length.**

Table 8-1 provides the length of the overall simulated ship flight deck. Ideally the length varies slightly over the width of the simulated ship flight deck to reflect the actual outline of the deck it is designed to simulate.

#### **8-4.4.3 Deck Width.**

Table 8-1 provides the width of the simulated ship flight deck. Ideally the width varies slightly over the length of the simulated ship flight deck to reflect the actual outline of the deck it is designed to simulate.

#### **8-4.4.4 Gradients of Operational Surfaces.**

Gradient constraints are based upon sufficient slope to insure surface water runoff. A uniform slope is preferable to eliminate irregularities between landing gear at touchdown. For this reason the simulated deck surface can be crowned on the foul line or the entire deck surface sloped in one direction away from the LSO tower. Either sloping scheme will provide the pilot with a uniformly sloped surface for touchdown. See Table 8-1. After construction and prior to aircraft operations, each Landing Position will be surveyed on a 10' x 10' grid to determine elevations to the nearest 0.01'. This data will be analyzed using the procedures outlined in DM#315235 "Vertical Landing Pad Certification Requirements and Analysis" to verify the relative smoothness and certify the pads as "Authorized Level". If the pad does not meet the "Authorized Level" requirements, surface diamond grinding will be used to create a smooth surface with a consistent slope. The detailed requirements for conducting a pad levelness survey can be provided by the F-35 JPO. The purpose of the survey is to obtain measurements for analysis to verify that landing spot levelness and flatness complies with F-35B Flight Series Data (FSD). Post construction landing spot survey data should be sent to [Lightning.Support.Team@jsf.mil](mailto:Lightning.Support.Team@jsf.mil) for analysis. Analysis results will be provided to the requestor. Additionally, data, analysis, and results for all landing spots analyzed by the Lightning Support Team (LST) will be retained and archived for future reference; they may be found at DM#315485. Contact the F-35 JPO and Naval Air Surface Warfare Center Aircraft Division (NAWCAD) AR-6.7.8.2 NAVAIR Aviation Shore Facility Integration Branch for additional information on this subject.

#### **8-4.4.5 Forward Safety Zone Length.**

Table 8-1 provides the length of the overrun or forward safety zone. This length is dependent on the short takeoff (STO) profile and the distance from the simulated deck bow where the profile reaches a minimum altitude of 150 ft AGL.

#### **8-4.4.6 Forward Safety Zone Width.**

Table 8-1 provides the width of the overrun or forward safety zone. This width, at a minimum, reflects the width of the simulated flight deck plus a minimum shoulder width of 10 ft on each side (20 ft total). The width of the overrun may neck down or narrow by 50% if desired, however this narrowing of the overrun will be centered on the extended runway centerline or tram line for the simulated flight deck.

#### **8-4.4.7 Shoulder Length.**

Table 8-1 provides the length of the shoulder. This length is dependent on the length of the simulated ship deck and tied into the forward and aft safety zones for one continuous surface.

#### **8-4.4.8 Shoulder Width.**

Table 8-1 provides the width of the left and right shoulders. This width is designed to prevent soil erosion from decelerating aircraft alongside of the simulated flight deck before the aircraft crosses to the assigned landing spot.

#### **8-4.4.9 Approach Safety Zone Length.**

Table 8-1 provides the length of the approach safety zone. This length is dependent on the Field Carrier Landing Practice (FCLP) pattern and corresponds to distance from the aft deck edge where the profile reaches a minimum altitude of 150 ft AGL.

#### **8-4.4.10 Approach Safety Zone Width**

Table 8-1 provides the width of the approach safety zone. This width, at a minimum, reflects the width of the simulated flight deck plus the Left Shoulder or Abeam Safety Zone.

#### **8-4.4.11 Supporting Facilities.**

Several different types of supporting facilities may be adjacent to or connected to the LHD facility, depending on mission requirements. Generally, facilities should be connected on the right (starboard) side of the LHD. Use the appropriate criteria (such as Chapter 5 or 6 for connecting taxiways and aprons) in this UFC or other documents to design supporting facilities, such as:

- Connecting Taxiway
- Parking Apron
- Refueling Systems
- Bathroom
- Airfield Lighting Vault

#### **8-4.5 LHD Separation Distances.**

Table 8-1 provides the minimum separation distances between permanent runways/helipads and the LHD STOVL facility for simultaneous operations. Table 8-1

also provides the minimum separation distances between permanent Class A or Class B Runways and LHD STOVL facility for non-simultaneous operations.

#### **8-4.6 LHD Clear Zones, Imaginary Surfaces, and APZs.**

Applicable clearances and grade controls must be established to provide a reasonable level of safety. Their description and layout are similar to other airfield types and are not unique to the LHD STOVL facility. Each zone or surface contains a brief description of their use and reference to where their specific dimension or graphic is located within the document.

##### **8-4.6.1 Clear Zones.**

Runway clear zones are areas on the ground, located at the ends of each runway. They possess a high potential for accidents, and their use is restricted to be compatible with aircraft operations. Runway clear zones are required for the runway and should be owned or protected under a long-term lease. See Table 8-3.

##### **8-4.6.2 Imaginary Surfaces.**

Surfaces in space established around a STOVL facility in relation to the simulated LHD deck, and designed to define the protected airspace around the facility. The imaginary surfaces for the LHD STOVL facilities are the primary surface, transitional surface, inner horizontal surface, conical surface, outer surface and approach-departure path surfaces. These surfaces provide obstacle clearance for the F-35B day and night FCLP pattern. The day FCLP pattern altitude defines the inner horizontal surface and transitional area elevations. The night FCLP pattern defines the outer horizontal surface length and elevation, while the simulated IMC carrier controlled approach (CCA) profile defines the approach and departure path requirements. See Table 8-2. Note: the imaginary surfaces described in this chapter were developed only for F-35B operations. Airspace for other aircraft using the LHD facility must be evaluated separately.

##### **8-4.6.3 Accident Potential Zones.**

A land use control area beyond the clear zone of a STOVL facility that possesses a significant potential for accidents. Land use within the APZ is restricted in accordance with DoDI 4165.57. The dimensions and layout are listed in Table 8-3. Navy planners will use OPNAVINST 11010.36C/MCO 11010.16 (or latest version) to determine specific AICUZ requirements. For the Air Force, land use guidelines within the clear zone (beyond the graded area) and APZ I and APZ II are provided in AFI 32-7063 and AFH 32-7084.

#### **8-4.7 LHD Pavement Marking.**

Apply markings to LHD pavements using airfield marking paint with reflective beads (except LHD tram line, aircraft elevator outlines and clear zone markings outside deck outline without beads), following the general scheme shown in Figures 8-14 and 8-15. See NAVFAC Simulated LHD Shipdeck Standard Drawings for specific layout and

detailed dimensions. For new construction or modifications, ensure current marking requirements are obtained from NAWCAD 4.8.2.3. Taxiways and aprons connected to the LHD Facility will be marked according to UFC 3-260-04.

#### **8-4.8 LHD Lighting.**

Install airfield lights on the LHD deck following the general scheme shown in Figures 8-16 through 8-19. See NAVFAC Simulated LHD Shipdeck Standard Drawings for specific layout and detailed dimensions. For new construction or modifications, ensure current lighting requirements are obtained from NAWCAD 4.8.2.3. Shipboard lighting equipment will be certified annually by NAWCAD 4.8.7.5.

Special features of the lighting system include:

- Crows foot lighting for each landing spot should be on its own circuit so that the landing spot lights can be controlled individually.
- Airfield Lighting Power Supply may be from an airfield lighting vault adjacent to the LSO Tower within the island outline, or lighting systems may be powered from a nearby airfield lighting vault.
- LHD airfield lighting circuits do not require backup power.
- The following airfield lighting components should be placed on separate circuits:
  - Tramline Lights
  - STO Rotation Light (Pencil Line Light)
  - Landing Spot Lights
  - Landing Area Edge Light
  - Athwartship Lights
  - Nozzle Rotation Light
- Lighting systems and controls must be compatible with Night Vision Devices/Systems by stepped regulators or dimming.
- Taxiways and aprons connected to the LHD will be lit according to UFC 3-535-01.

#### **8-4.8.1 LSO Tower on LHD STOVL Facility.**

An LSO Tower will be included in all LHD STOVL facilities to provide lighting and control capabilities. Figure 8-20 shows key components and dimensions for the LSO Tower. See NAVFAC Simulated LHD Shipdeck Standard Drawings for specific layout and detailed dimensions. Other design considerations are listed in the following paragraphs.

##### **8-4.8.1.1 LSO Tower Structural Features.**

The tower structure will be designed to support all components (tower cab, lighting systems, stairs, catwalk, etc.) and withstand live loads (wind, seismic, etc.) per local design requirements. Jet exhaust and/or propeller wash from using aircraft will also be considered. Tower structure may be open metal framework or solid wall concrete or masonry, depending on local design requirements or preferences. Tower shall be designed to minimize movement (vibration) of OLS and HPI systems due to wind, jet blast or propeller wash.

#### **8-4.8.1.2 LSO Tower Cab Features.**

The LSO Tower Cab is designed to match the dimensions and layout of a LHD 5 cab, with the same controls and components found on a ship. The cab will include windows providing a clear view in all directions and angled out to allow observation directly down to the deck. Windows will include tinted screens to reduce sun glare within the cab. A backlit deck lighting control panel will be installed, with control systems to match the same shipboard components. Inside lighting shall be compatible with Night Vision devices/systems. See UFGS 08 88 58, *Air Traffic Control Tower Glass*, for additional guidance on tower cab windows.

#### **8-4.8.1.3 LSO Tower Lighting Features.**

Several lighting systems are mounted directly on the LSO Tower Cab. The navigational lighting systems must match the shipboard systems type and location and must be mounted in the same locations relative to the landing spots as found on an LHD 5 ship. Non-navigational lighting systems (floodlights, obstruction lights) shall be placed as needed for function. Lighting systems on the LSO Tower include:

- Visual Landing Aid (VLA) Systems
- Optical Landing System (OLS)
- Hover Point Indicator (HPI)
- Wave-off and Cut Lights
- Obstruction Lights
- Overhead Floodlights (Forward, Amidships, Aft)

#### **8-4.8.1.4 LSO Tower Communications Systems.**

The LSO Tower will include the following systems for communications with the base:

- Network data cable (for computer connection)
- Airfield Radio (minimum two frequencies) for communications with Air Traffic Control Tower, aircraft, and ground support.
- Telephone

#### **8-4.8.1.5 LSO Tower HVAC Systems.**

The LSO Tower Cab will be an air-conditioned space, designed to provide a comfortable temperature and humidity for occupants according to local design requirements, and considering heat loads from electronic components within the cab.

Design indoor space to the same conditions as described in UFC 4-133-01, Para 3-4.1. The airfield lighting vault building associated with the LHD facility shall be designed to keep the vault interior within the acceptable operating conditions for the contained power and control equipment.

**8-4.8.1.6 LSO Tower Weather Systems.**

Basic weather measurement systems (at a minimum, temperature, wind speed and direction) will be installed on or near the LSO Tower with data displayed inside the LSO Tower Cab.

**8-4.9 LHD Pavement Surface Types.**

Figures 8-21 and 8-22 show the pavement types needed for LHD Facilities. Pavements in Landing Spots 7 and 9 as well as the short takeoff lane must be constructed with CRHTC. PJHTC must be used in the areas indicated to support landings and/or hover operations where pavements will be exposed to high exhaust temperatures and high pressures. Shoulder and Safety Zone pavements may be constructed with PJPCC or HMA, but life cycle cost analysis should be used to evaluate the best choice. The paved safety zone pavement thickness will be designed in accordance with UFC 3-260-02, as Traffic Area B, for 2,500 passes of an F-35B aircraft loaded at 61,500 pounds. Paved surfaces under and surrounding Landing Spots have been expanded beyond the deck edge to support landing, hover, and takeoff operations by MV-22 and rotary-wing aircraft. Paved shoulders surrounding these landing spots must also be provided, as indicated. Adjust pavement type dimensions as needed to provide minimum 0.75 m (2.5 ft) between center of in-pavement lights and nearest rigid pavement joint. Use neoprene joint sealant for jointed PJHTC pavements within parking positions. Use silicone sealant for PJHTC pavements outside the LHD deck surface.

**Table 8-1. LHD STOVL Facility Deck Criteria**

Table 8-1. LHD STOVL Facility Deck Criteria			
Item		Requirement	Remarks
No.	Description		
1	Simulated Deck Length	257.3 m (844 ft)	Simulated LHD Deck
2	Simulated Deck Width	36.6 m (120 ft)	Simulated LHD Deck
3	Left Paved Shoulder	Length: 257.3 m (844 ft)  Width: 45.7 m (150 ft)	Left shoulder serves as a safety zone abeam the simulated L-class deck for approach and wave-off to prevent erosion of graded surfaces by jet blast from aircraft transition to and from the STOVL facility. See Paragraph 8-4.9 for pavement type in shoulder areas. Exceeds Air Force, Navy and Marine Corps airfields criteria.

Table 8-1. LHD STOVL Facility Deck Criteria			
Item		Requirement	Remarks
No.	Description		
4	Right Paved Shoulder	Length: 257.3 m (844 ft)  Width: 7.6 m (25 ft)	Right shoulder serves as a safety zone abeam the simulated L-class deck to prevent erosion of graded surfaces by jet blast from aircraft transition to and from the STOVL facility. Consideration should be given to expanding the shoulder width directly abeam the primary landing spots to provide added protection against erosion. See Note 1. Meets Air Force criteria and exceeds Navy and Marine Corps airfields criteria.
5	Forward Safety Zone	Length: 152.4 m (500 ft)  Width: 51.8 m (170 ft)	Forward safety zone serves as an overrun off the bow of the simulated L-class deck. Safety zones are provided to prevent erosion of graded surfaces by jet blast from aircraft departing from the STOVL facility. See Note 1.
6	Approach Safety Zone	Length: Min 457.2 m (1,500 ft)  Width: Min 82.3 m (270 ft)	Approach safety zone is provided to prevent erosion of graded surfaces by jet blast from aircraft landing at the STOVL facility. See Note 1. The length of the approach safety zone will be dependent on the length of the STOVL facility plus any approach path length where the aircraft will be below 150 ft AGL. (For example: 1500 ft approach @ 3 deg. = 80 ft, plus 70 ft hover abeam spot = 150 ft AGL).
7	Longitudinal grades of runway and shoulders	0% min 0.87% max	Grades may be both positive and negative but must not exceed the limit specified. Maximum composite grade is 1.5%. Grade restrictions are exclusive of other pavements and shoulders. Where other pavements tie into runways, comply with grading requirements for towways, taxiways, or aprons as applicable, but hold grade changes to the minimum practicable to facilitate drainage.
8	Longitudinal runway grade change	No grade change is to occur	Where economically feasible, the runway will have a constant centerline gradient from end to end.  <u>Exception:</u> Where HTC is built 2" higher than the surrounding pavement, transition down to the surrounding pavement elevation over a 15-ft length. As future HTC surface grinding occurs, the slope of the transition pavement will decrease.

Table 8-1. LHD STOVL Facility Deck Criteria			
Item		Requirement	Remarks
No.	Description		
9	Longitudinal safety zone grade	0% min 3% max	<p>Grades may be both positive and negative but must not exceed the limit specified. Grade restrictions are exclusive of other pavements and shoulders.</p> <p>Where other pavements tie into runways, comply with grading requirements for towways, taxiways, or aprons as applicable, but hold grade changes to the minimum practicable to facilitate drainage.</p> <p>Slope pavement downwards from the foul line for simulated ship decks, which runs roughly down the center of the deck, or centerline for runways.</p> <p>The selected transverse grade is to remain constant for the length and width of the simulated L-class ship deck, except at or adjacent to intersections where the pavement surfaces must be warped to match abutting pavements.</p>
10	Transverse grade of runway	Min 0.5% Max 0.87%	<p>New STOVL training facility pavements will be foul line crowned or sloped decks. Maximum composite grade is 1.5%.</p> <p>A uniform slope is preferable to eliminate irregularities between landing gear during touchdown. The simulated deck surface will be foul line crowned with uniform slope in opposing directions to the edges of the simulated deck, or the entire deck slope to insure surface water drainage and runoff.</p> <p>Existing STOVL facility and runway pavements with insufficient transverse gradients for rapid drainage should provide increasing gradients when overlaid or reconstructed.</p> <p><u>Exception:</u> Where HTC is built 2" higher than the surrounding pavement, transition down to the surrounding pavement elevation over a 15-ft length. As future HTC surface grinding occurs, the slope of the transition pavement will decrease.</p>
11	Transverse grade of paved shoulder	0.5% min 3% max	Paved portion of shoulder should slope downward from deck pavement. Reversals are not allowed. Ideally, 2% Min. for first 25 ft, then 0.5% Min. farther away from runway.
12	Transverse grade of safety zone	0.5% min 3% max	Slope pavement downwards from the simulated ship deck with no reversals to insure adequate drainage and surface water runoff. Exception is at or adjacent to intersections where the pavement surfaces must be warped to match abutting pavements.



Table 8-1. LHD STOVL Facility Deck Criteria			
Item		Requirement	Remarks
No.	Description		
13	Runway Lateral Clearance Zone (corresponds to half the width of primary surface)	Width: 45.72 m (150 ft)	<p>Supports VFR operations.</p> <p>Width measured perpendicularly from the port deck edge of the simulated LHD surface.</p> <p>This area is to be clear of fixed and mobile obstacles. In addition to the lateral clearance criterion, the vertical height restriction on structures and parked aircraft as a result of the transitional slope must be taken into account. Fixed obstacles include man-made or natural features constituting possible hazards to moving aircraft.</p> <p><u>Exception or Permissible Deviation (Air Force):</u> LSO tower.</p>
14	Longitudinal grades within Runway Lateral Clearance Zone	Max 10.0%	<p>Does not apply to paved shoulders, safety zones, and cover over drainage structures.</p> <p>Slopes are to be as gradual as practicable. Avoid abrupt changes or sudden reversals. Rough grade to the extent necessary to minimize damage to aircraft.</p>
15	Distance from Centerline of Fixed-Wing Runway to the Centerline of a parallel STOVL runway	Min 304.80 m (1,000 ft)	Simultaneous VFR operations for Class B runway for Air Force, Navy and Marine Corps.
		Min 213.36m (700 ft)	Non-simultaneous VFR and IFR operations. Distance may be reduced to 60.96m (200ft); however, waiver must be based on wake-turbulence and jet blast.
			NOTE: LSO Tower and other aboveground structure siting must be based on runway obstacle evaluation and must not be an obstruction to the adjacent runway(s) imaginary surfaces.
16	Width of Graded Area Each Side of LHD	45.72 m (150 ft)	Extends outward each side of Left and Right Paved Shoulders.
17	Length of Graded Area Each End of LHD	304.80 m (1,000 ft)	Extends outward from the Forward and Approach Safety Zones.
18	Longitudinal or Transverse Grade in Graded Area	Max. 10.0%	Preferred slope downward, but may include upward slopes provided graded elevation does not exceed Primary Surface elevation.

**Table 8-2. LHD STOVL Facility Airspace Imaginary Surfaces**

Table 8-2. LHD STOVL Facility Airspace Imaginary Surface				
Item		Legend	Requirement	Remarks
No.	Description			
1	Primary surface width	A	91.44 m (300 ft)	Centered on port deck edge of the Simulated LHD Deck. At US Navy and Marine Corps VTSOL facilities where the lateral clearance was established according to previous criterion, that distance may remain.
2	Primary surface length	A	Deck length + 60.96 m (200 ft) at departure end	Primary surface extends 60.96 m (200 ft) beyond the departure end of the simulated LHD Deck. The primary surface ends at the approach end or fantail of the simulated deck.
3	Primary surface elevation	A		The elevation of any point on the primary surface is the same as the elevation of the nearest point on the deck centerline
4	Clear zone surface (graded area)	B	Length: 304.8 m (1,000 ft)  Width: 91.44 m (300 ft)	See LHD STOVL Deck Facility Criteria, Table 8-1, Item 14
5	Start of approach-departure surface	C	Approach: 0 m (0 ft) Departure: 60.96 m (200 ft)	Measured from the corresponding deck edge of the simulated LHD deck. The facility is not bi-directional so the requirements for the approach and departure surfaces reflect planned aircraft profile.
6	Length of sloped portion of approach-departure surface	C	5,334.0 m (17,500 ft)	Measured horizontally. This distance reflects the horizontal distance that corresponds with an increase in elevation to meet the outer surface elevation.
7	Slope of approach-departure surface	C	35:1	Slope ratio is horizontal: vertical.  Example: 35:1 is 35 m (ft) horizontal to 1 m (ft) vertical.
8	Width of approach-departure surface at start of sloped portion	C	91.44 m (300 ft)	Centered on the port deck edge of the simulated LHD surface and this width represent the same rate of change in width as a Class-A VFR runway. - At US Navy and Marine Corps STOVL facilities where the lateral clearance was established according to previous criterion, that distance may remain.

Table 8-2. LHD STOVL Facility Airspace Imaginary Surface				
Item		Legend	Requirement	Remarks
No.	Description			
9	Width of approach-departure surface at end of sloped portion	C	891.50 m (2,925 ft)	Centered on the port deck edge of the simulated LHD surface and this width represent the same rate of change in width as a Class-A VFR runway. - The 1000:75 width ratio is horizontal length: horizontal width. This ratio is consistent with Class-A VFR runway requirements. - At US Navy and Marine Corps STOVL facilities where the lateral clearance was established according to previous criterion, that distance may remain.
10	Elevation of approach-departure surface at start of sloped portion	C	0 m (0 ft)	Same as the simulated ship deck centerline at the threshold
11	Elevation of approach-departure surface at end of sloped portion	C	152.4 m (500 ft)	Above the established simulated ship deck elevation
12	Start of horizontal portion of approach-departure surface	D	NA	Approach-departure horizontal surface not required
13	Length of horizontal portion of approach-departure surface	D	NA	Approach-departure horizontal surface not required
14	Width of approach-departure surface at start of horizontal portion	D	NA	Approach-departure horizontal surface not required

Table 8-2. LHD STOVL Facility Airspace Imaginary Surface				
Item		Legend	Requirement	Remarks
No.	Description			
15	Width of approach-departure surface at end of horizontal portion	D	NA	Approach-departure horizontal surface not required
16	Elevation of horizontal portion of approach-departure surface	D	NA	Approach-departure horizontal surface not required
17	Radius of inner horizontal surface	E	1,600 m (5,250 ft)	An imaginary surface constructed by scribing an arc with a radius of 1600 m (5250 ft) about the centerline at each end of the simulated ship deck and interconnecting these arcs with tangents. This radius (distance) corresponds to the increase in elevation for the sloped approach-departure surfaces.
18	Width between outer edges of inner horizontal surface	E	3,200 m (10,500 ft)	
19	Elevation of inner horizontal surface	E	45.72 m (150 ft)	Above the established simulated ship deck elevation. Exception: When the LHD is adjacent to an airfield, the inner horizontal surface is established to match the adjacent airfield's inner horizontal surface.
20	Horizontal width of conical surface	F	2,133.6 m (7,000 ft)	Extends horizontally outward from the outer boundary of the inner horizontal surface.
21	Slope of conical surface	F	20:1	Slope ratio is horizontal: vertical.  Example: 20:1 is 20 m (ft) horizontal to 1 m (ft) vertical.
22	Elevation of conical surface at the start of slope	F	45.72 m (150 ft)	Above the established simulated ship deck elevation.

Table 8-2. LHD STOVL Facility Airspace Imaginary Surface				
Item		Legend	Requirement	Remarks
No.	Description			
23	Elevation of conical surface at the end of slope	F	152.4 m (500 ft)	Above the established simulated ship deck elevation.
24	Distance to outer edge of conical surface	G	3,733.6 m (12,250 ft)	
25	Width of outer horizontal surface	G	9144 m (30,000 ft)	Extending horizontally outward from the outer periphery of the conical surface.
26	Elevation of outer horizontal surface	G	152.4 m (500 ft)	Above the established simulated ship deck elevation.
27	Distance to outer edge of outer horizontal surface	G	12,877.0 m (42,250 ft)	An imaginary surface constructed by scribing an arc with a radius of 12,877.0 m (42,250 ft) about the centerline at each end of the simulated ship deck and interconnecting these arcs with tangents.
28	Start of transitional surface	H	45.72 m (150 ft)	Measured perpendicularly from the port deck edge of the simulated LHD surface.
29	End of transitional surface	H	Various	The transitional surface ends at the inner horizontal surface, conical surface, or at an elevation of 45.72 m (150 ft).  See NOTE 1
30	Slope of transitional surfaces	H	2:1	Slope ratio is horizontal: vertical.  2:1 is 2 m (ft) horizontal to 1 m (ft) vertical. Vertical height of vegetation and other fixed or mobile obstacles and/or structures will not penetrate the transitional surface.  Taxiing aircraft are exempt from this requirement. For Navy and Marine Corps airfields, taxiway pavements are exempt from this requirement. For the USAF, the air traffic control tower is exempt from this requirement if the height will not affect TERPS criteria.

**NOTES:**

1. When the LHD STOVL facility is located within the boundaries of an existing DoD airfield and the imaginary surfaces of the two facilities overlap, the LHD transitional surface elevation will extend to meet the existing inner horizontal surface elevation of the DoD airfield. The LHD imaginary surface requirements may be waived provided the existing

DoD airfield imaginary surfaces meet or exceed the obstacle clearance requirements defined by the imaginary surfaces in Table 8-2.

- When the LHD STOVL facility is located parallel with an existing DoD runway use of the runway approach/departure surface may suffice for the LHD approach/departure surface provided a visual transition between the path and the LHD STOVL facility can be conducted while under VMC conditions.

**Table 8-3. LHD STOVL Facility Clear Zone and APZs**

Table 8-3. LHD STOVL Facility Clear Zone and Accident Potential Zone (APZ)				
Item		Legend	Requirement	Remarks
No.	Description			
1	Clear Zone	B	Departure Clear Zone  Length: 304.80m (1,000 ft)  Width: 91.44m (300 ft)	Length measured along the extended tram line beginning at the end of the primary surface.  Width measured perpendicular to the extended tram line and is centered on the port deck edge of the simulated LHD surface.
			Approach Clear Zone  Length: 914.40m (3,000 ft)  Width: 91.44m (300 ft)	Length measured along the extended tram line beginning at the end of the primary surface.  Width measured perpendicular to the extended tram line and is centered on the port deck edge of the simulated LHD surface.
2	APZ I	J	Departure  Length: 762.00m (2,500 ft)  Width: 152.40m (500 ft)	APZ I starts at the end of the clear zone, and is centered on the port deck edge of the simulated LHD surface.
			Approach  Length: 762.00m (2,500 ft)  Width: 228.60m (750 ft)	APZ I starts at the end of the clear zone, and is centered on the port deck edge of the simulated LHD surface.
3	APZ II	J	Length: 2,133.60m (2,500 ft)  Width: 304.80m (1,000 ft)	APZ II starts at the end of the APZ I and is centered on the port deck edge of the simulated LHD surface.

Figure 8-1. LHD STOVL Facility Outline

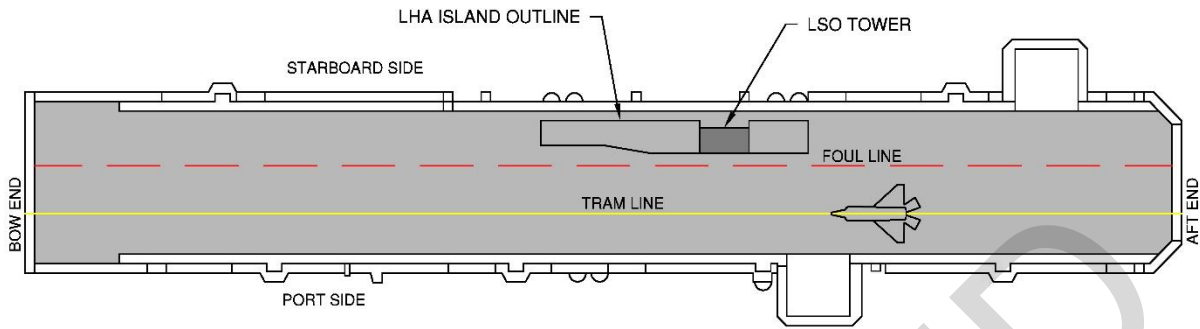

Figure 8-2. LHD STOVL Facility Safety Zones

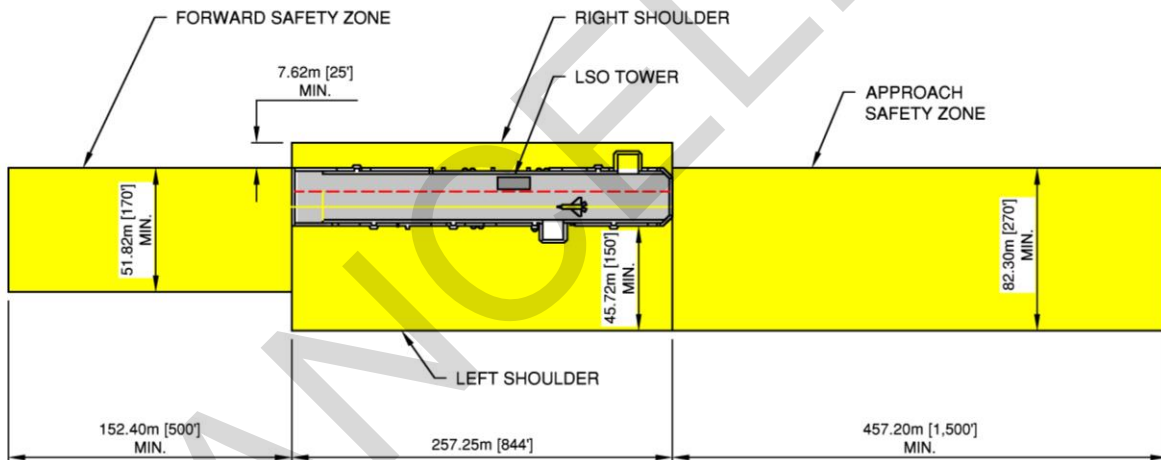
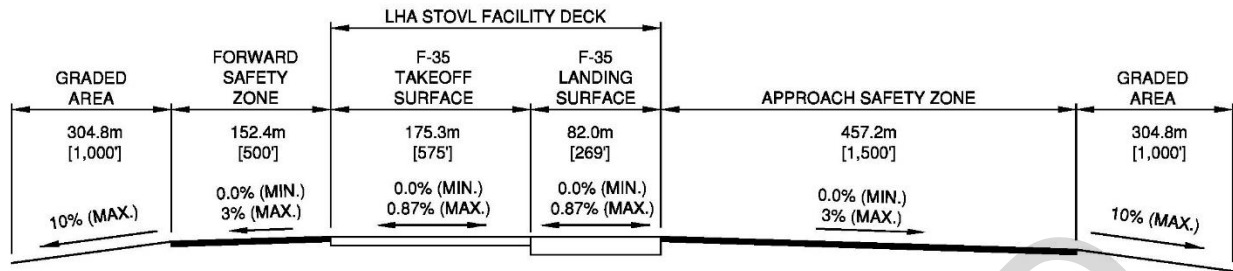
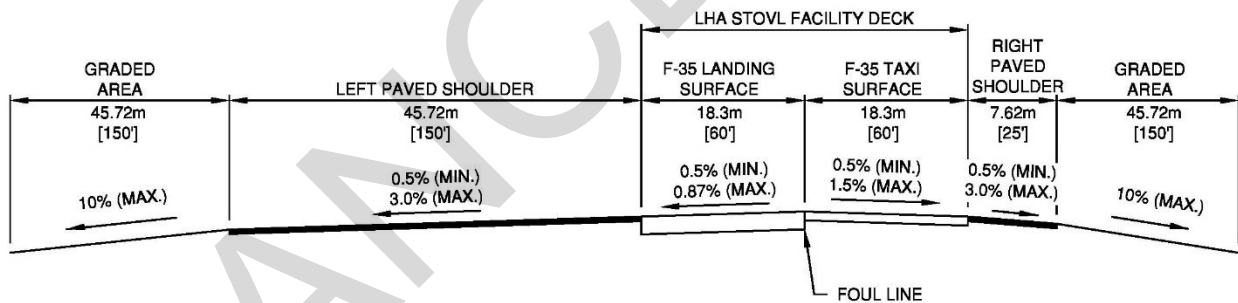

Figure 8-3. LHD STOVL Facility Longitudinal Gradient



LHA STOVL FACILITY LONGITUDINAL SECTION  
N.T.S.

Figure 8-4. LHD STOVL Facility Transverse Section



LHA STOVL FACILITY TRANSVERSE SECTION  
N.T.S.



Figure 8-5. LHD STOVL Facility Departure Clearance Surface and Clear Zone

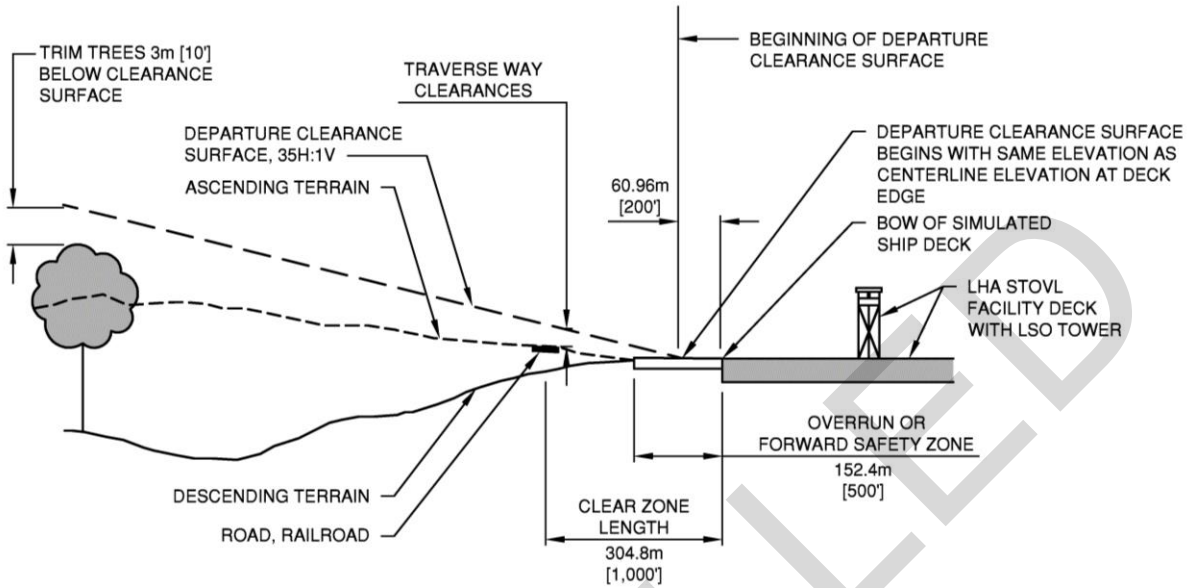

Figure 8-6. LHD STOVL Facility Departure Clear and Accident Potential Zones

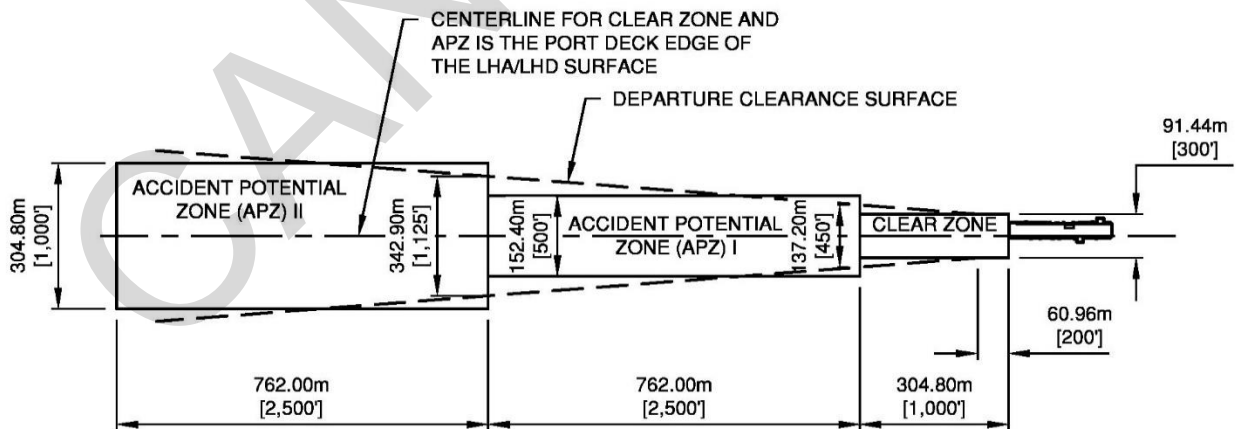
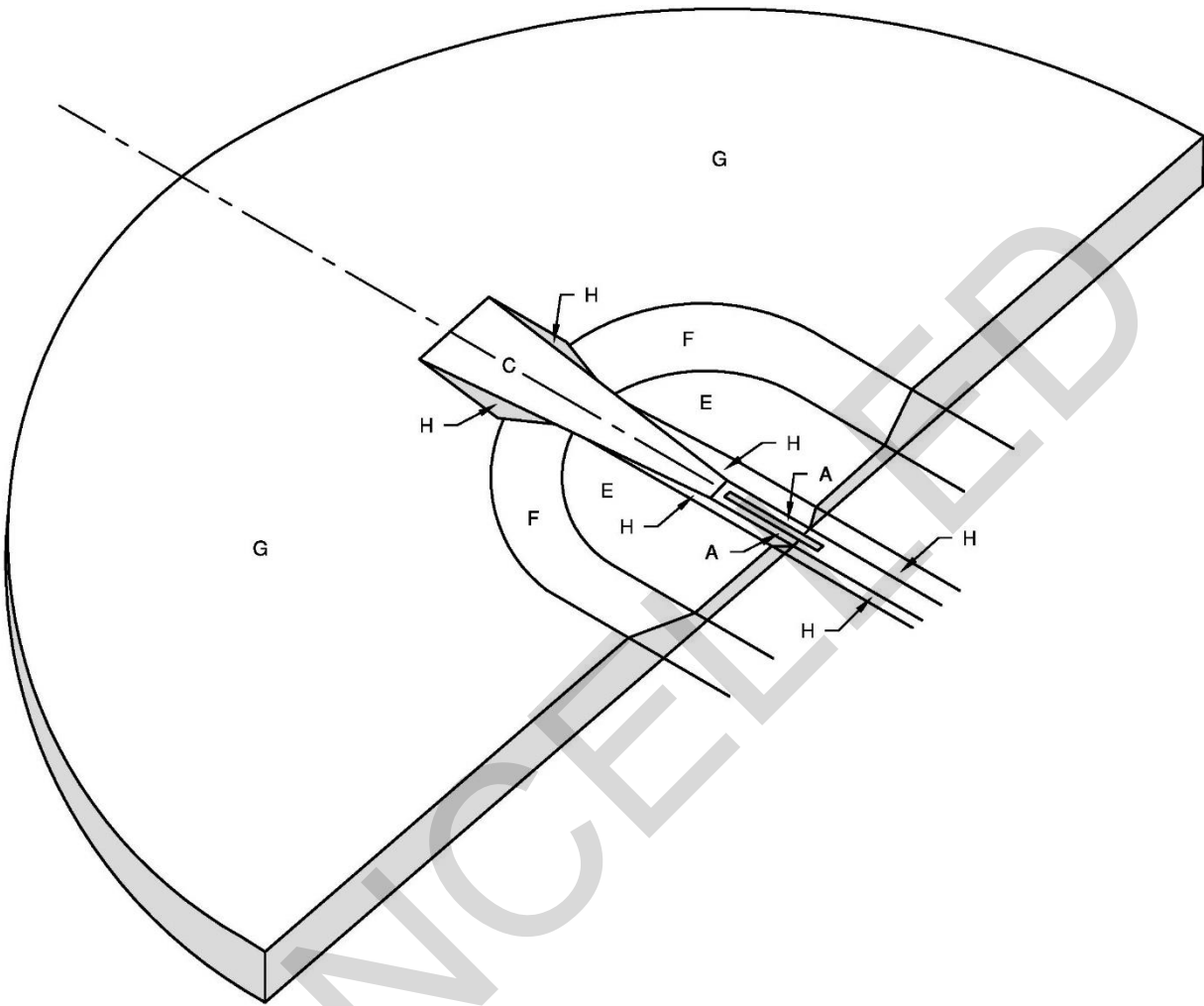

Figure 8-7. LHD STOVL Facility Departure Surface Isometric View



LEGEND

- A PRIMARY SURFACE
- B CLEAR ZONE SURFACE (NOT SHOWN)
- C DEPARTURE CLEARANCE SURFACE (35:1 SLOPE RATIO)
- D NOT USED
- E INNER HORIZONTAL SURFACE (45.72m [150'] ELEVATION)
- F CONICAL SURFACE (20:1 SLOPE RATIO)
- G OUTER HORIZONTAL SURFACE (152.40m [500'] ELEVATION)
- H TRANSITIONAL SURFACE (2:1 SLOPE RATIO)
- I NOT USED
- J ACCIDENT POTENTIAL ZONE (APZ) (NOT SHOWN)

ISOMETRIC

N.T.S.

Figure 8-8. LHD STOVL Facility Departure Surface and Transverse Imaginary Surfaces

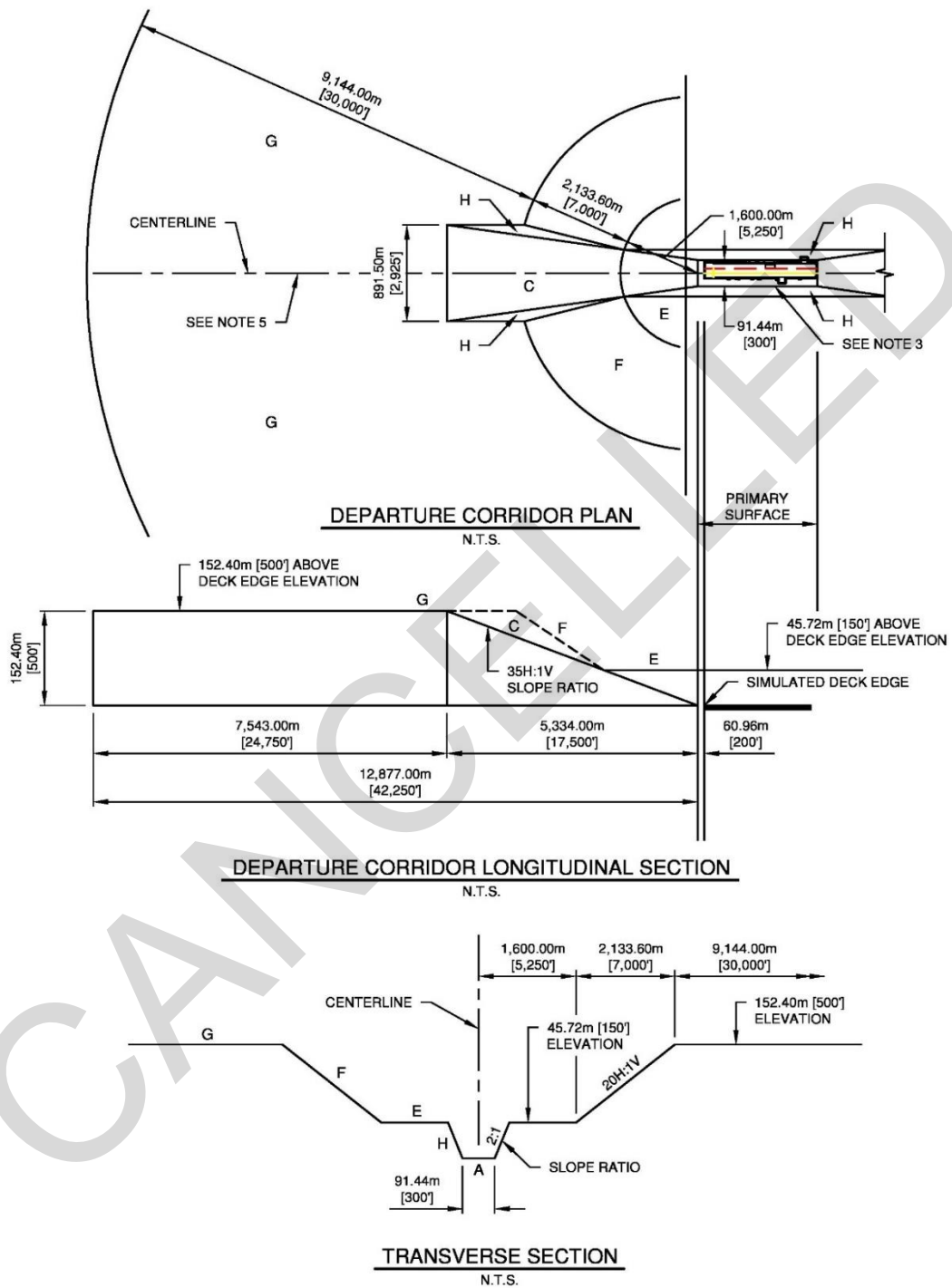

**NOTE**  
LEGEND AND NOTES IN NEXT FIGURE APPLY.

Figure 8-9. LHD STOVL Facility Approach Path Imaginary Surfaces

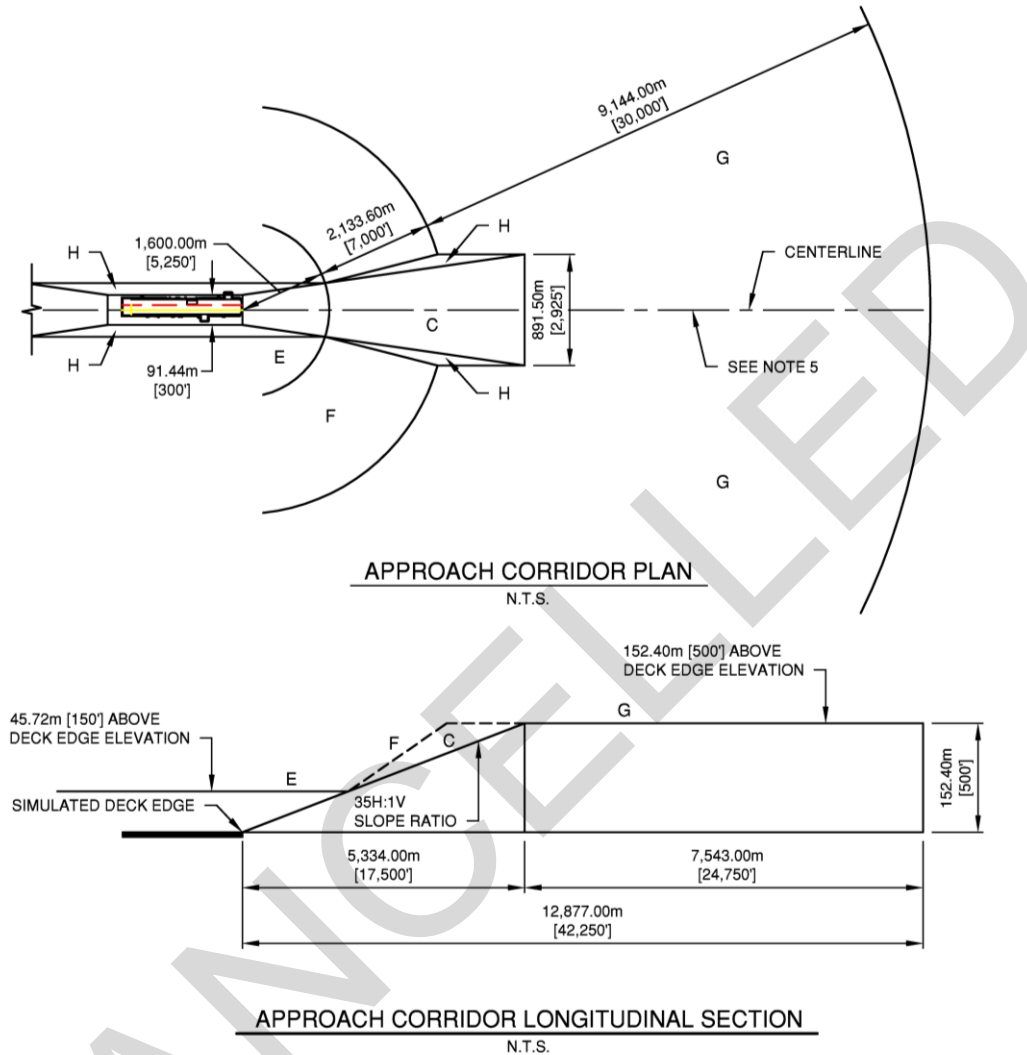

**NOTES**

1. DATUM ELEVATION FOR:
  - a. SURFACES E, F AND G IS THE ESTABLISHED AIRFIELD ELEVATION.
  - b. SURFACE C IS THE RUNWAY CENTERLINE ELEVATION AT THE THRESHOLD.
  - c. SURFACE H VARIES AT EACH POINT ALONG THE RUNWAY CENTERLINE.
2. THE SURFACES SHOWN ON THE PLAN ARE FOR A LEVEL RUNWAY.
3. 91.44m [300'] PRIMARY SURFACE WIDTH FOR SIMULATED LHA DECK.
4. APPROACH AND DEPARTURE CORRIDORS END WHEN SLOPE SURFACE REACHES 500' AGL.
5. CENTERLINE FOR THE IMAGINARY SURFACES IS THE LEFT (PORT) DECK EDGE OF THE LHA SURFACE.

**LEGEND**

- |   |  |
|---|--|
| A | PRIMARY SURFACE                                |
| B | CLEAR ZONE SURFACE - NOT SHOWN                 |
| C | APPROACH - DEPARTURE CLEARANCE SURFACE (SLOPE) |
| D | NOT USED                                       |
| E | INNER HORIZONTAL SURFACE                       |
| F | CONICAL SURFACE                                |
| G | OUTER HORIZONTAL SURFACE                       |
| H | TRANSITIONAL SURFACE                           |
| I | NOT USED                                       |
| J | ACCIDENT POTENTIAL ZONE (APZ) - NOT SHOWN      |

Figure 8-10. LHD STOVL Facility Approach Surface Isometric View

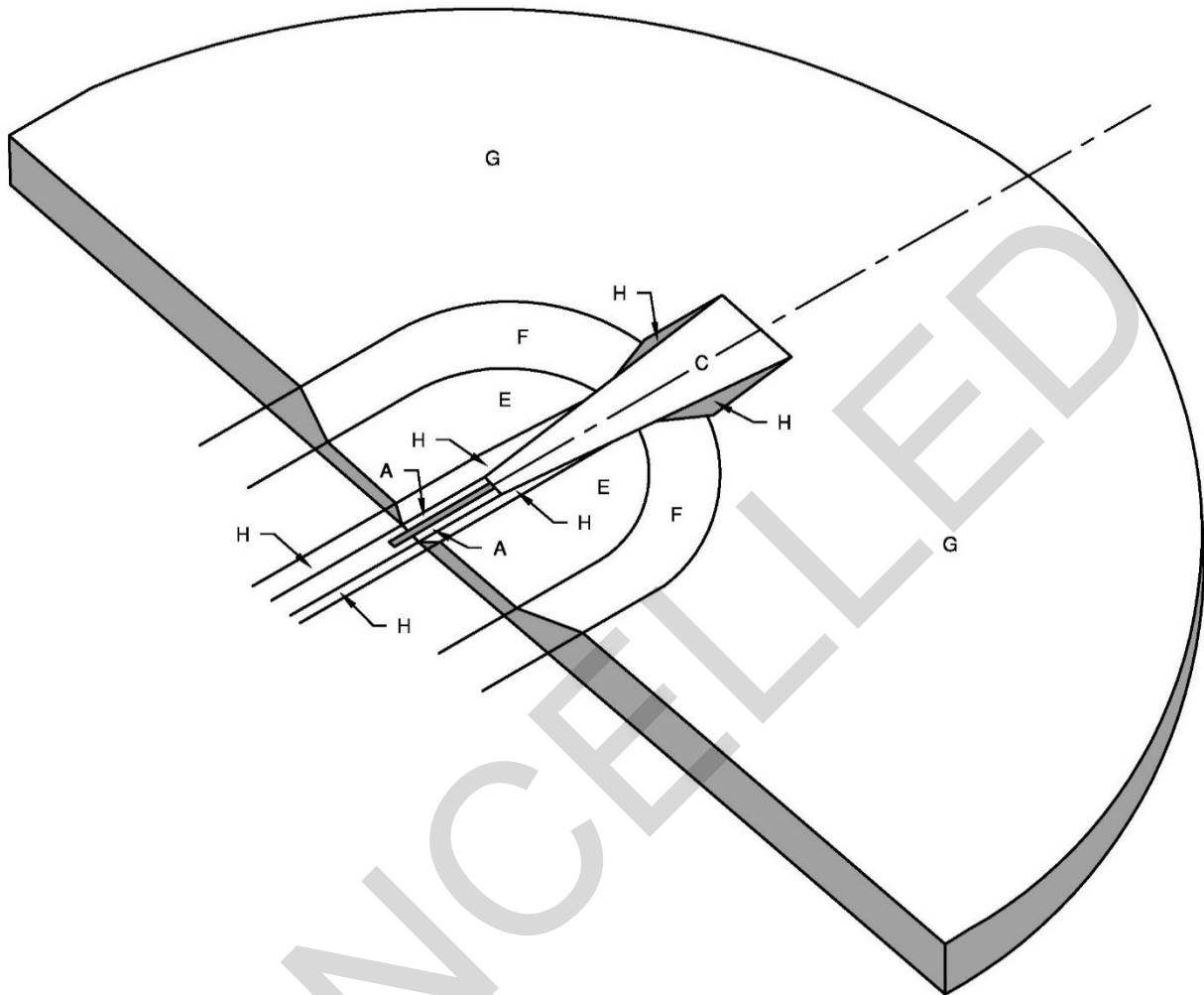

LEGEND

- |   |   |
|---|---|
| A | PRIMARY SURFACE                                     |
| B | CLEAR ZONE SURFACE (NOT SHOWN)                      |
| C | APPROACH CLEARANCE SURFACE (35:1 SLOPE RATIO)       |
| D | NOT USED  |
| E | INNER HORIZONTAL SURFACE (45.72m [150'] ELEVATION)  |
| F | CONICAL SURFACE (20:1 SLOPE RATIO)                  |
| G | OUTER HORIZONTAL SURFACE (152.40m [500'] ELEVATION) |
| H | TRANSITIONAL SURFACE (2:1 SLOPE RATIO)              |
| I | NOT USED  |
| J | ACCIDENT POTENTIAL ZONE (APZ) (NOT SHOWN)           |

ISOMETRIC  
N.T.S.

Figure 8-11. LHD STOVL Facility Approach Path Clear Zones and APZs

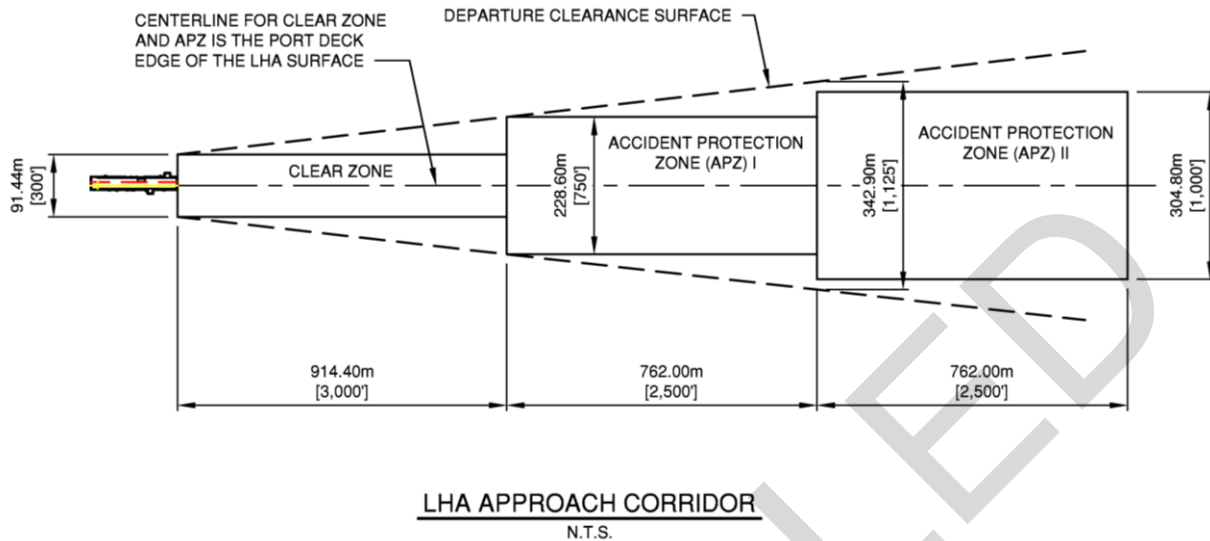

Figure 8-12. LHD STOVL Facility Approach Path Clear Zones

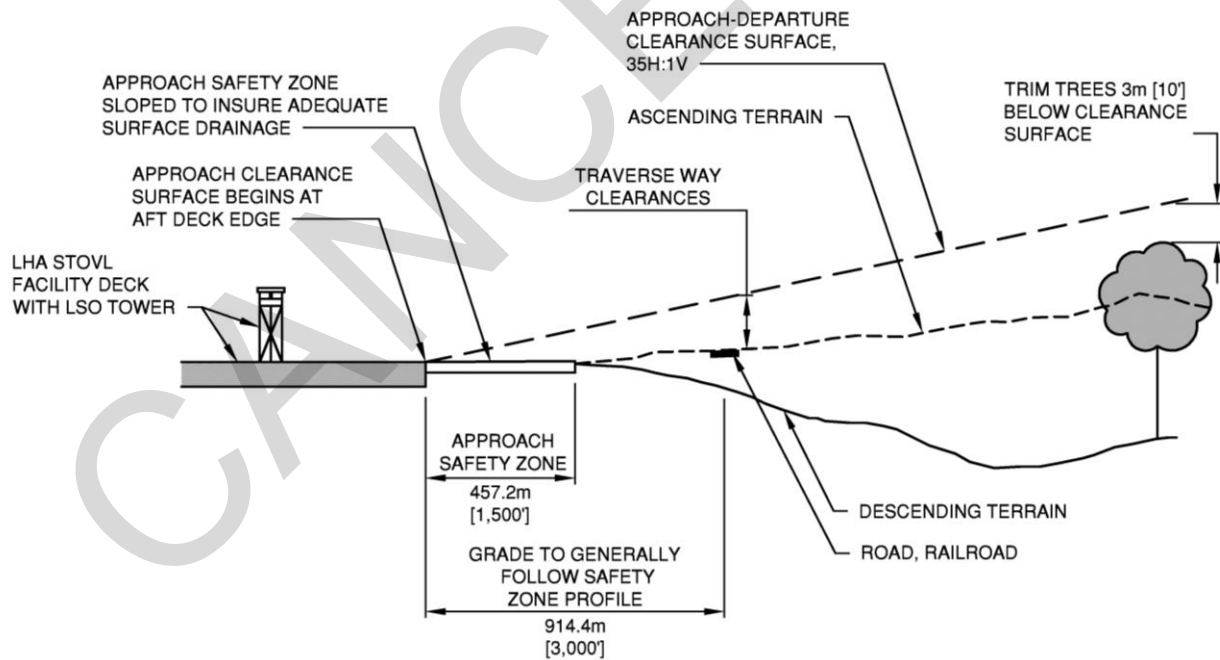
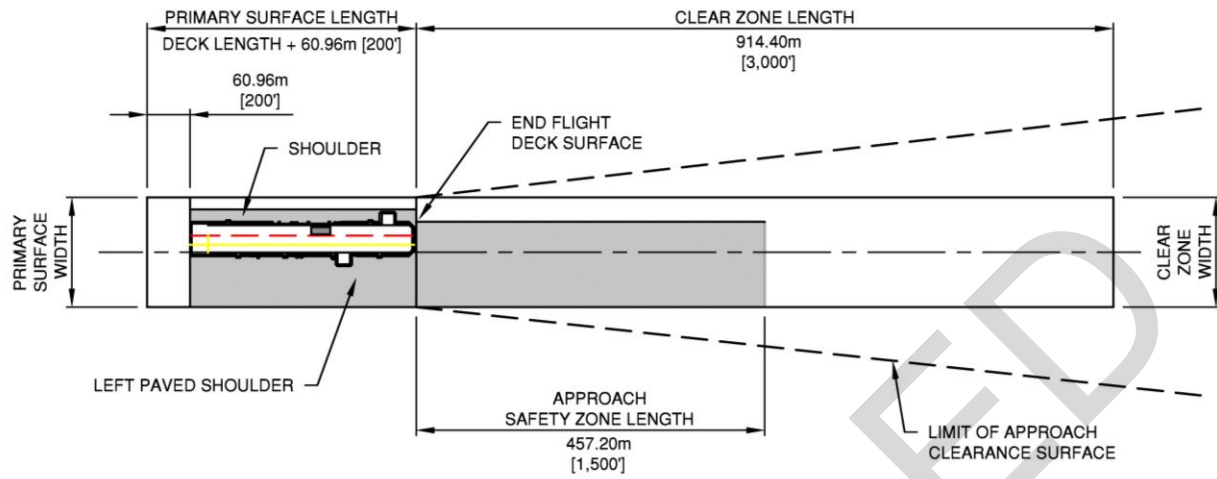

Figure 8-13. LHD STOVL Facility Approach End Details



CANCELLED

Figure 8-14. LHD Overall Marking

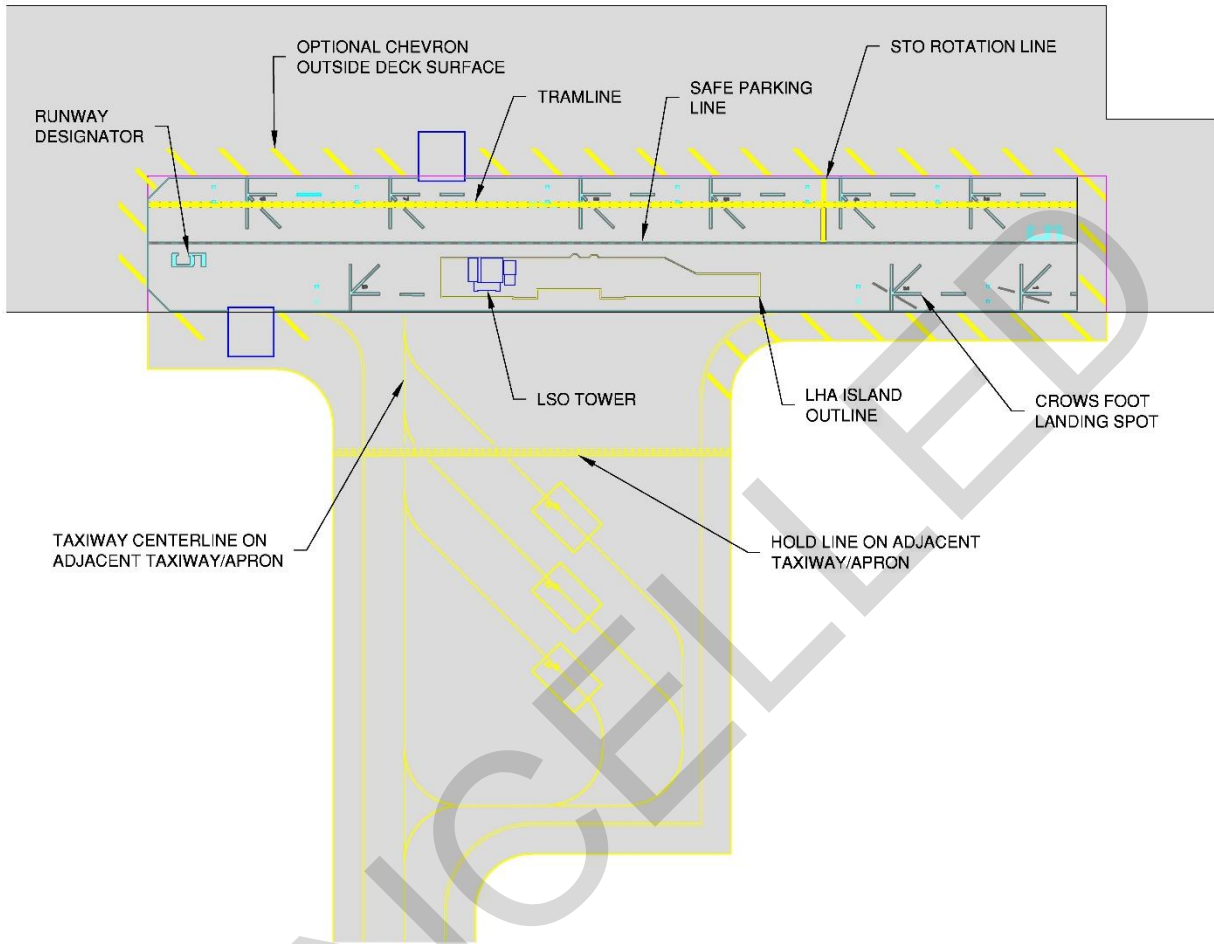



Figure 8-15. LHD Marking Details

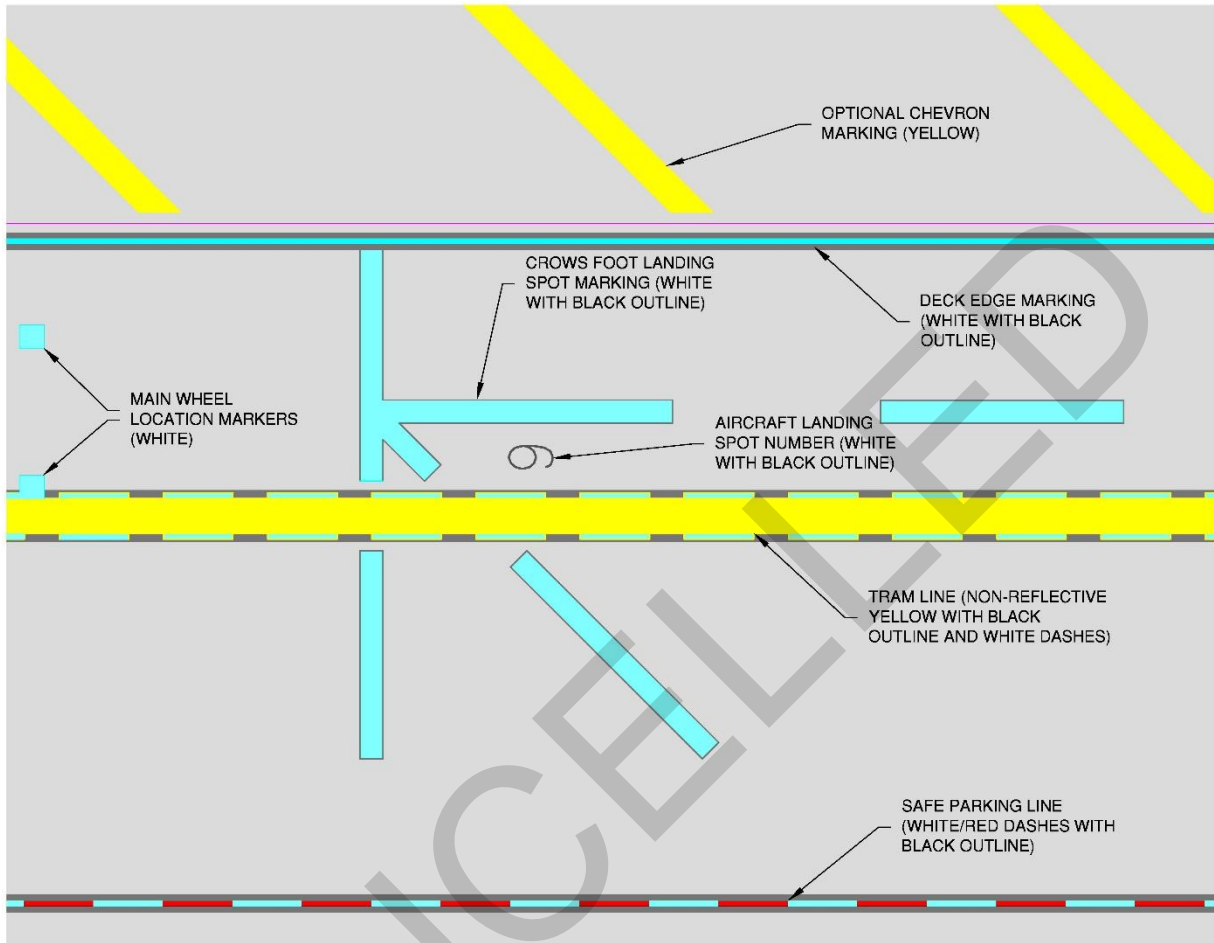

Figure 8-16. LHD Overall Lighting

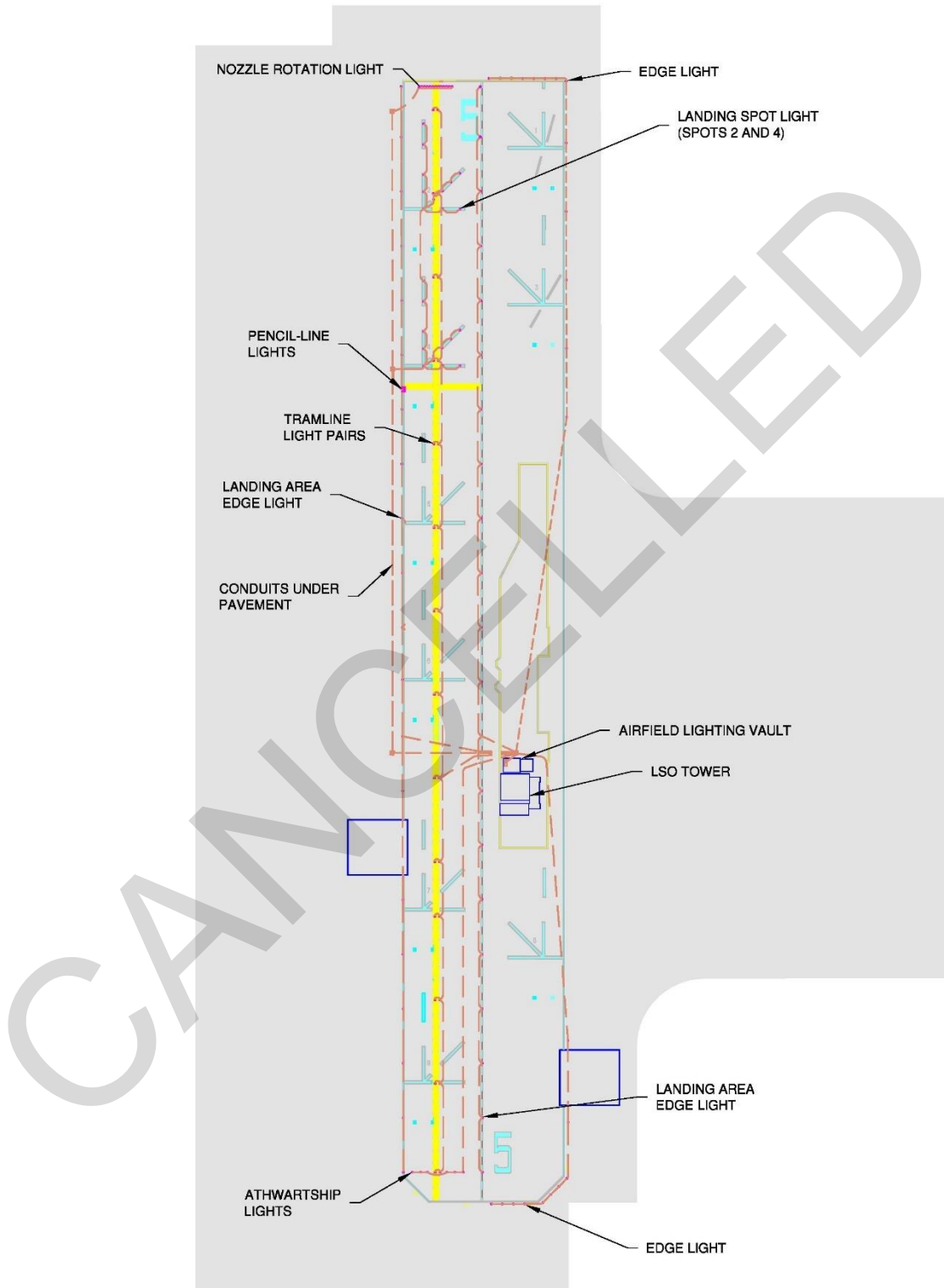

Figure 8-17. LHD Aft Deck Lighting

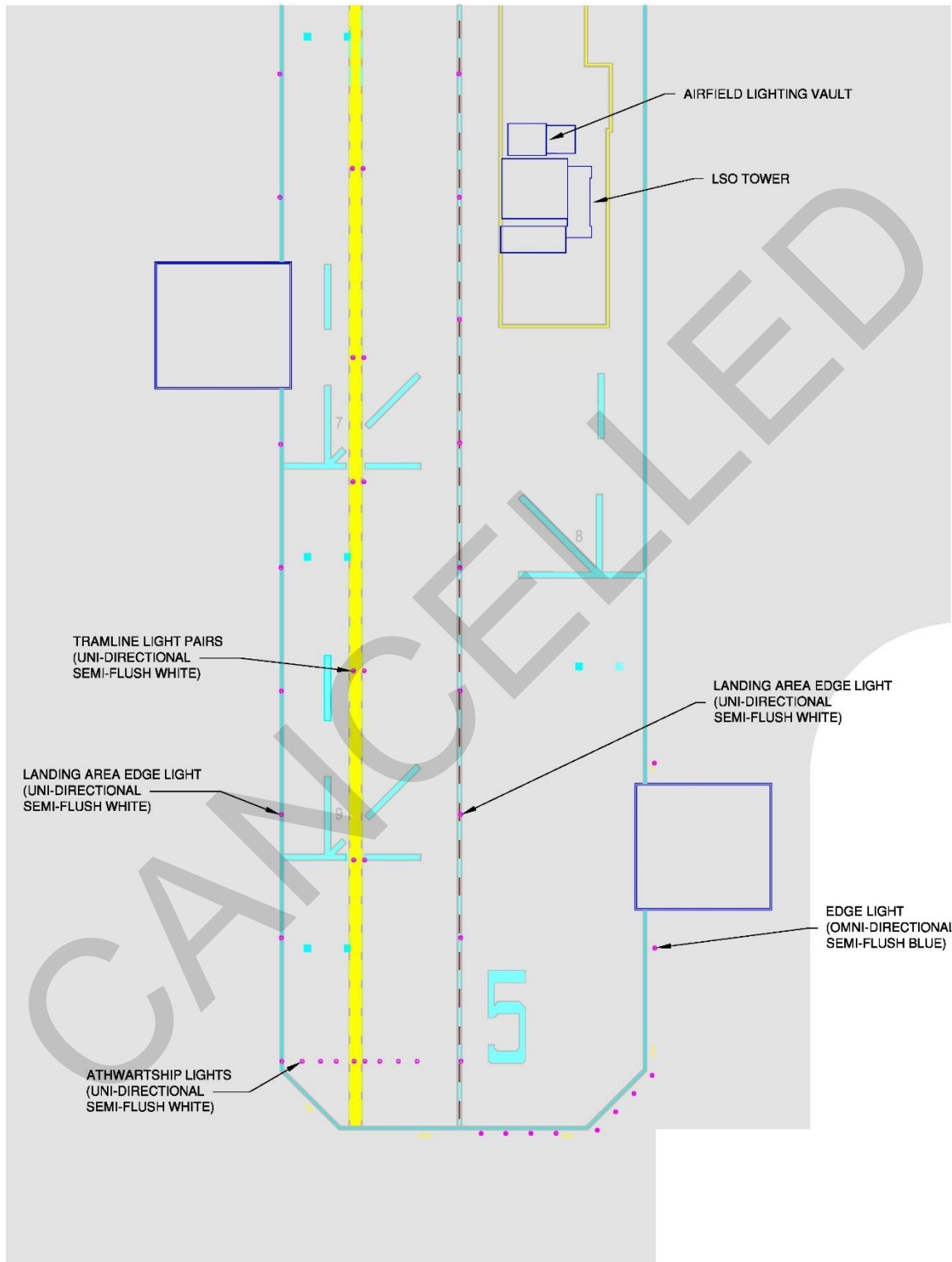

Figure 8-18. LHD Forward Deck Lighting

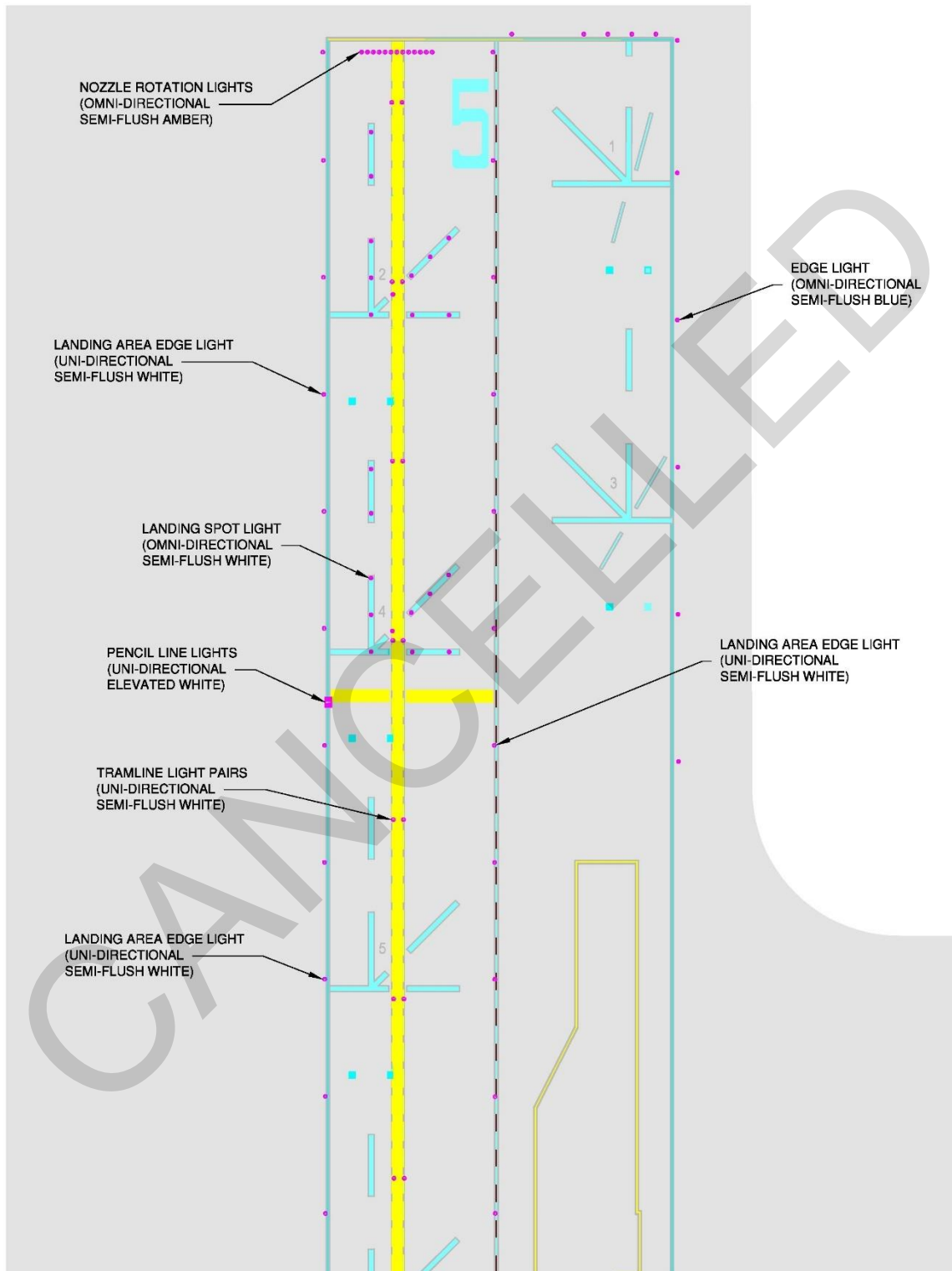

Figure 8-19. LHD Landing Spot Lighting Detail

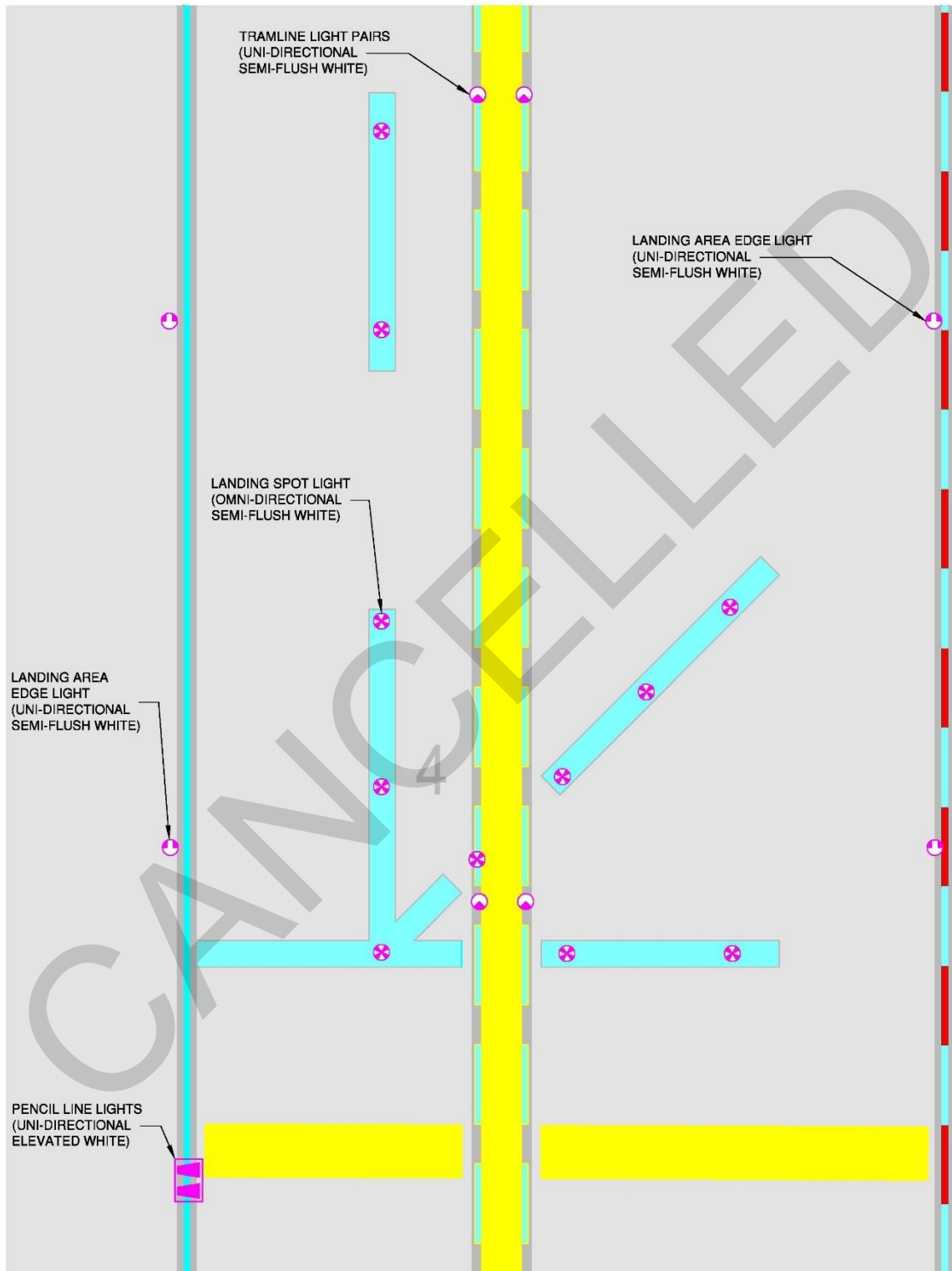

Figure 8-20. LHD LSO Tower Elevation Detail

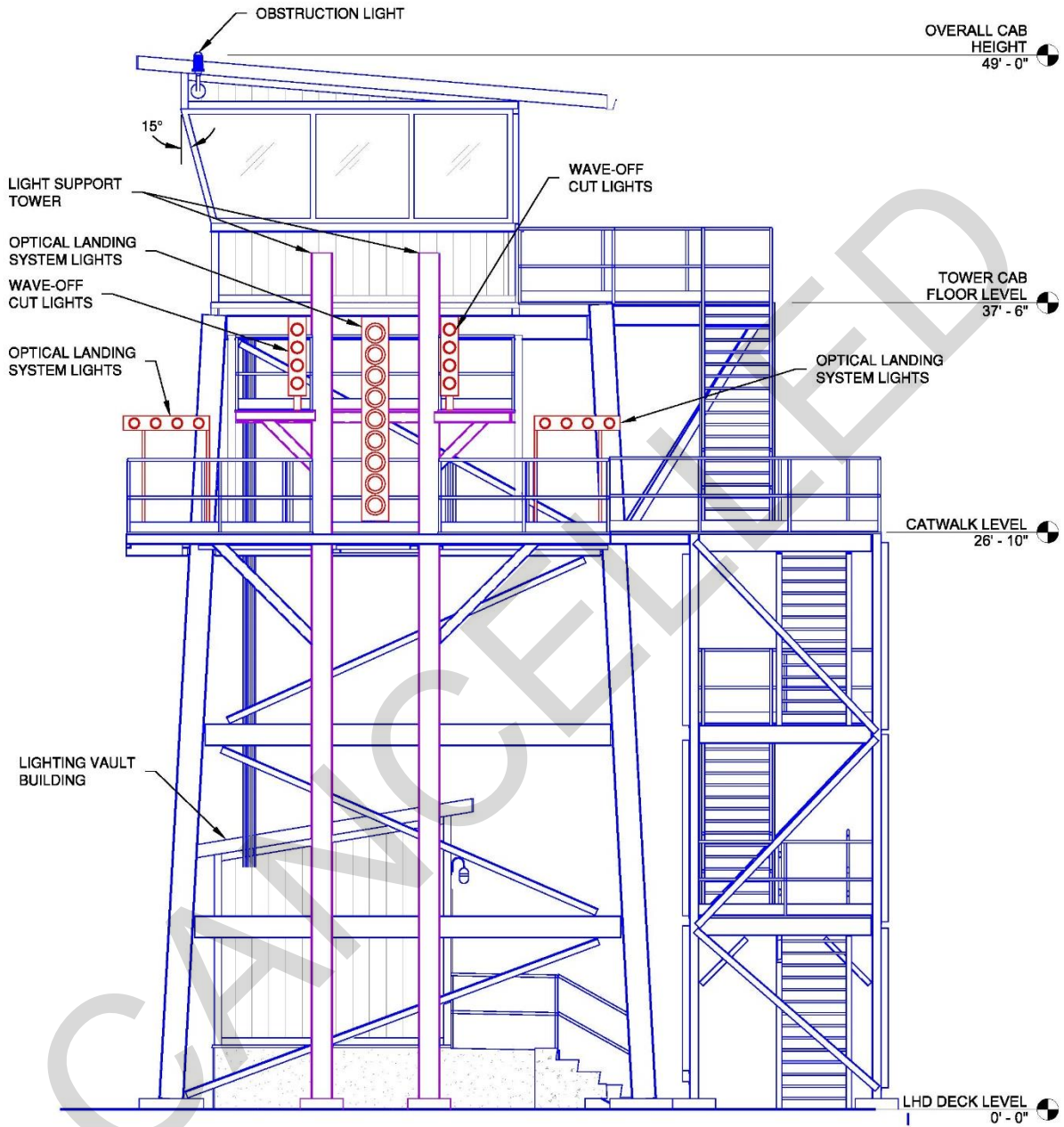

Figure 8-21. LHD Pavement Surface Types

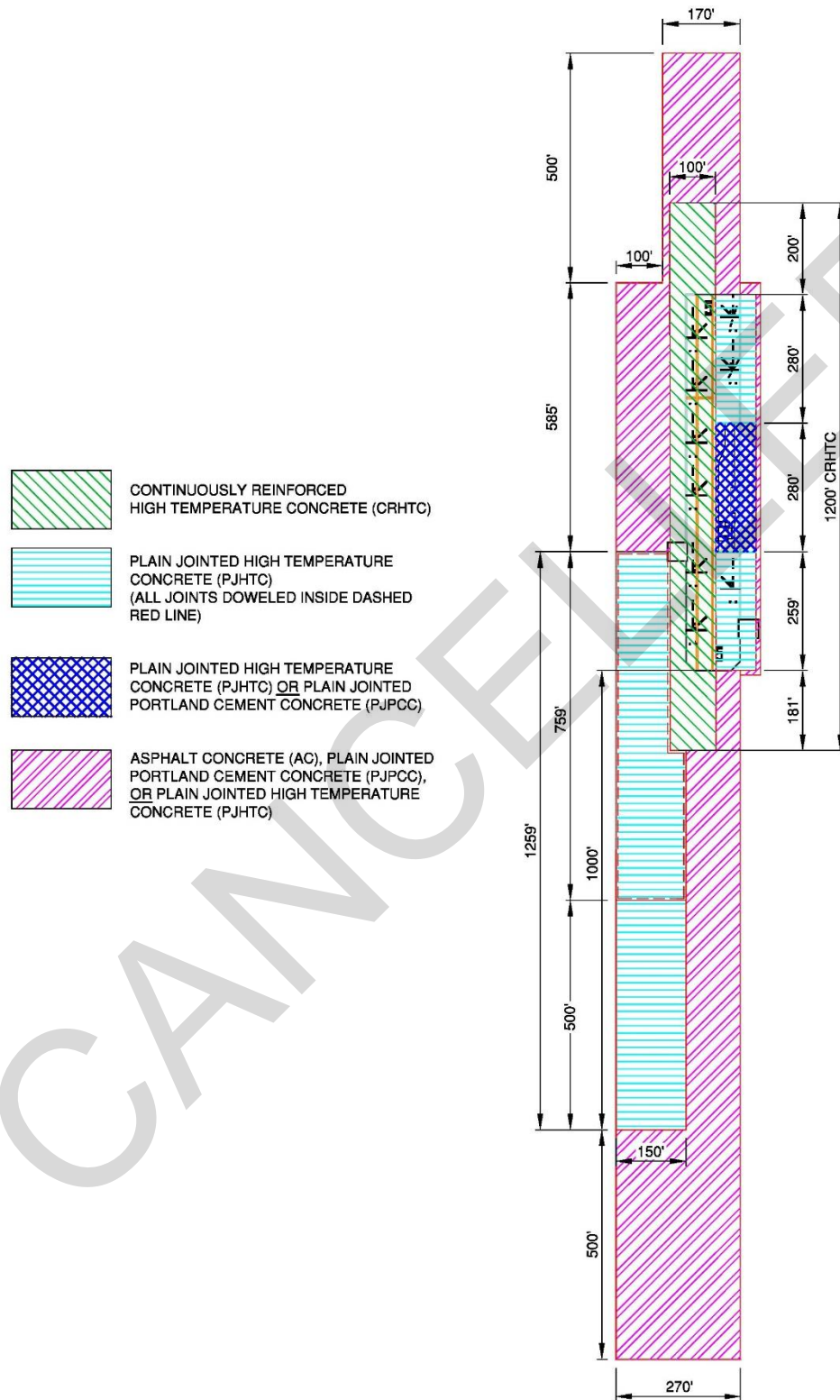
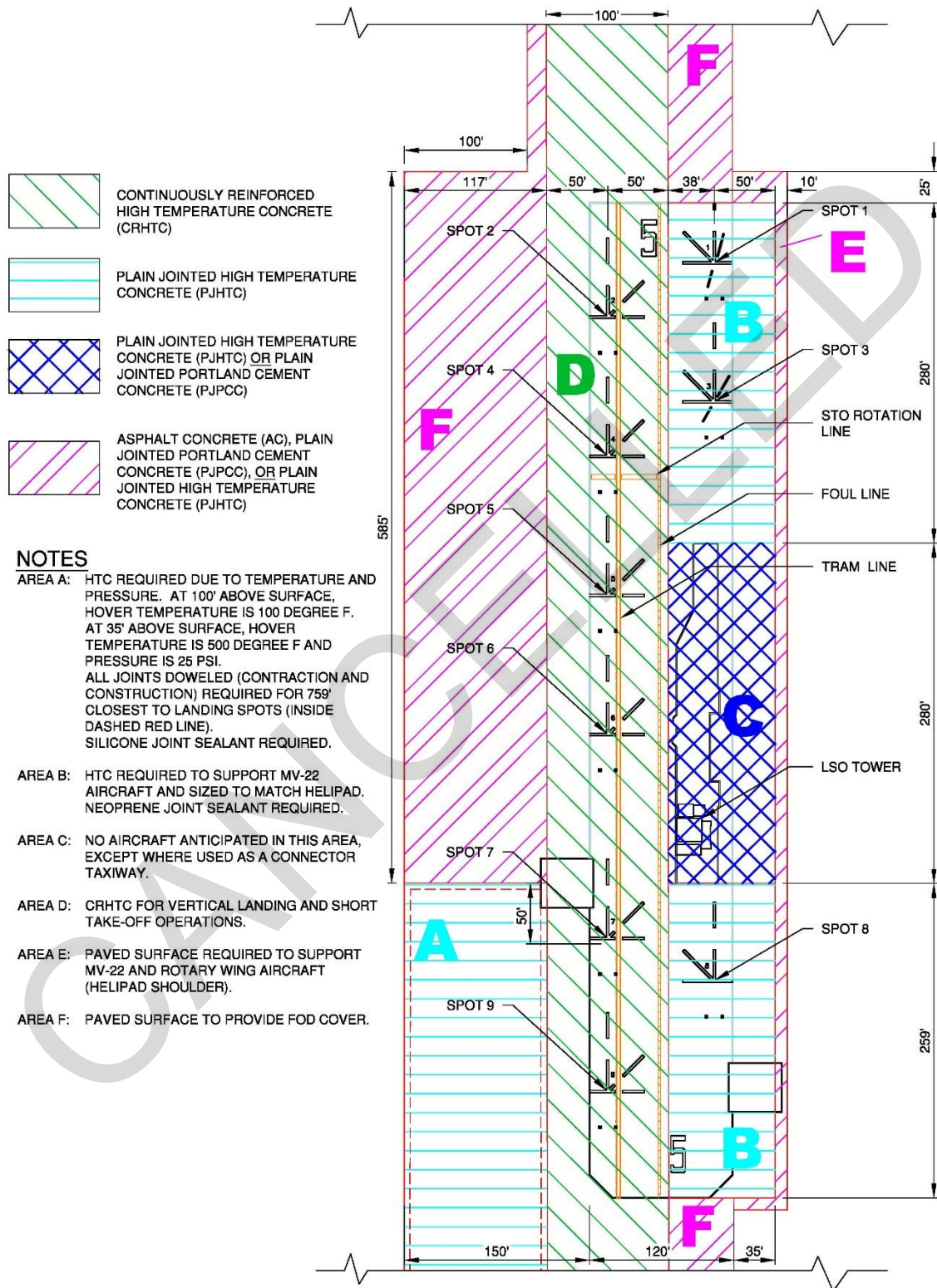

Figure 8-22. LHD Pavement Surface Types Detail





## **8-5 F-35B VERTICAL LANDING (VL) PADS.**

### **8-5.1 VL Pad Concept.**

The vertical landing pads are located at main air base facilities or forward operating bases. They are positioned at these facilities to provide proficiency training and flexibility for degraded aircraft system recovery. Though not prohibited, the STOVL design of the F-35B aircraft was not intended for routine vertical takeoffs from VL pads. Instead the follow-on takeoff from an airfield with a VL pad will be a conventional or short takeoff based on the facilities available. For this reason, the approach surfaces will be the focus of obstacle clearance considerations for the VL pad. Departure surfaces are not considered because vertical takeoffs are not performed. When the VL pad is collocated with an existing DoD airfield or FOB STOVL training facility and their respective imaginary surfaces overlap, the most restrictive or lower surface will be utilized to ensure obstacle clearance.

### **8-5.2 VL Pad Standard Drawings.**

NAVFAC Vertical Landing Pad (VLP) Standard Drawings have been developed for this facility type. These include NAVFAC Drawing Numbers 14064454 through 14064465 and are available from (<http://www.wbdg.org/ffc/dod/unified-facilities-criteria-ufc/ufc-3-260-01>), where this UFC is posted. Designer of Record must site-adapt, complete, and validate final design for construction. The original concept was developed for F-35B training; however, the design has been adapted to be compatible with rotary-wing aircraft operations also. These modifications include adjusting the approach surface to match the helipad criteria. Existing facilities constructed prior to these modifications may need to be evaluated if such operational upgrades are desired.

### **8-5.3 VL Pad Background.**

Vertical landing pads are located at main air base facilities or forward operating bases. They are positioned at these facilities to provide proficiency training and flexibility for degraded aircraft system recovery. Though not prohibited, the STOVL design of the F-35B aircraft was not intended for routine vertical takeoffs from VL pads. Instead the follow-on takeoff from a VL pad equipped facility will be a conventional or short takeoff based on the facilities available. For this reason, the approach surfaces will be the focus of obstacle clearance considerations for the VL pad. When the VL pad is collocated with an existing DoD airfield or FOB STOVL training facility and their respective imaginary surfaces overlap, the most restrictive or lower surface will be utilized to ensure obstacle clearance.

#### **8-5.3.1 Assumptions.**

- Airspace imaginary surfaces are defined for a standalone facility. When the VL pad is collocated with an existing DoD airfield or FOB STOVL facility and their respective imaginary surfaces overlap, the most restrictive or lower surface will be utilized to ensure obstacle clearance.

- The imaginary surfaces for the VL pad provide obstacle clearance for the F-35B to approach the VL pad for a day or night landing under VMC. The supporting landing pattern altitude defines the inner horizontal surface and transitional area elevations. An overhead entry or straight-in visual approach will be the entry maneuver for the VL pad visual pattern, and the obstacle clearance needed for these maneuvers define the approach surface requirements.
- The VL pad is considered a directional facility with a fixed approach direction. When departures are planned from the VL pad the vertical takeoff altitude will exceed the inner horizontal surface elevation before the start of the departure transition ensuring obstacle clearance requirements are met.
- VFR operations under visual meteorological conditions will be assumed at the vertical landing pad for training and simulated mission profiles.
- A 300-foot primary surface width is used for the VL pad because all recoveries (landings) will be conducted under VMC, with slow approach speeds, and the terminal phase resulting in a hover. This primary surface width is consistent with rotary-wing criteria conducting similar approach profiles.

#### **8-5.4 VL Pad Geometry.**

##### **8-5.4.1 Pad and Safety Zone Descriptions.**

Figures 8-23 through 8-27 and Table 8-4 provide dimensional criteria for layout and design of the VL pad and safety zones. The VL pad and safety zones are provided to prevent erosion of graded surfaces by jet blast from aircraft transition to/from the pad and surface water runoff. Each zone or surface contains a brief description of their use and reference to where their specific dimension or graphic is located within the document.

##### **8-5.4.2 Size.**

Table 8-4 provides the overall size of the vertical landing pad. In general terms and dimension the vertical landing pad will be constructed as a single square surface to the dimensions presented here.

##### **8-5.4.3 Shoulder Width.**

Table 8-4 provides the width of the paved shoulder that surrounds the vertical landing pad. This dimension reflects the width required to maintain a visual transition from approach to stabilized hover over the pad. The shoulder width provides safety buffer against approach altitude deviations creating FOD debris on the intended point of landing, and protection against erosion of the graded unpaved surface surrounding the VL pad.

#### 8-5.4.4 Grading.

Table 8-4 provides the grade constraints to insure surface water runoff. A uniform surface is required to eliminate irregularities between landing gear at touchdown. For this reason, the vertical landing pad will be sloped in one direction. After construction and prior to aircraft operations, each VL Pad will be surveyed on a 10' x 10' grid to determine elevations to the nearest 0.01'. This data will be analyzed using the procedures outlined in DM#315235 "Vertical Landing Pad Certification Requirements and Analysis" to verify the relative smoothness and certify the pads as "Authorized Level". If the pad does not meet the "Authorized Level" requirements, surface diamond grinding will be used to create a smooth surface with a consistent slope. The detailed requirements for conducting a pad levelness survey can be provided by the F-35 JPO. The purpose of the survey is to obtain measurements for analysis to verify that pad levelness and flatness complies with F-35B Flight Series Data (FSD). Post construction VL pad survey data should be sent to [Lightning.Support.Team@jsf.mil](mailto:Lightning.Support.Team@jsf.mil) for analysis. Analysis results will be provided to the requestor. Additionally, data, analysis, and results for all pads analyzed by the Lightning Support Team (LST) will be retained and archived for future reference; they may be found at DM#315485. Contact the F-35 JPO and Naval Air Surface Warfare Center Aircraft Division (NAWCAD) AR-6.7.8.2 NAVAIR Aviation Shore Facility Integration Branch for additional information on this subject.

- **Raised Elevation.** To ensure an elevation that will allow future grinding of the HTC surface, the VL pad and safety zone must be constructed together such that up to 51 millimeters (2 inches) of material may be diamond-ground from the landing pad surface and still maintain the maximum and minimum grades to eliminate ponding. This higher elevation of the VL pad must be transitioned to the safety zone on all sides, using slopes as indicated in Table 8-4.
- **Primary Surface Elevation.** The primary surface elevation is the highest point on a VL pad. The designer will verify that the primary surface of a VL pad does not interfere with the primary surface and other clearances of adjacent runways, aprons, or taxiways.
- **Grades Within Primary Surface.** Exclusive of pavement and shoulders, grades within the primary surface must be at least two percent to a maximum of five percent, prior to drainage channelization; however, the channel bottom may be flat. The balance of the area is to be clear of obstructions and rough-graded to the extent necessary to minimize damage to aircraft in the event of an emergency landing. For VLZs, the grade requirements apply to the entire primary surface.

#### 8-5.5 VL Pad Separation Distances.

VL pads may be constructed as stand-alone facilities. If co-located at a Class A or Class B airfield, plan for taxiways that provide VL pad access. Table 8-4 provides the minimum separation distances between permanent fixed-wing runways and vertical landing pads for simultaneous VFR operations. Table 8-4 provides the minimum

separation distances between permanent fixed-wing runways and vertical landing pads for non-simultaneous VFR operations. Vertical landing pads, paved safety zones, paved shoulders, and unpaved shoulders will be located outside all taxiway clearance distances.

### **8-5.6 VL Pad Clear Zones, Imaginary Surfaces, and APZs.**

Figures 8-25 and 8-26, and Tables 8-5 and 8-6 provide applicable clearances and grade controls for a reasonable level of safety. Their description and layout are similar to other STOVL facility and airfield types and are not unique to the vertical landing pad. Each zone or surface contains a brief description of their use and reference to where their specific dimension or graphic is located within the document. VL Pad Clear Zones and Imaginary Surfaces on the approach-departure path are compatible with rotary-wing (helipad) surfaces defined in Chapter 4. For only F-35B operations, the 2:1 Transitional Surface may be applied on all sides of the VL Pad and the ADCS will start at the edge of the Transitional Surface. See Figure 8-27 for an illustration of this configuration.

#### **8-5.6.1 Clear Zones.**

Clear zones are areas on the ground, located at the ends of the primary surface, along the approach-departure path of the VL pad. They possess a high potential for accidents and their use is restricted to be compatible with aircraft operations. VL pad clear zones are required and should be government owned or protected under long term lease. The clear zone will be cleared, graded and free of aboveground objects. See Table 8-9.

#### **8-5.6.2 Imaginary Surfaces.**

Surfaces in space established around a vertical landing pad that are designed to protect the airspace around the pad from encroachment and insure obstacle clearance. The imaginary surfaces for the vertical landing pad are the primary surface, transitional surface, inner horizontal surface, and approach-departure path surfaces. The lower approach-departure clearance surface (ADCS) will begin at edge of the primary surface. The upper ADCS will begin at the top of the lower ADCS. Both ADCS surfaces extend outward along the centerline of the approach or departure path. See Table 8-8.

#### **8-5.6.3 Accident Potential Zones.**

A land use control area beyond the clear zone of a vertical landing pad that possesses a significant potential for accidents, and their use is restricted in accordance with DoDI 4165.57. Their dimensions and layout are listed in Table 8-9. Navy planners will use OPNAVINST 11010.36C/MCO 11010.16 (or latest version) to determine specific AICUZ requirements. For the Air Force, land use guidelines within the clear zone (beyond the graded area) and APZ I and APZ II are provided in AFI 32-7063 and AFH 32-7084.

### **8-5.7 VL Pad Pavement Marking.**

Apply markings to VL Pads using reflective airfield marking paint, following the general scheme shown in Figure 8-28. See NAVFAC Vertical Landing Pad (VLP) Standard Drawings for specific layout and detailed dimensions.

**8-5.7.1 Diagonal Line-up Cue Markings.**

Paved pads 1.5m x 1.5m (5 ft x 5 ft) will be constructed on the diagonals at 30m (100 ft) from the corners of the VL Pad Safety Zone to provide additional visual cues for pilots to line up over the VL Pads prior to descending. Pads will be at the same elevation as the surrounding turf and painted orange, as shown in Figure 8-28.

**8-5.8 VL Pad Lighting.**

Install edge lights on the VL Pad and the connector taxiway, following the general scheme shown in Figure 8-29. See NAVFAC Vertical Landing Pad (VLP) Standard Drawings for detailed light layout and installation details.

**8-5.9 VL Pad Pavement Surface Types.**

Figure 8-30 shows the pavement types needed for VL Pads. The vertical landing pad will be constructed using CRHTC. The surrounding Paved Safety Zone will be constructed with PJHTC. The taxiway within 50-ft adjacent to the VL Pad will be constructed with PJHTC. The taxiway connecting to adjacent runway or taxiway may be constructed with PJPCC or Hot Mix Asphalt. The paved shoulders will be constructed with PJPCC or HMA. Regardless of construction material or method, the vertical landing surface will have a smooth transition to surrounding safety zones, shoulders, and taxiways. The paved safety zone pavement thickness will be designed in accordance with UFC 3-260-02, as Traffic Area B, for 2,500 passes of an F-35B aircraft loaded at 61,500 pounds. Seal joints in PJHTC with neoprene or silicone sealant.

**Table 8-4. Vertical Landing (VL) Pad Criteria**

Table 8-4. Vertical Landing (VL) Pad Criteria			
Item		Requirement	Remarks
No.	Description		
1	Size	30 m x 30 m (100 ft x 100 ft)	Same as a Standard VFR and IFR Helipad
2	Paved Safety Zone	15 m (50 ft)	<ul style="list-style-type: none"> <li>- Safety zones are provided to prevent erosion of graded surfaces by jet blast from aircraft transitioning to and from the VL facility.</li> <li>- The VL pad will be centered on the safety zone making the outside dimensions of the safety zone 61m x 61m (200 ft x 200 ft).</li> </ul>
3	Paved Shoulder	3 m (10 ft)	

Table 8-4. Vertical Landing (VL) Pad Criteria			
Item		Requirement	Remarks
No.	Description		
4	VL Pad Grade	Min. 0.5% Max. 0.87%	A uniform slope is required to eliminate irregularities between landing gear during touchdown. -Uniformly sloped in one direction in both the longitudinal and transverse directions. - The resultant effective grade will not exceed 1.5%. - Crowning or peaking of these paved areas will not be allowed. - The pavement design engineer will verify that all areas of vertical landing pads, paved safety zones, connecting taxiways, and paved and unpaved shoulders, effectively drain surface water.
5	Safety Zone Grade	Min 0.5% Max 1.0%	Uniformly slope in one direction in both the longitudinal and transverse direction.
6	Shoulder Grade	Min 2.0% Max 4.0%	Uniformly slope in one direction in both the longitudinal and transverse direction.
7	Vertical landing pad lateral clearance zone (corresponds to half the width of primary surface)	46.7 m (150 ft)	Supports VFR operations - Measured perpendicularly from centerline of vertical landing pad. This area is to be clear of fixed and mobile obstacles. In addition to the lateral clearance criterion, the vertical height restriction on structures and parked aircraft as a result of the transitional slope must be taken into account. - Fixed obstacles include man-made or natural features constituting possible hazards to moving aircraft.
8	Grades within runway lateral clearance zone (Primary Surface)	Min 2.0% Max 5.0%	Does not apply to paved VL Pad, Safety Zone or Shoulder.  - Grades within the primary surface must be at least two percent to a maximum of five percent, prior to drainage channelization; however, the channel bottom may be flat. Avoid abrupt changes or sudden reversals. - The balance of the area is to be clear of obstructions and rough-graded to the extent necessary to minimize damage to aircraft in the event of an emergency landing. Grade requirements apply to the entire primary surface.
9	Distance from centerline of fixed-wing runway to the centerline of the vertical landing pad	Min 213.36 m (700 ft)	Simultaneous VFR operations for Class A runway for Air Force, Navy and Marine Corps.
		Min 304.8 m (1,000 ft)	Simultaneous VFR operations for Class B runway for Air Force, Navy and Marine Corps.
		Min 60.96 m (200 ft)	For non-simultaneous VFR and IFR operations. - Distance may be reduced to 60.96 m (200 ft); however, waiver must be based on wake-turbulence and jet blast. - Operations for Class B runway for Air Force, Navy and Marine Corps, vertical landing pads may be sited within the runway primary surface, but must remain a distance from the runway edge equal to the distance the runway hold position markings are located.
		Min. 762.00 m (2,500 ft)	IFR using simultaneous operations (depart-depart) (depart-approach).

Table 8-4. Vertical Landing (VL) Pad Criteria			
Item		Requirement	Remarks
No.	Description		
		Min. 1,310.64 m (4,300 ft)	IFR using simultaneous approaches.
10	Connecting Taxiway Width	22.8 m (75 ft)	The connecting taxiway must be long enough so that after an aircraft has landed and is on the VL pad, it does not interfere with aircraft operations on the runway, taxiway or apron to which the VLZ is connected.
11	Connecting Taxiway Total Width of shoulders (paved and unpaved)	15 m (50 ft)	
12	Connecting Taxiway Paved Shoulder Width	3 m (10 ft)	
13	Connecting Taxiway Grades	See Table 5-1.	

**Table 8-5. Vertical Landing (VL) Pad Airspace Imaginary Surfaces**

Table 8-5. Vertical Landing Pad Airspace Imaginary Surfaces				
Item		Legend	Requirement	Remarks
No.	Description			
1	Primary surface width	A	93.5 m (300 ft)	Centered on vertical landing pad. - At US Navy and Marine Corps STOVL facilities where the lateral clearance was established according to previous criterion, that distance may remain.
2	Primary surface length	A	93.5 m (300 ft)	Centered on vertical landing pad. At US Navy and Marine Corps STOVL facilities where the lateral clearance was established according to previous criterion, that distance may remain.
3	Primary surface elevation	A	Elevation of VL pad.	The primary surface elevation is the highest point on a VL pad. The VL Pad primary surface must be at the same elevation or above the primary surface of adjacent runways. The designer will verify that the primary surface of a VL pad does not interfere with the primary surface and other clearances of adjacent runways, aprons, or taxiways.

Table 8-5. Vertical Landing Pad Airspace Imaginary Surfaces

Item		Legend	Requirement	Remarks
No.	Description			
4	Grade of Clear Zone in any direction	B	5.0% Max.	The clear zone starts at the end of the primary surface and has the same width as the primary surface (93.5 m [300 ft]), with a length of 400 ft. - Clear zones are areas on the ground, located at the ends of the primary surface, centered on the primary approach path to the VL pad. - Areas to be free of obstructions. Rough grade and turf when required. Positive drainage to avoid standing water.
5	Start of Lower approach-departure Surface	C	45.72 m (150 ft)	Measured from the center of the VL Pad along the primary approach path.
6	Length of sloped Lower approach-departure surface	C	365.7 m (1,200 ft)	Measured horizontally along the extended approach path. - This approach length reflects obstacle clearance requirements for STOVL or rotary aircraft to make a straight decelerating transition to the intended point of landing.
7	Slope of Lower approach-departure surface	C	8:1	Slope ratio is horizontal: vertical.  Example: 8:1 is 8 m (ft) horizontal to 1 m (ft) vertical.
8	Width of Lower approach-departure surface at start of sloped portion	C	91.44 m (300 ft)	- Centered on the extended centerline of the approach path and at the primary surface. - At US Navy and Marine Corps VTSOL facilities where the lateral clearance was established according to previous criterion, that distance may remain.
9	Width of Lower approach-departure surface at end of sloped portion	C	274.3 m (900 ft)	- Perpendicular to the extended centerline of the approach path. - At US Navy and Marine Corps VTSOL facilities where the lateral clearance was established according to previous criterion, that distance may remain.



Table 8-5. Vertical Landing Pad Airspace Imaginary Surfaces

Item		Legend	Requirement	Remarks
No.	Description			
10	Elevation of Lower approach-departure surface at start of sloped portion	C	Elevation of VL Pad	
11	Elevation of Lower approach-departure surface at end of sloped portion	C	45.7 m (150 ft)	Measured up from the primary surface.
12	Start of Upper approach-departure Surface	D	365.7 m (1,200 ft)	Measured from the center of the VL Pad along the primary approach path. It starts at the top of the Lower Approach Surface.
13	Length of sloped Upper approach-departure surface	D	4,267 m (14,000 ft)	Measured horizontally along the extended approach path. - This approach length reflects obstacle clearance requirements for the STOVL aircraft to make a straight decelerating transition to the intended point of landing. - This is the horizontal distance required to extend from the top of the Lower Approach Surface to 500 ft AGL.
14	Slope of Upper approach-departure surface	D	40:1	Slope ratio is horizontal: vertical.  Example: 40:1 is 40 m (ft) horizontal to 1 m (ft) vertical.
15	Width of Upper approach-departure surface at start of sloped portion	D	274.3 m (900 ft)	- Centered on the extended centerline of the approach path and starts at the top of the 2:1 transitional slope. This distance spans the full width along the top of the transition surface. - At US Navy and Marine Corps VTSOL facilities where the lateral clearance was established according to previous criterion, that distance may remain.

Table 8-5. Vertical Landing Pad Airspace Imaginary Surfaces

Item		Legend	Requirement	Remarks
No.	Description			
16	Width of Upper approach-departure surface at end of sloped portion	D	914.4 m (3,000 ft)	<ul style="list-style-type: none"> <li>- Perpendicular to the extended centerline of the approach path.</li> <li>- The 1000:75 width ratio is horizontal length: horizontal width. This ratio is consistent with class-A VFR runway requirements.</li> <li>- At US Navy and Marine Corps VTSOL facilities where the lateral clearance was established according to previous criterion, that distance may remain.</li> </ul>
17	Elevation of Upper approach-departure surface at start of sloped portion	D	45.7 m (150 ft)	<ul style="list-style-type: none"> <li>- Measured up from the primary surface elevation to the top of the 8:1 approach surface.</li> <li>- This start elevation reflects the requirement for the STOVL aircraft to remain above 150 ft AGL until over the intended point of landing.</li> </ul>
18	Elevation of Upper approach-departure surface at end of sloped portion	D	152.4 m (500 ft)	Measured from the edge of VL pad on approach centerline.
19	Radius of inner horizontal surface	E	1,869 m (6,000 ft)	<p>An imaginary surface constructed by scribing a 180-degree (or more for multiple approaches) arc with a radius of 1,869 m (6,000 ft) from the center of the VL pad.</p> <p>-This imaginary surface covers the VFR landing pattern obstacle clearance requirements.</p>
20	Width between outer edges of inner horizontal surface	E	3,738 m (12,000 ft)	
21	Elevation of inner horizontal surface	E	45.72 m (150 ft)	<p>Measured up from the elevation of the VL Pad Primary Surface.</p> <p>Exception: When the VL Pad is adjacent to an airfield, the inner horizontal surface is established to match the adjacent airfield's inner horizontal surface.</p>
22	Start of transitional surface	H	45.72 m (150 ft)	Measured perpendicularly from centerline of the approach path and extended centerline of Vertical Landing pad (coincident with edge of Primary Surface).

**Table 8-5. Vertical Landing Pad Airspace Imaginary Surfaces**

Item		Legend	Requirement	Remarks
No.	Description			
23	End of transitional surface	H	Various	The transitional surface ends at the inner horizontal surface, at an elevation of 45.72 m (150 ft). See NOTE 1.
24	Slope of transitional surfaces	H	2:1	Slope ratio is horizontal: vertical. 2:1 is 2 m (ft) horizontal to 1 m (ft) vertical. Vertical height of vegetation and other fixed or mobile obstacles and/or structures will not penetrate the transitional surface. - For Navy and Marine Corps airfields, taxiway pavements are exempt from this requirement. - For the USAF, the air traffic control tower is exempt from this requirement if the height will not affect TERPS criteria.

**NOTES:**

1. When the vertical landing pad is located within the boundaries of an existing DoD airfield and the imaginary surfaces of the two facilities overlap, the vertical landing pad transitional surface elevation will extend to meet the existing inner horizontal surface elevation of the DoD airfield. The vertical landing pad imaginary surface requirements may be waived provided the existing DoD airfield imaginary surfaces meet or exceed the obstacle clearance requirements defined by the imaginary surfaces in Table 8-8.
2. When the vertical landing pad is located within the primary surface of the existing DoD runway, use of the runway approach/departure surface may suffice for the vertical landing pad approach surface provided a visual transition between the path and the vertical landing pad can be conducted while under VMC conditions.

**Table 8-6. Vertical Landing (VL) Pad Clear Zone and APZs**

Item		Legend	Requirement	Remarks
No.	Description			
1	Clear Zone	B	Length: 121.90m (400 ft)  Width: 91.44m (300 ft)	Length measured along the extended primary approach path.  Width measured perpendicular to the primary approach path.
2	APZ I	J	Length: 243.83m (800 ft)  Width: 91.44m (300 ft)	APZ I starts at the end of the clear zone, and is centered on the primary approach path.  Width measured perpendicular to the primary approach path.

Figure 8-23. Vertical Landing (VL) Pad Facility Outline with Safety Zones

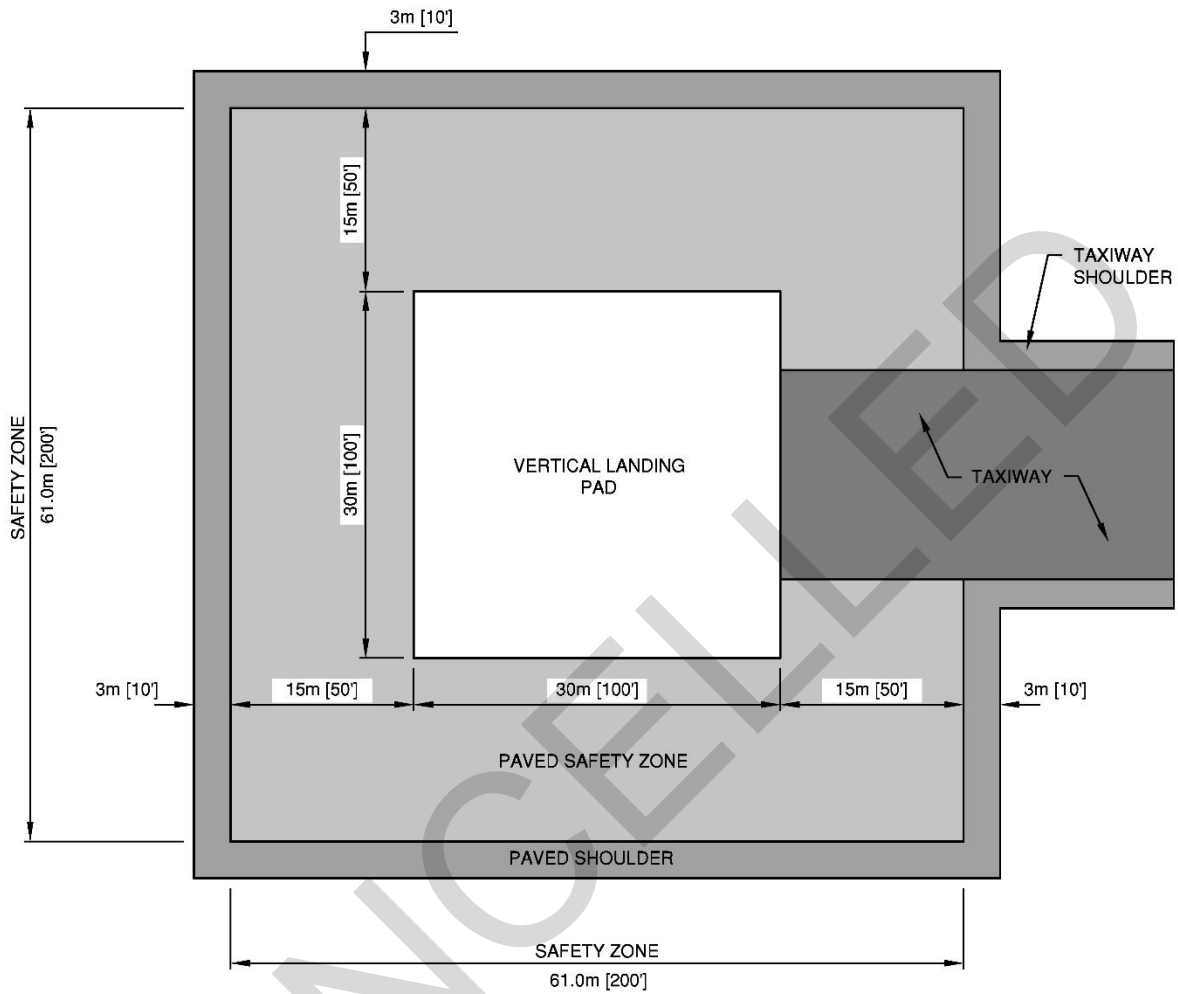

Figure 8-24. Vertical Landing (VL) Pad Facility Cross Section Gradient

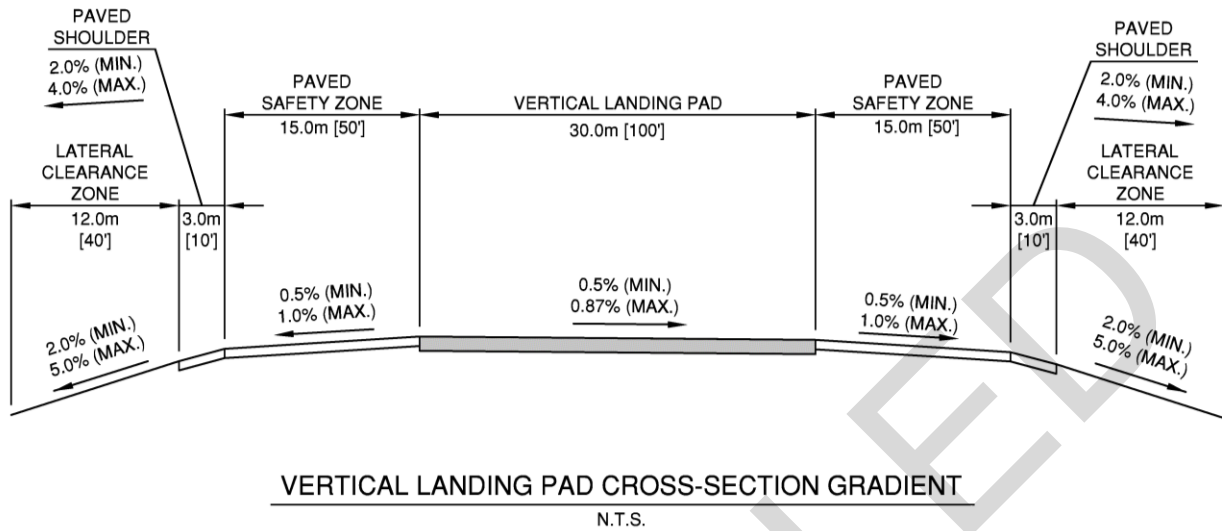
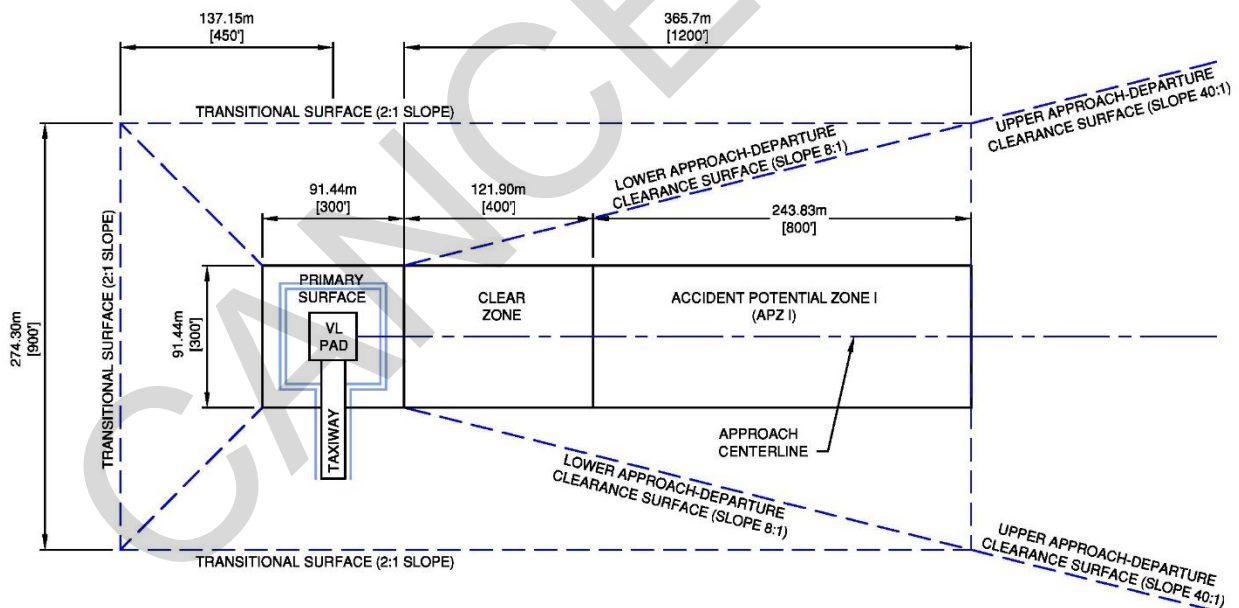

Figure 8-25. Vertical Landing (VL) Pad Facility Clear Zone and Accident Potential Zone



**NOTES**

1. APPROACH CENTERLINE CAN BE PLANNED FROM ANY DIRECTION TO THE VL PAD.
2. MULTIPLE APPROACH (OR WAVE-OFF/DEPARTURE) CENTERLINES MAY BE PLANNED FOR A VL PAD.

Figure 8-26. Vertical Landing (VL) Pad Approach Surface Isometric

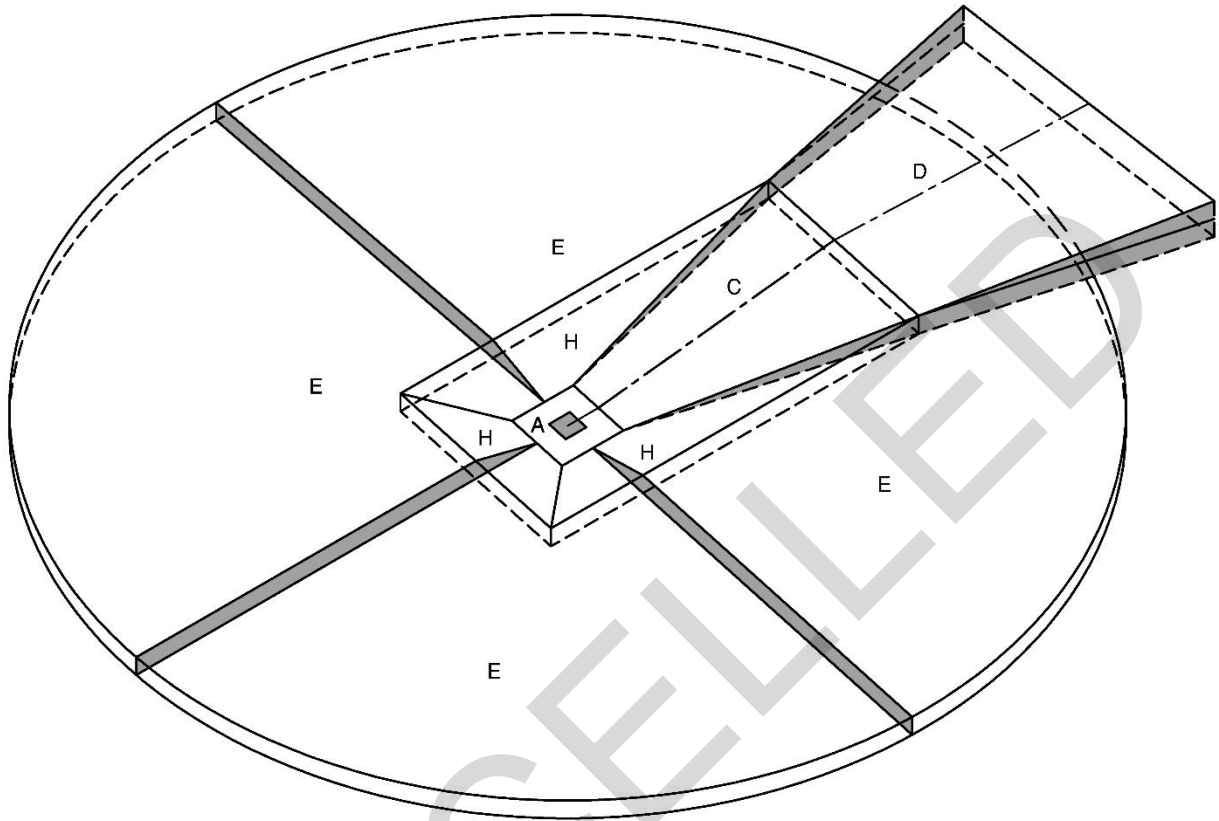

**LEGEND**

- A PRIMARY SURFACE
- B CLEAR ZONE SURFACE (NOT SHOWN)
- C LOWER APPROACH-DEPARTURE CLEARANCE SURFACE (8:1 SLOPE RATIO)
- D UPPER APPROACH-DEPARTURE CLEARANCE SURFACE (40:1 SLOPE RATIO)
- E INNER HORIZONTAL SURFACE (45.72m [150'] ELEVATION)
- F NOT USED
- G NOT USED
- H TRANSITIONAL SURFACE (2:1 SLOPE RATIO)
- I NOT USED
- J ACCIDENT POTENTIAL ZONE (APZ) (NOT SHOWN)

**NOTES**

1. AIRSPACE IS DEFINED FOR APPROACHES ONLY, NOT DEPARTURES.
2. APPROACH CENTERLINE MAY BE FROM ANY DIRECTION TO THE VL PAD.
3. MULTIPLE APPROACH (OR WAVE-OFF/DEPARTURE) CENTERLINES MAY BE DEFINED.

Figure 8-27. Vertical Landing (VL) Pad Facility Clear Zone and Accident Potential Zone for F-35B Only

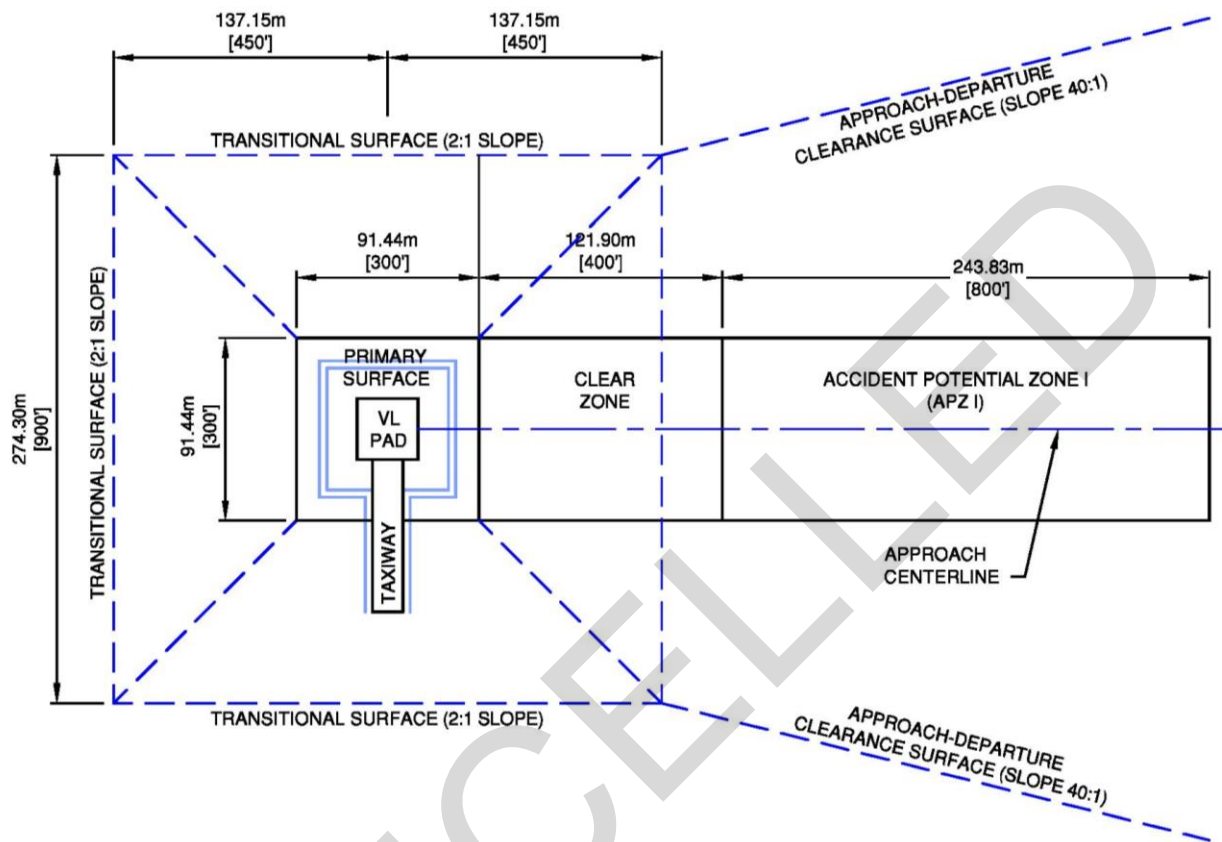

**NOTES**

1. APPROACH CENTERLINE CAN BE PLANNED FROM ANY DIRECTION TO THE VL PAD.
2. MULTIPLE APPROACH (OR WAVE-OFF/DEPARTURE) CENTERLINES MAY BE PLANNED FOR A VL PAD.

Figure 8-28. Vertical Landing (VL) Pad Markings

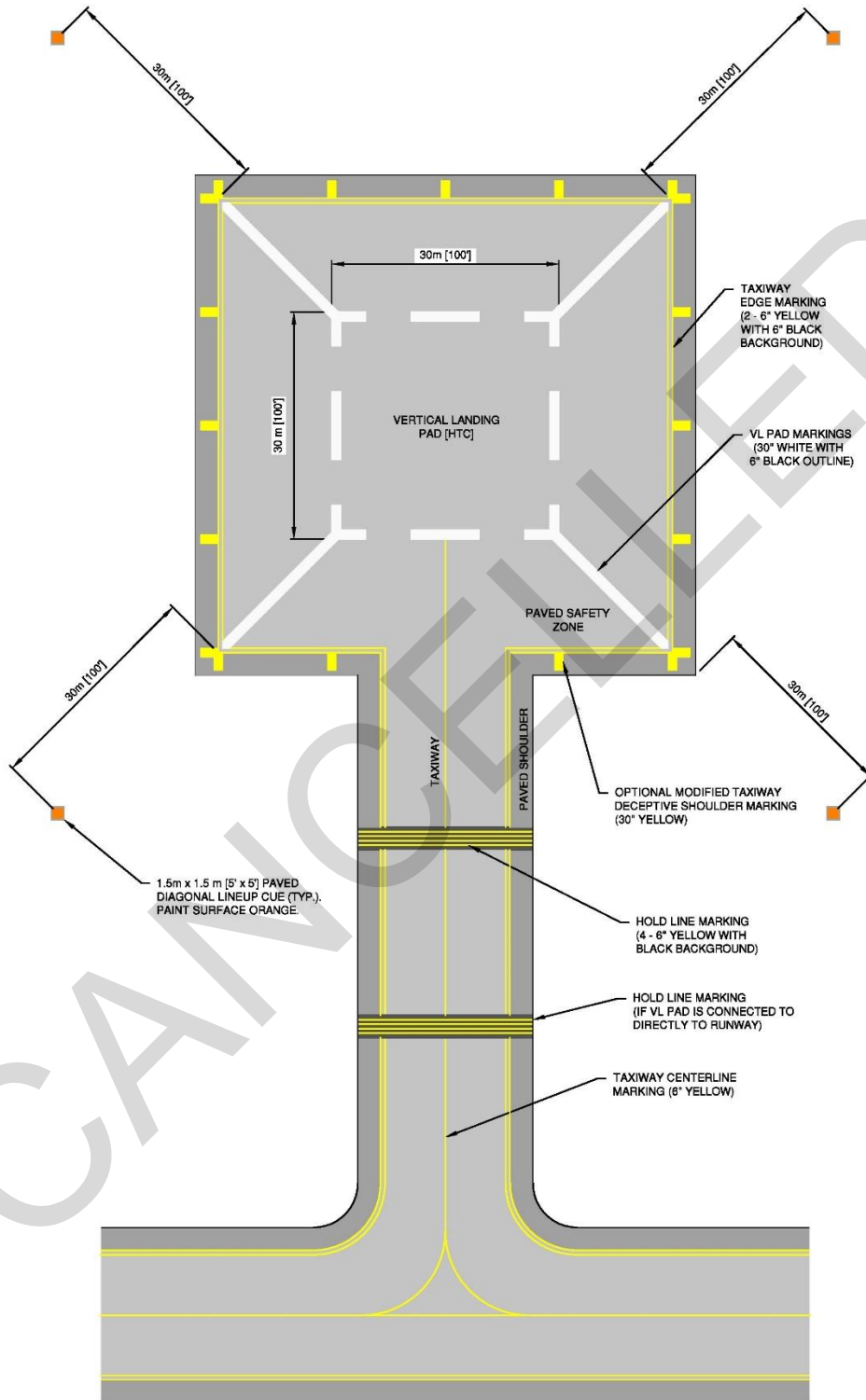



Figure 8-29. Vertical Landing (VL) Pad Lighting

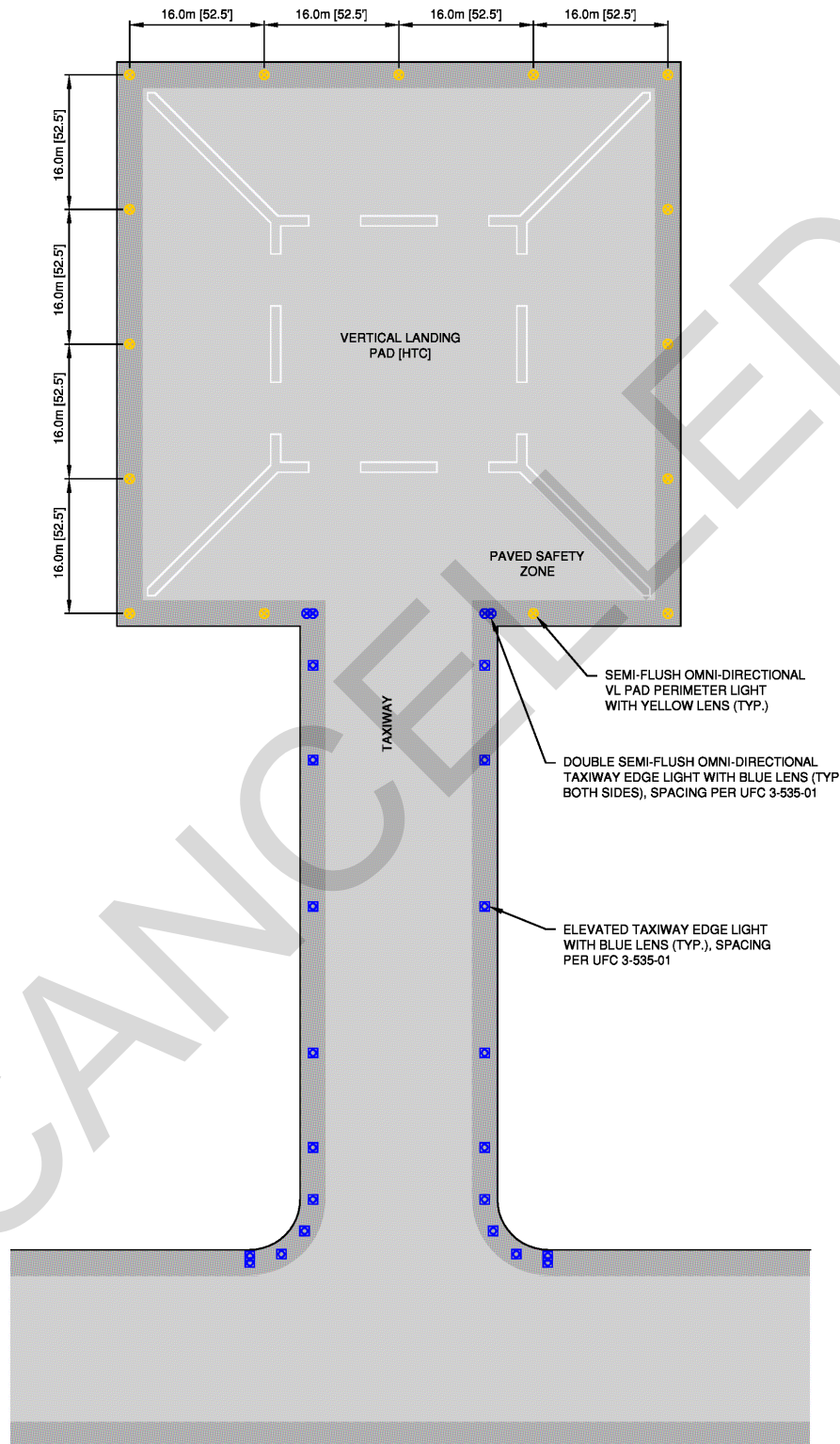
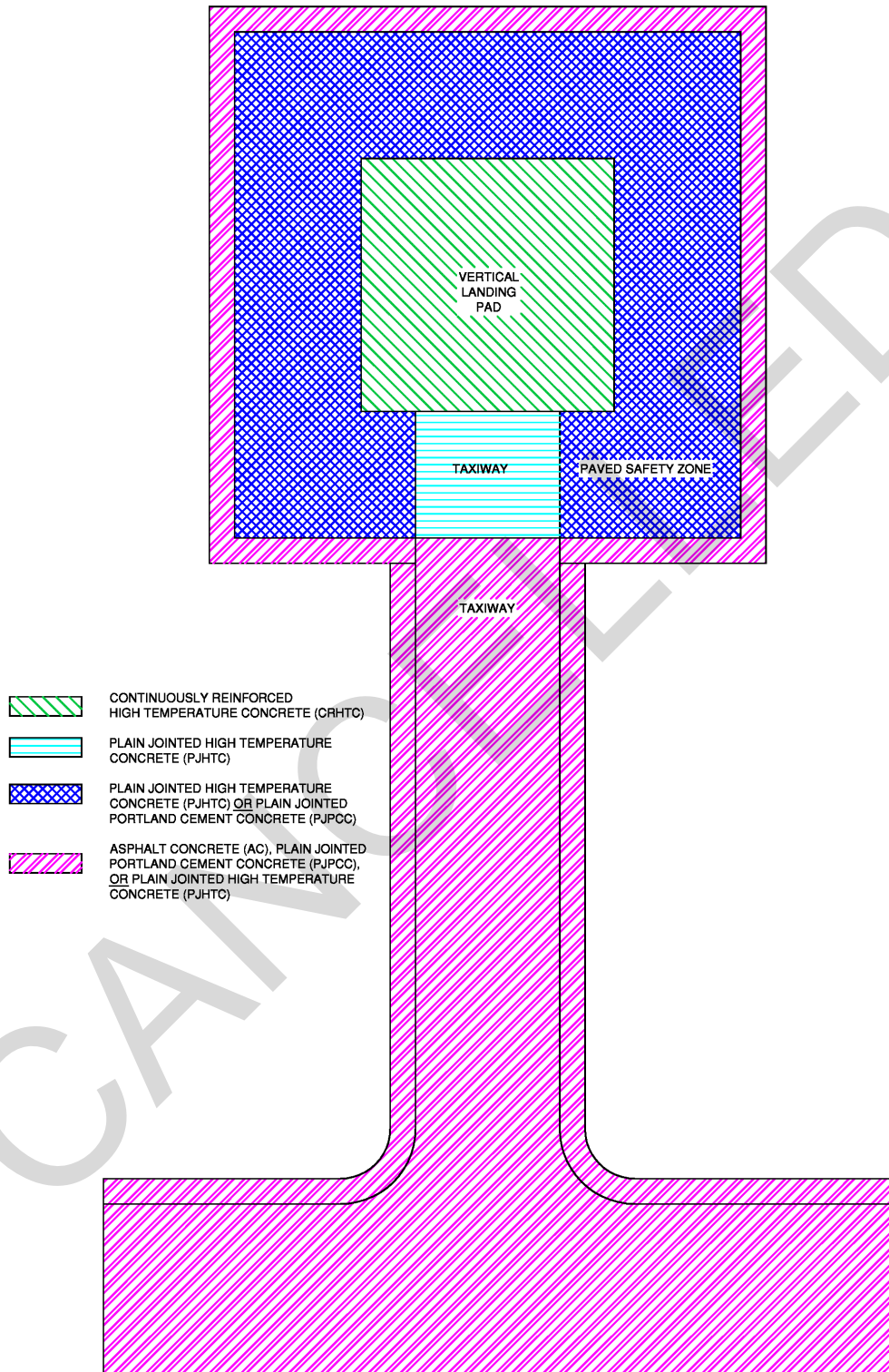

Figure 8-30. VL Pad Pavement Surface Types



## **8-6 FORWARD OPERATING BASE (FOB) STOVL FACILITY.**

### **8-6.1 FOB Concept.**

At some locations, STOVL Forward Operating Base training has incorporated the use of secondary roads or taxiways to support FOB mission Training and Readiness qualification requirements. The size and structure of these facilities varies slightly from location to location; however, in general terms the facility would be narrower and shorter than a standard Class A or B runway. The primary focus of these training evolutions is the training objectives for the pilots and Landing Site Supervisors (LSSs). The primary landing at a FOB in support of those objectives is a precision Rolling Vertical Landing (RVL) with a typical approach speed of 60 knots. The acceptable tolerances for a precision RVL are significantly tighter than the typical RVL flown to a Class B runway. To afford the proper visual cuing and reinforcement of the established tolerances for the FOB training facility the criteria for the C-130 landing zone (60 ft x 3000 ft runway) and similar obstacle clearances are used. The use of these criteria is applicable because the FOB operations will be conducted under Visual Flight Rules and while under the control of a LSS. Use of these accepted criteria has real world applications where FOBs are set up as ground loiter points based on mission necessity and not the availability of host nation airfields. These mission-critical ground loiter points may or may not meet typical obstacle clearance criteria; however, they are robust enough to insure the aviation commander sufficient margin for safe and efficient aircraft operations.

### **8-6.2 FOB Standard Drawings.**

No standard drawings have been developed for FOB facilities. The criteria provided in this chapter must be site-adapted to the proposed location.

### **8-6.3 FOB Background.**

STOVL Forward Operating Base training varies slightly from location to location; however, in general terms the facility would be narrower and shorter than a standard Class A or B runway. The primary focus of these training evolutions is the training objectives for the pilots and Landing Site Supervisors (LSSs). The primary landing at a FOB in support of those objectives is a precision Rolling Vertical Landing (RVL) with a typical approach speed of 150 knots, landing at approximately 60 knots. The acceptable tolerances for a precision RVL are significantly tighter than the typical RVL flown to a Class B runway. To afford the proper visual cuing and reinforcement of the established tolerances for the FOB training facility the criteria for the C-130 landing zone (60 ft x 3000 ft runway) and similar obstacle clearances are used. The use of these criteria is applicable because the FOB operations will be conducted under Visual Meteorological Conditions and while under the control of a landing site supervisor. Use of these accepted criteria has real world applications where FOBs are set up as ground loiter points based on mission necessity and not the availability of host nation airfields. These mission-critical ground loiter points may or may not meet typical obstacle clearance criteria, however are robust enough to insure the aviation commander sufficient margin for safe and efficient aircraft operations.

### 8-6.3.1 Assumptions.

- Airspace imaginary surfaces are defined for a standalone training facility. When the FOB STOVL facility is collocated with an existing DoD airfield and their respective imaginary surfaces overlap, the most restrictive or lower surface will be utilized to ensure obstacle clearance.
- The imaginary surfaces for the FOB STOVL facility provide obstacle clearance for the F-35B day/night visual pattern. The FOB visual landing pattern altitude defines the inner horizontal surface and transitional area elevations. An overhead entry or straight-in visual approach will be the entry maneuver for the FOB visual pattern, and the obstacle clearance needed for these maneuvers define the approach and departure path requirements. These definitions are presented similar to the existing Class B runway criteria.
- A 300-foot primary surface width is used for the FOB STOVL facility because all recoveries will be conducted under VMC and the close supervision of a Landing Site Supervisor.
- Airspace imaginary surfaces extend 1.5 nm abeam and 3.3 nm approach-departure path to support obstacle clearance for aircraft within the landing pattern or maneuvering to a 3 nm initial.

### 8-6.4 FOB Geometry.

#### 8-6.4.1 Runway, Overrun, and Safety Zone Descriptions.

Figures 8-31 through 8-41, and Table 8-7 provide dimensional criteria for the layout and design of the FOB runway, overruns, and safety zones. The FOB runway should be considered bi-directional unless specifically limited to a single approach and departure path. Overruns and shoulders are provided as safety zones to prevent erosion of graded surfaces by jet blast from aircraft and surface water runoff, and to provide a smooth transition from paved to unpaved surface. Runway shoulders are not required in cases where the runway width meets or exceeds the combined total widths for the runway and shoulders defined in this document. Each zone or surface contains a brief description of their use and reference to where their specific dimension or graphic is located within the document.

#### 8-6.4.2 Runway Length.

Table 8-7 provides the minimum length for the FOB runway. Training and operational facilities will be of various lengths based on facilities available, elevation, and supported mission.

#### 8-6.4.3 Runway Width.

Table 8-7 provides the minimum width for the FOB runway. Training and operational facilities will be of various widths based on facilities available and supported mission.

#### **8-6.4.4 Gradients of Operational Surfaces.**

Gradient constraints are based upon sufficient slope to insure surface water runoff. A uniform transverse slope is preferable to eliminate irregularities between landing gear at touchdown. For this reason, the FOB runway should be centerline crowned or the entire runway sloped in one direction. Either sloping scheme will provide the pilot with a consistent uniform surface adequate for touchdown. See Table 8-7.

#### **8-6.4.5 Overrun Length.**

Table 8-7 provides the length of the overrun for both the approach and departure ends. This length is dependent on the STO profile and the distance from the FOB runway where the profile reaches a minimum altitude of 150 ft AGL.

#### **8-6.4.6 Overrun Width.**

Table 8-7 provides the width of the overrun. This width, at a minimum, reflects the width of the FOB runway plus any shoulder width and will be centered on the extended runway centerline.

#### **8-6.4.7 Shoulder Length.**

Table 8-7 provides the length of the shoulder. This length is dependent on the length of the FOB runway and ties into the overrun on both ends of the FOB runway for one continuous surface.

#### **8-6.4.8 Shoulder Width.**

Table 8-7 provides the width of the shoulder. This width is designed to prevent soil erosion from jet blast or surface water runoff and provide a smooth transition to the graded unpaved shoulder areas.

#### **8-6.5 FOB Separation Distances.**

Table 8-7 provides the minimum separation distances between permanent runways/helipads and the FOB runway for simultaneous operations. Table 8-7 provides the minimum separation distances between permanent Class A or Class B Runways and FOB runway for non-simultaneous operations.

#### **8-6.6 FOB Clear Zones, Imaginary Surfaces, and APZs.**

Figures 8-35 through 8-39 and Tables 8-8 and 8-9 provide applicable clearances and grade controls for a reasonable level of safety. Their description and layout are similar to other airfield types and are not unique to the FOB runway or facility. Each zone or surface contains a brief description of their use and reference to where their specific dimension or graphic is located within the document.

##### **8-6.6.1 Clear Zones.**

Runway clear zones are areas on the ground, located at the ends of each runway. The FOB runway should be considered bi-directional unless specifically limited to a single approach and departure path. They possess a high potential for accidents, and their use is restricted to be compatible with aircraft operations. Runway clear zones are required for the runway and should be owned or protected under a long-term lease. See Table 8-9.

#### **8-6.6.2 Imaginary Surfaces.**

Surfaces in space established around a STOVL facility in relation to the FOB runway and designed to define the protected airspace around the STOVL facility. The imaginary surfaces for the FOB STOVL facilities are the primary surface, transitional surface, inner horizontal surface, conical surface, outer surface and approach-departure path surfaces. See Table 8-8.

#### **8-6.7 Accident Potential Zones.**

Accident Potential Zones of a STOVL facility that possesses a significant potential for accidents, and their use is restricted in accordance with DoDI 4165.57. Their dimensions and layout are listed in Table 8-9. Navy planners will use OPNAVINST 11010.36C/MCO 11010.16 (or latest version) to determine specific AICUZ requirements. For the Air Force, land use guidelines within the clear zone (beyond the graded area) and APZ I and APZ II are provided in AFI 32-7063 and AFH 32-7084.

#### **8-6.8 FOB Pavement Markings.**

No pavement markings are required for FOB STOVL Facilities; however, at locations where FOB STOVL facilities will be used for training or long-term operations, it is desirable to apply painted markings to the pavement surface to enhance safety. When needed, apply markings to FOB pavements using reflective airfield marking paint, following the general scheme shown in Figure 8-40.

##### **8-6.8.1 Threshold Bar.**

White threshold stripes may be marked at each end of the FOB runway to distinguish between the overrun and the FOB runway surface. The marking will be 1.2 meters (4 feet) wide and extend from edge to edge of the FOB runway surface.

##### **8-6.8.2 Edge Stripes.**

White side stripes should be painted when there is no visual distinction between the FOB runway surface and the paved shoulder (e.g. both FOB runway and shoulder are asphalt). Edge stripes will be 0.3 meter (1 foot) wide and extend along the entire length of the FOB runway.

##### **8-6.8.3 Taxiway Centerline.**

If the FOB runway has connecting taxiways, the taxiway centerline turn radius will not be extended onto the FOB runway surface.

#### **8-6.8.4 Taxiway, Apron and Turnaround Edge Stripes.**

If FOB STOVL facility taxiways, aprons or turnarounds have paved shoulders and there is no visual distinction between the edge of load-bearing pavement and the shoulder, the edge of full-strength pavement will be marked with two 152-millimeter (6-inch) wide yellow stripes separated by a 152-millimeter (6-inch) wide gap.

#### **8-6.8.5 Holding Position Marking.**

The holding position is located a minimum of 30.5 meters (100 feet) from the near edge of the FOB runway. This distance is measured perpendicular to the long axis of the runway. For holding position marking dimensions, see Service-specific airfield marking guidance.

#### **8-6.8.6 Touchdown Box Markings (Optional).**

When desired by the airfield manager, touchdown box markings may be applied. These markings consist of 0.9-meter (3-foot) -wide white stripes that extend transversely across the entire width of the runway surface. The stripes are located 30.5 meters and 152 meters (100 feet and 500 feet) from the approach end threshold.

#### **8-6.8.7 Runway Designation Markings.**

Runway designation markings will not be used on FOB runways.

#### **8-6.8.8 Runway Centerline (Optional).**

When desired by the airfield manager, runway centerline stripes may be applied. Stripes are 0.5 meter to 0.9 meter (1.5 feet to 3 feet) wide and 30.5 meters (100 feet) long, with an 18.3-meter (60-foot) gap between stripes.

#### **8-6.9 FOB Lighting.**

No airfield lighting is required for FOB STOVL Facilities; however, at locations where FOB STOVL facilities will be used for training or long-term operations, it is desirable to install edge light systems to enhance safety. When needed, install edge lights on the FOB STOVL Facility following the general scheme shown in Figure 8-41. See UFC 3-535-01 for lighting component details. Lighting layout generally follows the Chapter 7 AMP-1 Lighting Layout.

#### **8-6.10 FOB Pavement Surface Types.**

Figure 8-42 shows the pavement types needed for FOB Runway Facilities. Pavements on the FOB Runway must be constructed with PJPC. Life-cycle cost considerations should be used to determine whether CRPC is cost effective to reduce the number of pavement joints subjected to high pressures during takeoff operations and thereby

reduce future maintenance demands. Shoulder pavements may be constructed with PJPCC or HMA. Overruns will be designed to match the runway pavement. Special design consideration may be needed if the overrun is used as a taxiway or turnaround area.

**Table 8-7. Forward Operating Base (FOB) STOVL Runway Criteria**

Table 8-7. Forward Operating Base (FOB) STOVL Facility Runway Criteria			
Item		Requirement	Remarks
No.	Description		
1	Length	914 m (3,000 ft)	
2	Width	Min. 10m (32ft)	Typical width is 18.5m (60 ft).
3	Width of shoulders	Min. 3 m (10 ft)	Navy and Marine Corps airfields
4	Paved shoulder width	3 m (10 ft)	Navy and Marine Corps airfields
5	Paved Overrun length	Min 91.44 m (300 ft)	The length of the overrun may be dependent on the approach path length where the aircraft will be below 25 ft AGL.
6	Paved Overrun width	Min.15.85m (52 ft)	The width of the Overrun will match the total width of the runway plus shoulders. Typical width is 24.5m (80 ft).
7	Graded Clear Zone Length	Min. 60.96 m (500 ft)	Measured from the runway threshold. Corresponds to the Clear Zone Area.
8	Graded Clear Zone Width	Min. 91.44 m (300 ft)	Centered on the runway centerline. Corresponds to the Clear Zone area.
9	Longitudinal grades of runway and shoulders	Max 3.0%	Grades may be both positive and negative but must not exceed the limit specified. - Grade restrictions are exclusive of other pavements and shoulders. - Where other pavements tie into runways, comply with grading requirements for towways, taxiways, or aprons as applicable, but hold grade changes to the minimum practicable to facilitate drainage.
10	Longitudinal runway grade change	Max 1.5% per 61m (200 ft)	Where economically feasible, the runway will have a constant centerline gradient from end to end.



Table 8-7. Forward Operating Base (FOB) STOVL Facility Runway Criteria			
Item		Requirement	Remarks
No.	Description		
11	Longitudinal Overrun grade	Max 3.0%	Grades may be both positive and negative but must not exceed the limit specified. Grade restrictions are exclusive of other pavements and shoulders. - Where other pavements tie into runways, comply with grading requirements for towways, taxiways, or aprons as applicable, but hold grade changes to the minimum practicable to facilitate drainage.
12	Graded Clear Zone slope	Max. 10.0%	Does not apply to overrun paved surfaces. Grades may be both positive and negative but must not exceed the limit specified. Applies to both longitudinal and transverse directions.
13	Transverse grade of runway	Min 0.5% Max 3.0%	- New STOVL training facility pavements will be centerline crowned to insure adequate drainage of surface water. - Existing STOVL facility and runway pavements with insufficient transverse gradients for rapid drainage should provide increasing gradients when overlaid or reconstructed.
14	Transverse grade of paved shoulder	Min 1.5% Max 5.0%	Paved portion of shoulder Slope downward from runway pavement. Reversals are not allowed.
15	Transverse grade of Overrun	Min 0.5% Max 3.0%	Slope pavement downwards from the runway with no reversals to insure adequate drainage of surface water. Exception is at or adjacent to intersections where the pavement surfaces must be warped to match abutting pavements.
16	Runway Lateral Clearance Zone (corresponds to half the width of primary surface)	45.72 m (150 ft)	Supports VFR operations - Measured perpendicularly from centerline of STOVL facility. This area is to be clear of fixed and mobile obstacles. - In addition to the lateral clearance criterion, the vertical height restriction on structures and parked aircraft as a result of the transitional slope must be taken into account. - Fixed obstacles include man-made or natural features constituting possible hazards to moving aircraft.
17	Transverse grades within Runway Lateral Clearance Zone	Max 10.0%	- Exclusive of pavement, shoulders, and cover over drainage structures. - Slopes are to be as gradual as practicable. Avoid abrupt changes or sudden reversals. Rough grade to the extent necessary to minimize damage to aircraft.
18	Distance from centerline of fixed-wing runway to the centerline of a parallel	Min 213.36m (700 ft)	Simultaneous VFR operations for Class A runway
		Min 304.80 m (1,000 ft)	Simultaneous VFR operations for Class B runway.

Table 8-7. Forward Operating Base (FOB) STOVL Facility Runway Criteria			
Item		Requirement	Remarks
No.	Description		
	FOB runway	Min 213.36m (700 ft)	Non- simultaneous VFR operations. Distance may be reduced to 60.96m (200ft); however, waiver must be based on wake-turbulence and jet blast. FOB may be sited within the adjacent runway primary surface but must be positioned outside the adjacent runway hold position markings.

CANCELLED

**Table 8-8. Forward Operating Base (FOB) STOVL Airspace Imaginary Surfaces**

Table 8-8. FOB STOVL Airspace Imaginary Surfaces				
Item		Legend	Requirement	Remarks
No.	Description			
1	Primary surface width	A	91.44 m (300 ft)	Centered on FOB runway.
2	Primary surface length	A	Runway length + 60.96 m (200 ft) at each end	Primary surface extends 60.96 m (200 ft) beyond each end of the FOB runway
3	Primary surface elevation	A	See Remarks	The elevation of the primary surface is the same as the elevation of the nearest point on the FOB runway centerline
4	Clear Zone longitudinal and transverse grade of surface	B	Max 10.0%	See Table 8-4, Safety Zone Grades
5	Start of approach-departure Surface	C	60.96 m (200 ft)	Measured from the end of the FOB runway.
6	Length of sloped portion of approach-departure surface	C	Min 5334 m (17,500 ft)	Measured horizontally
7	Slope of approach-departure surface	C	35:1	Slope ratio is horizontal: vertical.  Example: 35:1 is 35 m (ft) horizontal to 1 m (ft) vertical.
8	Width of approach-departure surface at start of sloped portion	C	91.44 m (300 ft)	Centered on the extended FOB runway centerline and is the same width as the primary surface.
9	Width of approach-departure surface at end of sloped portion	C	891.5 m (2,925 ft)	- Centered on the extended FOB runway centerline. - The 1000:75 width ratio is horizontal length: horizontal width. This ratio is consistent with class-A VFR runway requirements. - At US Navy and Marine Corps VTSOL facilities where the lateral clearance was established according to previous criterion, that distance may remain.
10	Elevation of approach-departure surface at start of sloped portion	C	0 m (0 ft)	Same as the FOB runway centerline at the threshold.

Table 8-8. FOB STOVL Airspace Imaginary Surfaces

Item		Legend	Requirement	Remarks
No.	Description			
11	Elevation of approach-departure surface at end of sloped portion	C	152.4 m (500 ft)	Above the established FOB runway elevation.
12	Start of horizontal portion of approach-departure surface	D	Min 5334 m (17,500 ft)	Measured from the end of the primary surface. The end of the primary surface (start of the approach-departure surface) is 60.96 m (200 ft) from the end of the FOB runway.
13	Length of horizontal portion of approach-departure surface	D	Min 4419 m (14,500 ft)	Measured horizontally along the ground.  Total approach path length is the same total length as the LZ approach path 9,753 m (32,000 ft).
14	Width of approach-departure surface at start of horizontal portion	D	891.5 m (2,925 ft)	Centered along the FOB runway extended centerline.
15	Width of app-dep surface at end of horizontal portion	D	1,555 m (5,100 ft)	- Centered along the FOB runway extended centerline. - The 1000:75 width ratio is horizontal length: horizontal width. This ratio is consistent with class-A VFR runway requirements.
16	Elevation of horizontal portion of approach-departure surface	D	152.4 m (500 ft)	Above the established FOB runway elevation
17	Radius of inner horizontal surface	E	1,600 m (5,250 ft)	Imaginary surface constructed by scribing an arc with a radius of 1,600m (5,250 ft) about the centerline at each end of the FOB runway and interconnecting these arcs with tangents.
18	Width between outer edges of inner horizontal surface	E	3,200 m (10,500 ft)	
19	Elevation of inner horizontal surface	E	45.72 m (150 ft)	Above the established FOB runway elevation. Exception: When the FOB is adjacent to an airfield, the inner horizontal surface is established to match the adjacent airfield's inner horizontal surface.
20	Horizontal width of conical surface	F	NA	Conical surface not required
21	Slope of conical surface	F	NA	Conical surface not required

Table 8-8. FOB STOVL Airspace Imaginary Surfaces

Item		Legend	Requirement	Remarks
No.	Description			
22	Elevation of conical surface at start of slope	F	NA	Conical surface not required
23	Elevation of conical surface at the end of slope	F	NA	Conical surface not required
24	Distance to outer edge of conical surface	G	NA	Outer horizontal surface not required
25	Width of outer horizontal surface	G	NA	Outer horizontal surface not required
26	Elevation of outer horizontal surface	G	NA	Outer horizontal surface not required
27	Distance to outer edge of outer horizontal surface	G	NA	Outer horizontal surface not required
28	Start of transitional surface	H	45.72 m (150 ft)	Measured perpendicularly from FOB runway centerline.
29	End of transitional surface	H	Various	The transitional surface ends at the inner horizontal surface, conical surface, or at an elevation of 45.72 m (150 ft). See NOTE 1.
30	Slope of transitional surfaces	H	2:1	<ul style="list-style-type: none"> <li>- Slope ratio is horizontal: vertical. 2:1 is 2 m (ft) horizontal to 1 m (ft) vertical.</li> <li>- Vertical height of vegetation and other fixed or mobile obstacles and/or structures will not penetrate the transitional surface. Taxiing aircraft are exempt from this requirement.</li> <li>- For Navy and Marine Corps airfields, taxiway pavements are exempt from this requirement.</li> <li>- For the USAF, the air traffic control tower is exempt from this requirement if the height will not affect TERPS criteria.</li> </ul>

**NOTES:**

1. When the FOB STOVL facility is located within the boundaries of an existing DoD airfield and the imaginary surfaces of the two facilities overlap, the FOB STOVL facility transitional surface elevation will extend to meet the existing inner horizontal surface elevation of the DoD airfield. The FOB STOVL facility imaginary surface requirements may be waived provided the existing DoD airfield imaginary surfaces meet or exceed the obstacle clearance requirements defined by the imaginary surfaces in Table 8-8.
2. When the FOB STOVL facility is located parallel with an existing DoD runway use of the runway approach/departure surface may suffice for the FOB STOVL facility approach/departure surface provided a visual transition between the path and the FOB STOVL facility can be conducted while under VMC conditions.

**Table 8-9. Forward Operating Base (FOB) STOVL Facility Clear Zone and APZs**

Item		Legend	Requirement	Remarks
No.	Description			
1	Clear Zone	B	Length: 152.40m (500 ft)  Width: 91.44m (300 ft)	Length measured along the extended runway centerline beginning at the end of the runway.  Width measured perpendicular to the extended runway centerline.
2	APZ I	J	Length: 762.00m (2,500 ft)  Width: 152.40m (500 ft)	APZ I starts at the end of the clear zone, and is centered and measured on the extended runway centerline.  Modification (reduction) from class-A runway requirement is made because all STOVL facility operations will be VMC, and all landings and departures will be under the supervision of a Landing Site Supervisor (LSS).
3	APZ II	J	Length: 762.00m (2,500 ft)  Width: 304.80m (1,000 ft)	APZ II starts at the end of the APZ I and is centered and measured on the extended runway centerline.  Class A runway criteria are used because all STOVL facility operations will under VMC, and all landings and departures will be under the supervision of a Landing Site Supervisor (LSS).

**Figure 8-31. Forward Operating Base STOVL Facility Outline**

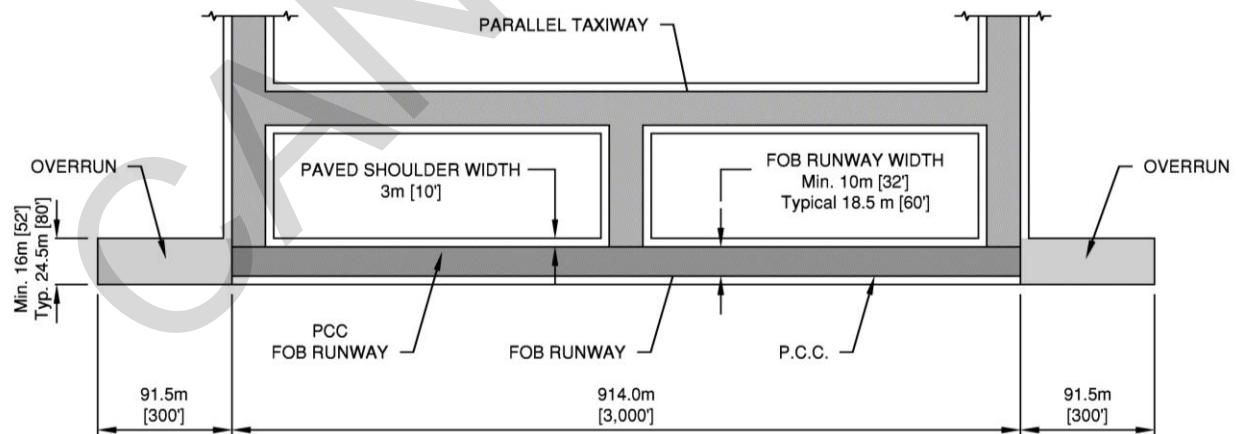

Figure 8-32. Forward Operating Base STOVL Facility with Clearance Zones

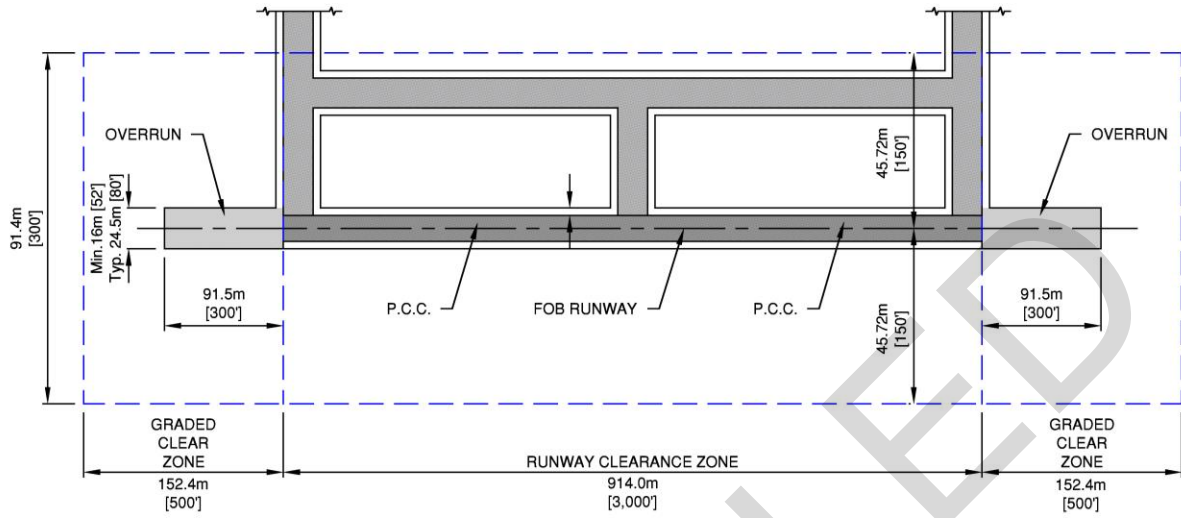
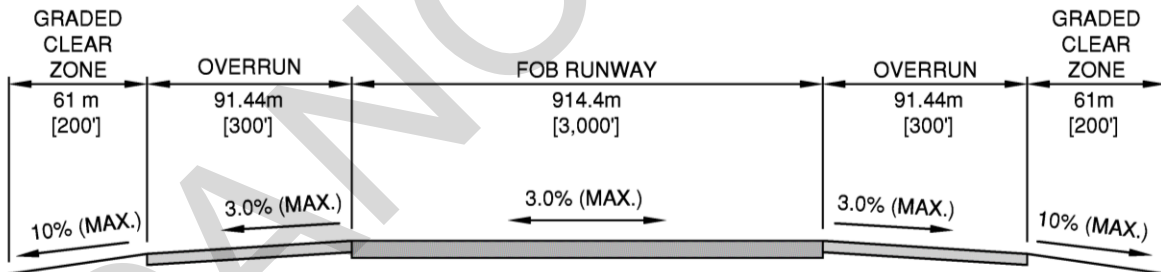

Figure 8-33. Forward Operating Base STOVL Facility Longitudinal Gradient



FOB STOVL LONGITUDINAL SECTION

N.T.S.

Figure 8-34. Forward Operating Base STOVL Facility Transverse Section

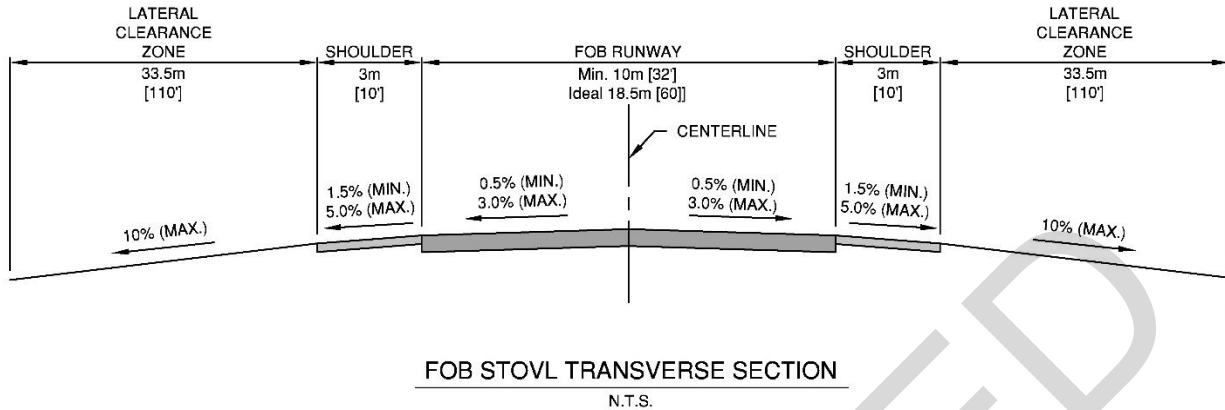

Figure 8-35. Forward Operating Base STOVL Facility Departure Clearance Surface and Clear Zone

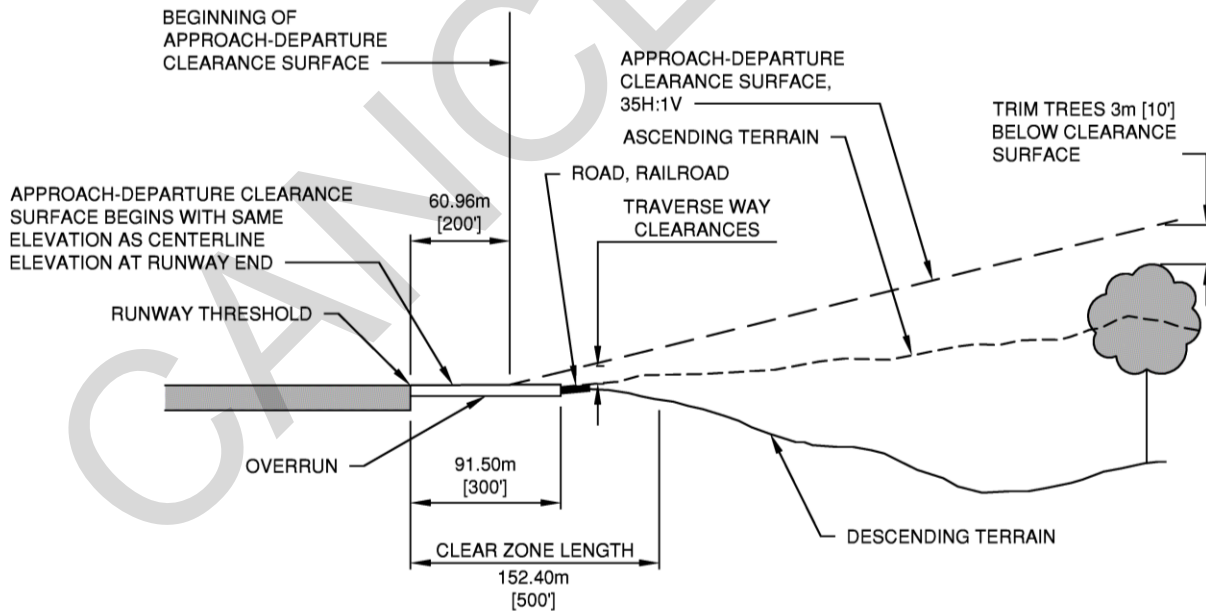



Figure 8-36. Forward Operating Base STOVL Facility Departure Clear Zones and APZs

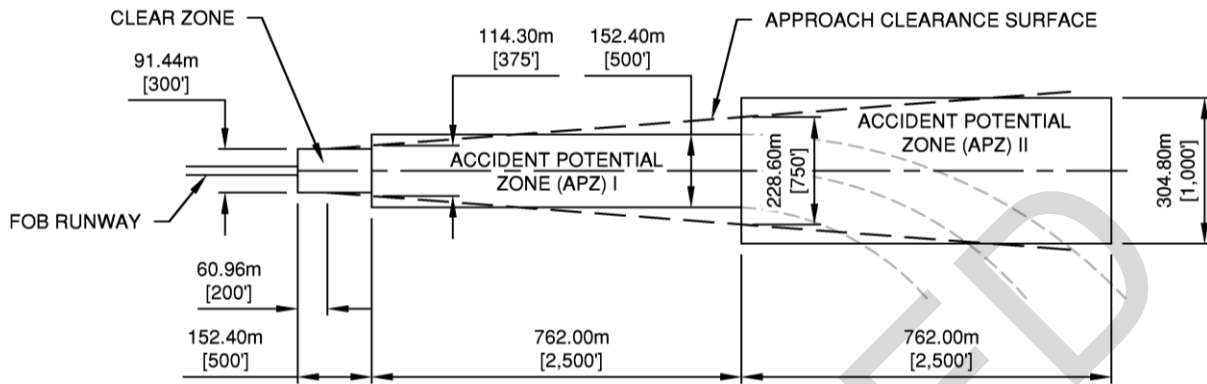
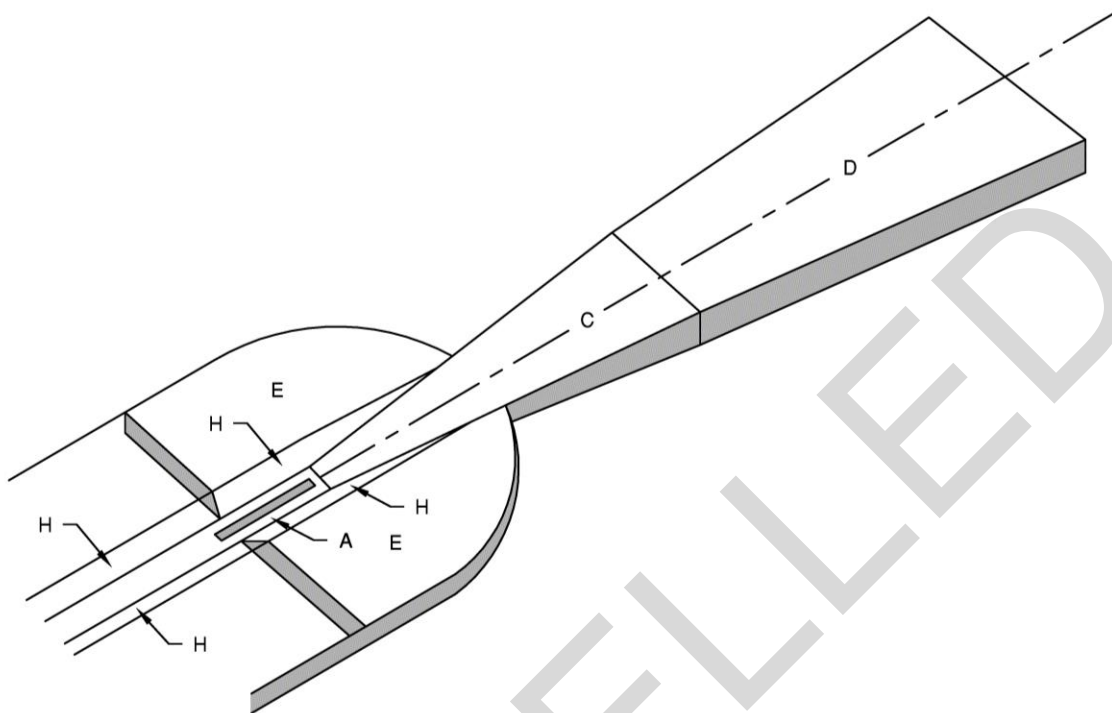

Figure 8-37. Forward Operating Base STOVL Facility Isometric



LEGEND

- A PRIMARY SURFACE
- B CLEAR ZONE SURFACE (NOT SHOWN)
- C APPROACH-DEPARTURE CLEARANCE SURFACE (35:1 SLOPE RATIO)
- D APPROACH-DEPARTURE CLEARANCE SURFACE (HORIZONTAL, 152.40m [500'] ELEVATION)
- E INNER HORIZONTAL SURFACE (45.72m [150'] ELEVATION)
- F NOT USED
- G NOT USED
- H TRANSITIONAL SURFACE (2:1 SLOPE RATIO)
- I NOT USED
- J ACCIDENT POTENTIAL ZONE (APZ) (NOT SHOWN)

ISOMETRIC

N.T.S.

Figure 8-38. Forward Operating Base STOVL Facility Imaginary Surfaces

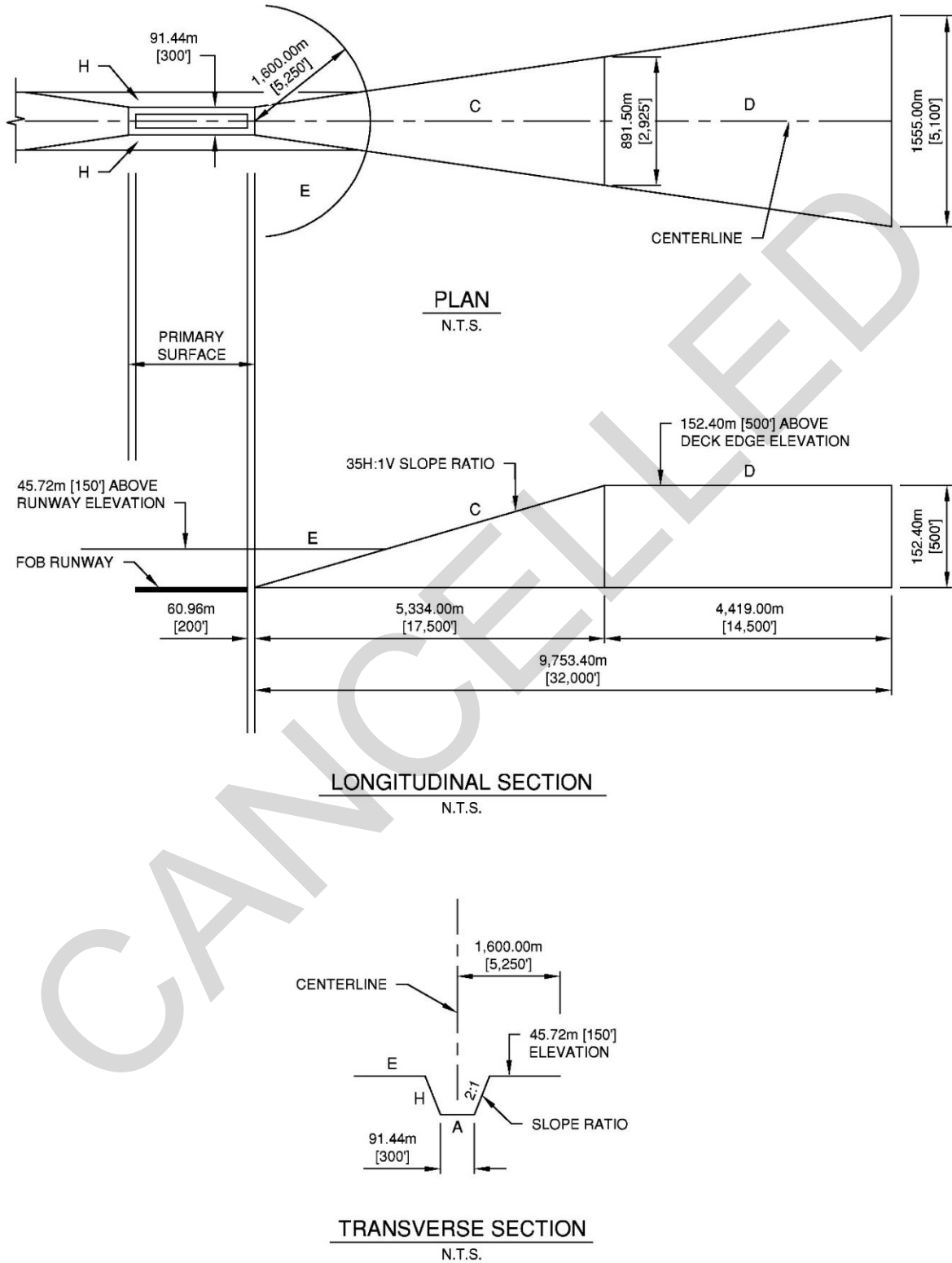

Figure 8-39. Forward Operating Base STOVL Facility Runway End Detail

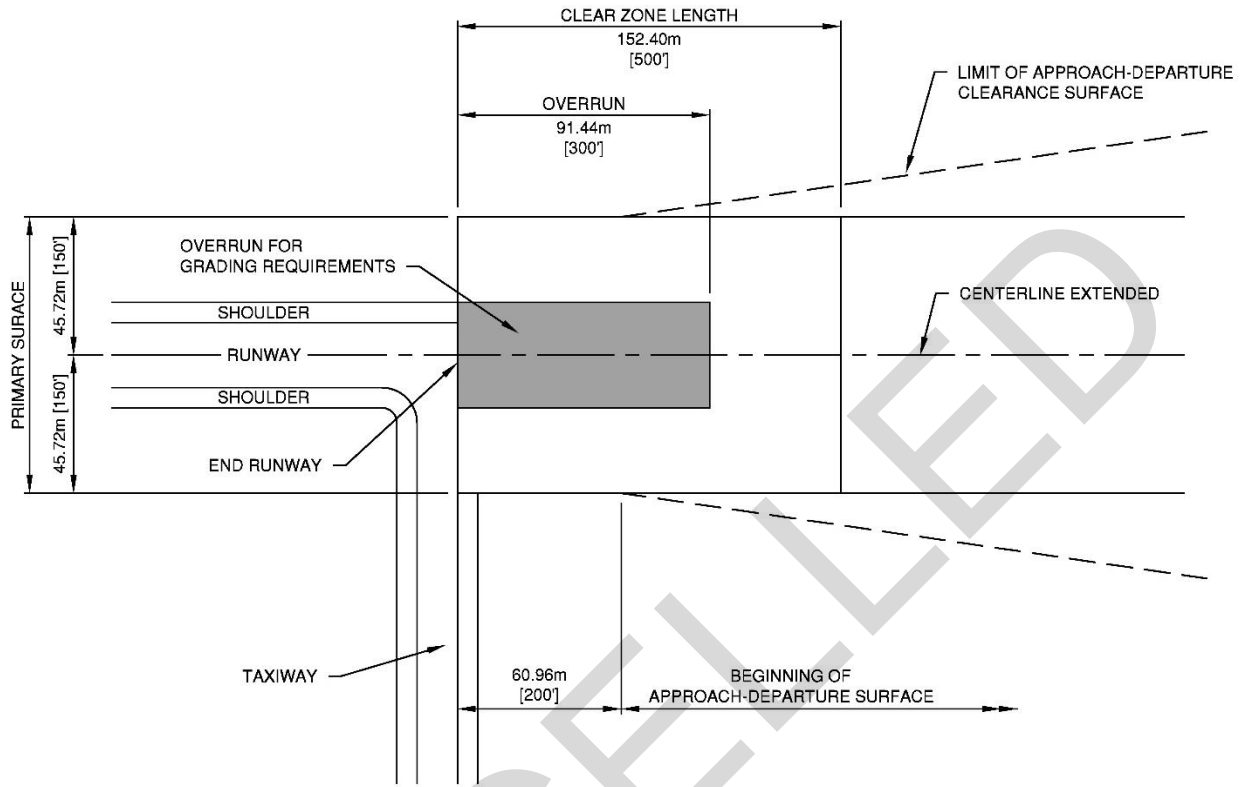

Figure 8-40. Forward Operating Base STOVL Facility Markings

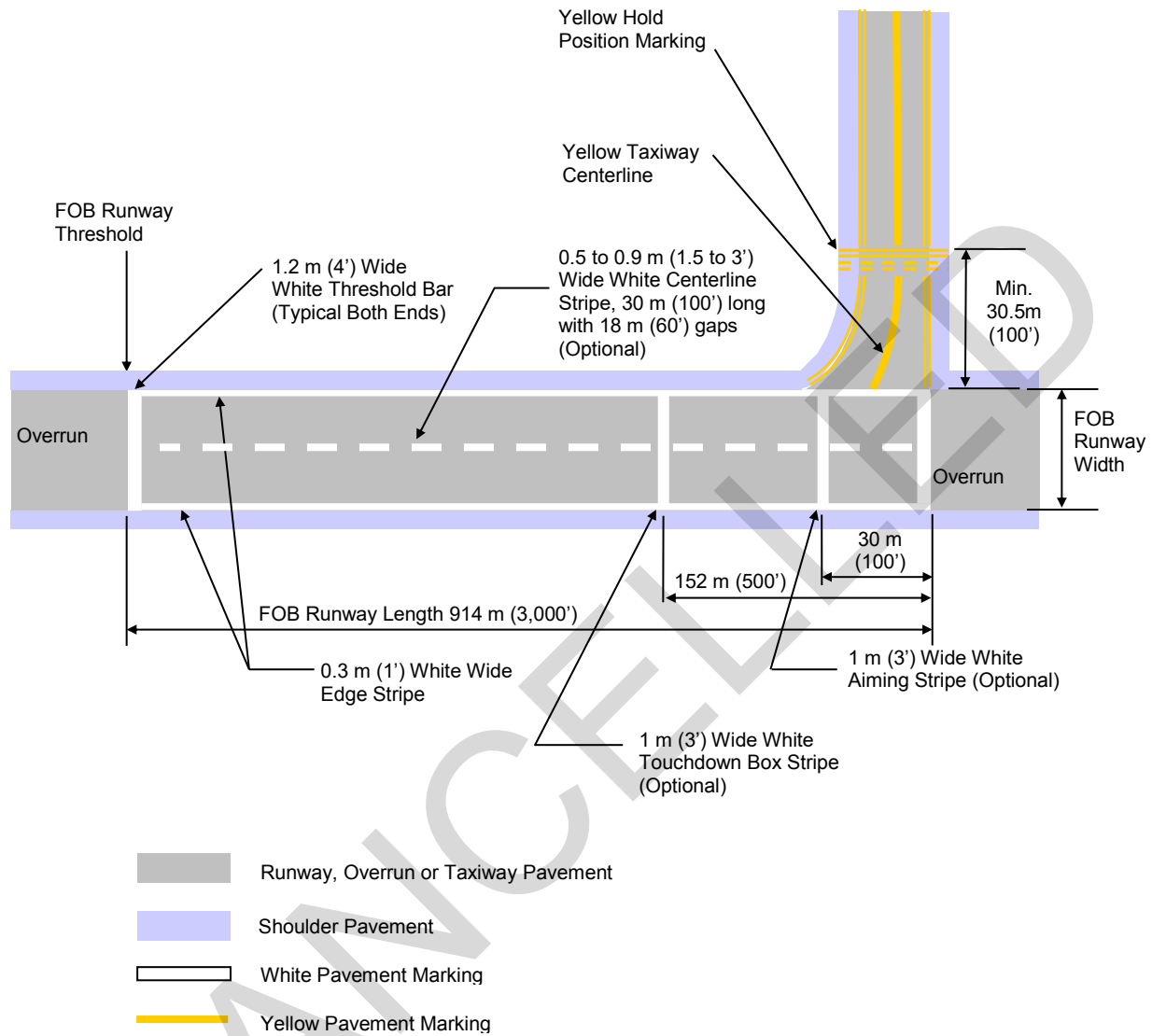

Figure 8-41. Forward Operating Base STOVL Facility Lighting

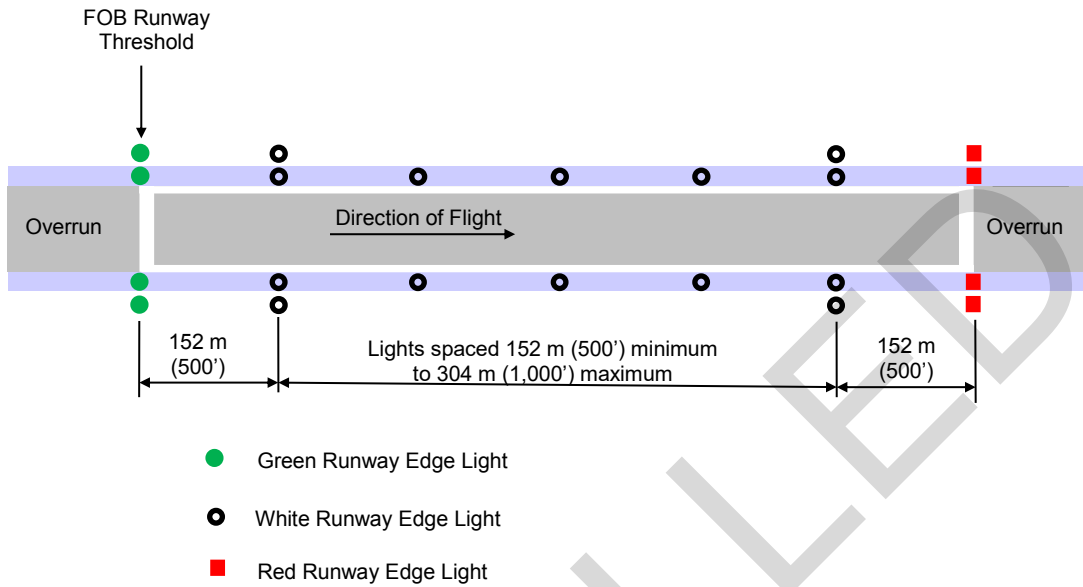
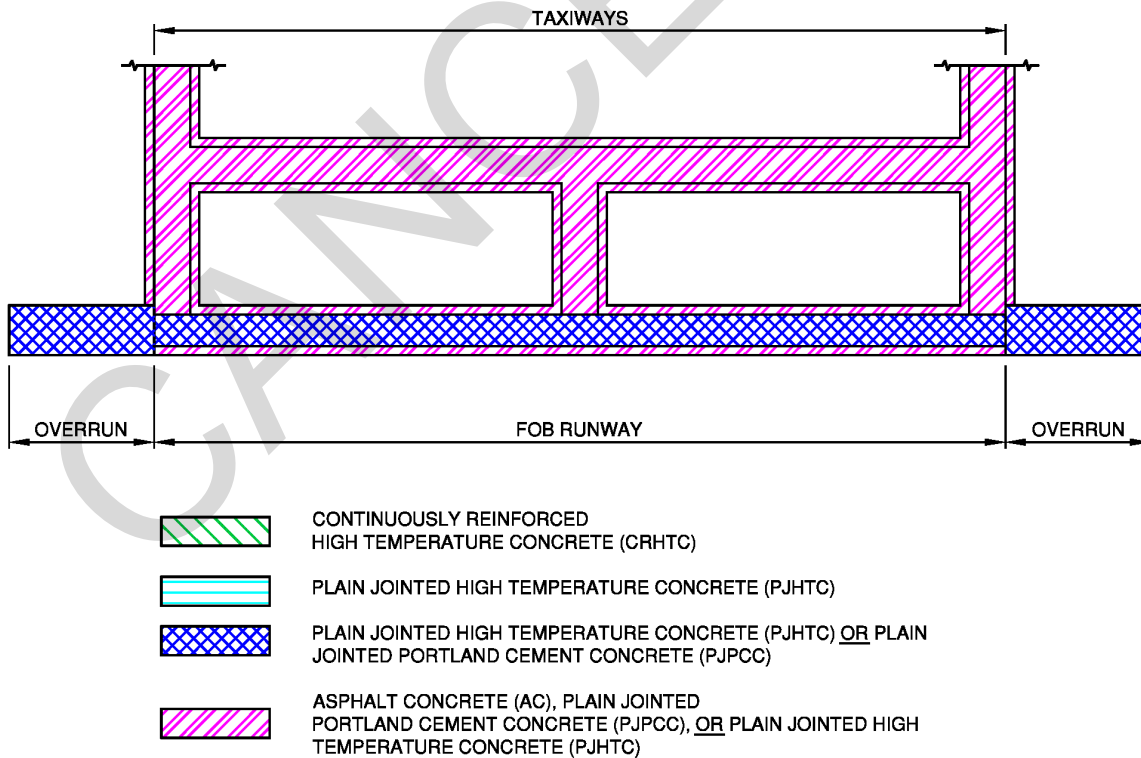

Figure 8-42. STOVL FOB Pavement Surface Types



## **8-7 V-22 TILT-ROTOR OUTLYING LANDING FIELD (OLF) FACILITY FOR TRAINING.**

### **8-7.1 OLF Concept.**

OLFs are auxiliary airfields generally located near and associated with a Naval or Marine Corps Air Station. OLF's have no based units or aircraft and only minimal facilities. They are usually positioned in an area with low aircraft traffic to provide proficiency training and flexibility for degraded aircraft system recovery.

### **8-7.2 OLF Standard Drawings.**

No standard drawings have been developed for OLF facilities. The criteria provided in this chapter must be site-adapted to the proposed location.

### **8-7.3 OLF Background.**

OLF training varies slightly from location to location; however, in general terms the facility would be narrower and shorter than a standard Class A or B runway. OLFs are auxiliary airfields, generally located near and associated with a Naval or Marine Corps Air Station. In most cases, OLF's have no based units or aircraft and only minimal facilities. They are usually positioned in an area with low aircraft traffic for flight training, with reduced risks and distractions of other aircraft traffic.

#### **8-7.3.1 Assumptions.**

- Airspace imaginary surfaces are defined for a standalone training facility.
- The imaginary surfaces for the OLF facility provide obstacle clearance for the V-22 visual landing pattern. The OLF visual landing pattern altitude defines the inner horizontal surface and transitional area elevations. An overhead entry or straight-in visual approach will be the entry maneuver for the OLF visual pattern, and the obstacle clearance needed for these maneuvers define the approach and departure surface requirements. These definitions are presented similar to the existing Class B runway criteria.
- A 300 m (1,000-ft) primary surface width is used for the OLF facility.

### **8-7.4 OLF Geometry.**

#### **8-7.4.1 OLF Runway, Overrun, and Safety Zone Descriptions.**

Figures 8-43 through 8-46 and Table 8-10 provide dimensional criteria for the layout and design of the OLF runway, overruns, and safety zones. The OLF runway should be considered bi-directional unless specifically limited to a single approach and departure path. Overruns and shoulders are provided as safety zones to prevent erosion of graded surfaces by jet blast from aircraft and surface water runoff, and to provide a smooth transition from paved to unpaved surface. Runway shoulders are not required in

cases where the runway width meets or exceeds the combined total widths for the runway and shoulders defined in this document. Each zone or surface contains a brief description of their use and reference to where their specific dimension or graphic is located within the document.

#### **8-7.4.2 Runway Length.**

Table 8-10 provides the minimum length for the OLF runway. Training and operational facilities will be of various lengths based on facilities available, elevation, and supported mission.

#### **8-7.4.3 Runway Width.**

Table 8-10 provides the minimum width for the OLF runway. Training and operational facilities will be of various widths based on facilities available and supported mission.

#### **8-7.4.4 Gradients of Operational Surfaces.**

Gradient constraints are based upon sufficient slope to insure surface water runoff. A uniform transverse slope is preferable to eliminate irregularities between landing gear at touchdown. For this reason, the OLF runway should be centerline crowned or the entire runway sloped in one direction. Either sloping scheme will provide the pilot with a consistent uniform surface adequate for touchdown. See Table 8-10 and Figures 8-45 and 8-46.

#### **8-7.4.5 Overrun Length.**

Table 8-10 provides the length of the overrun for both the approach and departure ends.

#### **8-7.4.6 Overrun Width.**

Table 8-10 provides the width of the overrun. This width, at a minimum, reflects the width of the OLF runway plus any shoulder width and will be centered on the extended runway centerline.

#### **8-7.4.7 Shoulder Length.**

Table 8-10 provides the length of the shoulder. This length is dependent on the length of the OLF runway and ties into the overrun on both ends of the OLF runway for one continuous surface.

#### **8-7.4.8 Shoulder Width.**

Table 8-10 provides the width of the shoulder. This width is designed to prevent soil erosion from jet blast or surface water runoff and provide a smooth transition to the graded unpaved shoulder areas.

#### **8-7.5 OLF Separation Distances.**



Table 8-10 provides the minimum separation distances between permanent runways/helipads and the OLF runway for simultaneous operations. Table 8-10 provides the minimum separation distances between permanent Class A or Class B Runways and OLF runway for non-simultaneous operations.

### **8-7.6 OLF Clear Zones, Imaginary Surfaces, and APZs.**

Figures 8-47 through 8-50 and Tables 8-11 and 8-12 provide applicable clearances and grade controls for a reasonable level of safety. Their description and layout are similar to other airfield types and are not unique to the OLF runway or facility. Each zone or surface contains a brief description of their use and reference to where their specific dimension or graphic is located within the document.

#### **8-7.6.1 Clear Zones.**

Runway clear zones are areas on the ground, located at the ends of each runway. The OLF runway should be considered bi-directional unless specifically limited to a single approach and departure path. They possess a high potential for accidents, and their use is restricted to be compatible with aircraft operations. Runway clear zones are required for the runway and should be owned or protected under a long-term lease and must be cleared and graded. See Table 8-12.

#### **8-7.6.2 Imaginary Surfaces.**

Surfaces in space established around a STOV L facility in relation to the OLF runway and designed to define the protected airspace around the STOV L facility. The imaginary surfaces for the OLF facilities are the primary surface, transitional surface, inner horizontal surface and approach-departure path surfaces. See Table 8-11.

#### **8-7.6.3 Accident Potential Zones.**

A land use control area beyond the clear zone of a STOV L facility that possesses a significant potential for accidents, and their use is restricted in accordance with DoDI 4165.57. Their dimensions and layout are listed in Table 8-12. Navy planners will use OPNAVINST 11010.36C/MCO 11010.16 (or latest version) to determine specific AICUZ requirements. For the Air Force, land use guidelines within the clear zone (beyond the graded area) and APZ I and APZ II are provided in AFI 32-7063 and AFH 32-7084.

#### **8-7.7 OLF Pavement Markings.**

No pavement markings are required for OLF facilities.

#### **8-7.8 OLF Lighting.**

No airfield lighting is required for OLF facilities.

#### **8-7.9 OLF Pavement Surface Types.**

Figure 8-51 shows the pavement types needed for Tilt-Rotor OLF. The paved operations surfaces used for these facilities will be constructed with HMA or PJPCC. Life-cycle cost considerations should be used to determine whether PJHTC is cost effective to improve the durability of the pavement and reduce future pavement demands, particularly for the first and last 150 m (500 ft). Seal joints in rigid pavement with neoprene.

**Table 8-10. Tilt-Rotor Outlying Landing Field (OLF) Facility Criteria**

Table 8-10. Tilt-Rotor Outlying Landing Field (OLF) Facility Criteria			
Item		Requirement	Remarks
No.	Description		
1	Runway Length	Min. 490 m (1,600 ft)	Basic length to be corrected for elevation and temperature. Increase 10% for each 300 m (1,000 ft) in elevation above 600 m (2,000 ft) MSL and add 4.0% for each 5 degree Celsius (10 degree Fahrenheit), above 15 degree Celsius (59 degree Fahrenheit) for the average daily maximum temperature for the hottest month.  (1) Additional runway length will be provided based on operational and training requirements. Justification will be provided on a case-by-case basis.  (2) For special mission or proficiency training such as autorotation operations, the length may be increased up to 300 m (1,000 ft) with no additive corrections.
2	Runway Width	Min. 30m (100ft)	
3	Total Width of shoulders (paved and unpaved) adjacent to all operational pavements	Min. 7.5 m (25 ft)	Minimum of 3.75m (12.5 ft) of shoulder width will be paved o provide a minimum width of 37.5 m (125 ft) of paved surface (30 m + 3.75m + 3.75 m (100 ft + 12.5 ft + 12.5 ft)).
4	Paved shoulder width	3.75 m (12.5 ft)	
5	Overrun length (unpaved)	Min 120 m (400 ft)	
6	Overrun width	Min. 37.5 m (125 ft)	The width of the Overrun will match the total width of the runway plus paved shoulders.
7	Longitudinal grades of OLF Runways, Overruns and Shoulders	Max 1.0%	Grades may be both positive and negative but must not exceed the limit specified. - Grade restrictions are exclusive of other pavements and shoulders. - Where other pavements tie into runways, comply with grading requirements for towways, taxiways, or aprons as applicable, but hold grade changes to the minimum practicable to facilitate drainage.
8	Longitudinal grade change on OLF Runways, Overruns and Shoulders	Max 0.167% per 30m (100 ft)	Where economically feasible, the runway will have a constant centerline gradient from end to end. Exceptions: 0.4% per 30 m (100 ft) for edge of runways at runway intersections.

Table 8-10. Tilt-Rotor Outlying Landing Field (OLF) Facility Criteria			
Item		Requirement	Remarks
No.	Description		
9	Transverse grade of runway	Min 1.0% Max 1.5%	OLF Runway may be centerline crowned or single cross-slope to insure adequate drainage of surface water.
10	Transverse grade of paved shoulder	Min 2.0% Max 4.0%	Slope downward from runway pavement. Reversals are not allowed.
11	Transverse grade of unpaved shoulder (adjacent to paved shoulder)	(a) 40 mm (1.5 inches) drop off at edge of paved shoulder  (b) 5% slope first 3 m (10 ft)  (c) Primary Surface criteria apply beyond this point	Slope downward from edge of shoulder.   See Item 14.
12	Transverse grade of Overrun	Min 2.0% Max 3.0%	Slope pavement downwards from the runway with no reversals to insure adequate drainage of surface water. Exception is at or adjacent to intersections where the pavement surfaces must be warped to match abutting pavements.
13	Runway Lateral Clearance Zone (corresponds to half the width of primary surface)	150 m (500 ft)	Measured perpendicularly from centerline of OLF runway. This area is to be clear of fixed and mobile obstacles. In addition to the lateral clearance criterion, the vertical height restriction on structures and parked aircraft as a result of the transitional slope must be taken into account. (1) Fixed obstacles include man-made or natural features constituting possible hazards to moving aircraft. See Note 1. (2) Mobile obstacles include parked aircraft, parked and moving vehicles, railroad cars and similar equipment. (3) Taxiing aircraft are exempt from this restriction. However, parallel taxiways (exclusive of shoulder width) must be located in excess of the lateral clearance distance.
14	Grades within the Primary Surface (in any direction)	Max 5.0%	- Exclusive of pavement, shoulders, and cover over drainage structures. - Slopes are to be as gradual as practicable. Avoid abrupt changes or sudden reversals. Rough grade to the extent necessary to minimize damage to aircraft.

Table 8-11. Tilt-Rotor Outlying Landing Field (OLF) Airspace Imaginary Surfaces

Table 8-11. Tilt-Rotor OLF Airspace Imaginary Surfaces

Item		Legend	Requirement	Remarks
No.	Description			
1	Primary surface width	A	300 m (1,000 ft)	Centered on OLF runway centerline.
2	Primary surface length	A	Runway length + 61 m (200 ft) at each end	Primary surface extends 61 m (200 ft) beyond each end of the OLF runway
3	Primary surface elevation	A	See Remarks	The elevation of the primary surface is the same as the elevation of the nearest point on the OLF runway centerline
4	Grade of Clear Zone in any direction	B	5.0% Max.	The clear zone starts at the end of the primary surface and has the same width as the primary surface (93.5 m [300 ft]), with a length of 400 ft. - Clear zones are areas on the ground, located at the ends of the primary surface, centered on the primary approach path to the VL pad. - Areas to be free of obstructions. Rough grade and turf when required. Positive drainage to avoid standing water.
5	Start of OLF Approach-Departure Surface	C	61 m (200 ft)	Measured from the end of the OLF runway.
6	Length of sloped portion of OLF Approach-Departure Surface	C	Min 2,400 m (8,000 ft)	Measured horizontally
7	Slope of OLF Approach-Departure Surface	C	20:1	Slope ratio is horizontal: vertical. Example: 20:1 is 20 m (ft) horizontal to 1 m (ft) vertical. For clearances over highway and railroads, see Table 3-8, Imaginary Surfaces Minimum Clearances over Highway, Railroad, Waterway and Trees.
8	Width of OLF Approach-Departure Surface at start of sloped portion	C	300 m (1,000 ft)	Centered on the extended OLF runway centerline, and is the same width as the primary surface.
9	Width of OLF Approach-Departure Surface at end of sloped portion	C	1,030 m (3,400 ft)	Centered on the extended OLF runway centerline.

Table 8-11. Tilt-Rotor OLF Airspace Imaginary Surfaces

Item		Legend	Requirement	Remarks
No.	Description			
10	Elevation of Approach-Departure Surface at start of sloped portion	C	0 m (0 ft)	Same as the OLF runway centerline at the threshold.
11	Elevation of OLF Approach-Departure Surface at end of sloped portion	C	120 m (400 ft)	Above the established OLF runway elevation.
12	Transitional Surface Slope	—	2:1	Slope ratio is horizontal:vertical. 2:1 is 2 m (ft) horizontal to 1 m (ft) vertical.  (1) The transitional surface starts at the lateral edges of the Primary Surface and the Approach-Departure Surface. It continues outward and upward at the prescribed slope to an elevation of 45 m (150 ft) above the established airfield elevation.
13	Inner Horizontal Surface Radius	E	1,400 m (4,600 ft)	An Imaginary surface constructed by scribing an arc with a radius of 1,400 m (4,600 ft) about the centerline at each end of the OLF runway and interconnecting these arcs with tangents.
14	Elevation of Inner Horizontal Surface	E	45 m (150 ft)	Above the established OLF runway elevation. Exception: When the OLF is adjacent to an airfield, the inner horizontal surface is established to match the adjacent airfield's inner horizontal surface.

**Table 8-12. Tilt-Rotor Outlying Landing Field (OLF) Clear Zone and APZs**

Item		Legend	Requirement	Remarks
No.	Description			
1	Clear Zone	B	Length: 120 m (400 ft)  Width: 300 m (1,000 ft)	Length measured along the extended runway centerline beginning at the end of the primary surface.  Width of Clear Zone is centered on and measured perpendicular to the extended runway centerline.
2	Clear Zone Grades (any direction)		Min 2.0% Max. 5.0%	Clear Zone only. Area to be free of obstructions. Rough grade and turf when required.
3	APZ I	J	Length: 240 m (800 ft)  Width: 300m (1,000 ft)	APZ I starts at the end of the clear zone, and is centered and measured on the extended runway centerline.

CANCELLED

Figure 8-43. Tilt-Rotor Outlying Landing Field (OLF) Facility Outline

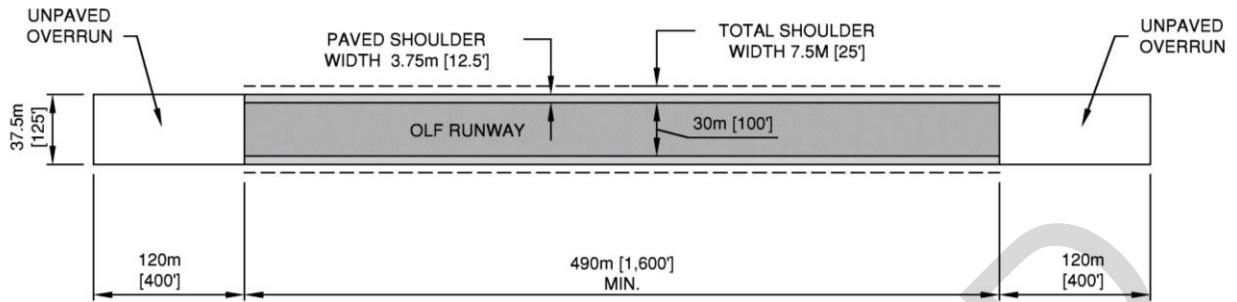

Figure 8-44. OLF Facility with Clear Zones

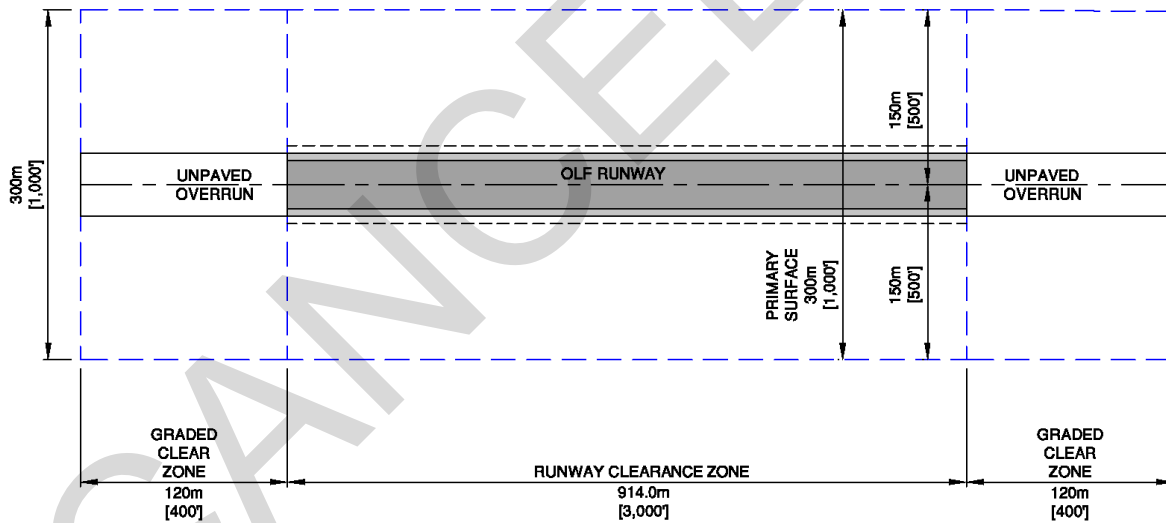
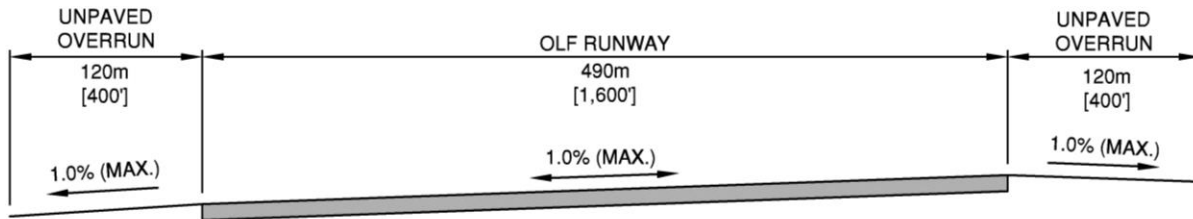

Figure 8-45. OLF Facility Longitudinal Gradient



OLF RUNWAY LONGITUDINAL SECTION

N.T.S.

Figure 8-46. OLF Facility Transverse Section

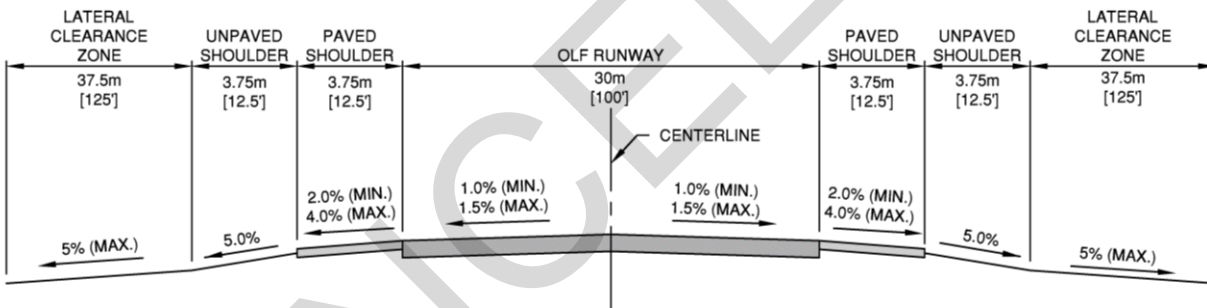

OLF RUNWAY TRANSVERSE SECTION

N.T.S.

**NOTES**

1. 40mm [1.5 inch] DROPOFF AT EDGE OF PAVED SHOULDER.



Figure 8-47. OLF Facility Approach-Departure Clearance Surface and Clear Zone

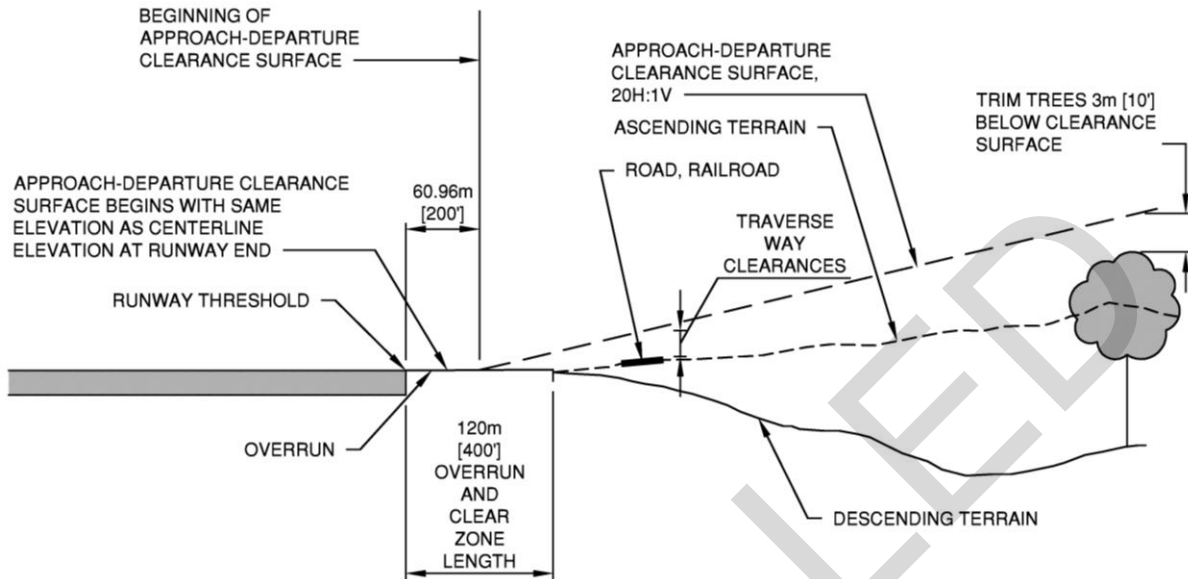

Figure 8-48. OLF Facility Clear Zones and APZs

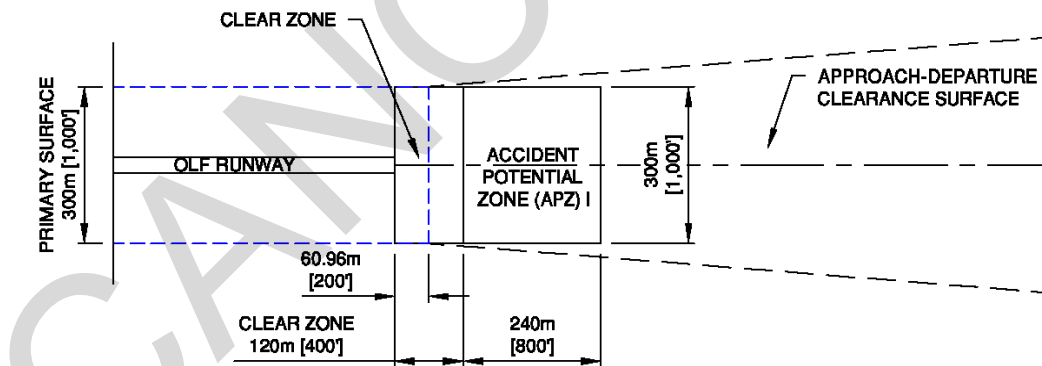
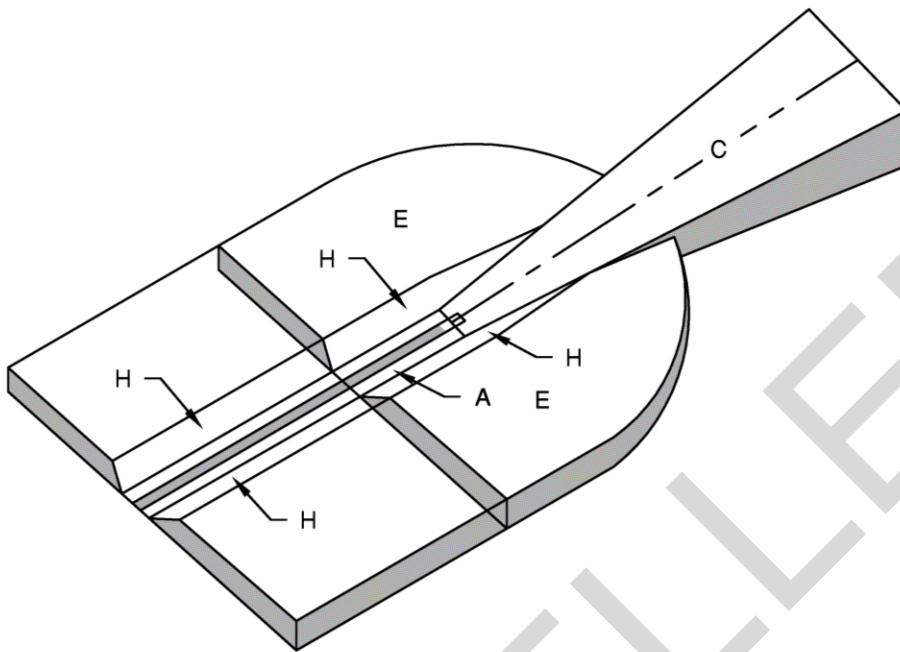

Figure 8-49. OLF Facility Isometric



LEGEND

- A PRIMARY SURFACE
- B CLEAR ZONE SURFACE (NOT SHOWN)
- C APPROACH-DEPARTURE CLEARANCE SURFACE (20:1 SLOPE RATIO)
- D APPROACH-DEPARTURE CLEARANCE SURFACE (HORIZONTAL, 152.40m [500'] ELEVATION)
- E INNER HORIZONTAL SURFACE (45.72m [150'] ELEVATION)
- F NOT USED
- G NOT USED
- H TRANSITIONAL SURFACE (2:1 SLOPE RATIO)
- I NOT USED
- J ACCIDENT POTENTIAL ZONE (APZ) (NOT SHOWN)

ISOMETRIC

N.T.S.

Figure 8-50. OLF Facility Imaginary Surfaces

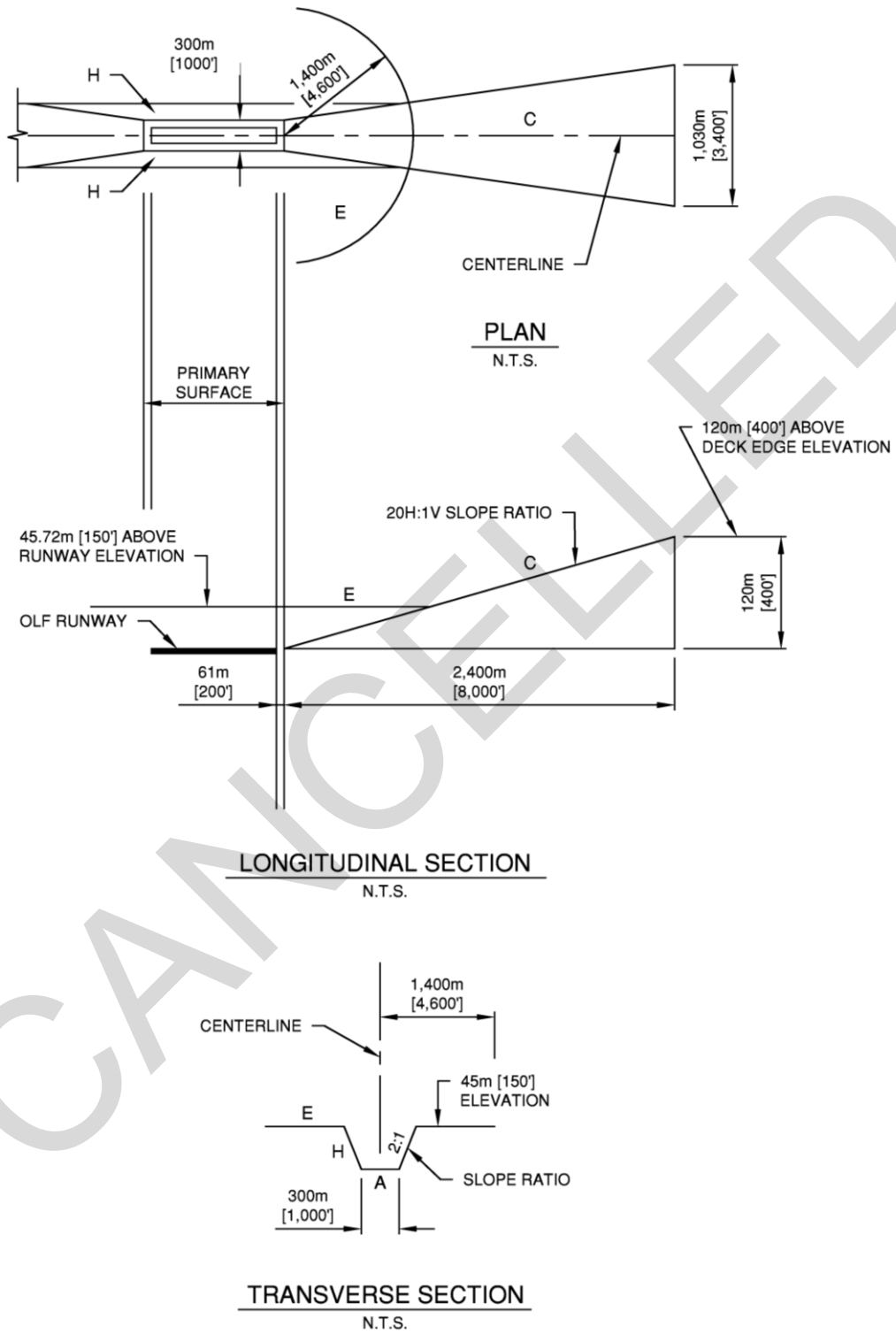
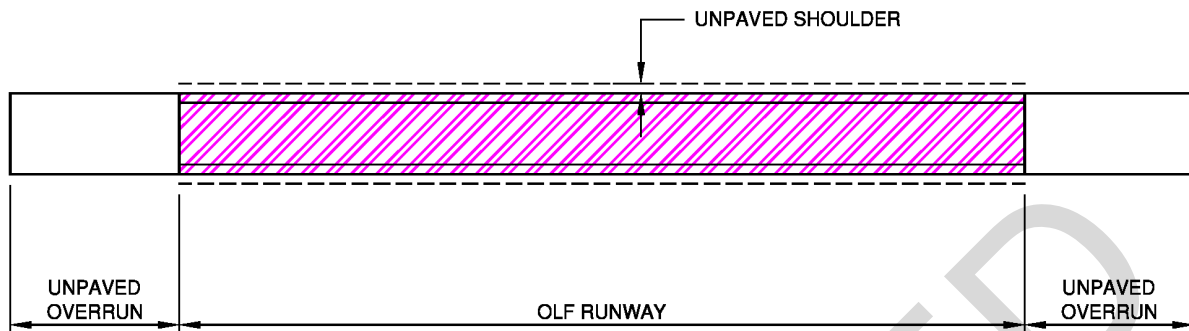

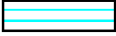



Figure 8-51. Tilt-Rotor OLF Pavement Surface Types



-  CONTINUOUSLY REINFORCED HIGH TEMPERATURE CONCRETE (CRHTC)
-  PLAIN JOINTED HIGH TEMPERATURE CONCRETE (PJHTC)
-  PLAIN JOINTED HIGH TEMPERATURE CONCRETE (PJHTC) OR PLAIN JOINTED PORTLAND CEMENT CONCRETE (PJPC)
-  ASPHALT CONCRETE (AC), PLAIN JOINTED PORTLAND CEMENT CONCRETE (PJPC), OR PLAIN JOINTED HIGH TEMPERATURE CONCRETE (PJHTC)

CANCELLED

## CHAPTER 9 UNMANNED AIRCRAFT SYSTEMS (UAS)

### 9-1 CONTENTS.

This chapter presents guidance and criteria for planning and designing runway and ancillary movement areas that support operations of US Army (USA)/US Air Force (USAF)/US Navy wheeled/skid Unmanned Aircraft Systems (UAS).

### 9-2 REQUIREMENTS. LAND USE AND AIRSPACE APPROVAL.

[Public Aircraft Operations](#) are limited by federal statute to certain government operations within U.S. airspace per Federal Aviation Administration (FAA) proposed rules.

### 9-3 RUNWAY.

Runway location and orientation are paramount to airfield safety for UAS aircraft. Wind direction and velocity is a major consideration for siting runways. With respect to UAS operations, prevailing winds and velocities may actually prevent operations if the runway cannot be aligned with them. To be functional, efficient, and safe, the runway should be oriented in alignment with the prevailing winds, to the greatest extent practical, to provide favorable wind coverage. Wind data, obtained from local sources, for a period of not less than five years, should be used as a basis for developing the wind rose to be shown on the airfield general site plan. Appendix B, Section 4, provides guidance for the research, assessment, and application of wind data. NOTE: For RQ-7Bv2, the term “runway” in this chapter shall be synonymous with “launch/recovery strip” and the term “hangar” shall be synonymous with “shelter.”

### 9-4 AIRCRAFT COVERED IN THIS CHAPTER.

- MQ-9A Reaper
- MQ-1B Predator
- MQ-1C Gray Eagle
- RQ-4A/B Global Hawk
- MQ-4C Triton
- RQ-7Bv2 Shadow (or earlier versions)
- MQ-8B/C Fire Scout

### 9-5 AIRCRAFT CHARACTERISTICS.

For aircraft characteristics see USACE Technical Report TSC 13- 2.

### 9-6 AIRFIELD DIMENSIONAL CRITERIA.

The dimensions for airfield facilities, airfield lateral safety clearances, and airspace imaginary surfaces are provided in this document. Typical layout, sections and profiles for UAS runways and the associated airspace surfaces are shown in Figures 9-1 through 9-6.

#### **9-6.1 Airfields/Heliports Used by Both Manned and Unmanned Aircraft.**

Airfields/Heliports, Air Force Bases, Naval Air Stations and Marine Corps Air Stations used by both manned and unmanned aircraft (dual use facilities) will use the geometric criteria contained in this UFC. The most critical criteria (**manned versus unmanned aircraft criteria**) will apply based on the segment use, it may even be a combination of UAS Criteria, i.e. the taxiway to the UAS apron will be designed based on this UFC. The RQ-4A/B and MQ-4 require a Class B runway. New pavements for UAS aircraft at manned aircraft facilities shall be designed in accordance with the requirements in UFC 3-260-02. Chapter 1 of UFC 3-260-02 details which pavements must be rigid pavements and which pavements can be either rigid or flexible pavements. The traffic mix utilized for the installation shall be used for these new UAS pavements (installation traffic mixes are spelled out in UFC 3-260-02 Chapter 2 for Army Class I, II, III, IV and in Chapter 3 for USAF medium, light, heavy, etc.).

#### **9-6.2 Permissible Deviations from Design Criteria.**

See paragraph B13-2.16 for deviations from criteria.

#### **9-6.3 UAS Runway Co-located with an Active Army Airfield, Army Heliport, Air Force, Navy or Marine Corps Runway.**

##### **9-6.3.1 Separation Criteria.**

Table 9-1 lists the separation criteria between manned and unmanned runways. If the UAS facility is planned for dual use, the requirements of this UFC, UFC 3-535-01 and appropriate service marking directives apply.

##### **9-6.3.2 New Pavements.**

New pavements for UAS aircraft at collocated facilities shall be designed in accordance with the requirements in UFC 3-260-02. Chapter 1 of UFC 3-260-02 details which pavements must be rigid pavements and which pavements can be either rigid or flexible pavements. The traffic mix used for UAS only pavements shall be, as a minimum, the same as the traffic used for an Army Class II Helipad (20,000 passes of a 22,680kg [50,000lb] CH-47 Aircraft). If other support vehicles (i.e. crash fire trucks, support trucks, forklifts, etc.) utilize these areas that require a thicker pavement design then the thickened design for those vehicles shall govern.

**Table 9-1. Separation Distance Between Runways**

Table 9-1. Separation Distance Between Runways	
Min. 213.4m [700 ft]	Non-simultaneous Visual Flight Rules (VFR) operations.
Min. 304.8m [1000 ft]	Simultaneous VFR operations
Min. 762m [2500 ft]	Instrument Flight Rules (IFR)/VFR using simultaneous operations (depart-depart) (depart-approach).
Concurrent UAS Ops	The separation distance between multiple runways that are going to be used for UAS aircraft operations will need to be coordinated with the UAS Program Managers (operating multiple TALS in close proximity to each other may create radar signature interferences or conflicts for approaching UAS aircraft).

**9-6.4 UAS-only Facilities.**

This section presents design considerations for UAS only facilities. See TC 25-8 *Training Ranges* for additional RQ-7Bv2 Shadow facility design criteria, especially expeditionary training and/or semi-improved training facilities.

**9-6.4.1 New Pavements.**

New pavements for UAS aircraft at these facilities shall be designed in accordance with the requirements in UFC 3-260-02. Chapter 1 of UFC 3-260-02 details which pavements must be rigid pavements and which pavements can be either rigid or flexible pavements. The traffic mix used for UAS only pavements shall be, as a minimum, the same as the traffic used for an Army Class II Helipad (20,000 passes of a 22,680kg [50,000lb] CH-47 Aircraft). If other support vehicles (i.e. crash fire trucks, support trucks, forklifts, etc.) utilize these areas that require a thicker pavement design then the thickened design for those vehicles shall govern.

**9-6.4.2 Runway Designation.**

For runway designation see UFC 3-260-04. These runways are not built structurally to support standard fixed wing or rotary aircraft operations.

**9-6.4.3 Tactical Shadow Facility.**

Down range tactical facilities are rudimentary in nature to enable launch/recovery and provide basic shelter to support training operations. These facilities are permanent sites that are constructed on installation range complexes to enable launch and recovery under the veil of installation restricted airspace. Tactical facilities must be configured IAW Operators Manual requirements for tactical use. Building structures should be sited to comply with Table 9-6.

Table 9-2. UAS Runways

Table 9-2. UAS Runways					
	Item	Criteria			Remarks
No.	Description	MQ-1	RQ-7Bv2	MQ-9	
1	Length (min)	1524m [5000']	243.84m [800']	2286m [7500']	MQ-1C: 1371.6m [4500'], at 2743.2m [9000'] elevation runway length is 1676.4m [5500']. For USAF required length shall be determine by the A2, but not less than stated except for lengths in Appendix B.  For RQ-7, length of runway will depend on the number of TALs touch down points. 243.84m [800'] is only adequate for one touch point. Increase runway length to 304.8m [1,000'] for two or more platoons.
2	Width	22.86m [75']	15.24m [50']	22.86m [75']	MQ-1C 30.48m [100']
3	Width of shoulder	3.05m [10']	1.52m [5']	3.05m [10']	Shoulder may be paved or unpaved.
4	Longitudinal grades of runway and shoulders	Grades may be both positive and negative but must not exceed the limit specified in this UFC. Shadow can operate on a max grade of 1.7%. Grade restrictions are exclusive of other pavements and shoulders. Where other pavements tie into runways, comply with grading requirements for towways, taxiways, or aprons as applicable, but hold grade changes to the minimum practicable to facilitate drainage.			
5	Longitudinal runway grade changes	No grade change is to occur less than 304.8m [1,000'] from the runway end	No grade change is to occur less than 30.48m [100'] from the runway end	No grade change is to occur less than 304.8m [1,000'] from the runway end	Where economically feasible, the runway will have a constant centerline gradient from end to end. Where terrain dictates the need for centerline grade changes, the distance between two successive points of intersection (PI) will be not less than 304.8m [1,000'] (MQ-1 and MQ-9), 30.48m [100'] (RQ-7A/B) and two successive distances between PIs will not be the same.
6	Rate of longitudinal runway grade changes	Maximum rate of longitudinal grade change is produced by vertical curves having 180-m [600-ft] lengths for each percent of algebraic difference between the two grades.			
7	Longitudinal sight distance	Any two points 2.44m [8'] above the pavement must be mutually visible (visible by each other) for 1524m [5000'].  Proportionally reduce height above runway for runways shorter than 1524m [5,000'].			



Table 9-2. UAS Runways					
No.	Item Description	Criteria			Remarks
		MQ-1	RQ-7Bv2	MQ-9	
8	Transverse grade of runway	Min 1.0% Max 1.5%	Max 0.5%	Min 1.0% Max 1.5%	Runway pavements will be centerline crowned. Slope pavement downwards from centerline of runway. 1.5% slope is optimum transverse grade of runway.
9	Transverse grade of paved shoulder	Slope downward from runway pavement. Reversals are not allowed.			
10	Runway lateral clearance zone width (from centerline)	76.2m [250']	18.29m [60']	76.2m [250']	<p>The runway lateral clearance limits coincide with the limits of the primary surface. The ends of the lateral clearance zone coincide with the runway ends plus overruns. The ground surface within this area must be clear of fixed or mobile objects, and graded to the requirements in Table 3-2, items 13 and 14, Chapter 3.</p> <p>The zone width is measured perpendicularly from the centerline of the runway and begins at the runway centerline.</p> <p>(1) Fixed obstacles include man-made or natural features such as buildings, trees, rocks, terrain irregularities and any other features constituting possible hazards to moving aircraft.</p> <p>(2) Mobile obstacles include parked aircraft, parked and moving vehicles, railroad cars, and similar equipment. Taxiing aircraft, emergency vehicles, and authorized maintenance vehicles are exempt.</p> <p>(3) Parallel taxiway (exclusive of shoulder width) will be located in excess of the lateral clearance distances (primary surface).</p> <p>(4) Above ground drainage structures, including headwall, are not permitted within 45.72m [150'] (24.38m [80'] for RQ-7) of the runway centerline.</p>
11	Longitudinal grades within runway lateral clearance zone	Exclusive of pavement, shoulders, and cover over drainage structures. Slopes are to be as gradual as practicable. Avoid abrupt changes or sudden reversals. Rough grade to the extent necessary to minimize damage to aircraft.			

Table 9-2. UAS Runways					
No.	Item Description	Criteria			Remarks
		MQ-1	RQ-7Bv2	MQ-9	
12	Transverse grades within runway lateral clearance zone (in direction of surface drainage)	Exclusive of pavement, shoulders, and cover over drainage structures. Slopes are to be as gradual as practicable. Avoid abrupt changes or sudden reversals. Rough grade to the extent necessary to minimize damage to aircraft. Grades may need to be adjusted as necessary to accommodate siting of RQ-7 TALS, but shall be done in accordance with these requirements.			
13	Width of mandatory frangibility zone (MFZ)	91.44m [300']	NA*	91.44m [300']	Centered on the runway centerline. All items sited within this area must be frangible. (See Appendix B, Section 13.).
14	Length of MFZ	Extends the entire length of the runway plus clear zone. Items that must be sited there due to their function must be made frangible to the maximum extent possible.(See Appendix B, Section 13)*			

\* For the RQ-7 runways no objects except for the arresting system and barrier net may be placed within the primary surface.

CANCELLED

Figure 9-1. MQ-1/9 Predator/Gray Eagle/Reaper Primary Surface End Details

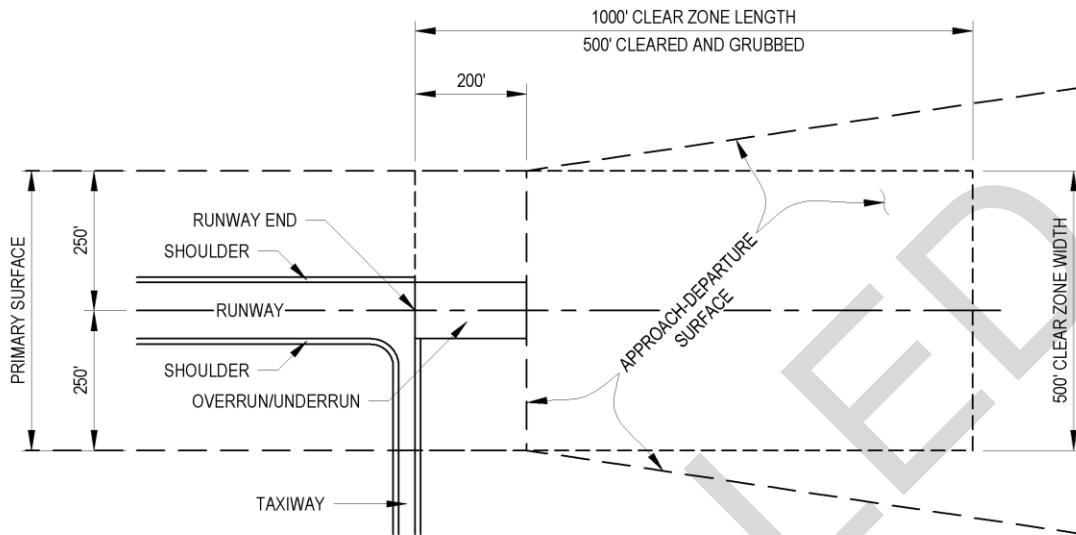

Figure 9-2. RQ-7Bv2 Shadow Primary Surface End Details

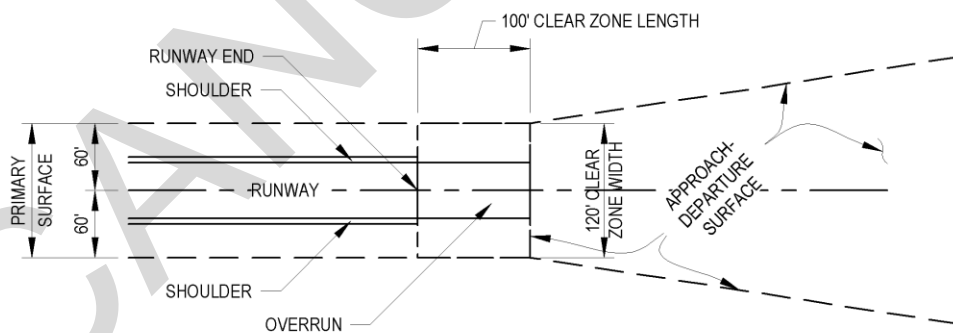
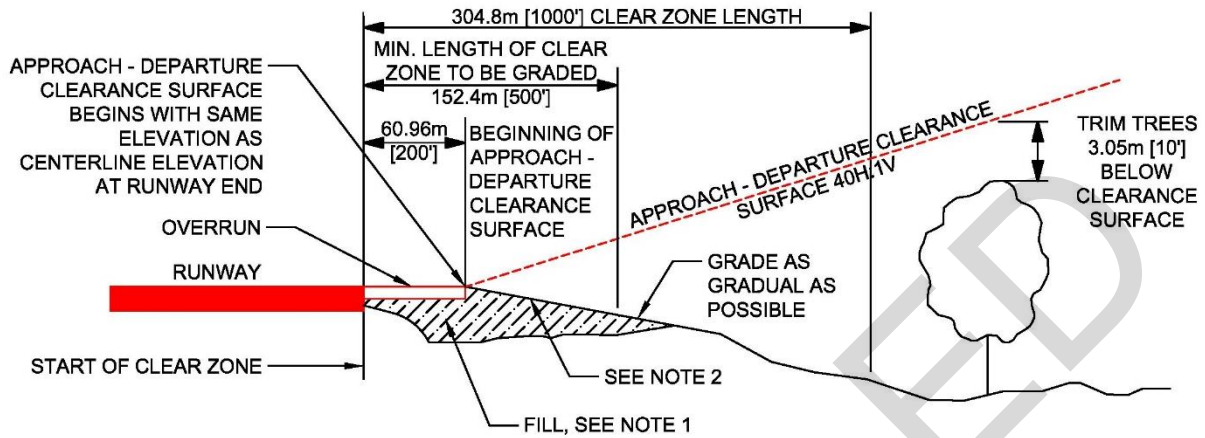

Figure 9-3. MQ-1/9 Predator/Gray Eagle/Reaper Approach-Departure Clearance Surface Profile



NOTE:

1. WHERE EXISTING GROUND IS ABOVE THE APPROACH - DEPARTURE SURFACE, CUT WILL BE REQUIRED. WHERE THE EXISTING GROUND IS BELOW APPROACH - DEPARTURE SURFACE, FILL AS NECESSARY TO MEET GRADE REQUIREMENTS.
2. FOLLOW CLEAR ZONE GRADING REQUIREMENTS.

OVERRUN FILL PROFILE

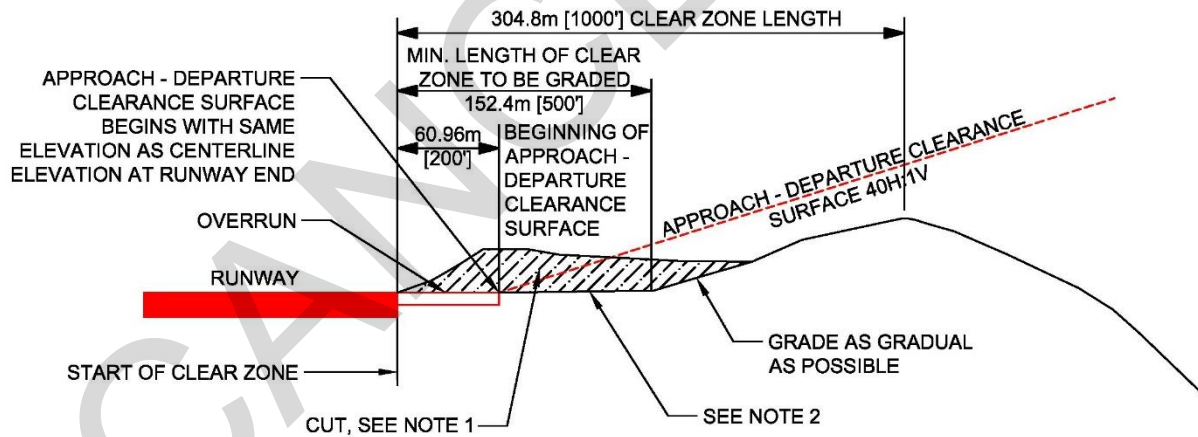

OVERRUN CUT PROFILE

Figure 9-4. RQ-7Bv2 Shadow Approach-Departure Clearance Surface Profile

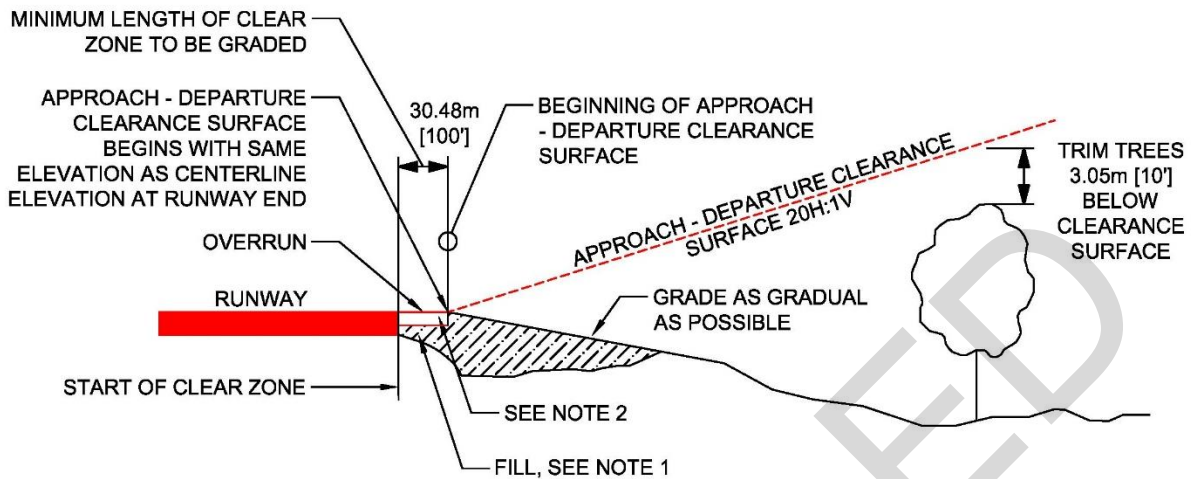

NOTE:

1. WHERE EXISTING GROUND IS ABOVE THE APPROACH - DEPARTURE SURFACE, CUT WILL BE REQUIRED. WHERE THE EXISTING GROUND IS BELOW APPROACH - DEPARTURE SURFACE, FILL AS NECESSARY TO MEET GRADE REQUIREMENTS.
2. FOLLOW CLEAR ZONE GRADING REQUIREMENTS.

OVERRUN FILL PROFILE

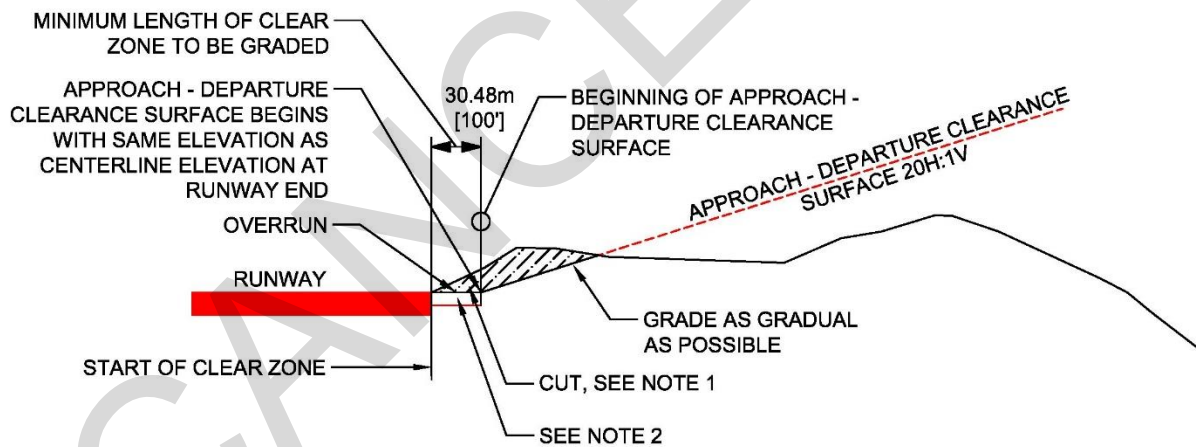

OVERRUN CUT PROFILE

Figure 9-5. MQ-1/9 Predator/Gray Eagle/Reaper Runway Isometric Airspace Imaginary Surfaces

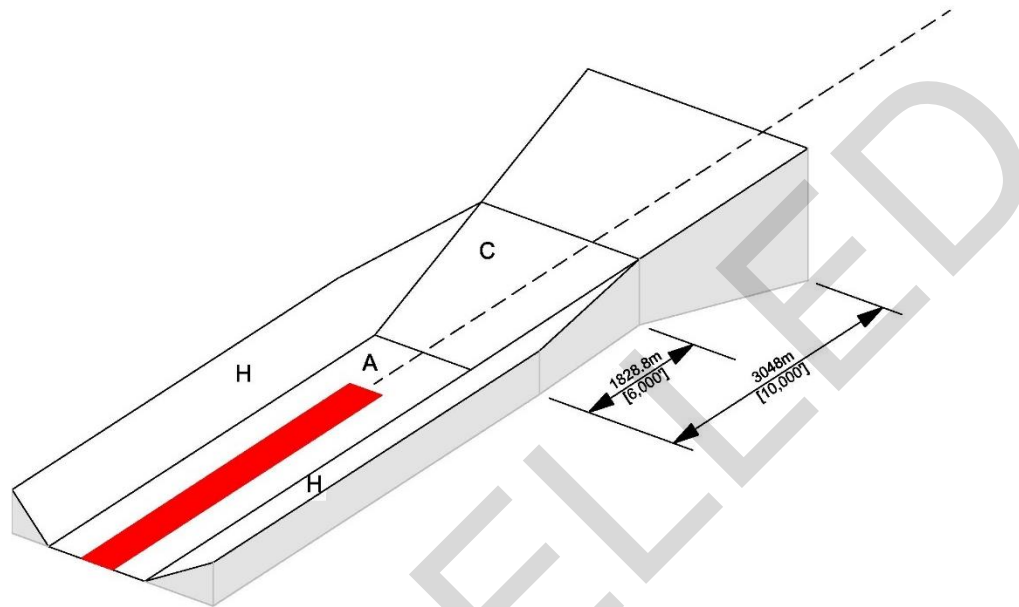

**LEGEND**

- A. PRIMARY SURFACE.
- B. CLEAR ZONE SURFACE (NOT SHOWN).
- C. APPROACH-DEPARTURE CLEARANCE SURFACE (40H:1V SLOPE RATIO).
- D. APPROACH-DEPARTURE CLEARANCE SURFACE (HORIZONTAL, NOT REQUIRED).
- E. INNER HORIZONTAL SURFACE (NOT REQUIRED).
- F. CONICAL SURFACE (NOT REQUIRED).
- G. OUTER HORIZONTAL SURFACE (NOT REQUIRED).
- H. TRANSITIONAL SURFACE (4H:1V SLOPE RATIO).
- I. NOT USED.

Figure 9-6. MQ-1/9 & RQ-7Bv2 Runway Plan and Profile Airspace Imaginary Surfaces

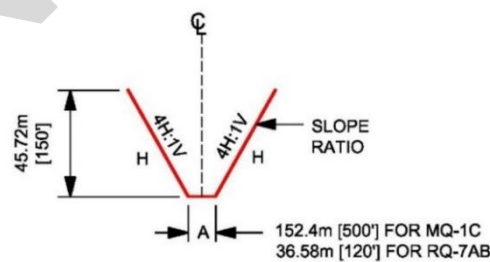
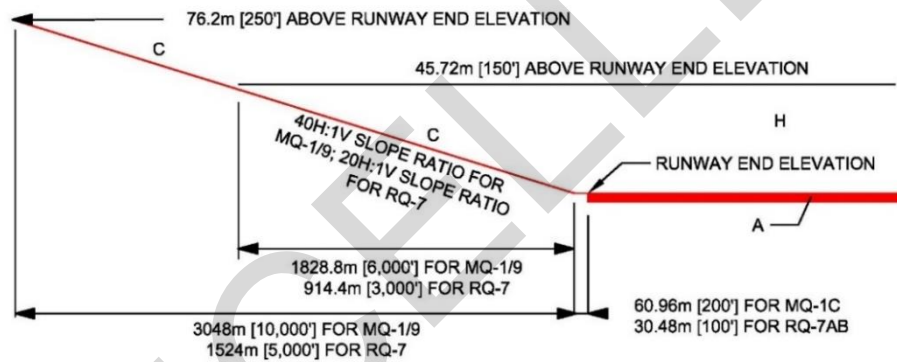
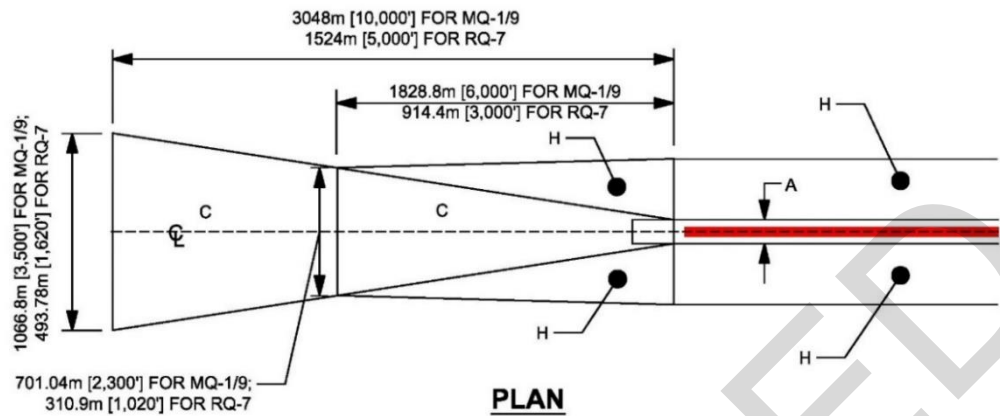

**LEGEND:**

- A - PRIMARY SURFACE.
- B - CLEAR ZONE SURFACE.
- C - APPROACH-DEPARTURE CLEARANCE SURFACE (40H:1V FOR MQ-1/9 & 20H:1V FOR RQ-7).
- H - TRANSITIONAL SURFACE (4H:1V SLOPE RATIO).

**NOTES:**

1. DATUM ELEVATION FOR SURFACE C IS THE RUNWAY CENTERLINE ELEVATION AT THE THRESHOLD. SURFACE H VARIES AT EACH POINT.

### 9-6.5 Runway Overruns.

Runway overruns keep the probability of serious damage to an aircraft to a minimum in the event that the aircraft runs off the runway end during a takeoff or landing, or lands short during a landing. Overruns are required for the landing and takeoff area.

**Table 9-3. UAS Overruns**

Table 9-3. Overruns					
Item		MQ-1	RQ-7Bv2	MQ-9	Remarks
No.	Description	Requirement			
1	Length	60.96m [200']	30.48m [100']	60.96m [200']	
2	Paved Length	60.96m [200']	30.48m [100']	60.96m [200']	If runway is paved, overrun will be paved.
3	Total width of overrun (paved and unpaved)	Sum of runway and shoulders			The outside edges of the overrun, equal in width to the runway shoulder, are graded but not paved.
4	Paved overrun width	Same as width of runway			Center on runway centerline extended.
5	Longitudinal centerline grade	Same as last 304.8m [1,000'] of runway	Same as last 30.48m [100'] of runway	Same as last 304.8m [1,000'] of runway	To avoid abrupt changes in grade between the first 91.44m [300'] and remainder of overrun the maximum change of grade is 2.0% (1.7% for RQ-7) per 30.48 linear meter [100 linear ft.]
6	Transverse grade	Min 2.0% Max 3.0%  (1.7% max for RQ-7) 1.5 in drop-off at edge of paved overrun +/- 0.5 in			From centerline of overrun. Transition from the runway and runway shoulder grades to the overrun grades to be made within the first 15.24m [50'] of overrun.

### 9-6.6 Runway Clear Zones.

Runway clear zones are areas on the ground, located at the ends of each runway. They possess a high potential for accidents, and their use is restricted to be compatible with aircraft operations. Hence, they are treated as "exclusion zones" and not merely restricted access. Runway clear zones are required for the runway and should be owned or protected under a long-term lease.

#### 9-6.6.1 Treatment of Clear Zones.

The purpose of the clear zone is to protect the safety of flight and safety of people on the ground. The entire clear zone area is a land use control area intended to protect people both flight safety and property on the ground. Land use for the clear zone area for UAS facilities corresponds to the clear zone land use criteria for fixed-wing airfields



as defined for DoD AICUZ and Service-specific standard and as discussed in Chapter 3.

**9-6.6.2 Clear Zone Mandatory Frangibility Zone (MFZ).**

The MFZ extends through the graded area. Items that must be sited there due to their function must be made frangible to the maximum extent possible (Appendix B, Section 13).

**9-6.6.3 Prohibited Land Uses.**

Criteria prohibits certain land uses within the clear zone and APZs (APZ I and APZ II). These land uses include storage and handling of munitions and hazardous materials, and live fire weapons ranges (See DoDI 4165.57 and individual service component directives and DA PAM 385-63 for more information on compatible land use).

**Table 9-4. UAS Clear Zones**

Table 9-4. UAS Clear Zones					
Item No.	Description	MQ-1	RQ-7Bv2	MQ-9	Remarks
		Requirement			
1	Length	304.8m [1000']	30.48m [100']	304.8m [1000']	Measured along the extended runway centerline beginning at the runway end. For grading requirements, see items 4 and 5.
2	Width at start of clear zone (adjacent to the runway)	152.4m [500']	36.58m [120']	152.4m [500']	Centered on the runway center line extended.
3	Length of Graded Clear zone surface (graded area)	152.4m [500']	30.48m [100']	152.4m [500']	Graded area only. For land use outside the graded area of the clear zone, apply AICUZ standards.
4	Width at end of clear zone	152.4m [500']	36.58m [120']	152.4m [500']	Centered on the runway center line extended.
5	Longitudinal grade of area to be graded	Max 10.0%	Max 1.7%	Max 10.0%	The area to be graded is 152.4m [500'] (MQ-1, MQ-9), and 30.48m [100'] (RQ-7) in length by the established width of the primary surface. Grades are exclusive of the overrun, but are to be shaped into the overrun grade. The maximum longitudinal grade change cannot exceed + 2.0% per 30.48m [100']. Grade restrictions are also exclusive of other pavements and shoulders. Where other pavements cross the graded area, comply with grading requirements for the specific pavement design (towways, taxiways, or aprons as

**Table 9-4. UAS Clear Zones**

Item No.	Description	MQ-1	RQ-7Bv2	MQ-9	Remarks
		Requirement			
					applicable), but hold grade changes to the minimum practicable to facilitate drainage. The graded area is to be cleared and grubbed of stumps and free of abrupt surface irregularities, ditches, and ponding areas. No aboveground structures, objects, or roadways (except air traffic control controlled service roads to arresting gear are permitted in the area to be graded, but gentle swales, subsurface drainage, covered culverts and underground structures are permissible. The transition from the graded area to the remainder of the clear zone is to be as gradual as feasible. For policy regarding permissible facilities, geographical features, and land use in the remainder of the clear zone, refer to guidance furnished by the DoD AICUZ guidelines for clear zones and accident potential zones. (See Appendix B, Section 3.)
6	Transverse grade of area to be graded (in direction of surface drain-age prior to channelization)	Min 2.0% Max 10.0%			For RQ-7 Max 1.7%
7	Width of MFZ	91.44m [300']	NA	91.44m [300']	Centered on the extended runway centerline. All items sited within the MFZ in the graded area of the clear zone must be frangible. Items located beyond the Graded Area of the clear zone but within the MFZ must be constructed to be frangible, low impact resistant structures, or semi-frangible (see Appendix B, Section 13).
8	Length of MFZ	152.4m [500']	NA	152.4m [500']	Extends the full length of the runway plus the clear zone.

**Table 9-5. UAS Accident Potential Zones**

Table 9-5. UAS Accident Potential Zones					
Item		MQ-1	RQ-7Bv2	MQ-9	Remarks
No.	Description	Requirement			
1	APZ I length	457.2m [1500']			<p>APZ I starts at the end of the clear zone, and is centered and measured on the extended centerline. Modifications will be considered if:</p> <ul style="list-style-type: none"> <li>- The runway is infrequently used.</li> <li>- Prevailing wind conditions are such that a large percentage (that is, over 80%) of the operations are in one direction.</li> <li>- Local accident history indicates consideration of different areas.</li> <li>- Most aircraft do not overfly an APZ area as defined here during normal flight operations (modifications may be made to alter these zones and adjust them to conform to the line of flight).</li> <li>- Other unusual conditions exist.</li> </ul>
2	APZ I width	152.4m [500']	36.58m [120']	152.4m [500']	
3	APZ II length	304.8m [1000']			<p>APZ II starts at the end of the APZ I and is centered and measured on the extended runway centerline. Modifications will be considered if:</p> <ul style="list-style-type: none"> <li>- The runway is infrequently used.</li> <li>- Prevailing wind conditions are such that a large percentage (that is, over 80 percent) of the operations are in one direction.</li> <li>- Local accident history indicates consideration of different areas.</li> <li>- Most aircraft do not overfly an APZ area as defined here during normal flight operations (modifications may be made to alter these zones and adjust them to conform to the line of flight).</li> <li>- Other unusual conditions exist.</li> </ul>
4	APZ II width	152.4m [500']	36.58m [120']	152.4m [500']	

Table 9-6. UAS Airspace Imaginary Surfaces

Table 9-6. Airspace Imaginary Surfaces (See Figures 9-1 thru 9-6)						
Item		Legend	UAS Runway			Remarks
No.	Description		MQ-1	RQ-7Bv2	MQ-9	
1	Primary surface width	A	152.4m [500']	36.58m [120']	152.4m [500']	Centered on the runway centerline.
2	Primary surface length	A	60.96m [200']	36.58m [100']	60.96m [200']	Runway length plus value indicated on each end of the runway (extends beyond each end of the runway).
3	Primary surface elevation	A	The elevation of any point on the primary surface is the same as the elevation of the nearest point on the runway centerline.			
4	Clear zone surface (graded area)	B	152.4m [500']	30.48m [100']	152.4m [500']	For land use outside the graded area of the clear zone, apply AICUZ standards.
5	Start of approach-departure surface	C	60.96m [200']	30.48m [100']	60.96m [200']	Measured from the end of the runway.
6	Length of sloped portion of approach-departure surface	C	3048m [10,000']	1524m [5,000']	3048m [10,000']	Measured horizontally. For MQ-1C the length can be reduced to 1851.96m [6,076'].
7	Slope of approach-departure surface	C	40:1	20:1	40:1	Slope ratio is horizontal: vertical. Example: 40:1 is 12.19m [40'] horizontal to 0.30m [1'] vertical. For clearances over highway and railroads, see Table 3-8.
8	Width of approach-departure surface at start of sloped portion	C	152.4m [500']	36.58m [120']	152.4m [500']	Centered on the extended runway centerline, and is the same width as the Primary Surface.
9	Width of approach-departure surface at end of sloped portion	C	1066.8m [3500']	493.78m [1620']	1066.8m [3500']	Centered on the extended runway centerline. For MQ-1C the width can be reduced to 354m [1,161.4']
10	Elevation of approach-departure	C	Same as the runway centerline elevation at the threshold.			

**Table 9-6. Airspace Imaginary Surfaces (See Figures 9-1 thru 9-6)**

Item		Legend	UAS Runway			Remarks
No.	Description		MQ-1	RQ-7Bv2	MQ-9	
	surface at start of sloped portion					
11	Elevation of approach-departure surface at end of sloped portion	C	76.2m [250']			Above the established airfield elevation.
12	Start of transitional surface	H	76.2m [250']	18.29m [60']	76.2m [250']	Measured from runway centerline.
13	End of transitional surface	H	See Remarks			The transitional surface ends at the inner horizontal surface, conical surface, outer horizontal surface, or at an elevation of 45.72m [150'].
14	Slope of transitional surfaces	H	4:1			Slope ratio is horizontal:vertical. 4:1 is 1.22m [4'] horizontal to 0.30m [1'] vertical. Vertical height of vegetation and other fixed or mobile obstacles and/or structures will not penetrate the transitional surface. Taxiing aircraft are exempt from this requirement.

**NOTE:** See Figures 9-1 & 9-6

## **9-7 TAXIWAYS.**

Taxiways provide for ground movement of aircraft. Taxiways connect the runway(s) of the airfield with the parking and maintenance areas and provide access to hangars, docks, and various parking aprons and pads. Taxiways are designated alphabetically, avoiding the use of I, O, (could be mistaken for runway numbers) and X (closure marking). Alphanumeric designations may be used when necessary, for example, A1, B3. RQ-7A/B do not require taxiways, however do require paved towways for wing walkers.

### **9-7.1 Basic.**

The basic airfield layout consists of a taxiway connecting the center of the runway with the hangar access apron. This system limits the number of aircraft operations at an airfield. Departing aircraft must taxi on the runway to reach the runway threshold. When aircraft are taxiing on the runway, no other aircraft is allowed to use the runway. If

runway operations are minimal or capacity is low, the basic airfield layout with one taxiway may be an acceptable layout.

### **9-7.2 Parallel Taxiway.**

A taxiway parallel for the length of the runway, with connectors to the end of the runway and hangar access apron, is the most efficient taxiway system. Aircraft movement is not hindered by taxiing operations on the runway, and the connectors permit rapid entrance and exit of traffic.

### **9-7.3 Taxiway Intersection Criteria.**

To prevent the main gear of an aircraft from coming dangerously close to the outside edge of the taxiway during a turn, fillets are provided at taxiway intersections. When an aircraft turns at an intersection, the nose gear of the aircraft usually follows the painted centerline marking. The main gears, located to the rear of the nose gear, do not remain a constant distance from the centerline stripe during the turn due to the physical design of the aircraft. The main gears pivot on a shorter radius than does the nose gear during a turn. Intersections should be designed to ensure that the main gear wheels stay a minimum of 5 feet from the pavement edge.

### **9-7.4 Hangar Access Taxiways.**

Hangar access taxiways are provided for aircraft access onto a hangar access apron. The apron access taxiways should be located to enhance the aircraft's departing sequence and route.

### **9-7.5 Shoulders.**

Shoulders are provided along a taxiway to allow aircraft to recover if they leave the paved taxiway. Paved shoulders prevent erosion caused by prop wash, support an occasional aircraft that wanders off the taxiway, support vehicular traffic, and reduce maintenance of unpaved shoulder areas. Criteria for UAS taxiway shoulders, including widths and grading requirements to prevent the ponding of storm water, are presented in Table 9-7. Manholes, hand holes, and drainage structures constructed within these areas should, at a minimum, be designed as provided in this section. Beyond the paved or unpaved shoulders, sub-grade structures are not designed to support aircraft wheel loads. The top surface of foundations, manhole covers, hand hole covers, and frames should be flush with the grade. Maintenance action is required if the drop-off at the edge of the structure or foundation exceeds three inches.

**Table 9-7. UAS Taxiways**

Table 9-7. UAS Taxiways				
Item		MQ-1/9	RQ-7Bv2	Remarks
No.	Description	Requirement		
1	Width (ft)	15.24m [50']	4.57m [15']	9.14m [30'] for MQ-1C
2	Total width of shoulders (paved and unpaved) (ft)	3.05m [10']	NA	Any or all of the shoulders may be paved or unpaved. For unpaved shoulders turfed/grassed shoulders are recommended except in desert locations where gravel surfacing is also acceptable.
3	Longitudinal grade of taxiway and shoulders	Max 3.0%		Grades may be positive or negative but must not exceed the limits specified.
4	Rate of longitudinal taxiway grade change	Max 2.0% per 30.48m [100']	NA	The minimum distance between two successive points of intersection (PI) is 152.4m [500']. Changes are to be accomplished by means of vertical curves. Up to a 0.4% change in grade is allowed without a vertical curve. A vertical curve is not necessary where a taxiway crosses a runway or taxiway crown..
5	Transverse grade of taxiway	Min 1.0% Max 1.5%	NA	Taxiway pavements will be centerline crowned. Slope pavement downward from the centerline of the taxiway. When existing taxiway pavements have insufficient transverse gradients for rapid drainage, provide for increased gradients when the pavements are overlaid or reconstructed. The transverse gradients requirements are not applicable at or adjacent to intersections where pavements must be warped to match abutting pavements.
6	Transverse grade of optional paved shoulders	Min 2.0% Max 4.0%	NA	
7	Transverse grade of unpaved shoulders	40mm [1.5"] drop-off at edge of pavement +/- 13mm [0.5"] 2.0% min, 4.0% max	NA	Unpaved shoulders shall be graded to provide positive surface drainage away from paved surfaces.

Table 9-7. UAS Taxiways				
Item		MQ-1/9	RQ-7Bv2	Remarks
No.	Description	Requirement		
8	Taxiway turning radius (ft)	19.81m [65']	NA	
9	Fillet radius at intersections (ft)	15.24m [50']	NA	
10	Clearance from edge of access apron to other taxiways and aprons (ft)	30.48m [100']	NA	Where hover taxi is involved the minimum distance is 60.96m [200']
11	Clearance from taxiway centerline to fixed or mobile obstacles (taxiway clearance line) (ft)	30.48m [100']	NA	
12	Distance between taxiway centerline and parallel taxiway/taxilane centerline (ft)	38.1m [125']	NA	
13	Grade of area between taxiway shoulder and taxiway clearance line	Min of 2.0% prior to channelization Max 10.0%		Unpaved areas shall be graded to provide positive surface drainage away from paved surfaces. 40mm [1.5"] drop-off at pavement edge, +/- 13mm [0.5"]

## 9-7.6 Towways.

A towway is used to tow aircraft from one location to another or from the runway/taxiway to a hangar/storage facility.

### 9-7.6.1 Dimensions.

Table 9-8 presents the criteria for towway layout and design, including clearances, slopes, and grading dimensions. When designing for access to a hangar, flare the pavement to the width of the hangar door from a distance beyond the hangar sufficient to allow maintenance personnel to turn the aircraft around.



**Table 9-8. UAS Toweys**

Table 9-8. UAS Toweys				
Item		MQ-1/9	RQ-7A/B	Remarks
No.	Description	Requirement		
1	Width (ft)	9.14m [30']	4.57m [15']	RQ-7 requires a paved towway.
2	Total width of shoulders (ft)	3.05m [10']	3.05m [10']	Any or all of the shoulders may be paved or unpaved. For unpaved shoulders turfed/grassed shoulders are recommended except in dessert locations where gravel surfacing is also acceptable.
3	Longitudinal grade of towway	Max 3.0%		Grades may be both positive and negative but must not exceed the limit specified.
4	Rate of longitudinal grade change per 30 m (100 ft)	Max 2.0%		The minimum distance between two successive PI is 150 m (500 ft). Changes are to be accomplished by means of vertical curves.  For the Air Force and Army, up to a 0.4% change in grade is allowed without a vertical curve. A vertical curve is not necessary where a taxiway crosses a runway or taxiway crown.
5	Longitudinal sight distance	N/A (See note 1.)		
6	Transverse grade	Min 1.0% Max 3.0%		Pavement crowned at towway centerline. Slope pavement downward from centerline of towway.
7	Towway turning radius (ft)	27.43m [90']	15.24m [50']	Criteria presented here are for straight sections of towway. Pavement width and horizontal clearance lines may need to be increased at horizontal curve locations, based on aircraft alignment on the horizontal curve.
8	Fillet radius at intersections (ft)	15.24m [50']	9.14m [30']	
9	Transverse grade of shoulder	(a) 40 mm (1.5 in) drop-off at edge of pavement, +/- 13 mm (0.5 in).  (b) 2.0% min, 4.0% max.		
10	Horizontal clearance from towway centerline to fixed or mobile obstacles	The greater of: ½ the wing width of the towed +25 ft.; or the minimum of 18.29m [60'].		
11	Vertical clearance from towway pavement surface to fixed or mobile obstacles	(Height of towed mission aircraft) + 3 m (10 ft)		

12	Grade (area between towway shoulder and towway clearance line)	Min of 2.0% prior to channelization Max 10%. (See note 2.)	
----	--	--	--

**NOTES:**

1. N/A = not applicable
2. Bed of channel may be flat.

**9-8 APRONS AND OTHER PAVEMENTS.**

**9-8.1 Apron Requirements.**

Aprons should be sized to allow safe movement of towed aircraft or aircraft operating under their own power.

**9-8.1.1 Location.**

Aprons should be located contiguous to maintenance and hangar facilities. Do not locate them within runway and taxiway lateral clearance distances. A typical access apron is illustrated in Figure 9-9. (For Army, based on Vice Chief of Staff of the Army (VCSA) approval of concept, there is no aircraft parking apron authorized for Army UAS.)

**9-8.1.2 Size.**

As a general rule, there are no standard sizes for aircraft aprons. Aprons are individually designed to support aircraft and missions at specific facilities. The actual dimensions of an apron are based on the number of authorized aircraft, the maneuvering space, and the type of activity that the apron serves. The ideal apron size affords the maximum parking capacity with a minimum amount of paving.

**9-8.2 Types of Aprons and Other Pavements.**

Listed here are types of aprons and other aviation facilities:

- Parking Apron (RQ-1/4)
- Hangar access apron/Warm up pad (MQ-1/9, RQ-7Bv2)
- Arm/Dearm pad

**9-8.3 RQ-4A/B Global Hawk Parking Apron.**

Parking areas for the RQ-4A Global Hawk and the RQ-4B Global Hawk should be designed with dimensions shown in Figure 9-8. Locations for tie-downs on the RQ-4A are shown in Figure 9-7. Tie-downs should be designed to resist an uplift force equal to the rated capacity of the tie down chain (i.e., typically 44,482N [10,000 pounds]). Special apron areas for hot refueling or arming/dearming are not required for the Global Hawk.

**9-8.3.1 Location.**

Aprons should be located contiguous to maintenance and hangar facilities. Do not locate them within runway and taxiway lateral clearance distances. A typical access apron is illustrated in Figure 9-9 (For US Army based on Vice Chief of Staff of the Army (VCSA) approval of concept, there is no aircraft parking apron authorized for UAS.)

**9-8.3.2 Size.**

As a general rule, there are no standard sizes for aircraft aprons. Aprons are individually designed to support aircraft and missions at specific facilities. The actual dimensions of an apron are based on the number of authorized aircraft, the maneuvering space, and the type of activity that the apron serves. The ideal apron size affords the maximum parking capacity with a minimum amount of paving.

**9-8.4 Hangar Access Apron.**

The pavement that allows access from the taxiway/towway to the hangar is referred to as a “hangar access apron” and is discussed in more detail below based on Army usage.

**9-8.4.1 MQ-1C.**

For USA the MQ-1C parking space width is 19.81m [65’], and the parking space length is 12.19m [40’].

**9-8.4.2 Specific Aircraft.**

If the assigned aircraft are predominantly one type, the access apron will be based on the specific dimensions of that aircraft, i.e. an RQ-7Bv2 parking space is 9.45m [31’] in width and 6.71m [22’] in length.

**9-8.4.3 Layout.**

The hangar access/ parking apron will be sized to accommodate a minimum of two UAS’s with an area for one UAS to be towed by.

**Table 9-9. UAS Hangar Access Apron**

Table 9-9. UAS Hangar Access Apron				
Item		MQ-1/9	RQ-7A/B	Remarks
No.	Description	Requirement		
1	Length (ft)	60.96m [200’]	4.57m [15’]	For Army MQ-1 hangars the standard length is 30.48m [100’].
Access aprons are located between the taxiway/towway and the front of the hangar. The hangar cannot be located within the taxiway/towway clearance distance.				

Table 9-9. UAS Hangar Access Apron				
Item		MQ-1/9	RQ-7A/B	Remarks
No.	Description	Requirement		
2	Width (ft)	121.92m [400']	9.75m [32']	Pavement should be sized for type of aircraft, number of hangar bays, and location of hangar bays. For Army MQ-1 hangars, the standard width is 48.77m [160'].
3	Grades in direction of drainage	Min +0.5% Max +1.5%		NFPA 415 requires aircraft fueling ramps to slope away from terminal buildings, aircraft hangars, aircraft loading walkways, or other structures.
		Min -1.0% first 15.24m [50'] from hangar		
4	Width of shoulders (total width including paved and unpaved) (ft)	3.05m [10']	1.52m [5']	For unpaved shoulders turfed/grassed shoulders are recommended except in desert locations where gravel surfacing is also acceptable.
5	Width of paved shoulders	Not required		
6	Transverse grade of unpaved shoulder	(a) 40mm [1.5"] drop-off at edge of pavement. (b) 2.0% min, 4.0% max.		
7	Wingtip clearance to fixed or mobile obstacles (ft)	7.62m [25']	3.05m [10'] with wing walkers	Along length of access apron. Wingtip clearance at entrance to hangar may be reduced to 3.05m [10'] either side of the door for RQ-4, MQ-1/9, 1.52m [5'] either side for RQ-7.
8	Grade (area between access apron shoulder and wingtip clearance line)	Max 10.0%		If the wingtip clearance line falls within the access apron shoulder, no grading is required beyond the access apron shoulder.

## 9-9 MOORING AND GROUNDING POINTS.

### 9-9.1 Layout.

The mooring points are located five feet fore and aft or left and right of the grounding point.

- Mooring point Layout for RQ-1/4 USAF/USN. See Figure 9-7.
- Mooring point Layout for UAS hangar access apron. See Figure 9-9.

- See Appendix B, Section 11 for typical mooring point details and testing procedures.

Figure 9-7. Mooring Layout for the RQ-4A Global Hawk

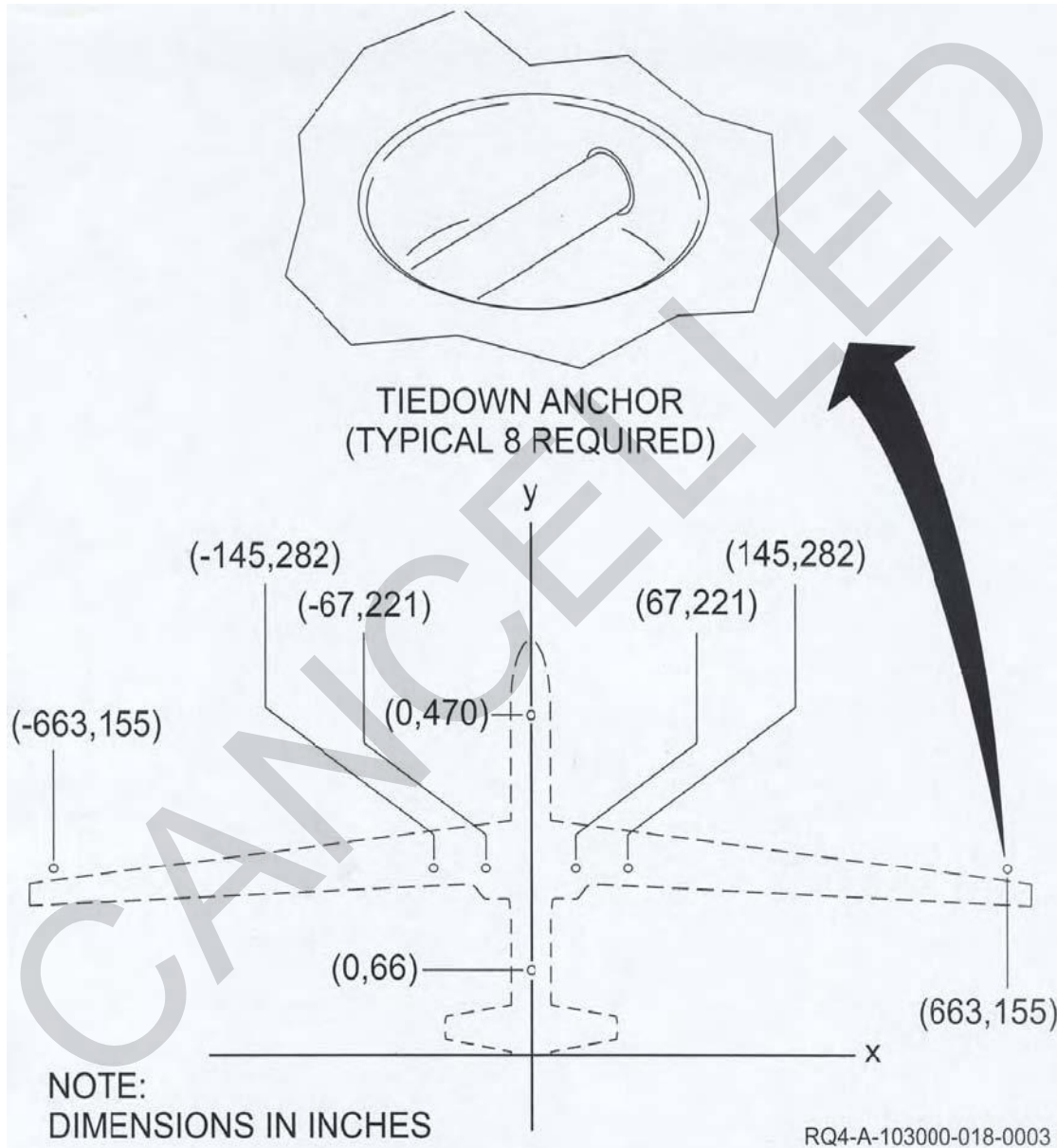

Figure 9-8. Parking Area Dimensions for RQ-4A and RQ-4B Global Hawk

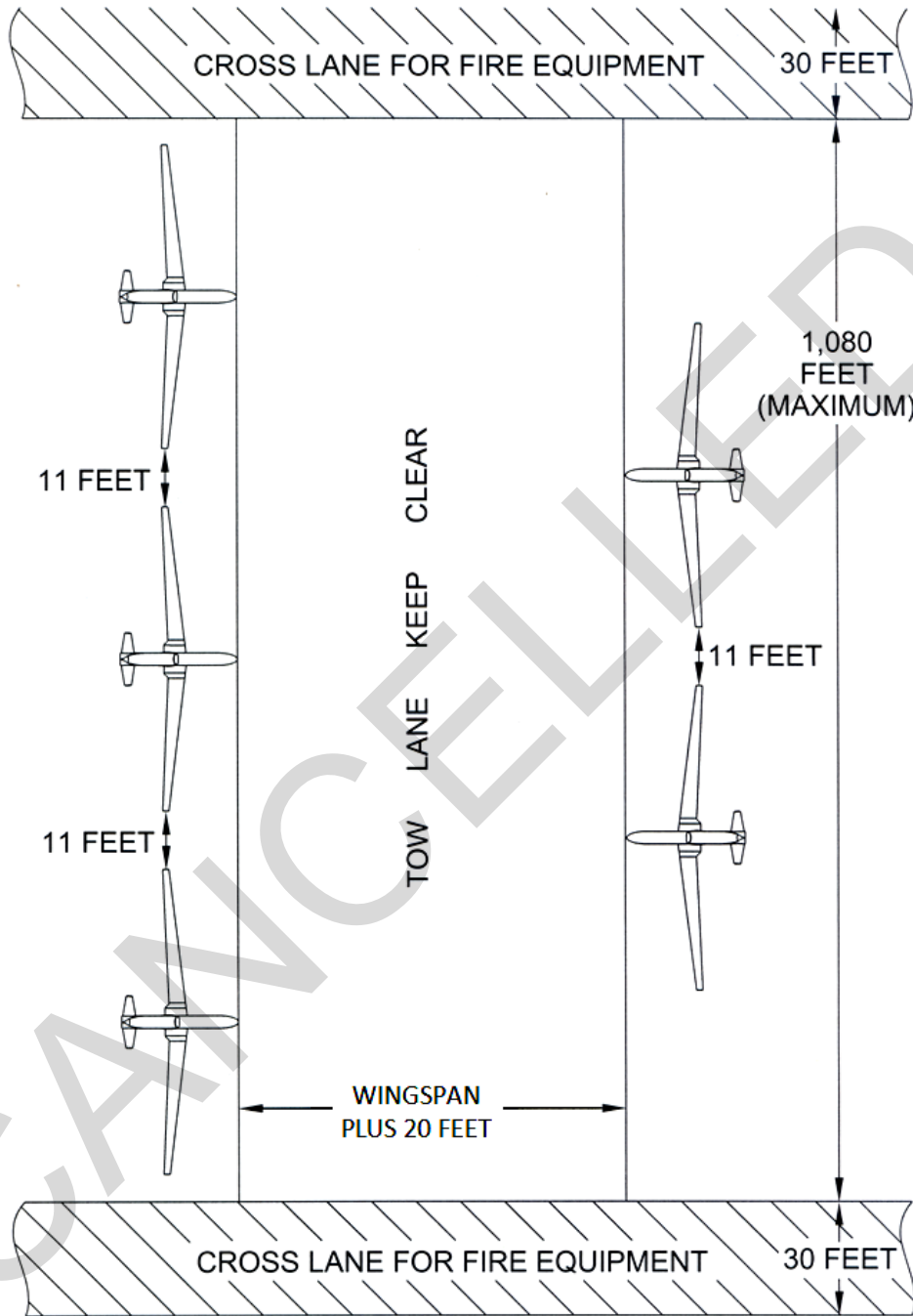

Figure 9-9. Standard Army MQ-1C Hangar Access Apron

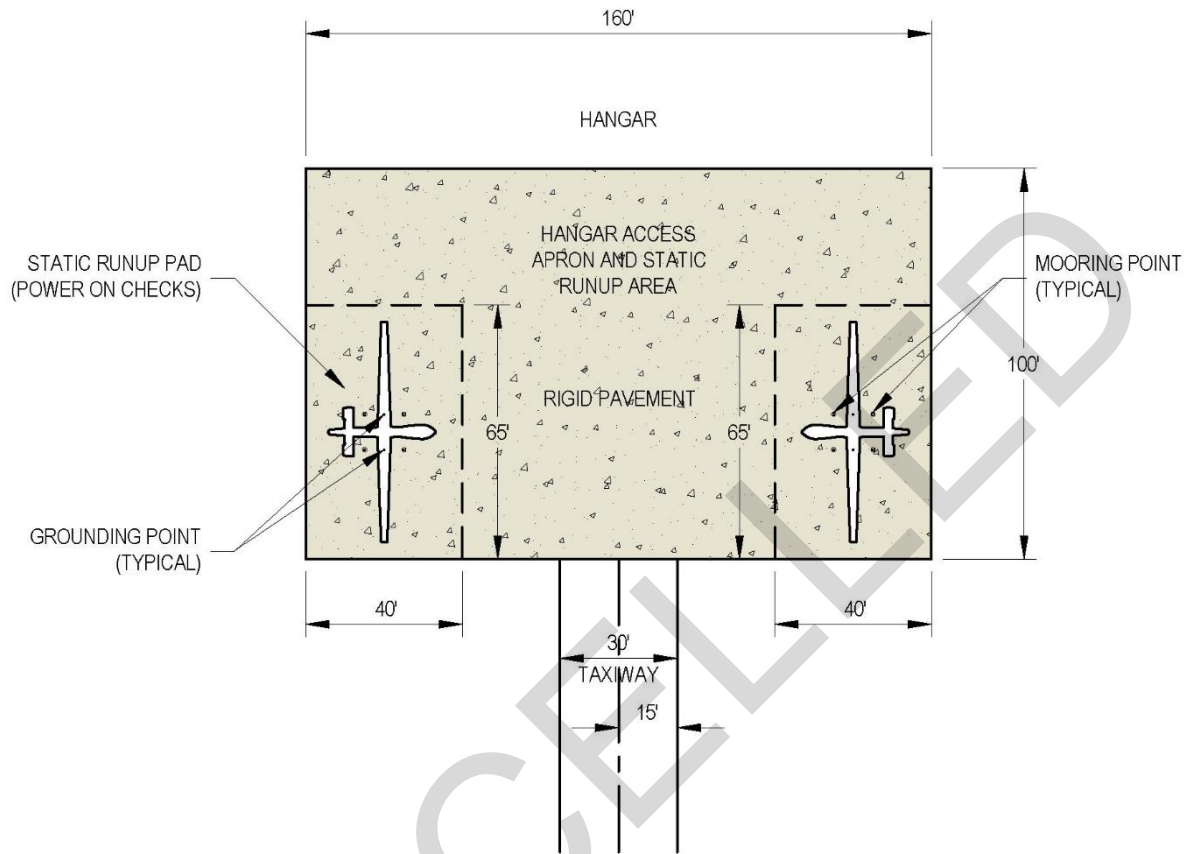
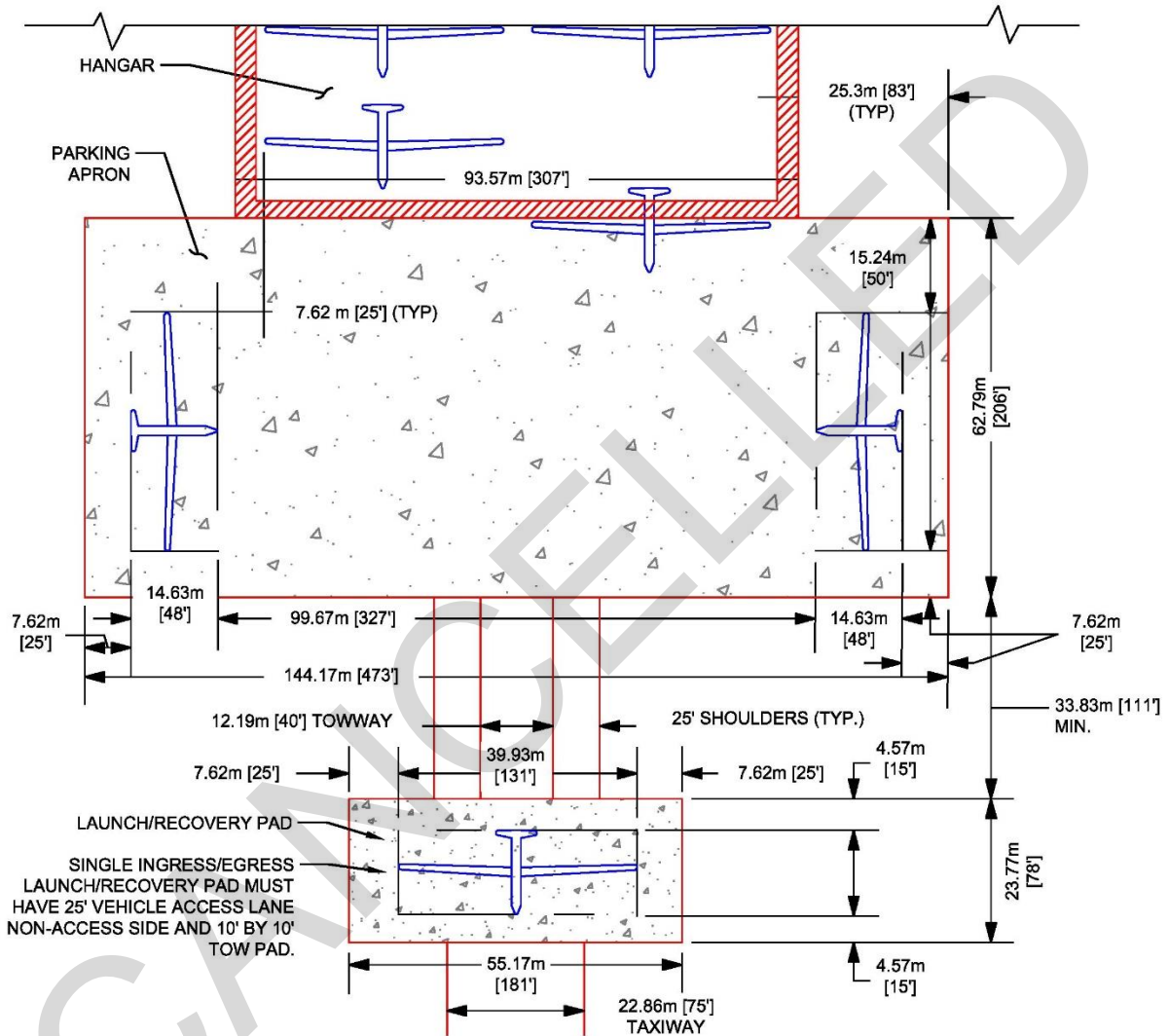

Figure 9-10. Navy MQ-4C Triton Hangar Access Apron

**Note:** The Triton unmanned aircraft system (UAS) requires a dedicated launch location to allow the Global Positioning System codes to be incorporated into the aircraft's mission plan for airfield ground taxi operations. The aircraft will utilize the UAS launch point for all programmed start and stop airfield operations. UAS dedicated aprons do not require peripheral taxiways.



**NOTES:**

1. THIS IS A BASIC APRON LAYOUT AND MAY BE SITE ADAPTED TO MEET ADDITIONAL CUSTOMER REQUIREMENTS.
2. LAYOUT OF PARKING APRON AND LAUNCH/RECOVERY PAD ALLOWS FOR SIMULTANEOUS OPERATIONS. AN OFFSET OF 111' IS REQUIRED.
3. AN OFFSET OF 25' IS REQUIRED BETWEEN PAVEMENT EDGE AND WINGTIP CLEARANCES FOR MAINTENANCE AND SAFETY.
4. WINGTIP CLEARANCE RADII ARE BASED ON A 45 DEGREE TURN.



**9-10 LIGHTING.**

Lighting will be IAW UFC 3-535-01.

**9-11 MARKING.**

Markings will be IAW UFC 3-260-04.

CANCELLED

THIS PAGE INTENTIONALLY BLANK

CANCELLED

## APPENDIX A REFERENCES

- AFH 32-1084, *Facility Requirements Handbook*, Department of the Air Force, <http://www.e-publishing.af.mil/>
- AFH 32-7084, *AICUZ Program Manager's Guide*, Department of the Air Force, <http://www.e-publishing.af.mil/>
- AFI 11-218, *Aircraft Operations and Movement on the Ground*, Department of the Air Force, <http://www.e-publishing.af.mil/>
- AFI 11-230, *Instrument Procedures*, Department of the Air Force, <http://www.e-publishing.af.mil/>
- AFI 13-203, *Air Traffic Control*, Department of the Air Force, <http://www.e-publishing.af.mil/>
- AFI 13-213, *Airfield Management*, Department of the Air Force, <http://www.e-publishing.af.mil/>
- AFI 13-217, *Drop Zone and Landing Zone Operations*, Department of the Air Force, <http://www.e-publishing.af.mil/>
- AFI 31-101, *The Air Force Installation Security Program (FOUO)*, Department of the Air Force, <http://www.e-publishing.af.mil/>
- AFI 32-1024, *Standard Facility Requirements*, Department of the Air Force, <http://www.e-publishing.af.mil/>
- AFI 32-1042, *Standards for Marking Airfields*, Department of the Air Force, <http://www.e-publishing.af.mil/>
- AFI 32-1043, *Managing, Operating, and Maintaining Aircraft Arresting Systems*, Department of the Air Force, <http://www.e-publishing.af.mil/>

AFI 32-1044, *Visual Air Navigation Systems*, Department of the Air Force, <http://www.e-publishing.af.mil/>

AFI 32-1065, *Grounding Systems*, Department of the Air Force, <http://www.e-publishing.af.mil/>

AFI 32-7062, *Air Force Comprehensive Planning*, Department of the Air Force, <http://www.e-publishing.af.mil/>

AFI 32-7063, *Air Installation Compatible Use Zone Program*, Department of the Air Force, <http://www.e-publishing.af.mil/>

AFI 91-208, *Hazards of Electromagnetic Radiation to Ordnance (HERO) Certification and Management*, Department of the Air Force, <http://www.e-publishing.af.mil/>

AFMAN 91-201, *Explosives Safety Standards*, Department of the Air Force, <http://www.e-publishing.af.mil/>

Air Force Typical Installation Drawing 67F2013, BAK-12 Typical Installation Drawings, Department of the Air Force, [https://cs2.eis.af.mil/sites/10159/SitePages/Service%20Page.aspx?Service=Aircraft%20Arresting%20Systems%20\(AAS\)](https://cs2.eis.af.mil/sites/10159/SitePages/Service%20Page.aspx?Service=Aircraft%20Arresting%20Systems%20(AAS))

AR 95-2, *Air Traffic Control, Airfield/Heliport, and Airspace Operations*, Department of the Army, <https://armypubs.army.mil/>

AR 190-16, *Physical Security*, Department of the Army, <https://armypubs.army.mil/>

AR 200-1, *Environmental Protection and Enhancement*, Department of the Army, <https://armypubs.army.mil/>

AR 210-20, *Real Property Master Planning for Army Installations*, Department of the Army, <https://armypubs.army.mil/>

AR 385-10, *The Army Safety Program*, Department of the Army, <https://armypubs.army.mil/>

CFR Title 14, Part 77, *Objects Affecting Navigable Airspace*,  
<http://www.gpoaccess.gov/cfr/index.html>

DAPAM 385-64, *Ammunition and Explosives Safety Standards*, Department of the Army, <https://armypubs.army.mil/>

DoD Instruction 4165.57, *Air Installations Compatible Use Zones*,  
<http://www.dtic.mil/whs/directives/corres/html/416557.htm>

DoD 6055.09-M, *Ammunition and Explosives Safety Standards*,  
<http://www.dtic.mil/whs/directives/corres/html/605509std.htm>

FAA AC 70/7460-1, *Obstruction Marking and Lighting*, Federal Aviation Administration,  
[https://www.faa.gov/airports/resources/advisory\\_circulars/](https://www.faa.gov/airports/resources/advisory_circulars/)

FAA AC 90-23, *Aircraft Wake Turbulence*, Federal Aviation Administration,  
[https://www.faa.gov/airports/resources/advisory\\_circulars/](https://www.faa.gov/airports/resources/advisory_circulars/)

FAA AC 97-1, *Runway Visual Range (RVR)*, Federal Aviation Administration,  
[https://www.faa.gov/airports/resources/advisory\\_circulars/](https://www.faa.gov/airports/resources/advisory_circulars/)

FAA AC 150/5060-5, *Airport Capacity and Delay*, Federal Aviation Administration,  
[https://www.faa.gov/airports/resources/advisory\\_circulars/](https://www.faa.gov/airports/resources/advisory_circulars/)

FAA AC 150/5210-5, *Painting, Marking, and Lighting of Vehicles Used on an Airport*,  
Federal Aviation Administration,  
[https://www.faa.gov/airports/resources/advisory\\_circulars/](https://www.faa.gov/airports/resources/advisory_circulars/)

FAA AC 150/5220-13, *Runway Surface Condition Sensor Specification Guide*, Federal Aviation Administration,  
[https://www.faa.gov/airports/resources/advisory\\_circulars/](https://www.faa.gov/airports/resources/advisory_circulars/)

FAA AC 150/5220-16, *Automated Weather Observing Systems (AWOS) for Non-Federal Applications*, Federal Aviation Administration,  
[https://www.faa.gov/airports/resources/advisory\\_circulars/](https://www.faa.gov/airports/resources/advisory_circulars/)

FAA AC 150/5220-9, *Aircraft Arresting Systems for Joint Civil/Military Airports*, Federal Aviation Administration, [https://www.faa.gov/airports/resources/advisory\\_circulars/](https://www.faa.gov/airports/resources/advisory_circulars/)

FAA AC 150/5300-13, *Airport Design*, Federal Aviation Administration, [https://www.faa.gov/airports/resources/advisory\\_circulars/](https://www.faa.gov/airports/resources/advisory_circulars/)

FAA AC 150/5340-18, *Standards for Airport Sign Systems*, Federal Aviation Administration, [https://www.faa.gov/airports/resources/advisory\\_circulars/](https://www.faa.gov/airports/resources/advisory_circulars/)

FAA AC 150/5340-30, *Design and Installation Details for Airport Visual Aids*, Federal Aviation Administration, [https://www.faa.gov/airports/resources/advisory\\_circulars/](https://www.faa.gov/airports/resources/advisory_circulars/)

FAA AC 150/5345-12, *Specification for Airport and Heliport Beacons*, Federal Aviation Administration, [https://www.faa.gov/airports/resources/advisory\\_circulars/](https://www.faa.gov/airports/resources/advisory_circulars/)

FAA AC 150/5345-27, *FAA Specification for Wind Cone Assemblies*, Federal Aviation Administration, [https://www.faa.gov/airports/resources/advisory\\_circulars/](https://www.faa.gov/airports/resources/advisory_circulars/)

FAA AC 150/5345-28, *Precision Approach Path Indicator (PAPI) Systems*, Federal Aviation Administration, [https://www.faa.gov/airports/resources/advisory\\_circulars/](https://www.faa.gov/airports/resources/advisory_circulars/)

FAA AC 150/5345-43, *Specification for Obstruction Lighting Equipment*, Federal Aviation Administration, [https://www.faa.gov/airports/resources/advisory\\_circulars/](https://www.faa.gov/airports/resources/advisory_circulars/)

FAA AC 150/5345-44, *Specification for Runway and Taxiway Signs*, Federal Aviation Administration, [https://www.faa.gov/airports/resources/advisory\\_circulars/](https://www.faa.gov/airports/resources/advisory_circulars/)

FAA AC 150/5345-46, *Specification for Runway and Taxiway Light Fixtures*, Federal Aviation Administration, [https://www.faa.gov/airports/resources/advisory\\_circulars/](https://www.faa.gov/airports/resources/advisory_circulars/)

FAA AC 150/5370-2, *Operational Safety on Airports during Construction*, Federal Aviation Administration, [https://www.faa.gov/airports/resources/advisory\\_circulars/](https://www.faa.gov/airports/resources/advisory_circulars/)

FAA AC 150/5390-2, *Heliport Design*, Federal Aviation Administration, [https://www.faa.gov/airports/resources/advisory\\_circulars/](https://www.faa.gov/airports/resources/advisory_circulars/)

FAA Form 7460-1, *Notice of Proposed Construction or Alteration*, Federal Aviation Administration, <https://www.faa.gov/airports/resources/forms/>

FAA Form 7460-2, *Notice of Actual Construction or Alteration*, Federal Aviation Administration, <https://www.faa.gov/airports/resources/forms/>

FAA Form 7480-1, *Notice of Landing Area Proposal*, Federal Aviation Administration, <https://www.faa.gov/airports/resources/forms/>

FAA Order 6310.6, *Primary/Secondary Terminal Radar Siting Handbook*, Federal Aviation Administration, <https://www.faa.gov/airports/resources/publications/orders/>

FAA Order 6480.4, *Airport Traffic Control Tower Siting Criteria*, Federal Aviation Administration, <https://www.faa.gov/airports/resources/publications/orders/>

FAA Order 6560.20, *Siting Criteria for Automated Weather Observing Systems (AWOS)*, Federal Aviation Administration, <https://www.faa.gov/airports/resources/publications/orders/>

FAA Order 6750.16, *Siting Criteria for Instrument Landing Systems*, Federal Aviation Administration, <https://www.faa.gov/airports/resources/publications/orders/>

FAA Order 6820.10, *VOR, VOR/DME and VORTAC Siting Criteria*, Federal Aviation Administration, <https://www.faa.gov/airports/resources/publications/orders/>

FAA Order 6830.5, *Criteria for Siting Microwave Landing Systems*, Federal Aviation Administration, <https://www.faa.gov/airports/resources/publications/orders/>

FAA Order 6850.8, *Medium-Intensity Approach Lighting System with Runway Alignment Indicator Lights (MALSR)*, Federal Aviation Administration, <https://www.faa.gov/airports/resources/publications/orders/>

FAA Order 6850.11, *Medium-Intensity Approach Lighting System with Runway Alignment Indicator Lights (MALSR)*, 27 August 1975, Federal Aviation Administration, <https://www.faa.gov/airports/resources/publications/orders/>

FAA Order 6850.2, *Visual Guidance Lighting Systems*, Federal Aviation Administration, <https://www.faa.gov/airports/resources/publications/orders/>

FAA Order 6850.21, *Omnidirectional Approach Lighting System (ODALS)*, Federal Aviation Administration, <https://www.faa.gov/airports/resources/publications/orders/>

FAA Order 6850.24, *Runway End Identifier Lighting System*, Federal Aviation Administration, <https://www.faa.gov/airports/resources/publications/orders/>

FAA Order 6850.28, *Precision Approach Path Indicator (PAPI) Project Implementation Plan*, Federal Aviation Administration, <https://www.faa.gov/airports/resources/publications/orders/>

FAA Order 7031.2, *Airway Planning Standard Number One Terminal Air Navigation Facilities and ATC Services*, Federal Aviation Administration, <https://www.faa.gov/airports/resources/publications/orders/>

FAA Order 7110.65, *Air Traffic Control*, Federal Aviation Administration, <https://www.faa.gov/airports/resources/publications/orders/>

FAA Order 7400.2, *Procedures for Handling Airspace Matters*, Federal Aviation Administration, <https://www.faa.gov/airports/resources/publications/orders/>

FAA Order 8260.15, *United States Army Terminal Instrument Procedure Service*, <https://www.faa.gov/airports/resources/publications/orders/>

FAA Order 8260.38, *Civil Utilization of Global Positioning System (GPS)*, Federal Aviation Administration, <https://www.faa.gov/airports/resources/publications/orders/>

FAR Part 77, *Objects Affecting Navigable Air Space*, [http://www.ecfr.gov/cgi-bin/text-idx?sid=f14537421ebc6dce46144a851197c5ee&c=ecfr&tpl=/ecfrbrowse/Title14/14tab\\_02.tpl](http://www.ecfr.gov/cgi-bin/text-idx?sid=f14537421ebc6dce46144a851197c5ee&c=ecfr&tpl=/ecfrbrowse/Title14/14tab_02.tpl)

ICAO Document 9157, *Aerodrome Design Manual*, International Civil Aviation Organization, <http://www.icao.int/>



IEEE Standard 142, *Recommended Practice for Grounding of Industrial and Commercial Power Systems*, Institute of Electrical and Electronic Engineers, <http://www.ieee.org/web/standards/home/index.html>

IESNA Lighting Handbook, Illuminating Engineering Society of North America , <http://www.iesna.org/>

MTMC Pamphlet 55-14, *Traffic Engineering for Better Signs and Markings*, Army Military Traffic Management Command, [http://www.tea.army.mil/pubs/nr/dod/pmd/PAM\\_55-14.htm](http://www.tea.army.mil/pubs/nr/dod/pmd/PAM_55-14.htm)

MUTCD, *Manual on Uniform Traffic Control Devices*, Current Edition, Federal Highway Administration, <http://mutcd.fhwa.dot.gov/>

NAVAIR 16-1-529, *Electromagnetic Radiation Hazards*, Department of the Navy

NAVAIR 51-50AAA-2, *General Requirements for Shore Based Airfield Marking and Lighting*, Department of the Navy

NAVFACINST 11010.45A, *Site Approval Request Process*, Naval Facilities Engineering Command

NEPA (National Environmental Policy Act) of 1969, <http://www.nepa.gov/nepa/regs/nepa/nepaeqia.htm>

NFPA Standard 415, *Standard on Airport Terminal Buildings, Fueling Ramp Drainage, and Loading Walkways*, National Fire Protection Association, <http://www.nfpa.org>

OPNAVINST 5090.1B (MCO 5090.2), *Environmental and Natural Resources Program Manual*, Department of the Navy

OPNAVINST 11010.36C/MCO 11010.16 (or latest version), *Air Installations Compatible Use Zones (AICUZ) Program*, Department of the Navy

- T.O. 00-25-172, *Ground Servicing of Aircraft and Static Grounding/Bonding*, Department of the Air Force
- T.O. 31P5-2GPN22-12, *Radar Set Group, Type AN/GPN-22(V) PN 743000-4*, Department of the Air Force
- T.O. 31Z-10-19, *Air Traffic Control, C-E Facility and System Engineering Standards*, Department of the Air Force
- T.O. 31Z3-822-2, *Air Traffic Control and Landing Systems (ATCALs) General Site Requirements*, Department of the Air Force
- T.O. 36-1-191, *Technical and Managerial Reference for Motor Vehicle Maintenance*, Department of the Air Force
- TM 1-1500-250-23, *General Tie-Down and Mooring on all Series Army Models AH-64, UH-60, CH-47, UH-1, AH-1, OH-58 Helicopters*, Department of the Army, <https://www.logsa.army.mil/etmpdf/files/040000/045000/045826.pdf>
- TM 5-811-5, *Army Aviation Lighting*, U.S. Army Corps of Engineers, <http://www.usace.army.mil/publications/armytm/>
- UFC 2-000-05N, *Facility Planning for Navy and Marine Corps Shore Installations*, <http://www.wbdg.org/ffc/dod/unified-facilities-criteria-ufc>
- UFC 3-240-01, *Wastewater Collection*, Naval Facilities Engineering Command, <http://www.wbdg.org/ffc/dod/unified-facilities-criteria-ufc>
- UFC 3-240-13FN, *Industrial Water Treatment Operation and Maintenance*, Naval Facilities Engineering Command, <http://www.wbdg.org/ffc/dod/unified-facilities-criteria-ufc>
- UFC 3-260-02, *Pavement Design for Airfields*, U.S. Army Corps of Engineers, <http://www.wbdg.org/ffc/dod/unified-facilities-criteria-ufc>

- UFC 3-260-04, *Airfield and Heliport Marking*, Air Force Civil Engineer Center, <http://www.wbdg.org/ffc/dod/unified-facilities-criteria-ufc>
- UFC 3-440-01, *Facility-Scale Renewable Energy Systems*, Naval Facilities Engineering Command, <http://www.wbdg.org/ffc/dod/unified-facilities-criteria-ufc>
- UFC 3-460-01, *Petroleum Fuel Facilities*, Naval Facilities Engineering Command, <http://www.wbdg.org/ffc/dod/unified-facilities-criteria-ufc>
- UFC 3-535-01, *Visual Air Navigation Facilities*, Air Force Civil Engineer Center, <http://www.wbdg.org/ffc/dod/unified-facilities-criteria-ufc>
- UFC 3-535-02, *Design Drawings for Visual Air Navigation Facilities (Draft)*, Department of the Air Force, <http://www.wbdg.org/ffc/dod/unified-facilities-criteria-ufc>
- UFC 3-540-08, *Utility-Scale Renewable Energy Systems*, Air Force Civil Engineer Center, <http://www.wbdg.org/ffc/dod/unified-facilities-criteria-ufc>
- UFC 3-575-01, *Lightning and Static Electricity Protection Systems*, U.S. Army Corps of Engineers, <http://www.wbdg.org/ffc/dod/unified-facilities-criteria-ufc>
- UFC 3-600-01, *Fire Protection Engineering for Facilities*, Naval Facilities Engineering Command, <http://www.wbdg.org/ffc/dod/unified-facilities-criteria-ufc>
- UFC 4-020-01, *DoD Security Engineering Facilities Planning Manual*, U.S. Army Corps of Engineers, <http://www.wbdg.org/ffc/dod/unified-facilities-criteria-ufc>
- UFC 4-133-01, *Air Traffic Control and Air Operations Facilities*, Naval Facilities Engineering Command, Naval Facilities Engineering Command,, <http://www.wbdg.org/ffc/dod/unified-facilities-criteria-ufc>
- UFC 4-211-01, *Aircraft Maintenance Hangars: Type I and Type II*, Naval Facilities Engineering Command, <http://www.wbdg.org/ffc/dod/unified-facilities-criteria-ufc>
- UFC 4-211-02, *Aircraft Corrosion Control and Paint Facilities*, Naval Facilities Engineering Command, <http://www.wbdg.org/ffc/dod/unified-facilities-criteria-ufc>

UFC 4-832-01N, Design: Industrial and Oily Wastewater Control, Naval Facilities Engineering Command, <http://www.wbdg.org/ffc/dod/unified-facilities-criteria-ufc>

USACE TSC Report 13-2, *Aircraft Characteristics for Military Aircraft*, U.S. Army Corps of Engineers, <https://transportation.wes.army.mil/tsmcx/criteria.aspx>

USACE TSC Report 13-3, *Aircraft Characteristics for Selective Commercial Aircraft*, U.S. Army Corps of Engineers, <https://transportation.wes.army.mil/tsmcx/criteria.aspx>

USAFEI 32-1007, *Airfield and Heliport Planning and Design*, U.S. Air Forces in Europe, <http://www.e-publishing.af.mil/>

CANCELLED

**APPENDIX B  
SECTION 1  
WAIVER PROCESSING PROCEDURES**

**B1-1 ARMY.**

**B1-1.1 Waivers to Criteria and Standards.**

Waivers are processed when compliance with criteria cannot be achieved, the obstruction poses little or no risk to flying safety, and there are no other alternatives. When proposed objects or facilities will violate airfield imaginary surfaces, safe clearance, or other design criteria established in this manual, they must be analyzed to determine potential impact and risks to aircraft operations, personnel, and infrastructure.

**B1-1.1.1 Permanent Waivers.**

Established for violations that cannot be reasonably corrected and either pose little to no threat to flight operations and personnel or risks have been accepted at the appropriate level. Permanent waivers are issued where no further mitigative actions are intended or necessary.

**B1-1.1.2 Temporary Waivers.**

Established for a specified period during which additional actions to mitigate the situation must be initiated to fully comply with criteria or to obtain a permanent waiver. Routine follow-up inspections are required to evaluate the effectiveness of implemented risk mitigation actions, control measures, and identification of new risks for each temporary waiver granted.

**B1-1.1.3 Operational Waivers.**

Establish operational waivers when a particular aircraft operation is required to operate on existing facilities that do not meet current airfield design criteria listed in this manual. Ensure a risk assessment is performed on all proposed operational waiver requests prior to submitting to the approval authority. All operational waiver requests must have the aviation mission commander's endorsement.

**B1-1.1.4 Construction Waivers.**

A construction waiver (sometimes referred to as temporary construction waivers) is obtained when one or more elements of a construction project (equipment, facilities, personnel, etc.) violate airfield and airspace criteria in this manual. Construction waivers should only be planned for the duration of the construction project unless circumstances dictate otherwise. An FAA Form 7460-1 Notice of Proposed Construction or Alteration, must be submitted to the DAR prior to sending the request to the Installation/Garrison commander for approval. Temporary waiver requests for construction projects must be prepared in accordance with paragraphs B1-1.1 and B1-1.2.

NOTE: Emergency maintenance and repair requirements and routine maintenance activities, such as mowing and maintenance of airfield systems, are exempt from this requirement; however, the DPW Airfield Manager will ensure implementation of appropriate safety measures, including Notices to Airmen (NOTAM) or Local NOTAMs.

**B1-1.1.5 Permissible Deviations.**

Permissible deviations to airfield and airspace criteria which do not require waivers if properly sited are listed in Section 13 of this appendix, beginning at paragraph B13-2.

**B1-1.1.6 Exemptions.**

Existing airfield facilities (See paragraph 1-3.1) built under previous design standards should be documented as exemptions and programmed for replacement away from the airfield environment at the end of their useful life or when mission needs dictate earlier replacement. If improvements are proposed that would extend the useful life of the airfield facilities, a temporary/permanent waiver must be requested. If the exempted facility is demolished, any use of that site should conform to the criteria in this UFC.

Airfield managers will identify and document all airfield facilities built under previous design standards and not requiring a waiver and submit the following information to the ACOM/ASCC/DRU or ARNG for validation:

- Description of exempt facility. (e.g. fixed-wing runway lacks overruns, taxiway lacks shoulders).
- Pictures, diagrams or charts that clearly illustrate the current exempt condition.
- Original mission supported (e.g. runway designed for Air Force B-52, taxiways designed for rotary-wing aircraft, etc.) and current mission supported.
- Year built. (Supporting documentation that confirms when the facility was built or a previous determination was made).
- Previous design criteria used (regulation number, criteria and date if known).
- Current criteria required and description of violation. (e.g., Table 3-2., runway lateral clearance zone, 500 ft. requirement, Taxiway B is 400 ft. from centerline/100 ft. violation).
- Safety of operations (risk management). Use DD Form 2977 Deliberate Risk Assessment Worksheet. Include risk description of each risk level associated with the non-compliant condition and what mitigation actions will be taken. See DA PAM 385-30 and ATP 5-19 for guidance.
- Estimated cost to remove/relocate or correct condition.

The ACOM/ASCC/DRU or ARNG will determine whether documented facilities should be classified as an exemption, or should have a temporary or permanent waiver.

**B1-1.2 Responsibilities.**

**B1-1.2.1 Installation.**

The installation's design agent, aviation representative (safety officer, Airfield Manager, operations officer, and/or air traffic and airspace [AT&A] officer), Department of Public Works (DPW) and/or Construction Facilities Management Office (CFMO) master planner will:

- Jointly with DPW prepare/initiate all waiver requests. Project Designers must immediately notify the Airfield Manager when project designs will not meet design criteria listed in this manual.
- Submit requests through the installation to the ACOM/ASCC/DRU/or ARNG.
- Maintain a complete record of all waivers requested and their disposition (approved or disapproved). A list of waivers to be requested and those approved for a project should also be included in the project design analysis prepared by the design agent, aviation/airfield representative, or DPW/CFMO master planner.
- Annual review. All airfield waivers will be annually reviewed to validate if a requirement for the waiver still exists, and all appropriate safety precautions, mitigative measures, and conditions of approval are being effectively implemented. Waivers no longer required will be cancelled through the ACOM/ASCC/DRU/ or ARNG.

**B1-1.2.2 The ACOM/ASCC/DRU or ARNG will:**

- Ensure all required coordination has been accomplished.
- Ensure the type of waiver requested is clearly identified as either temporary or permanent.
- Review all command supported waiver requests and forward to USAASA for action.
- Provide a command level endorsement of the waiver request.

**B1-1.2.3 USAASA.**

USAASA is responsible for coordinating reviews for the waiver request with the following agencies:

- Air traffic control assessment by Air Traffic Services Command (ATSCOM).

- Safety and risk assessment by the U.S. Army Combat Readiness/Safety Center (USACRC).
- Technical engineering review by the Transportation Systems Center (TSC).
- Waivers that affect instrument flight procedures by the USAASA Instrument Procedures Branch.
- From these reviews, USAASA formulates a consolidated position and makes the final determination on all waiver requests.

**B1-1.3 Waiver Process Procedures.**

**B1-1.3.1 Contents of Waiver Requests.**

Each request must contain the following information:

- Reference by publication, paragraph, and page to the specific standard(s) and/or criterion to be waived. Include all applicable design criteria that is non-compliant.
- Complete justification for noncompliance with the airfield/airspace criteria and/or design standards. Demonstrate that noncompliance will provide an acceptable level of safety, economics, durability and quality for meeting the Army mission. This would include reference to special studies made to support the decision. For manmade obstacles, the date of construction needs to be stated/indicated. Specific justification for waivers to criteria and allowances must be included as follows:
  - a. When specific site conditions (physical and functional constraints) make compliance with existing criteria impractical and/or unsafe. For example, the need to provide hangar space for all aircraft because of recurring adverse weather conditions; the need to expand hangar space closer to and within the runway clearances due to lack of land; maintaining fixed-wing Class A clearances when support of Class B fixed-wing aircraft operations are over 10 percent of the airfield operations.
  - b. When deviation(s) from criteria fall within a reasonable margin of safety as determined by a documented risk assessment based on assigned and known future missions of airfield/heliport that are determined will not impair construction of long-range facility requirements. For example, locating security fencing around and within established clearance areas.
  - c. When construction that does not conform to criteria is the only alternative to meet mission requirements. Evidence of analysis and efforts taken to follow criteria and standards must be documented and referenced. Copies of this analysis will be included in the final designs and maintained by DPW real estate offices.



- The rationale for the waiver request, including specific impacts upon assigned mission, safety, and/or environment.
- Temporary waiver requests shall include the action planned to correct the violation, risk assessment, project/work order number, and estimated completion date.
- Safety of operations (risk management). Use DD Form 2977 Deliberate Risk Assessment Worksheet. Include risk description of each risk level associated with the non-compliant condition and what mitigation actions will be taken. See DA PAM 385-30 and ATP 5-19 for guidance.
- Pictures, diagrams, and charts that clearly illustrate condition, distances, etc.

### **B1-1.3.2 Additional Requirements.**

#### **B1-1.3.2.1 Operational Factors.**

Include information on the following existing and/or proposed operational factors used in the assessment:

- Mission urgency.
- All aircraft by type and operational characteristics.
- Density of aircraft operations at each air operational facility.
- Facility capability (visual flight rules [VFR] or instrument flight rules [IFR]).
- Use of self-powered parking versus manual parking.
- Existing navigational aids (NAVAID).

#### **B1-1.3.2.2 Documentation.**

Record all alternatives considered, their consequences, necessary mitigative efforts, and evidence of coordination. The Garrison/Installation Commander will sign all requests for waivers regardless of level of residual risk determined.

### **B1-2 AIR FORCE.**

#### **B1-2.1 Waivers to Criteria.**

##### **B1-2.1.1 Waivers, Permissible Deviations, Exemptions and Non-Conforming Facilities/Structures/Objects.**

Waivers are required when compliance with criteria cannot be achieved. The waiver process is designed to ensure leadership is aware of potential risk and to ensure that all alternatives have been considered. Approval of a waiver is an acknowledgment of the associated risk (it is not project approval). A thorough examination of potential alternatives must be completed and documented prior to installation site approval, and

before a waiver is requested from the MAJCOM/CD. When requesting a waiver, consider grouping adjacent supporting items with a controlling obstruction or grouping related items, such as a series of drainage structures, as one waiver. UFC 3-260-01 waivers do not apply to off installation development or obstructions to airspace off-installation (TERPS are the data steward for obstructions to air space criteria for off installation as outlined in AFI 32-7062). The only exception would be building a new airfield in an area with existing development (e.g. AFCENT, AFRICOM, EUCOM, PACOM). Under most circumstances, funding or budgetary constraints are not adequate justification for granting a waiver. Criteria violations caused by terrain located on Air Force controlled property will be classified as a non-conforming object, exemption or temporary waiver, not a permanent waiver. Criteria violations located on property not controlled by the Air Force will be classified as non-conforming facilities/structures or objects (see B1-2.1.8). There are four types of waivers (permanent, temporary, construction, and airshow) that are described below.

**NOTE:** Projects may be part of a larger NEPA action (in compliance with 32 CFR 989) which requires consideration of alternatives. The waiver request package should be provided in the environmental analysis.

**NOTE:** Clear Zones. Additionally, waivers to criteria in this UFC should be pursued for violations located within the graded area of the clear zone. A land use variance should be pursued if the proposal creates an incompatible land use violation in the remaining area of Air Force controlled clear zones, (See AFI 32-7063, Air Installations Compatibility Use Zone Program, AICUZ). In some circumstances, a proposal may require a waiver from this UFC and an AICUZ clear zone variance, if the proposal creates an incompatible land use, and violates criteria in this UFC (i.e. penetration into an imaginary surface).

**NOTE:** Operational Waivers. Certain existing facilities may require the supported aircraft activity to have an operational waiver in order to operate, such as taking off and landing on a shorter runway or inadequate wingtip clearance inside existing hangars and sunshades. These are operational waivers and not UFC 3-260-01 waivers. See AFI 11-218, Flying Operations, for additional information (This note applies to wing tip clearance in sunshades).

#### **B1-2.1.2 Permanent Waivers.**

Permanent waivers are established for criteria violations that cannot be reasonably met. If the criteria to be waived under this UFC would also result in a violation of UFC 3-535-01 Visual Air Navigation Facilities then consult with the Air Force Flight Standards Agency (AFFSA) and/or the Air Force Safety Center. The waiver request should be initiated by the Base Civil Engineer's (BCE) designated representative as soon as it is determined criteria can't be met, and be approved before siting, programming, and/or design is finalized. Permanent waivers are appropriate for violations associated with development of facilities on overseas installations where the U.S. has no authority to implement Air Force standards. See Section B1-2.2 for waiver package content. These waivers are approved/disapproved by the owning MAJCOM Deputy Commander.

Approval of a waiver constitutes acceptance of the risk associated with criteria violations. The MAJCOM/CD may delegate approval/disapproval authority to another organization within the MAJCOM Headquarters.

#### **B1-2.1.3 Temporary Waivers.**

Temporary waivers are established for criteria violations that can be corrected within eight years. During the two years following waiver approval, CE will develop/program an action to correct the violation, including a description of the proposed action, project number, and cost estimate. The remaining six years will be used to implement the corrective action. If the violation cannot be brought into compliance within eight years, the violation should be reclassified as a permanent waiver (Reclassification requests to permanent status will require MAJCOM/CD approval). See Section B1-2.2 for waiver package content. These waivers are approved/disapproved by the owning MAJCOM Deputy Commander. Approval of a waiver constitutes acceptance of the risk associated with criteria violations. The MAJCOM/CD may delegate approval/disapproval authority to another organization within the MAJCOM Headquarters.

#### **B1-2.1.4 Construction Waivers.**

A construction waiver (sometimes referred to as temporary construction waiver) is obtained when one or more elements of a construction project (equipment, facilities, personnel, etc.) violates criteria in this UFC. Construction waivers should only be planned for the duration of the construction project unless circumstances dictate otherwise. An FAA Form 7460-1 Notice of Proposed Construction or Alteration, must be included in request package to Installation Commander for approval. See Section 14 of this appendix, "Construction Phasing Plan and Operational Safety on Airfields during Construction" for additional guidance. Construction waivers should be approved before construction activities begin. The Installation Commander is the approval authority for construction waivers. See Section B1-2.2 for waiver package.

**NOTE:** Emergency maintenance and repair requirements, as well as routine maintenance activities (mowing, snow removal, rubber removal and maintenance of airfield systems), are exempt from this requirement; however, the BCE will coordinate with the airfield management, flight safety, and flight operations offices to ensure implementation of appropriate safety measures, including Notices to Airmen (NOTAM).

#### **B1-2.1.5 Air Show Waivers.**

Air Show waivers are processed for events that will temporarily create criteria violations. The Installation Commander is the approval authority for Air Show Waivers. See Section B1-2.2 for waiver package content. Event waivers other than airshows require MAJCOM/CD approval.

#### **B1-2.1.6 Permissible Deviations.**

Permissible deviations are for airfield support facilities or equipment that are not required to meet airfield criteria, however, they must meet siting criteria specified in Appendix B, Section 13, of this UFC. The MAJCOM Deputy Commander (MAJCOM/CD) may grant permissible deviation status for other airfield-related facilities or systems that are unique to the MAJCOM, but must provide acceptable construction standards, siting criteria, and aircraft clearance requirements for such items.

#### **B1-2.1.7 Exemptions.**

Facilities constructed under previous standards should be documented as exemptions and programmed for replacement away from the airfield environment at the end of their useful life or when mission needs dictate earlier replacement. If improvements are proposed that would extend the useful life of the facility, a waiver must be requested. If the exempted facility is demolished any use of that site should conform to the criteria in this UFC. Exception is allowed for facilities located beyond and beneath the Building Restriction Lines (BRL). These exempted facilities may remain without waiver for an indefinite period, and may be renovated to extend their life-cycle if the intended use of the facility fits within the approved category groups listed as appropriate for siting within the boundaries of the BRL. See Appendix B, Section 17 for guidelines provided to establish these areas and facilities approved for construction or renovation within this area.

#### **B1-2.1.8 Non-Conforming Facilities/Structures/Objects.**

Existing facilities, structures, or objects (which could include equipment or terrain features) identified as not meeting criteria in this UFC, and are not exempted or have an existing waiver, will be classified as Non-Conforming until they are evaluated to determine whether they should be classified as an exemption, or should have a permanent or temporary waiver. These may be identified during annual airfield inspections, special inspections, survey efforts, or while conducting day to day observations. The BCE will coordinate with airfield management, flight safety, and flight operations offices (and others as appropriate) to ensure implementation of appropriate safety measures.

#### **B1-2.1.9 Amendment of Waivers.**

Amendments to existing waivers (temporary and permanent) will be developed when there are proposed changes to the scope of the original violation. This may include increasing/decreasing criteria violations included in the original waiver request (e.g. lights, sunshades, improving grade, etc.). When the number/extent of criteria violations is reduced, note the improvement on the annual review. If the number/extent of criteria violations is increased, MAJCOM/CD approval is required

#### **B1-2.2 Contents of Waiver Request Package.**

Each request must contain the following information unless otherwise noted:

- Criteria to be waived. Reference publication, paragraph, and page number of the specific criteria to be waived.
- Alternatives Courses of Action (COA) Considered. Describe any alternative courses of actions that were considered when developing the solution proposal and why they were not acceptable for meeting the purpose and need of the proposal/action.
- Rationale/Justification of Selected COA. Explain the rationale for the selected COA and why the approving official should accept the risks associated with the proposal.
- Risk Assessment. Complete the AF Form 4437 Deliberate Risk Assessment Worksheet. Utilize a cross functional team to complete the risk assessment. Contributing organizations may include civil engineering, safety, airfield operations and others as appropriate. See AFI 90-802 for additional information. The risk analysis should include a detailed explanation of the methodology used, data considered, and rationale for determining the risk (see Attachment 8 of AFPAM 90-803).
- Graphics. Pictures, diagrams, and charts must clearly illustrate condition, distances, imaginary surfaces, clear zones, etc.
- Federal Aviation Administration (FAA) Notification. Include if required per Title 14, Code of Federal Regulations (CFR), Part 77.
- Proof of Coordination. The waiver preparer documents installation coordination from the appropriate stakeholders, for example: Safety, Operations Support, Maintenance, terminal instrument procedures (TERPS), Security Forces, Communications, Civil Engineering (and any other organizations that the installation feels should coordinate on the waiver request) before requesting approval from the installation commander. At the MAJCOM level, Temporary and Permanent waiver requests should be coordinated with the same functional offices as at installation level in addition to any additional offices deemed necessary.

**NOTE:** Ensure any packages to support reclassification of waivers will include all the information above.

### **B1-2.3 Processing Waiver Requests.**

Obtain current waiver processing procedures from AFCEC/CP. Waivers being reclassified will be accomplished through the standard waiver request process.

### **B1-2.4 Review of Waivers.**

Installation review of all approved Permanent and Temporary airfield waivers will be conducted by a cross functional team to include Operations, Safety, and other appropriate stakeholders. The results are to be briefed to the Facilities Board with a copy sent to AFCEC/CP. Include the following in the review:

- A list of all waivers by waiver number.
- Waiver currency, accuracy and classification evaluation (any proposed reclassification of a waiver identified in the review will be accomplished through the waiver approval process). Note the rationale for any proposed reclassification in the summary presentation to the Facilities Board.
- Evaluate the effectiveness of implemented risk mitigation actions, control measures, and identification of any new risks for each temporary waiver.
- A summary of the number of waivers approved and/or cancelled within the last year.
- An update of the status of action/projects associated with each temporary waiver.

**B1-2.5 Responsibilities.**

**B1-2.5.1 AFCEC/CO.**

Develops and maintains United Facilities Criteria for Airfield and Heliport Planning and design and provides secondary technical support on the airfield waiver program.

**B1-2.5.2 AFCEC/CP.**

Provides policy direction on the airfield waiver and waiver review programs. Determines technical sufficiency of permanent and temporary airfield waiver requests. Maintains completed airfield waivers and waiver reviews on its website. Forwards a record copy of installation waiver review summary to the MAJCOM for information.

**B1-2.5.3 HQ AFFSA.**

- Reviews all policy changes to airfield planning and design criteria before implementation to determine operational impact on airfield and aircraft operations.
- Reviews all requests for waivers to instrument procedure criteria.
- Processes requests for waivers to instrument procedure design criteria in accordance with guidance outlined in AFI 11-230.
- Provides documentation to AFCEC/CO to justify adding any new permissible deviations (such as newer navigational aids or weather equipment) in B13-2 Permissible Deviations. Documentation would include siting diagrams and signed Risk Assessment by AFFSA/CC or AFFSA/CD recommending the item and associated siting requirements be added to UFC 3-260-01 for the new permissible deviation.

**B1-2.5.4 Base Civil Engineer (BCE).**

- Coordinates with airfield management, flying and ground safety, flight operations, logistics, TERPS (typically at MAJCOM), security forces, and communications during waiver package preparation.
- **Establishes and updates (at least annually) geospatial data sets of approved waived items in accordance with AFI 32-7062, Comprehensive Planning, in conjunction with the latest published Installation Development Plan (IDP) GIS guidance. Also see AFI 11-230, Instrument Procedures.**
- Develops a military construction (MILCON) program or other project to systematically correct violations noted in temporary waivers. Project listing should include (by waiver) facilities board priority, facility investment metric (FIM) rating, integrated priority list (IPL) rating (or other installation or AFIMSC prioritization rating system), risk assessment rating, funds type required (e.g., O&M, MILCON, 3080), and projected fiscal year.
- Record, review, and process waiver requests (see paragraph B1-2.3 and B1-2.4) and maintain (for record) one copy of all pertinent documents relative to each waiver, including a record of staff coordination on actions at base, AFCEC/CP and MAJCOM levels.
- Lead the annual review of Permanent and Temporary waivers and brief the Facilities Board per paragraph B 1-2.4 above.
- Participates in an annual assessment of the airfield/airspace criteria using the Air Force Airfield Certification/Safety Inspection Checklist (see AFI 13-213).

**B1-2.5.5 NGB/A7CP (for ANG facilities).**

- Develops policy on waivers and manages the ANG waiver program.
- Processes and coordinates inquiries and actions for deviations to criteria and standards.
- ANG tenant units on active duty installations must use AFCEC/CP waiver processing guidelines.

**B1-2.5.6 HQ AFRC/A4C (for AFRC facilities).**

- Develops policy on waivers and manages the AFRC waiver program.
- Processes and coordinates inquiries and actions for deviations to criteria and standards.
- AFRC tenant units on active duty installations must use AFCEC/CP waiver processing guidelines.

**B1-3 NAVY AND MARINE CORPS.**

**B1-3.1 Applicability.**

See Chapter 1 for Scope and Applicability of criteria.

### **B1-3.1.1 Use of Criteria.**

The criteria in this UFC apply to Navy and Marine Corps aviation facilities located in the United States, its territories, trusts, and possessions. Where a Navy or Marine Corps aviation facility is a tenant on a civil airport, use these criteria to the extent practicable; otherwise, FAA criteria apply. Where a Navy or Marine Corps aviation facility is host to a civilian airport, these criteria will apply. Apply these standards to the extent practical at overseas locations where the Navy and Marine Corps have vested base rights. While the criteria in this UFC are not intended for use in a theater-of-operations situation, they may be used as a guideline where prolonged use is anticipated and no other standard has been designated.

### **B1-3.1.2 Criteria at Existing Facilities.**

See Chapter 1, Paragraph 1-3 for additional guidance and requirements for existing facilities where mission has changed. The criteria will be used for planning new aviation facilities and new airfield pavements at existing aviation facilities (exception: primary surface width for Class B runway). Existing aviation facilities have been developed using previous standards which may not conform to the criteria herein. Safety clearances at existing aviation facilities need not be upgraded solely for the purpose of conforming to these criteria. However, at existing aviation facilities where few structures have been constructed in accordance with previous safety clearances, it may be feasible to apply the revised standards herein.

### **B1-3.2 Navy/Marine Corps Design and Airfield Safety Waiver Processes.**

Waivers can be temporary or permanent in nature and various NAVY, NAVFAC, NAVAIR and USMC documents may use different terminology for their respective purposes. The primary purpose of this UFC is to offer criteria for new facilities. Mil-STD 3007 contains NAVFAC waiver and exemption requirements. However, waivers may be required from multiple authorities.

#### **B1-3.2.1 NAVFAC UFC Waivers.**

NAVFAC UFC Waivers are waivers or exemptions to criteria (per Mil-STD 3007) addressing design considerations of new facilities. The need for such waiver may arise during the planning site approval process or during project design. The site approval process and resources are documented in NAVFACINST 11010.45A, Site Approval Request (SAR) Process. Generally, if criteria is not being met during the planning or design phase, both NAVFAC UFC and NAVAIR Airfield Safety Waivers are required if another site avoiding violations cannot be selected. All waivers to the NAVFAC UFC program are contained in MIL-STD 3007. However, a joint process using the NAVAIR IBONS system has been developed to satisfy the NAVFAC Mil-STD process and the NAVAIR process since it will also be necessary to seek a NAVAIR Airfield Safety Waiver to support the NAVFAC UFC Waiver (see Paragraph B1-3.2.2).



For additional information about the NAVFAC Site Approval Request (SAR) process, copies of policies, Asset Management Bulletins, and latest Installation Site Approval Request Team (ISART) Resource, in addition to links to relevant NAVFAC Business Management Systems (e.g. Standard BMS, Airfield Safety BMS), and Points of Contact (POCs), etc., visit the SAR process website on the NAVFAC portal, at:

<https://hub.navfac.navy.mil/webcenter/portal/am/page1848/>

NOTE: Authorized DOD personnel must have a CAC card. When prompted, you may utilize the name and email address of the NAVFAC SAR Process program manager to obtain access to the HQ NAVFAC website.

### **B1-3.2.2      NAVAIR Airfield Safety Waivers.**

NAVAIR Airfield Safety Waivers are temporary or permanent waivers to criteria which incorporate air operations safety and risk considerations and operational mitigations. It is acknowledged that NAVAIR is the authority for Airfield Safety and shares this UFC for the purposes of managing the NAVAIR Airfield Safety Waiver Program. Generally, it is necessary to seek NAVAIR waivers during the site planning/approval, design, and construction phases or for existing facilities and other situations as defined by CNIC (per NAVAIR 00-80T-124 NATOPS Air Operations Manual) and other NAVAIR policies. The NAVAIR IBONS system can be used to request both a NAVFAC and NAVAIR waiver or just a NAVAIR waiver depending on the situation.

The joint NAVFAC/NAVAIR process is under development and if not available, separate waivers using separate processes must be sought. For IBONS Access: Go to the following link : <https://ibons.navair.navy.mil/ibons>

Must have CAC and utilize your CAC for log in.

Go to "Get an entry URL"

Complete the information and submit.

Access will be granted within 24 hours.

### **B1-3.3      Exceptions from Waivers.**

See Chapter 2 for Navy and Marine Corps facilities excepted from waivers.

THIS PAGE INTENTIONALLY BLANK

CANCELLED

**APPENDIX B  
SECTION 2  
LAND USE AND FACILITY SPACE -- ALLOWANCES**

**B2-1           APPLICABILITY.**

**B2-1.1        Army.**

For Army facility space allowances, see DAPAM 415-28, *Guide to Army Real Property Category Codes*.

**B2-1.2        Air Force.**

For Air Force facility space allowances, see AFI 32-1024, *Standard Facility Requirements* and AFH 32-1084, *Facility Requirements*.

**B2-1.3        Navy and Marine Corps.**

This section does not apply to the Navy and Marine Corps. For Navy and Marine Corps facility space allowances, see UFC 2-000-05N, *Facility Planning for Navy and Marine Corps Shore Installations*.

CANCELLED

THIS PAGE INTENTIONALLY BLANK

CANCELLED

**APPENDIX B  
SECTION 3  
DOD AIR INSTALLATIONS COMPATIBLE USE ZONES**

**B3-1 REFERENCES.**

Refer to the following documents for the latest guidance on air installation land use compatibility guidelines. Also, refer to paragraph 3-12 and Table 3-5 for additional information on the graded area of clear zones.

**B3-1.1 DoD.**

DoDI 4165.57 provides the DoD policy for Service AICUZ program management.

**B3-1.2 Air Force.**

Air Force land use guidelines are provided in AFI 32-7063 and AFH 32-7084.

**B3-1.3 Navy and Marine Corps.**

For Navy and Marine Corps installations, see OPNAVINST 11010.36C/MCO 11010.16 (or latest version).

THIS PAGE INTENTIONALLY BLANK

CANCELLED

**APPENDIX B  
SECTION 4  
WIND COVERAGE STUDIES**

**B4-1 APPLICABILITY.**

**B4-1.1 Army.**

One factor in the determination of the runway and helipad orientation is wind coverage, as discussed in Chapter 3. Runway and helipad orientation based on wind coverage for Army airfields will be determined in accordance with the methodology presented in FAA AC 150/5300-13, Appendix 1, "Wind Analysis." The runway or helipad orientation should obtain 95 percent wind coverage with a 19.5 kilometer-per-hour (10.5 knot) crosswind. If this coverage cannot be attained, a crosswind runway would be desirable.

**B4-1.2 Air Force.**

One factor in the determination of the runway orientation is wind coverage, as discussed in Chapter 3. Runway orientation based on wind coverage for Air Force airfields will be determined in accordance with the methodology presented in FAA AC 150/5300-13, Appendix 1, "Wind Analysis." Criteria for crosswind runway authorization will be in accordance with criteria presented in AFH 32-1084. AF/A3O, Director of Operations, must approve authorization for crosswind runways.

**B4-1.3 Navy and Marine Corps.**

Runway orientation for Navy and Marine Corps airfields will be determined in accordance with this section. Criteria for the crosswind runways are found in paragraph B4-6.

**B4-2 OBJECTIVE.**

This section provides guidance on the assembly and analysis of wind data to prepare a wind coverage study to determine runway and helipad orientation. It also provides guidance on analyzing the operational impact of winds on existing runways and helipads.

**B4-3 GENERAL.**

A factor influencing runway and helipad orientation is wind. Ideally, a runway or helipad should be aligned with the prevailing wind. Wind conditions affect all airplanes in varying degrees. Generally, the smaller the airplane, the more it is affected by wind, particularly crosswind components.

**B4-3.1 Basic Conditions.**

The most desirable runway or helipad orientation based on wind is the one which has the largest wind coverage and minimum crosswind components. Wind coverage is that percent of time crosswind components are below an acceptable velocity. The desirable wind coverage for an airport is 95 percent, based on the total number of weather observations.

### **B4-3.2 Meteorological Conditions.**

The latest and best wind information should be used to carry out a wind coverage study. A record which covers the last five consecutive years of wind observations is preferred. Ascertain frequency of occurrence, singly and in combination, for wind (direction and velocity), temperature, humidity, barometric pressure, clouds (type and amount), visibility (ceiling), precipitation (type and amount), thunderstorms, and any other unusual weather conditions peculiar to the area.

#### **B4-3.2.1 Usable Data.**

Use only data which give representative average values. For example, do not consider extremes of wind velocity during infrequent thunderstorms of short duration.

#### **B4-3.2.2 Source of Data.**

Obtain meteorological data from one or more of the following sources:

- National Oceanic and Atmospheric Administration, Environmental Data Service
- National Weather Service
- Bureau of Reclamation
- Forest Service
- Soil Conservation Service
- Federal Aviation Administration
- Army Corps of Engineers
- Navy Oceanographic Office
- Geological Survey
- US Air Force

### **B4-4 WIND VELOCITY AND DIRECTION.**

The following are the most important meteorological factors determining runway and helipad orientation:

#### **B4-4.1 Composite Windrose.**



When weather recording stations are located near a proposed site and intervening terrain is level or slightly rolling, prepare a composite windrose from data of surrounding stations.

**B4-4.2 Terrain.**

If intervening terrain is mountainous or contains lakes or large rivers, allow for their effects on wind velocities and directions by judgment, after study of topographical information and available meteorological data.

**B4-4.3 Additional Weather Data.**

Consider wind directions and velocities in conjunction with visibility, precipitation, and other pertinent weather information.

**B4-4.4 Wind Distribution.**

Determine wind distribution to accompany instrument flight rule (IFR) conditions when considering orientation of an instrument runway.

**B4-5 USE OF WINDROSE DIAGRAMS.**

Prepare a windrose diagram for each new runway or helipad in the planning stage or to analyze the operational impact of wind on existing runways or helipads.

**B4-5.1 Drawing the Windrose.**

The standard windrose (Figures B4-1 and B4-2) consists of a series of concentric circles cut by radial lines. The perimeter of each concentric circle represents the division between successive wind speed groupings. Radial lines are drawn so that the area between each successive pair is centered on the direction of the reported wind.

**B4-5.2 Special Conditions.**

Windrose diagrams for special meteorological conditions, such as wind velocities and directions during IFR conditions, should be prepared when necessary for local airfield needs.

**B4-5.2.1 Wind Direction.**

Use radial lines to represent compass directions based on true north, and concentric circles, drawn to scale, to represent wind velocities measured from the center of the circle.

**B4-5.2.2 Calm Wind.**

Use the innermost circle to encompass calm periods and wind velocities up to the allowable crosswind component for the airfield under consideration.

**B4-5.2.3 Computations.**

Compute percentages of time that winds of indicated velocities and directions occur, and insert them in the segments bounded by the appropriate radial direction lines and concentric wind velocity circles. Express percentages to the nearest tenth, which is adequate and consistent with wind data accuracy. Figure B4-3 displays a completed windrose.

CANCELLED

Figure B4-1. Windrose Blank Showing Direction and Divisions  
(16-Sector [22.5°] Windrose)

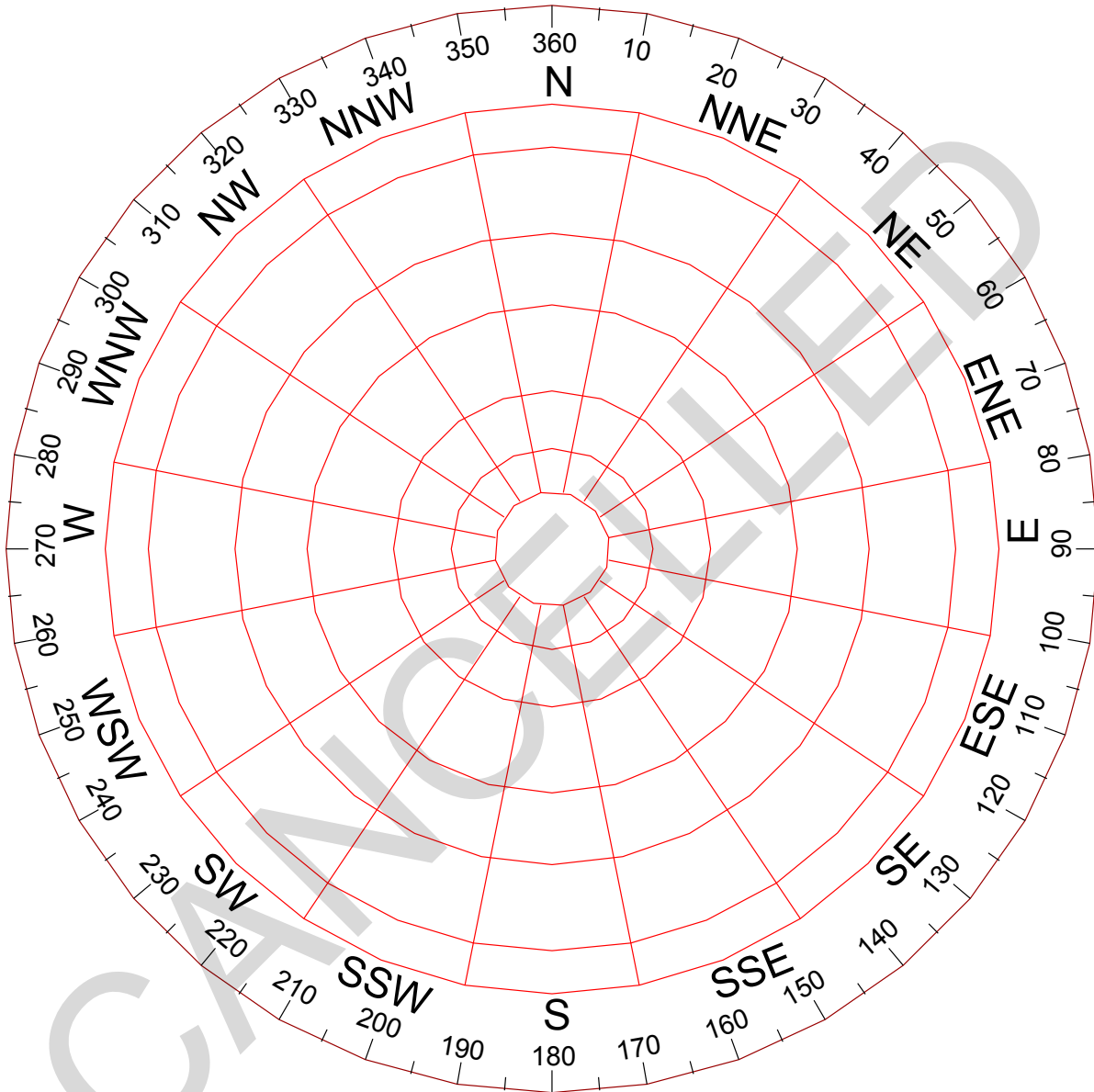

Figure B4-2. Windrose Blank Showing Direction and Divisions  
(36-Sector [10°] Windrose)

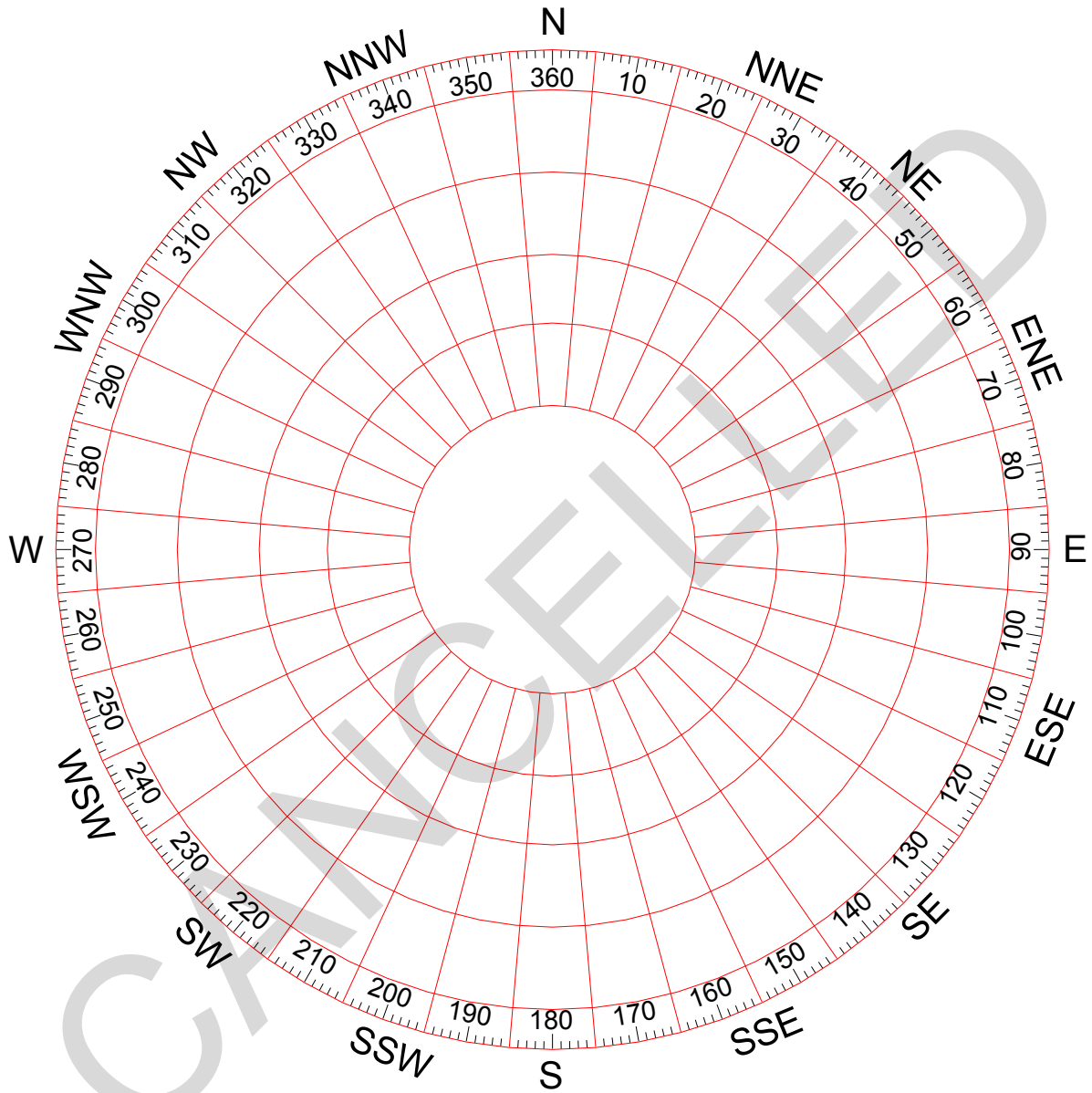
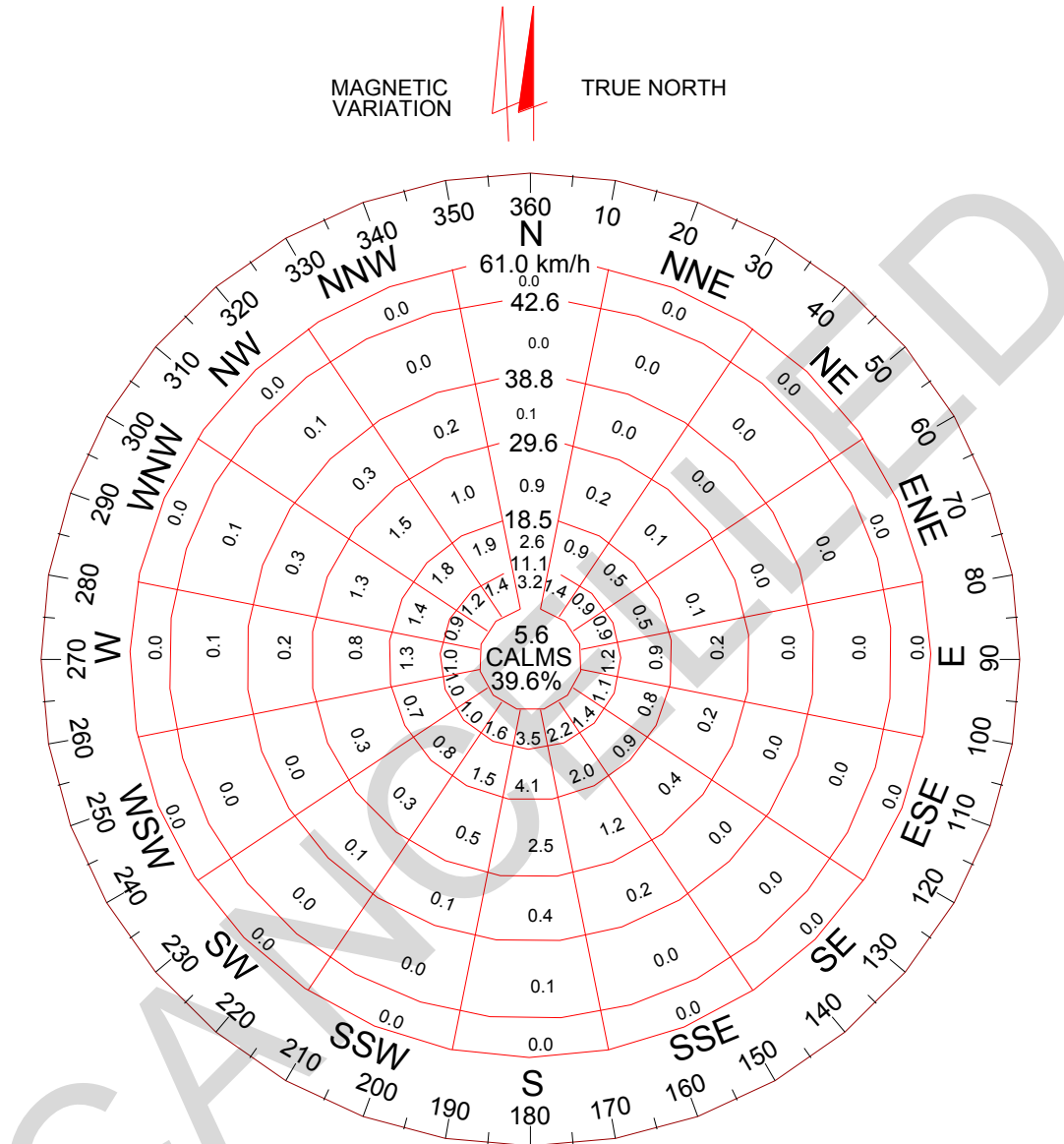

Figure B4-3. Completed Windrose and Wind Velocity Equivalents  
(16-Sector [22.5°] Windrose)



WIND VELOCITY EQUIVALENTS		
KNOTS	KM/H	MPH
3	5.6	3.5
6	11.1	6.9
10	18.5	11.5
16	29.6	18.4
21	38.8	24.2
23	42.6	26.5
33	61.0	37.9

**B4-5.2.4 Crosswind Template.**

A transparent crosswind template is a useful aid in carrying out the windrose analysis. The template is essentially a series of three parallel lines drawn to the same scale as the windrose circles. The allowable crosswind for the runway width establishes the physical distance between the outer parallel lines and the centerline.

**B4-5.3 Desired Runway or Helipad Orientation.**

For the use of windrose diagrams and crosswind templates in determining desirable runway or helipad orientations with respect to wind coverage, see Figure B4-4.

CANCELLED

Figure B4-4. Windrose Analysis

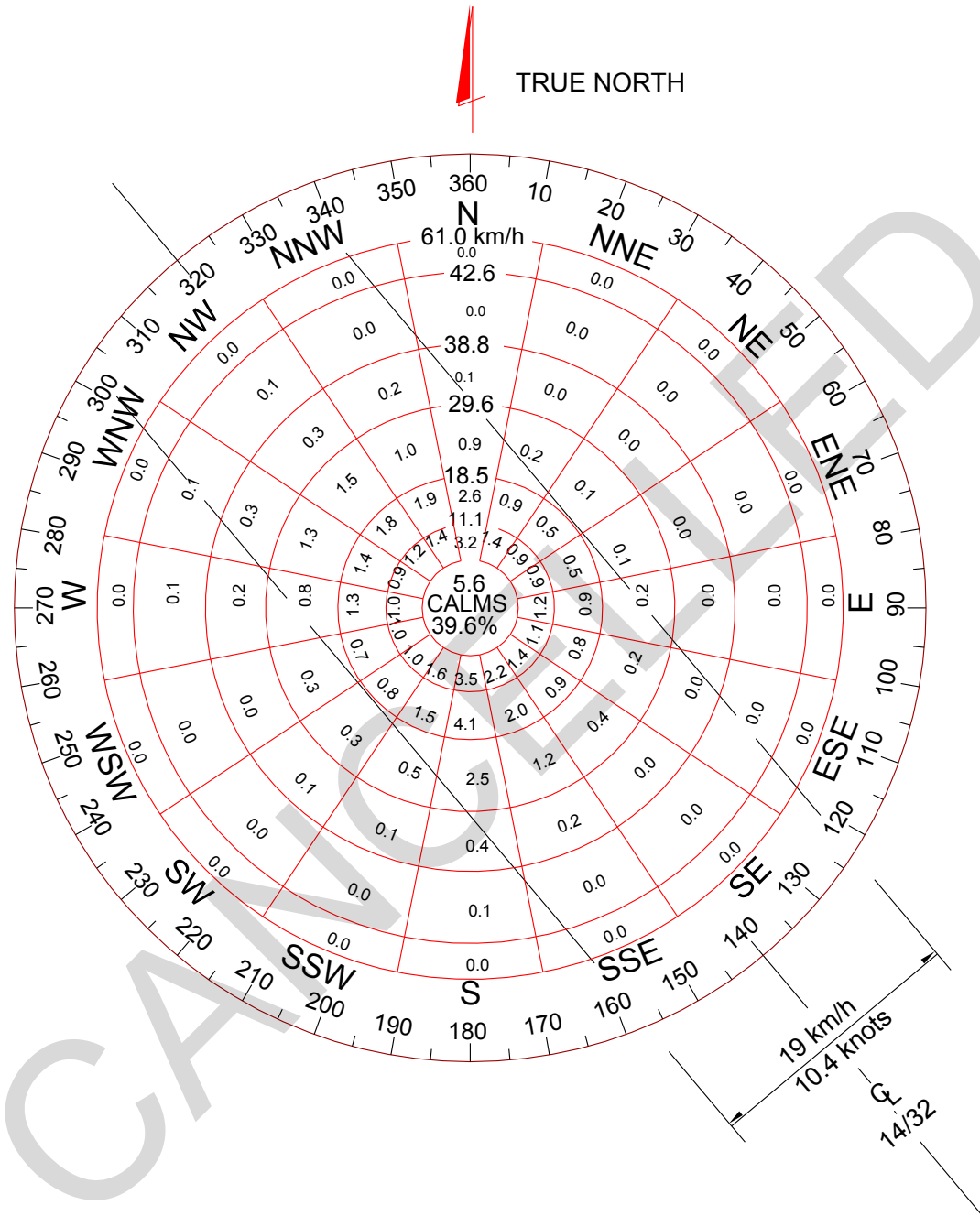

**NOTE:** A runway oriented 140° to 320° (true) would have 3.1 percent of winds exceeding the design crosswind component of 19 km/h.

## **B4-6 WIND COVERAGE REQUIREMENTS FOR RUNWAYS.**

Determine the runway orientation which provides the greatest wind coverage within the allowable crosswind limits. Place runways to obtain at least 95 percent wind coverage of the maximum allowable crosswind components, as discussed in paragraph B4-6.3. It is accepted practice to total the percentages of the segments appearing outside the limit lines and to subtract this number from 100. For analysis purposes, winds are assumed to be uniformly distributed throughout each of the individual segments. The larger the area or segment, the less accurate this presumption.

### **B4-6.1 Primary Runways or Helipads.**

Orient a primary runway or helipad for the maximum possible wind coverage. See Figure B4-4 for the method of determining wind coverage.

### **B4-6.2 Secondary Runways.**

Where wind coverage of the primary runway is less than 95 percent, or in the case of some localities where during periods of restricted visibility the wind is from a direction other than the direction of the primary runway, a secondary (crosswind) runway is required. Normally, secondary runways will not be planned without prior authorization from Naval Air Systems Command. The secondary runway will be oriented so that the angle between the primary and secondary runway centerline is as near 90 degrees as is feasible, considering local site conditions and the need to provide maximum crosswind coverage.

### **B4-6.3 Maximum Allowable Crosswind Components (Navy Only).**

Select these components according to type of aircraft, as follows: (1) tricycle gear aircraft, 28.0 kilometers per hour (15.0 knots); and (2) conventional gear aircraft, 19.5 kilometers per hour (10.5 knots).

### **B4-6.4 Allowable Variations of Wind Direction.**

See Figure B4-5 for allowable wind directions.



Figure B4-5. Allowable Wind Variation for 19 Kilometer-per-Hour (10.4 Knot) and 28 Kilometer-per-Hour (15 Knot) Beam Wind Components

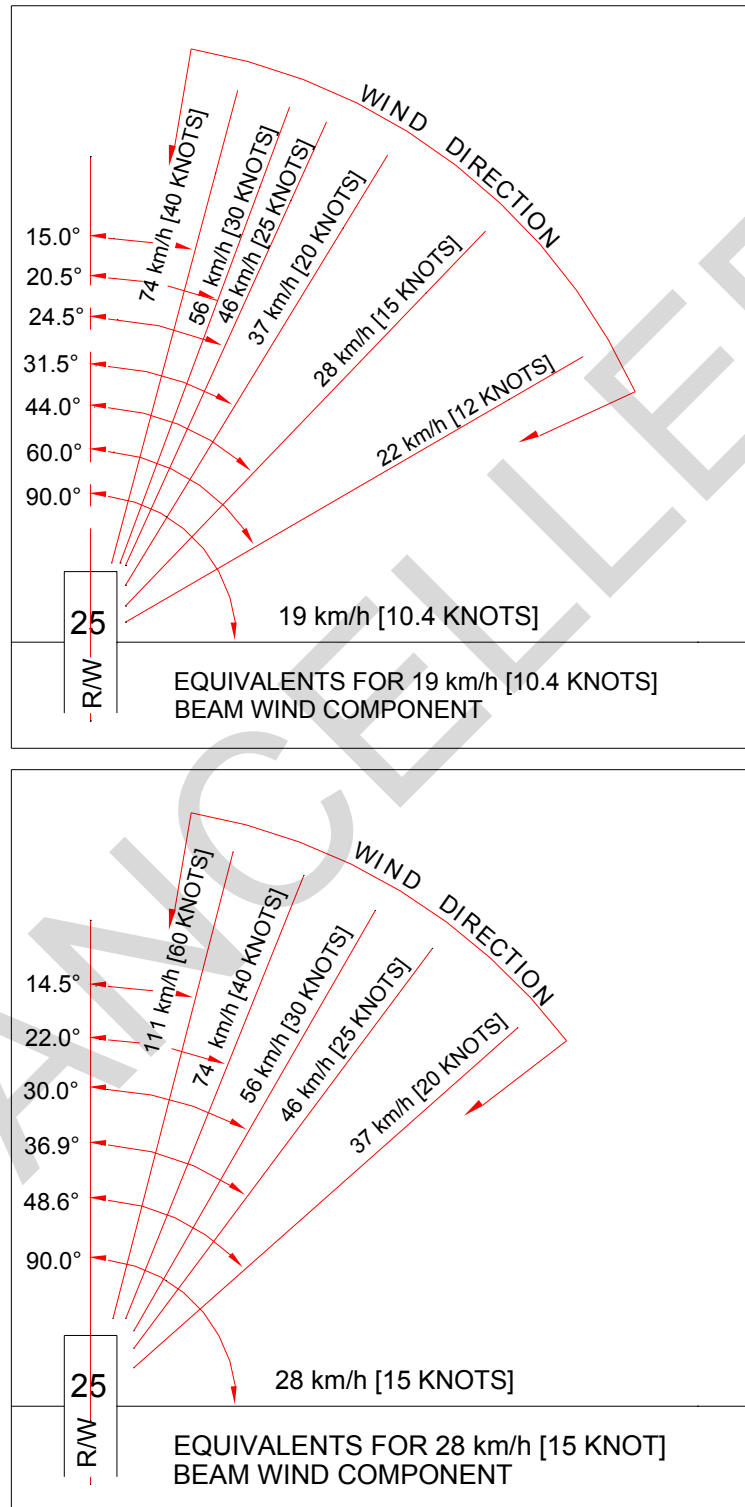

THIS PAGE INTENTIONALLY BLANK

CANCELLED

**APPENDIX B  
SECTION 5  
FEDERAL AVIATION REGULATION PART 77, OBJECTS AFFECTING NAVIGABLE  
AIRSPACE**

**NOTE:** FAR Part 77 is periodically updated. Check <https://www.gpo.gov/fdsys/pkg/CFR-2012-title14-vol2/xml/CFR-2012-title14-vol2-part77.xml#seqnum77.5> for the most current version of the regulation.

CANCELLED

THIS PAGE INTENTIONALLY BLANK

CANCELLED

**APPENDIX B  
SECTION 6  
AIRCRAFT CHARACTERISTICS FOR  
AIRFIELD-HELIPORT DESIGN AND EVALUATION**

**B6-1 GENERAL.**

Aircraft characteristics, including aircraft dimensions, weights, and other information for Military Aircraft are available in Technical Report TSC 13-2, and for Selective Commercial Aircraft are available in Technical Report TSC 13-3. Both documents are available at <https://transportation.erdcdren.mil/tsmcx/criteria.aspx>. This ETL is not all-inclusive. Refer to the Mission Design Series (MDS) Facilities Requirements Document (FRD) for late model aircraft characteristics.

CANCELLED

THIS PAGE INTENTIONALLY BLANK

CANCELLED

**APPENDIX B  
SECTION 7  
JET BLAST EFFECTS**

**B7-1 CONTENTS.**

Jet blast affects various operational areas at an airport. Personnel safety is a major concern in terminal, maintenance, and cargo areas.

**B7-2 CONSIDERATIONS.**

The effects of jet blast are far more serious than those of prop wash and must be considered when designing aircraft parking configurations for all military and civil aircraft. These high velocities are capable of causing bodily injury to personnel, damage to airport equipment, or damage to certain pavements and other erodible surfaces.

**B7-2.1 Blast Temperatures.**

High temperatures are also a by-product of jet exhaust. The area exposed to hazardous high temperatures is typically smaller than the area subjected to hazardous blast velocities.

**B7-2.2 Blast Velocities.**

Blast velocities greater than 48 kilometers per hour (30 miles per hour) can cause loose objects on the pavement to become airborne and injure personnel who may be a considerable distance behind the aircraft. The layout of aviation facilities must protect personnel from projectiles.

**B7-2.3 Minimum Clearances.**

The minimum clearance from the rear of a jet operating at military power to dissipate the temperature and velocity to levels that will not endanger aircraft personnel and damage other aircraft is referred to as the safe distance. Safe distances are discussed in paragraph B7-5.

**B7-2.4 Engine Blast Relationship.**

Each jet engine has its own footprint of temperature and velocity versus distance. Jet blast relationships for Army, Air Force, and selected civil aircraft may be obtained from the source listed in Appendix B, Section 6, or from the Facilities Requirements Document (FRD) for the specific Mission Design Series (MDS). The relationships are in graphical format showing velocity versus distance and temperature versus distance at various power settings. The planner/designer should obtain the jet blast relationship when the effects of jet blast could create a hazardous condition for personnel and equipment.

**B7-3 PROTECTION FROM JET BLAST EFFECTS.**

### **B7-3.1 Blast Deflectors.**

Equipment such as blast deflectors may be required at locations where continued jet engine run-up interferes with the parking or taxiing of aircraft, the movement of vehicles, and the activities of maintenance or aircraft personnel. Additional information on jet blast deflectors is presented in Appendix B, Section 8.

### **B7-3.2 Unprotected Areas.**

Unprotected areas of the airfield which receive continued exposure to jet blast can erode and cause release of soil, stones, and other debris that can be ingested into jet engines and cause engine damage.

### **B7-3.3 Minimum Distances for Run-Up.**

See Appendix B, Section 12 for minimum distances from the rear of jet aircraft to the edge of adjacent asphalt pavements. Run-up pads must be sized to provide a minimum of 7.62 meters (25 feet) of Portland cement concrete (PCC) aft of the aircraft fuselage to prevent damage to the aircraft in the event the pavement fails due to jet blast.

## **B7-4 NOISE CONSIDERATIONS.**

Protection against noise exposure is required whenever the sound level exceeds 85 dB(A) continuous, or 140 dB(A) impulse, regardless of the duration of exposure.

## **B7-5 JET BLAST REQUIREMENTS.**

### **B7-5.1 Parked Aircraft.**

A minimum clearance (safe distance) is needed to the rear of an engine to dissipate jet blast to less than 56 kilometers per hour (35 miles per hour) and jet exhaust temperatures to 38 degrees Celsius (100 degrees Fahrenheit) or ambient, whichever is more—otherwise, a jet blast deflector is needed. Velocities of 48 kilometers per hour (30 miles per hour) to 56 kilometers per hour (35 miles per hour) can occur over 490 meters (1,600 feet) to the rear of certain aircraft with engines operating at takeoff thrust. However, these velocities decrease rapidly with distance behind the jet engine.

### **B7-5.2 Taxiing Aircraft.**

The distance from the rear of the aircraft engine to the wingtip of other aircraft will be:

- A distance such that jet blast temperature will not exceed 38 degrees Celsius (100 degrees Fahrenheit);
- A distance such that jet blast velocity will not exceed 56 kilometers per hour (35 miles per hour).



**APPENDIX B  
SECTION 8  
JET BLAST DEFLECTOR**

**B8-1 OVERVIEW.**

Jet blast deflectors can substantially reduce the damaging effects of jet blast on structures, equipment, and personnel. Jet blast deflectors can also reduce the effects of noise and fumes associated with jet engine operation. Erosion of shoulders not protected by asphaltic concrete surfacing can be mitigated by blast deflectors. Blast deflectors consist of a concave corrugated sheet metal surface, with or without baffles, fastened and braced to a concrete base to withstand the force of the jet blast and deflect it upward.

**B8-1.1 Location.**

The deflector is usually located 21 meters (70 feet) to 37 meters (120 feet) aft of the jet engine nozzle, but not less than 15 meters (50 feet) from the tail of the aircraft.

**B8-1.2 Size and Configuration.**

Size and configuration of jet blast deflectors are based on jet blast velocity and location and elevation of nozzles. Commercially available jet blast deflectors should be considered when designing jet blast protection.

**B8-1.3 Paved Shoulders.**

For blast deflectors placed off the edge of a paved apron, a paved shoulder is required between the blast deflector and the edge of the paved apron.

THIS PAGE INTENTIONALLY BLANK

CANCELLED

**APPENDIX B  
SECTION 9  
EXPLOSIVES ON OR NEAR AIRFIELDS**

**B9-1 CONTENTS.**

All explosives locations, including locations where aircraft loaded with explosives are parked, must be sited in accordance with DoD Standard 6055.09-M and applicable Service explosives safety regulations. Explosives site plans, approved through command channels to DoD, ensure that minimal acceptable risk exists between explosives and other airfield resources. To prevent inadvertent ignition of Electrically Initiated Devices (EID), separation between sources of electromagnetic radiation is required. Separation distances must be according to safe separation distance criteria. Grounding requirements, lightning protection, and further considerations for explosives on aircraft are presented below.

**B9-2 SEPARATION DISTANCE REQUIREMENTS.**

See Chapter 1, Paragraph 1-4.1 for explosive safety criteria requirements and other facility design criteria.

**B9-3 PROHIBITED ZONES.**

Explosives, explosive facilities, and parked explosives-loaded aircraft (or those being loaded or unloaded) are prohibited from being located in Accident Potential Zones (APZ) I and II and clear zones as set forth in AR 385-10; DAPAM 385-64, Chapter 5; AFMAN 91-201; and AFI 32-7063.

**B9-4 HAZARDS OF ELECTROMAGNETIC RADIATION TO EID.**

EID on aircraft are initiated electrically. The accidental firing of EID carried on aircraft initiated by stray electromagnetic energy is a possible hazard on an airfield. A large number of these devices are initiated by low levels of electrical energy and are susceptible to unintentional ignition by many forms of direct or induced stray electrical energy, such as radio frequency (RF) energy from ground and airborne emitters (transmitters). Additional sources of stray electrical energy are lightning discharges, static electricity or triboelectric (friction-generated) effects, and the operation of electrical and electronic subsystem onboard weapon systems. AFMAN 91-201 should be used as a guide in setting up safe separation between aircraft loaded with EID.

**B9-5 LIGHTNING PROTECTION.**

Lightning protection must be installed on open pads used for manufacturing, processing, handling, or storing explosives and ammunition. Lightning protection systems must comply with DoD 6055.09-M; AFM 88-9CH3/TM 5-811-3; AFI 32-1065; and National Fire Protection Association (NFPA) 780.

**B9-6 GROUNDING OF AIRCRAFT.**

Aircraft that are being loaded with explosives must be grounded at all times. Air Force grounding of aircraft will be in accordance with AFMAN 91-201 and applicable weapons systems technical orders (T.O.).

**B9-7            HOT REFUELING.**

Hot refueling is the transfer of fuel into an aircraft with one or more engines running. The purpose of hot refueling is to reduce aircraft ground time, personnel and support equipment requirements, and increase system reliability and effectiveness by eliminating system shut-down and restart. All hot refueling locations must be sited in accordance with DoD 6055.09-M and applicable Service explosives safety criteria.

CANCELLED

**APPENDIX B  
SECTION 10  
COMPASS CALIBRATION PAD MAGNETIC SURVEY**

**B10-1 CONTENTS.**

This section describes the procedures for performing a magnetic survey for new or existing compass calibration pad (CCP) by a state-registered land surveyor. These surveys will determine the following:

- Suitability of a particular site for use as a CCP.
- Variations of the magnetic field within the surveyed area.
- Magnetic declination of the area at the time of the survey.

**B10-2 AIR FORCE REQUIREMENTS.**

Air Force designers may use these criteria or the criteria given in Appendix 4 of FAA Advisory Circular (AC) 150/5300-13 (see paragraph 6-11.2).

**B10-3 CCP SURVEY AUTHORITIES AND RESOURCES.**

Many resources are available to perform CCP surveys including Registered Land Surveyors. However, additional government resources exist including:

U.S. Geological Survey

The U.S. Geological Survey (USGS) of the Department of Interior is available to provide information to airports and others on the necessary surveys and equipment to certify a compass rose. In addition, the USGS is available to calibrate magnetometers and other suitable instruments used to measure the magnetic field. The instruments are necessary to determine the difference between true and magnetic north and the uniformity of the magnetic field in the area of a compass calibration pad and must be regularly calibrated to make accurate measurements. The cost for calibration service is only that necessary to cover the cost. Requests for this service should be made to the following:

U.S. Geological Survey  
Geomagnetism Group  
Box 25046, MS 966  
Denver, CO 80225  
website: <https://www.geomag.usgs.gov>

National Geospatial-Intelligence Agency (NGA)

The NGA has capabilities to perform CCP surveys as well as other services. Each DoD branch of service must contact their respective representative to request compete their project need.

Navy Contact in NGA:  
GI&S Officer  
OPNAV N2N6E4 PNT  
Pentagon, 1D479  
571-256-8222

For the Navy, additional technical resources may be available from Naval Air Technical Data and Engineering Services Center (NATEC). See additional guidance in NAVAIR 05-15C-2 OPERATION, ORGANIZATIONAL AND INTERMEDIATE MAINTENANCE WITH ILLUSTRATED PARTS BREAKDOWN: A/E36T-2 MAGNETIC COMPASS CALIBRATOR SET or contact Naval Air Technical Data and Engineering Services Center (NATEC).

#### **B10-4 CCP SURVEY ACCURACY REQUIREMENTS.**

For the purpose of this survey, final calculations should be reported to the nearest one minute (1') of arc with an accuracy of  $\pm 10$  minutes (10'). Typically, magnetic variations can be determined to the nearest 30 minutes (30') of arc by using a conventional transit with a compass. The finer precision needed for these surveys may be obtained by taking a minimum of three readings at each site and then reporting their average. All azimuths must be established by the Global Positioning System (GPS) or Second Order Class II conventional control survey referenced to known positions within the North American Datum of 1983 (NAD83) adjustment network, or convert host nation datum to World Geodetic System 1984 (WGS-84).

#### **B10-5 PRELIMINARY SURVEY REQUIREMENTS.**

Preliminary surveys are conducted for proposed sites to determine that the areas are magnetically quiet and thus suitable for a CCP. They are also used to determine if newly constructed items within the influence zone (see paragraph B10-10.1) of an existing CCP are causing magnetic interference. When siting a new CCP, the location should be chosen such that all separation distances, as defined in paragraph B10-10.1, are allowed for to the greatest extent practical. A preliminary magnetic survey will then be conducted to determine if the area is magnetically quiet with no natural or manmade magnetic disturbances. When conducting the preliminary survey, the surveyor must immediately notify the agency requesting the survey of any areas they find that are causing magnetic interferences so they can try to identify and remove the interference and also determine if the survey should continue any further. The location of the anomaly can be pinpointed by taking readings at additional points around the disturbed area and finding the location with the highest disturbance. If the magnetic anomaly cannot be removed and the site made magnetically quiet, then a new site will need to be chosen. One of the following methods is suggested for a preliminary survey.

**B10-5.1 Proton Magnetometer Method.**

A proton magnetometer can be used by walking over the area and making observations approximately every 6 meters (20 feet) in a grid pattern covering the site. If the values measured do not vary from any other reading by more than 25 gammas for the whole area, then the site can be considered magnetically quiet.

**B10-5.2 Distant Object Method.**

A distant landmark is selected for siting from the various points, 6-meter (20-foot) grid pattern, of the area being checked. A second distant object at approximately 90 degrees (90°) can also be chosen to increase accuracy. The further away the distant object is, the wider an area of points that can be compared to each other and still obtain the accuracy needed. An 8-kilometer (5-mile) -distant object will allow a comparison of magnetic declinations of points within a 24-meter (80-foot) -wide path in the direction of the distant object; while a 24-kilometer (15-mile) -distant object will allow a comparison of points within a 73-meter (240-foot) width, or effectively, the whole CCP site. If the magnetic declinations of the different points vary by more than 12 minutes (12') of arc then the site is not magnetically quiet.

**B10-5.3 Reciprocal Observation Method.**

Several scattered points are selected and marked in the area to be tested. The transit is set up over one central point and the magnetic azimuth to all of the other points is determined and recorded. Then the transit is set up over all the other points and a back azimuth to the central point is determined and recorded. If there are no magnetic disturbances then the original azimuth and the back azimuth should be the same for each of the points checked. If there is a difference between the azimuth and back azimuth of any of the points which is greater than 12 minutes (12') of arc, then the site is not magnetically quiet.

**B10-6 MAGNETIC SURVEY REQUIREMENTS.**

See paragraph 6-11 for CCP initial, re-surveying, and re-marking requirements.

**B10-7 MAGNETIC SURVEY PROCEDURES.**

These procedures consist of the magnetic field survey used to determine the magnetic declination of a site and the magnetic direction survey used to lay out the CCP markings. Both a magnetic field survey and a magnetic direction survey of the CCP will be performed at the frequency defined in Chapter 6 and when magnetic influences have occurred within or adjacent to the CCP. Magnetic influences are considered to be additions of power lines, installation of items containing ferrous metals, or similar activities within an influencing distance of the CCP as defined in paragraph B10-10.1.

**B10-7.1 Magnetic Field Survey.**

This survey is to measure the magnetic declination within the CCP area. The surveyor will be required to certify that the variations of the magnetic field are within the allowable range and to provide the average magnetic declination of the area. The direction of the horizontal component of the Earth's magnetic field (magnetic declination) measured at any point within a space between 0.6 meter (2 feet) and 1.8 meters (6 feet) above the surface of the CCP and extending over the entire area of the CCP must not differ by more than 12 minutes (12') of arc from the direction measured at any other point within this area. All raw data, intermediate computations, and final results shall be submitted in a clear, neat, and concise format. The surveyor shall accurately lay out a 6-meter by 6-meter (20-foot by 20-foot) grid with its center point coincident with the center point of the CCP. The grid will be laid out so the entire area of the CCP plus a minimum of 6 meters (20 feet) outside each edge of the CCP is covered. The grid may be laid out in any direction, but a true north or a magnetic north direction is preferred since it will simplify the azimuth calculations and allow immediate recognition of points outside the allowable declination limits. In any case, the surveyor shall determine the true azimuth of the grid layout by standard surveying procedures so the azimuth and declination of each point can be determined. After the grid is laid out, the surveyor shall check the declination of all the grid points by one of the following methods:

#### **B10-7.1.1 Distant Object Method.**

A distant landmark is selected for siting from the various points of the area being checked. A second distant object at approximately 90 degrees (90°) can also be chosen to increase accuracy. The further away the distant object is, the wider an area of points that can be compared to each other and still obtain the accuracy needed. An 8-kilometer (5-mile) -distant object will allow a comparison of magnetic declinations of points that are within a 24-meter (80-foot) -wide path in the direction of the distant object; while a 24-kilometer (15-mile) -distant object will allow a comparison of points within a 73-meter (240-foot) width, or effectively, the whole CCP site. If a distant object cannot be chosen far enough away to accurately compare the whole sight (at no time will a distant object be closer than 8 kilometers [5 miles]), then corrections for the eccentricity would have to be made. If the grid were laid out so its center was in line with the distant object and an equal number of points were laid out on either side of this centerline, then this eccentricity would automatically be corrected when the azimuths are averaged. But the points can only be compared to other points within the allowable path width when checking for disturbances in the declinations, unless corrections for the eccentricities are allowed for. The average value is then computed, adjusting for eccentricities if necessary, and reported as the site declination.

#### **B10-7.1.2 Distant Hub Method.**

After the grid is laid out, lay out additional hubs a minimum of 90 meters (300 feet) in all four directions from the center point of the grid and designated as "Hub N," "Hub S," "Hub E," and "Hub W." "South Azimuth Marks" are placed perpendicular to the "Hub S," 6 meters (20 feet) apart, and coincident to the grid layout, as shown in Figure B10-1. Use these azimuth marks for sighting and taking declination readings. After the grid and azimuth marks are accurately set, the surveyor shall set up and level the transit



over the center point and sight it on the "Hub S" mark and zero the vernier. The surveyor then must release the compass needle and turn the transit to center it on the compass needle while all the time tapping the compass to minimize friction effects. Take a reading here (to the nearest one minute [1']) then deflect the compass needle with a small magnet, realign the transit with the compass and take a third reading. Average these three readings to provide the declination for this spot. The surveyor shall accurately record the time to the nearest minute for the first and third reading. After the readings are completed for the center point (which will be used for reference), the surveyor shall then set up the transit over the other points of the grid and follow the same steps as above while sighting at the appropriate "Azimuth Mark" and determine the declination of each of these grid points. Approximately every 20 to 30 minutes, or any time a reading turns out to be outside the allowable 12 minutes (12') of arc, the surveyor must re-setup over the center point and take new readings to check for diurnal changes in the declination. If readings are found to be outside the allowable 12 minutes (12') of arc, after making corrections for diurnal changes, the surveyor shall set up at the bad point and re-check it to see if the results are repeatable. If all the readings are within the required 12 minutes (12') after the surveyor has made diurnal corrections, then average these readings and determine the site declination.

Figure B10-1. Magnetic Field Survey Sheet

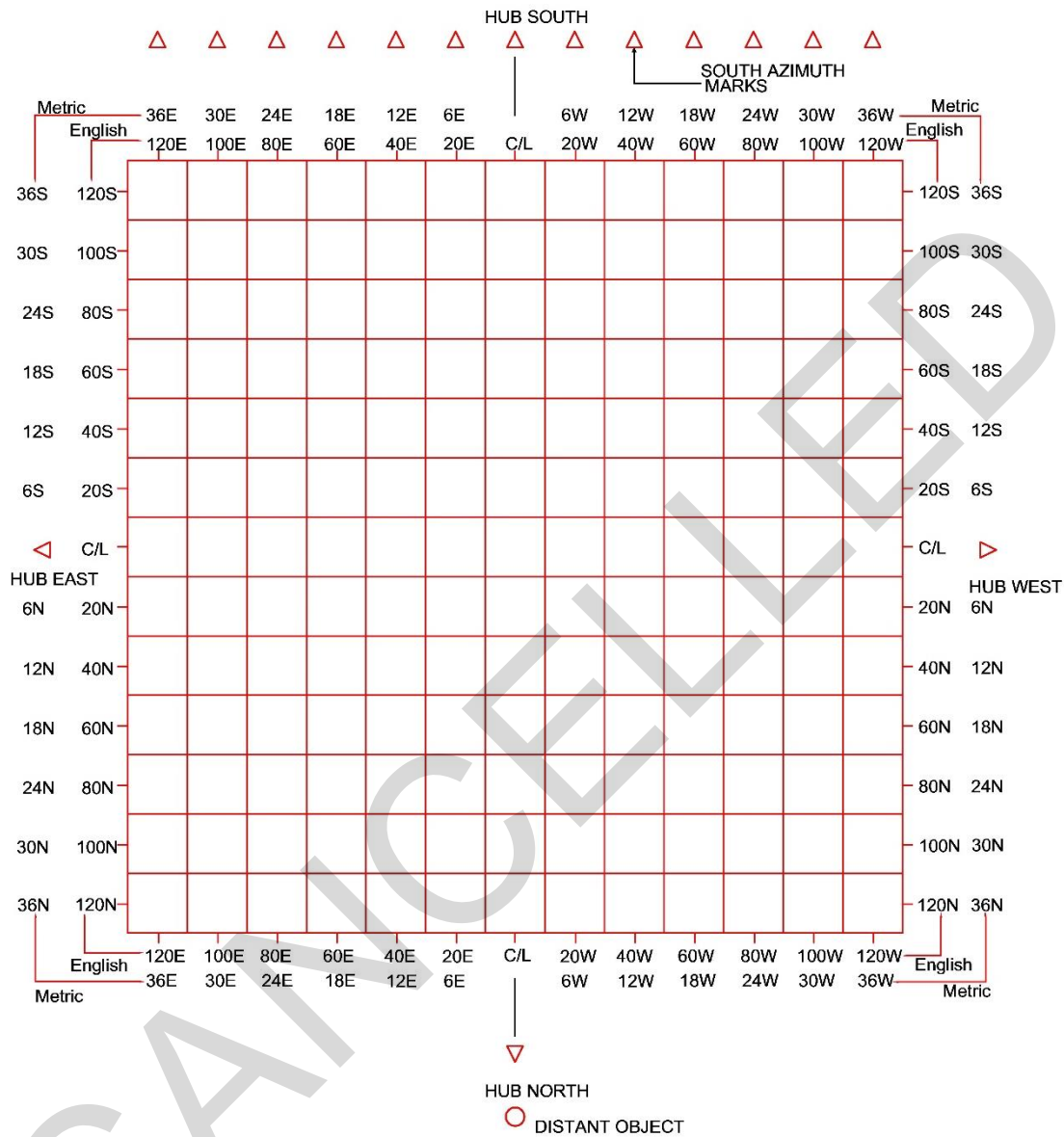

**B10-7.2 Magnetic Direction Survey.**

A magnetic direction survey is an engineering survey used to establish and verify the location of control points and to layout and verify the markings for a CCP.

**B10-8 CCP CONTROL POINTS.**

CCP control points shall be located and verified using a magnetic direction survey.

**B10-8.1 New CCP Control Points.**

For new CCP, the surveyor shall determine the center of the pad and mark it with a bronze surveying marker accurately grouted in place. Stamp this point "Center of Calibration Pad." After the center point is located and set, the surveyor shall accurately locate and set the following control points and pavement markings in a similar manner. See Figures B10-2 and B10-3 for greater detail of the control point layout.

#### **B10-8.1.1 True North and South Control Points.**

Set a north and south control point on a "true north-south" line established through the center of the calibration pad marker. The north-south control points must be located radially from the center of the compass calibration pad at a distance of 9 meters (30 feet). Stamp these points "N<sub>T</sub>" for the north point and "S<sub>T</sub>" for the south point. Stamp the markers with "True North (South) - Established 'Day' 'Month' 'Year.' "

#### **B10-8.1.2 Magnetic North Control Point.**

Set a magnetic north control point on the "magnetic north azimuth" as determined by the magnetic survey. The magnetic north control point must be located radially from the center of the compass calibration pad at a distance of 12 meters (40 feet). Mark this point on the pavement with a "Nm" above the point at 12.3 meters (41 feet) radially from the center point and " 'Month' 'Year' " below the point at 11.7 meters (39 feet) radially from the centerpoint. The date shall reflect when the magnetic north was established by a field magnetic survey. The markings shall consist of 300-millimeter (12-inch) -high block numerals with 75-millimeter (3-inch) -wide orange paint stripes. Stamp the bronze marker with "Magnetic North - Established 'Day' 'Month' 'Year'" and "Declination - 'Degrees' 'Minutes.' " True North-South.

#### **B10-8.2 Type I CCP Control Points.**

Type I CCPs require the Center, True North, True South, and Magnetic North Control Points described in paragraph B10-8.1. Figure B10-2 shows the control point layout for Type I CCPs.

#### **B10-8.3 Type II CCP Control Points.**

Type II CCPs require the Center, True North, True South, and Magnetic North Control Points described in paragraph B10-8.1. In addition, provide twenty-four (24) control points at 7.5 meters (25 feet) radially from the centerpoint beginning at true north and then every 15 degrees (15°). These points shall consist of bronze markers accurately grouted in place. Stamp each of these points with their true azimuth (for example, 15NT). Figure B10-3 shows the control point layout for Type II CCPs.

#### **B10-8.4 Existing CCPs.**

For existing CCP, the surveyor will be required to check the alignment of the magnetic north control point and adjust it if necessary. If the average magnetic declination, as determined by a magnetic field survey as described in paragraph B10-7.1, differs by

more than 0.5 degree (30 arc-min) from what is marked on the CCP then the CCP must be re-calibrated (see Chapter 6, Paragraph 6-11). First, all magnetic markings must be removed from the pavement. Then the magnetic north control point marker must be removed and reset to the correct position as described above for a new CCP. The CCP markings are then laid out and marked as described in Paragraph B10-9.

Figure B10-2. Typical Type I Compass Rose Control Point and Marking Layout

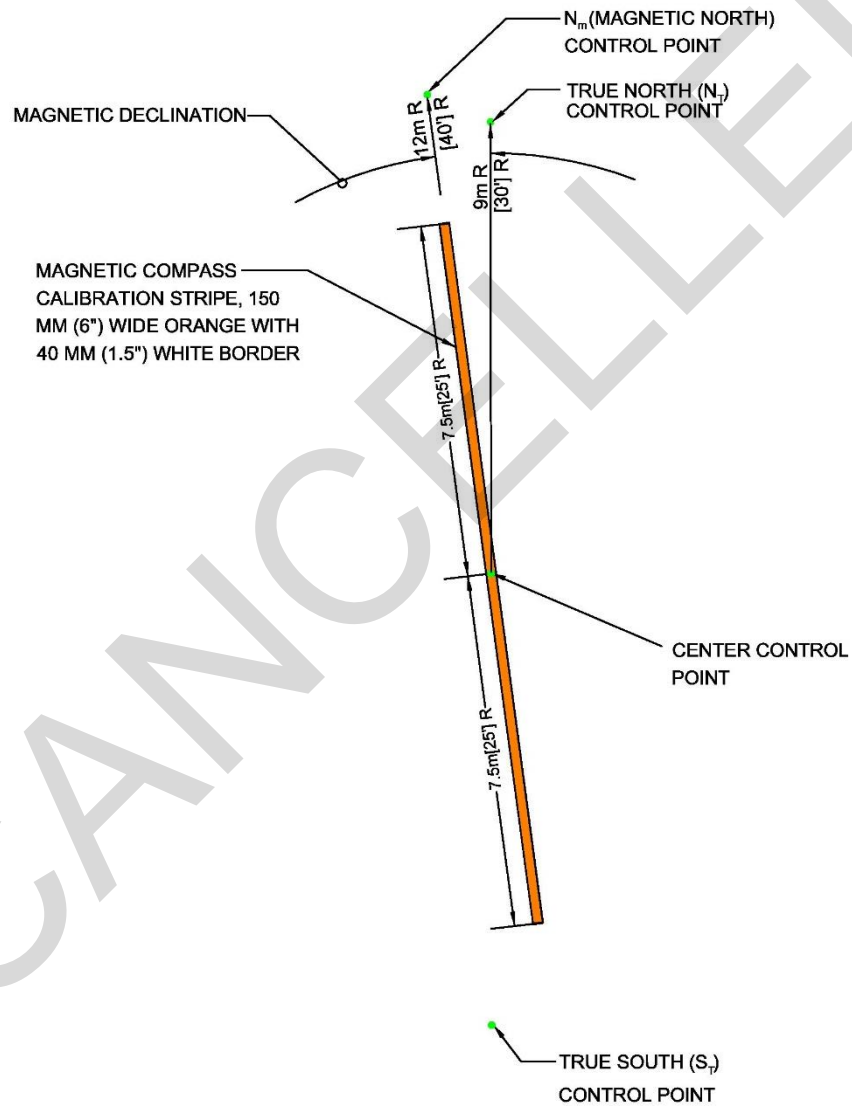
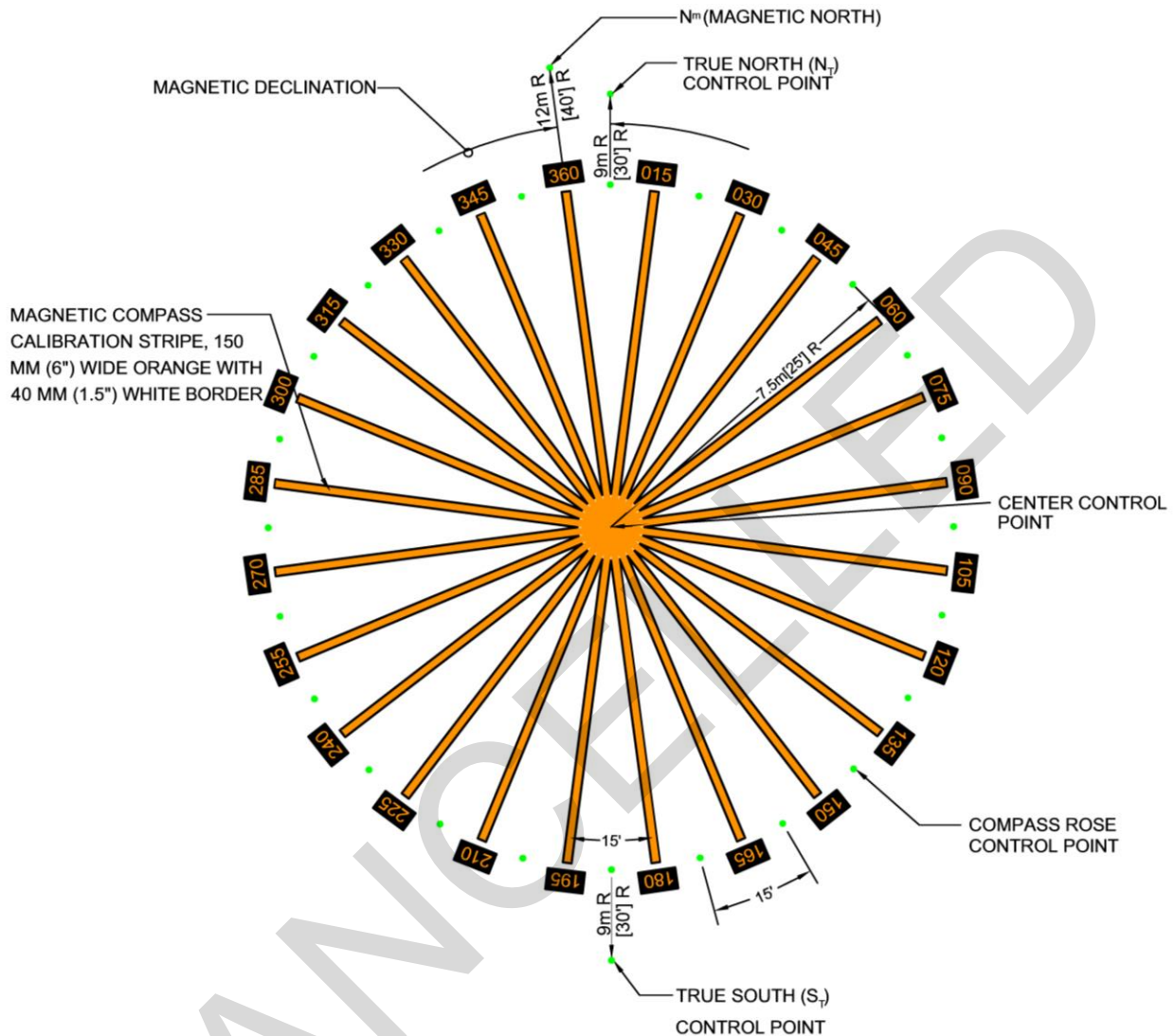

Figure B10-3. Type II Compass Rose Control Point and Marking Layout



**B10-9 CCP MARKINGS.**

**B10-9.1 Magnetic Compass Calibration Pad Type I Markings.**

Type I marking should be determined by the controlling aircraft technical manual (coordinate with aircraft maintenance group to determine specific requirements). The number of lines and locations of the lines relative to each other is determined by the number of compass systems and their installation location relative to the aircraft centerline. Some aircraft types may need only 1 line, others may need 3 lines. Typical

lines are 150-millimeter (6-inch) -wide orange stripes. These stripes begin at the center of the pad and extend outward for a minimum length of 7.5 meters (25 feet), aligned on the magnetic north and south control points. Border each stripe with a 40-millimeter (1.5-inch) -wide white stripe. Where Type I and Type II pads overlap, select line colors and layout to deconflict the markings as much as possible.

### **B10-9.2 Magnetic Compass Calibration Pad Type II Markings.**

Type II markings are set at magnetic directions from the corresponding true compass rose control point at every 15 degrees (15°). A 150-millimeter (6-inch) -wide orange stripe will be painted for each of the 24 compass rose control points. These stripes begin at the center of the pad and extend outward for a minimum length of 7.5 meters (25 feet). Border each stripe with a 40-millimeter (1.5-inch) -wide white stripe. At a distance of 8.2 meters (27 feet) from the center of the pad, identify the azimuth of each stripe as measured from magnetic north with 600-millimeter (24-inch) -high by 381-millimeter (15-inch) -wide orange block numerals. All azimuth numbers will contain 3 numerals (e.g., 045). The stroke of each numeral is a minimum of 90 millimeters (3.5 inches) wide. Each azimuth number will be painted on a solid white background formed from a rectangle 660 millimeters (26 inches) in height by 1,295 millimeters (51 inches) in width. The layout of the compass rose is detailed in Figure B10-3.

### **B10-9.3 Calibration Survey Data Markings.**

Mark the latest survey information on the CCP pavement using black letters on a white background as shown in Figure B10-4. Update the survey data after every re-calibration.

**Figure B10-4. Compass Calibration Pad Survey Data Marking**

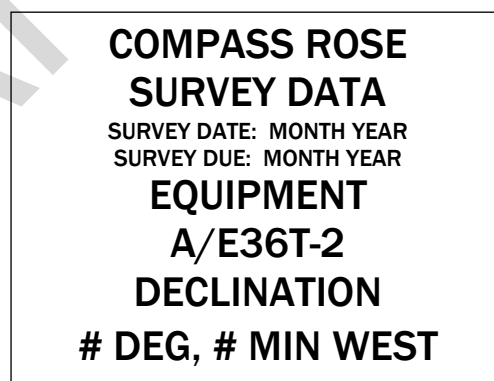

### **B10-10 SITING CONSIDERATIONS.**

#### **B10-10.1 Separation Distances.**

To meet the magnetically quiet zone requirements and prevent outside magnetic fields from influencing the aircraft compass calibration, all efforts possible will be taken to make sure the center of the pad meets the minimum separation distance guidelines.

The minimum recommended separation distances are as follows:

- 70 meters (230 feet) to underground metal conduits, metal piping (including reinforced concrete pipes), or similar items.
- 85 meters (280 feet) from the edge of any pavement that is not specifically designed and built for CCP operations.
- 150 meters (500 feet) to underground alternating current (AC) power lines (including runway/taxiway edge lighting).
- 185 meters (600 feet) to overhead steam lines; overhead conduits or metal piping; overhead AC power lines; any AC equipment; the nearest edge of any railroad track; the nearest fire hydrant; and the nearest portion of any building.
- 300 meters (1,000 feet) to any direct current (DC) power lines or equipment (including any underground or aboveground telephone lines).

**B10-10.2 Checking Site.**

Each proposed site for a CCP must be checked for magnetic influence to ensure the area is magnetically quiet, regardless of adherence to separation distances.

THIS PAGE INTENTIONALLY BLANK

CANCELLED



**APPENDIX B  
SECTION 11  
TIEDOWNS, MOORING, AND GROUNDING POINTS**

**B11-1 TYPES OF EQUIPMENT.**

**B11-1.1 Mooring and Grounding Point.**

A mooring and grounding point is a mooring casting with a grounding rod attached. Aircraft mooring and grounding points are used to secure parked aircraft and also serve as electrodes for grounding connectors for aircraft. Combined mooring and grounding points have previously been used by the Army but are not currently used as they do not meet mooring and grounding design loads required by TM 1-1500-250-23.

**B11-1.2 Mooring Point.**

A mooring point is a mooring casting without a grounding rod attached, used to secure parked aircraft. Mooring points are used by the Army.

**B11-1.3 Static Grounding Point.**

A static grounding point is a ground rod attached to a casting. The casting protects the ground rod but does not provide mooring capability. Static grounding points are used by the Army in aprons and hangars.

**B11-1.4 Static Ground.**

A static ground is a 3-meter (10-foot) rod with a closed-eye bend. The static ground is not intended to secure parked aircraft but may serve as an electrode connection for static grounding of aircraft. Static ground are installed at many Air Force installations.

**B11-1.5 Tiedown Mooring Eye.**

A tiedown mooring eye is a mooring casting with a grounding rod attached. They are similar to the mooring and grounding point discussed above. Tiedown mooring eyes are used by the Navy and Marine Corps.

**B11-2 MOORING POINTS FOR ARMY FIXED- AND ROTARY-WING AIRCRAFT.**

**B11-2.1 Type.**

A mooring point consists of a ductile iron casting, as shown in Figure B11-1. The mooring casting is an oval-shaped casting with a cross-rod to which mooring hooks are attached.

Figure B11-1. Army Mooring Point

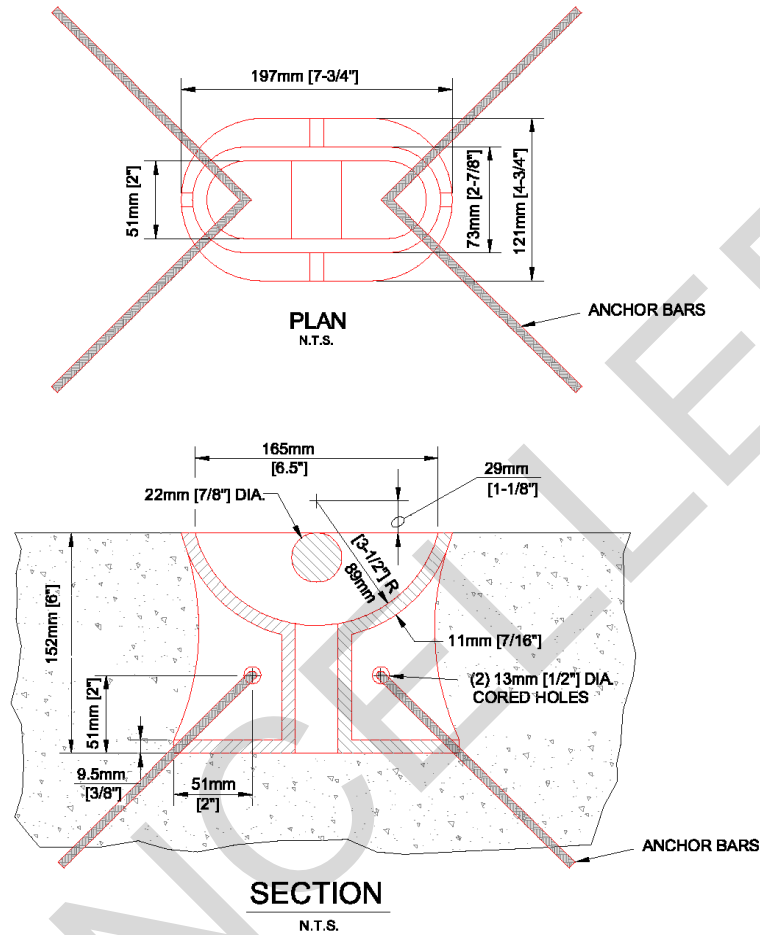

NOTES

1. MOORING DEVICE TO BE CAST IN DUCTILE IRON 80-55-06 OR EQUAL
2. ANCHOR RODS SHALL BE #3 DEFORMED REBAR, 380 mm (15") LONG AND BENT DOWNWARD AT 45 DEGREES. TWO ANCHOR BARS PER MOORING DEVICE.

## B11-2.2 Design Load.

Unless specifically waived in writing by the facility commander, all new construction of Army aircraft parking aprons will include aircraft mooring points designed for a 67,800-Newton (15,250-pound) load, as specified in TM 1-1500-250-23 and applied at 19.15 degrees (19.15°) from the pavement surface, as illustrated in Figure B11-2. Testing of new mooring point installations is not required; however, follow Figure B11-2 if testing is performed.

Figure B11-2. Army Load Testing of Mooring Points

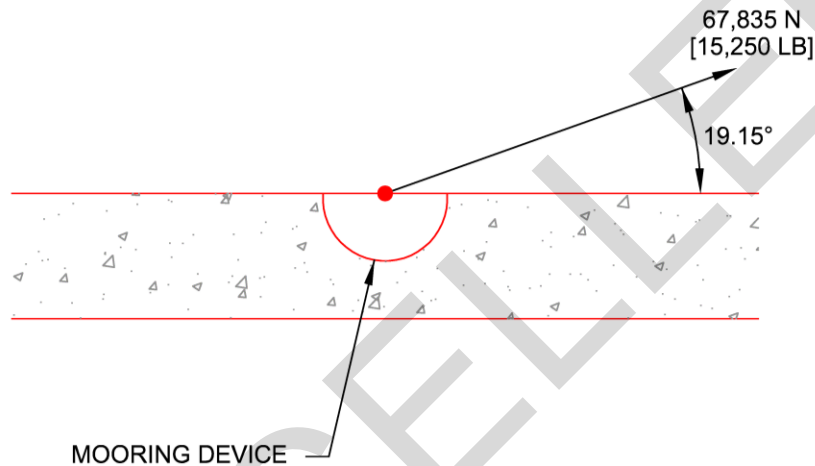

### NOTES

1. MOORING TESTS SHALL BE ACCOMPLISHED USING A HYDRAULIC RAM OR SIMILAR DEVICE AND AN APPROPRIATE REACTION (HEAVY VEHICLE, ETC.) THAT IS CAPABLE OF APPLYING A TENSILE LOAD OF 71,172 N [16,000 LB]
2. THE LENGTH OF MOORING CHAIN AND CONNECTING SHACKLE SHALL BE SELECTED IN SUCH A WAY THAT AN ANGLE OF 19.15° FROM THE PAVEMENT SURFACE (SEE ABOVE FIGURE) CAN BE MAINTAINED DURING LOAD TESTING.
3. APPROPRIATE SAFETY PRECAUTIONS SHALL BE TAKEN AT ALL TIMES DURING LOAD TESTING OPERATIONS.
4. THE MOORING POINTS SHALL BE LOADED IN 1,130 kg [2,500 LB] INCREMENTS UP TO 44,482 N [10,000 LB] AND IN 4,448 N [1000 LB] INCREMENTS UP TO 71,172 N [16,000 LB] WITH EACH LOAD INCREMENT HELD FOR AT LEAST 60 SECONDS.
5. TO PASS TEST REQUIREMENTS, MOORING POINTS SHALL NOT DEFORM PERMANENTLY UNDER 71,172 N [16,000 LB] LOAD.

## B11-2.3 Layout.

### B11-2.3.1 Fixed-Wing Aprons.

Mooring points should be located as recommended by the aircraft manufacturer or as required by the base.

**B11-2.3.2 Rotary-Wing Aprons.**

**B11-2.3.2.1 Number of Moored Parking Spaces.**

All exterior aircraft parking spaces will be provided with mooring points.

**B11-2.3.2.2 Number of Mooring Points at Each Parking Space.**

Each rotary-wing aircraft parking space location will have six mooring points. Although some rotary-wing aircraft only require four mooring points, six will be installed to provide greater flexibility for the types of rotary-wing aircraft that can be moored at each parking space. The largest diameter rotor blade of the facilities' assigned aircraft will be used for locating the mooring points within the parking space. The allowable spacing and layout of the six mooring points is illustrated in Figure B11-3. Parking space width and length dimensions are presented in Table 6-2 of Chapter 6.

**B11-2.3.2.3 Mooring Points on a Grid Pattern.**

A 6-meter by 6-meter [20-foot by 20-foot] mooring point grid pattern throughout the apron for mass aircraft parking aprons will not be authorized unless economically and operationally justified in writing by the installation commander. Figure B11-4 provides the recommended pavement joint and mooring point spacing should grid pattern mooring be utilized.

**B11-2.4 Installation.**

**B11-2.4.1 Mooring Points for New Rigid Pavement Equal to or Greater Than 150 Millimeters (6 Inches) Thick.**

Mooring points for new rigid pavements will be provided by embedding the mooring devices in fresh Portland cement concrete (PCC). The layout of points is shown in Figure B11-3 with mooring points at least 600 millimeters (2 feet) from the new pavement joints. This spacing will require close coordination between the parking plan and the jointing plan. Mooring points should be located a minimum of 600 millimeters (2 feet) from any pavement edge or joint and should provide proper cover for the reinforcing steel. Reinforcing bars should be placed around the mooring points as illustrated in Figure B11-5.

Figure B11-3. Army Rotary-Wing Allowable Mooring Point Spacing

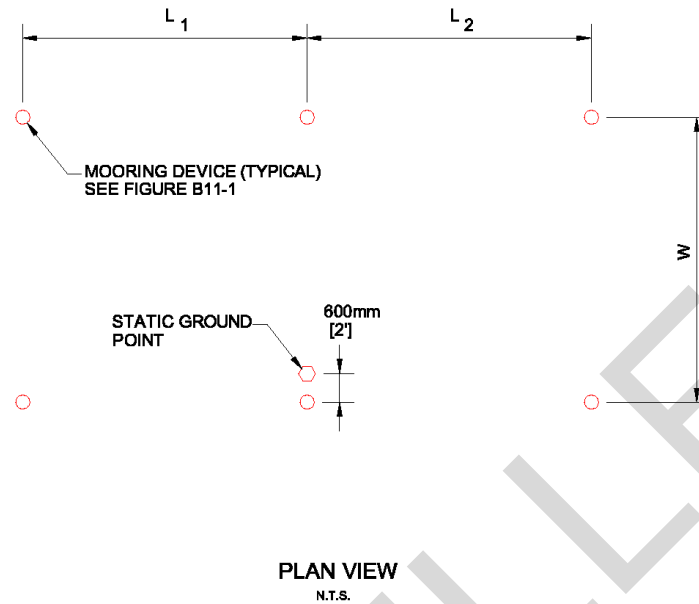

NOTES

1. THE PREFERRED MOORING POINT SPACING FOR EACH AIRCRAFT PARKING POSITION IS  $L_1=L_2=W = 6m [20.0']$
2. IN NEW OR EXISTING RIGID PAVEMENT, THE MOORING POINTS SHALL BE AT LEAST 600mm [2'] AWAY FROM ANY PAVEMENT JOINT OR EDGE. TO MISS THE PAVING JOINTS, THE SPACING OF THE MOORING POINTS MAY BE VARIED AS FOLLOWS:  
A.  $W, L_1$  AND  $L_2$  MAY VARY FROM 5 TO 6m [17 TO 20'].  
B.  $W, L_1$  AND  $L_2$  NEED NOT BE EQUAL.
3. THE CONSTRUCTION TOLERANCE ON MOORING POINT LOCATION SHALL BE 50mm [ $\pm 2'$ ]

Figure B11-4. Army Rotary-Wing Mooring Points Layout

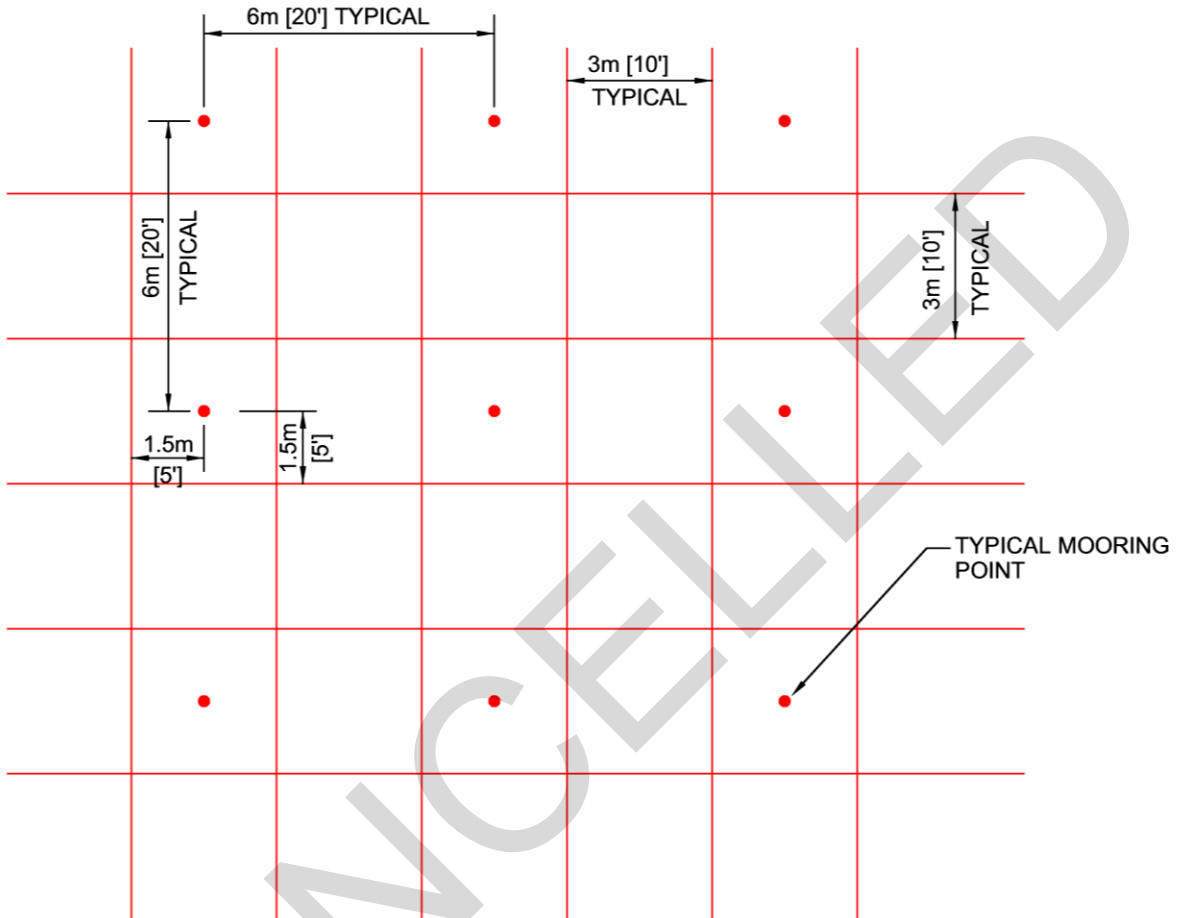

**NOTE**

THIS IS THE RECOMMENDED JOINT SPACING FOR NEW CONCRETE PAVEMENT WHERE MOORING DEVICES ARE JUSTIFIED AND AUTHORIZED THROUGHOUT THE APRON. OTHER JOINT SPACINGS MAY BE USED AS LONG AS MOORING DEVICES ARE SPACED AS SHOWN IN FIGURE B11-3.

Figure B11-5. Slab Reinforcement for Army Mooring Point

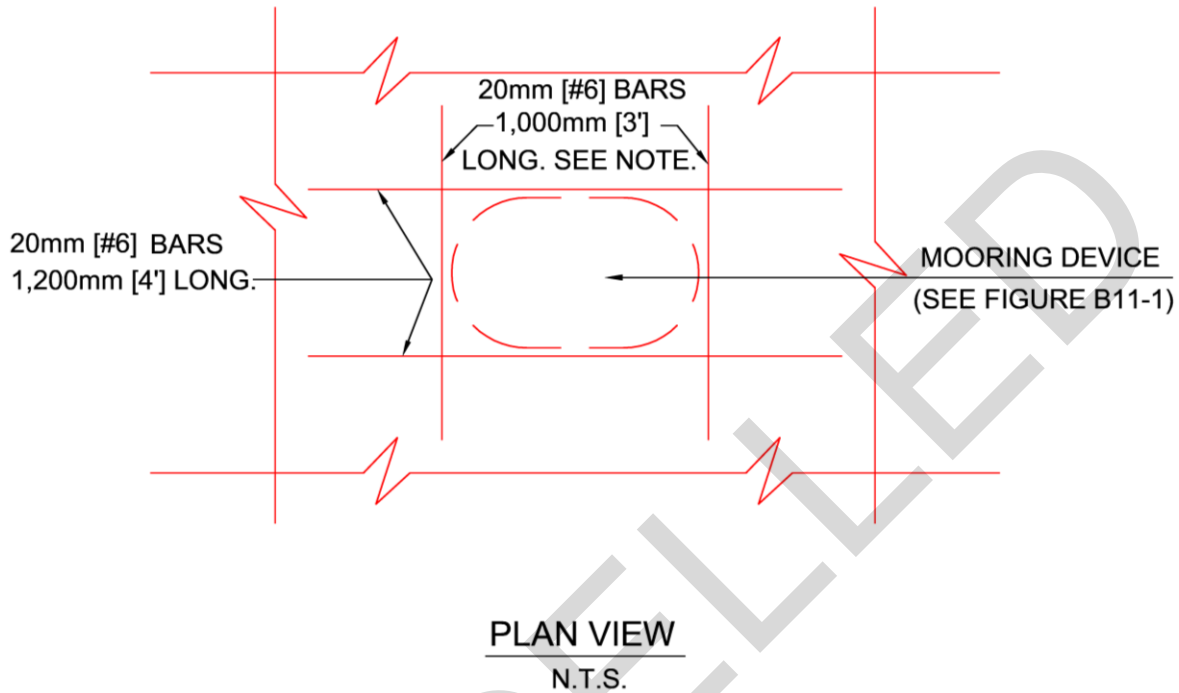

NOTES

1. #6 REINFORCING BARS SHALL BE PLACED 75mm [3"] FROM MOORING DEVICE AND 75mm [3"] BELOW PAVEMENT SURFACE.
2. ENDS OF REINFORCING BARS SHALL BE PLACED 75mm [3"] FROM PAVING JOINTS TO PROVIDE COVER.

**B11-2.4.2 Mooring Points for Existing Rigid Pavement Equal to or Greater Than 150 Millimeters (6 Inches) Thick and in Uncracked Condition.**

The following method should be used to provide mooring points for existing rigid pavement in an uncracked condition. The pavement should have only a few slabs with random cracks and must not exhibit "D" cracking. Mooring points should be provided by core-drilling a 300-millimeter (12-inch) -diameter hole through the pavement and installing a mooring point as illustrated in Figure B11-6.

**Figure B11-6. Mooring Point for Existing Rigid Pavement for Pavement Thickness Greater Than 150 Millimeters (6 Inches)**

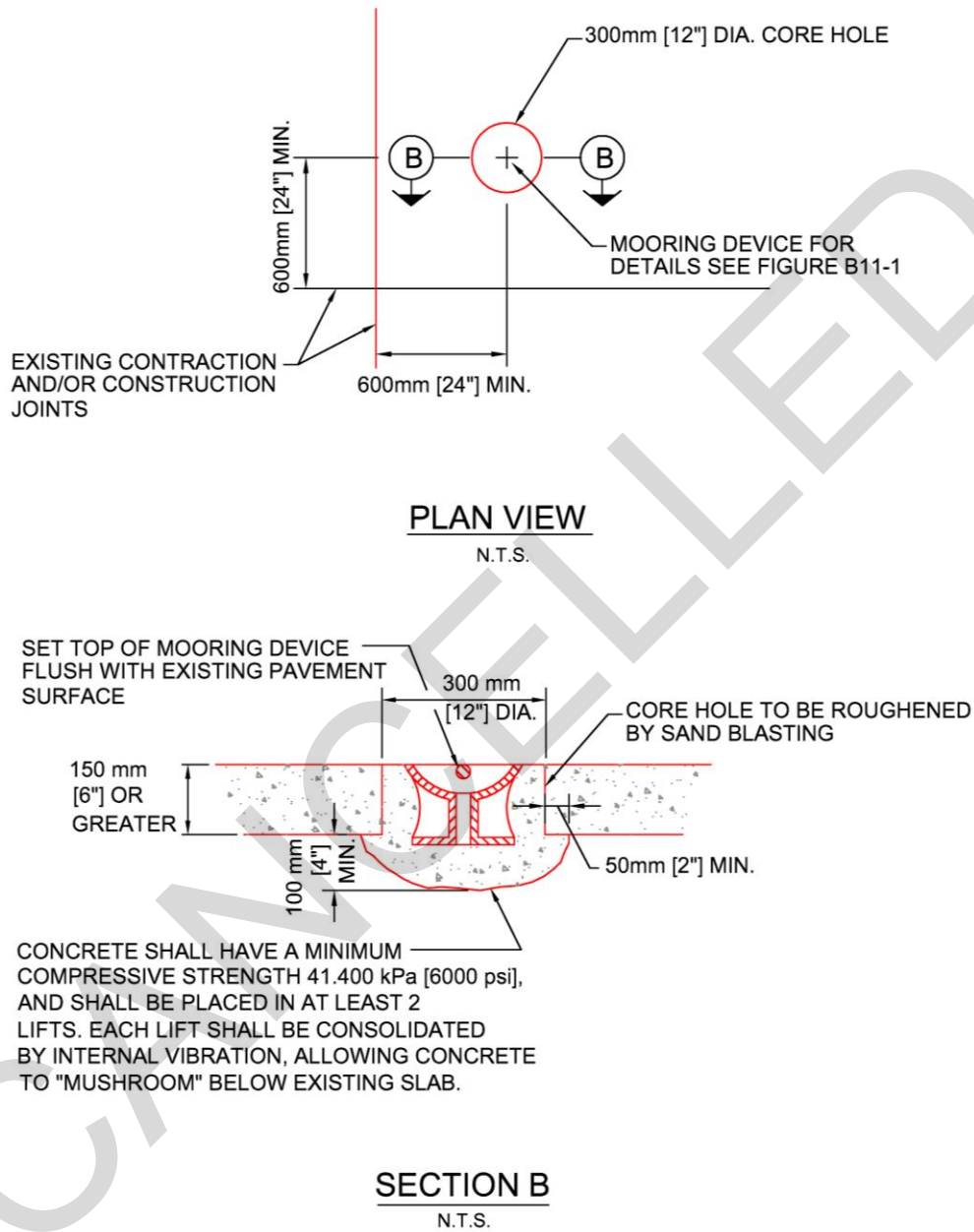

**NOTE**  
EXISTING CONCRETE SHOULD HAVE ONLY A FEW SLABS WITH CRACKS IF THIS OPTION IS TO BE USED.



### **B11-2.4.3 Mooring Points for Areas Not Covered Above.**

The following installation options should be used to provide mooring points for rotary-wing aircraft parked on the following pavements: existing rigid pavement less than 150 millimeters (6 inches) thick; existing rigid pavement in a cracked or deteriorated condition; new or existing flexible pavement; turfed areas; and other areas where appropriate.

#### **B11-2.4.3.1 Installation Option 1, Mooring Pad.**

This option is the preferred installation method and allows for placement of a new concrete pad with a minimum thickness of 200 millimeters (8 inches). The size of the pad should be a minimum of 7.3 meters (24 feet) wide by 13.4 meters (44 feet) long. The length and width may be increased to match the existing concrete joint pattern. The mooring pad, with six mooring points, is illustrated in Figure B11-7. The mooring devices should be installed as illustrated in Figure B11-1 and the concrete reinforced as illustrated in Figure B11-5.

#### **B11-2.4.3.2 Installation Option 2, Piers.**

This option allows the use of individual concrete piers for each mooring point, as shown in Figure B11-8. The diameter and length of the pier must be based on the strength of the soil, as presented in Table B11-1.

Figure B11-7. Army Rotary-Wing Mooring Pad Detail

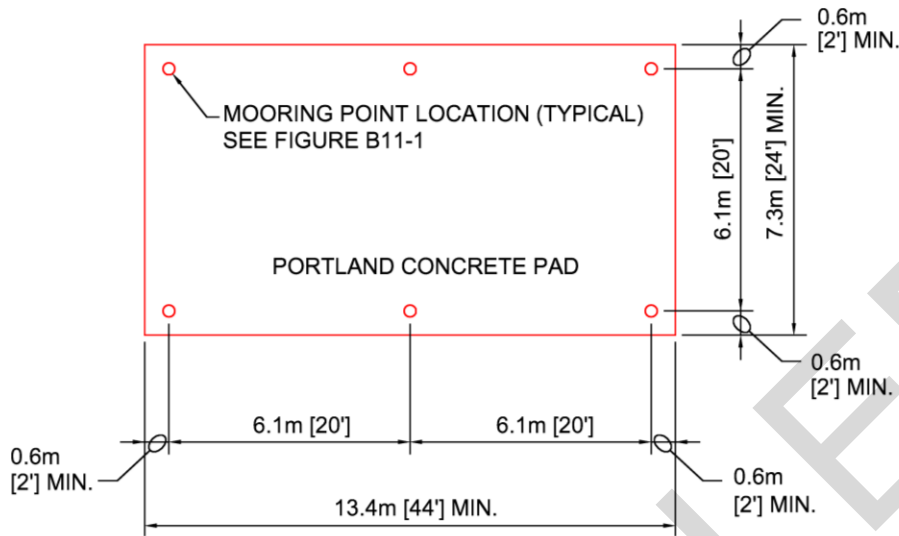

PLAN VIEW

N.T.S.

NOTES

1. THIS MOORING PAD IS THE PREFERRED METHOD OF PROVIDING MOORING POINTS IN GRASSED AREAS AND IN FLEXIBLE PAVEMENTS. FOR RIGID PAVEMENT APPLICATIONS, THE SIZE OF THE PAD SHOULD BE INCREASED TO MATCH THE EXISTING JOINT PATTERN.
2. THICKNESS OF THE PAD SHALL BE DESIGNED TO CARRY THE EXPECTED AIRCRAFT LOADS, BUT NOT LESS THAN 200mm [8"] THICK.
3. THE SLAB SHOULD BE DESIGNED AS A REINFORCED SLAB SO THAT PAVEMENT JOINTING WILL NOT BE REQUIRED. IF JOINTED PAVEMENT IS DESIRED, JOINT SPACING SHOULD BE ADJUSTED SO THAT MOORING POINTS ARE A MINIMUM OF 0.6m [2'] FROM PAVEMENT JOINTS.
4. SEE FIGURE B11-6 FOR REINFORCING ADJACENT TO MOORING DEVICE.
5. TYPICAL PREFERRED SPACING BETWEEN MOORING DEVICES IS 6.1m [20']. SEE FIGURE B11-3 FOR ALLOWABLE MOORING AND STATIC GROUND POINT SPACING.

Figure B11-8. Army Mooring Point for Grassed Areas, Flexible Pavement, or Rigid Pavement - Thickness Less Than 150 millimeters (6 inches)

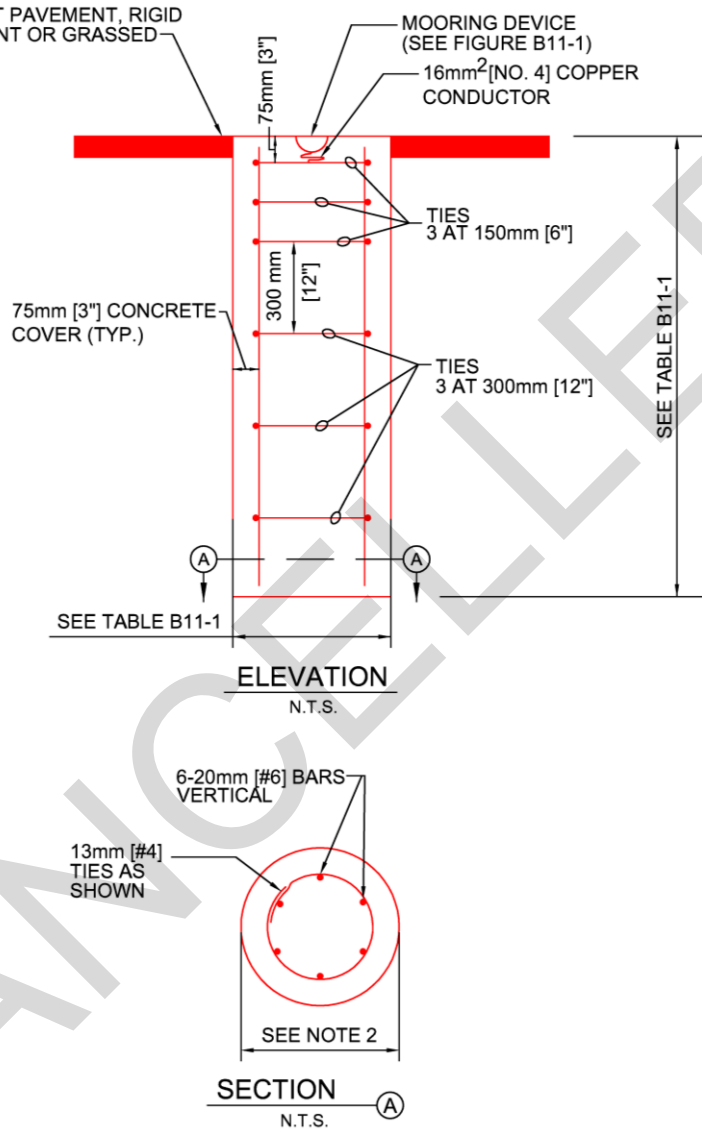

NOTES

1. CORE DRILL ASPHALT PAVEMENT. FOR PIER LENGTH AND DIAMETER, SEE TABLE B11-1
2. SPIRAL REINFORCEMENT EQUIVALENT TO THE 13mm [#4] TIES MAY BE USED.
3. SEE FIGURE B11-3 FOR ALLOWABLE MOORING AND STATIC GROUND POINT SPACING

**Table B11-1. Army Pier Length and Depths for Tiedowns**

<b>Cohesive Soils</b>				
Unconfined Compressive Strength ( $q_u$ in kg/m <sup>2</sup> [lb/ft <sup>2</sup> ])	Pier Diameter		Pier Length	
	m	ft	m	ft
$q_u < 5,000$ kg/m <sup>2</sup> ( $q_u < 1,000$ lb/ft <sup>2</sup> )	600 mm	2.0 ft	1,800 mm	6.0 ft
$5,000 < q_u < 19,500$ kg/m <sup>2</sup> ( $1,000 < q_u < 4,000$ lb/ft <sup>2</sup> )	500 mm	1.5 ft	1,800 mm	6.0 ft
$q_u > 18,500$ kg/m <sup>2</sup> ( $q_u > 4,000$ lb/ft <sup>2</sup> )	500 mm	1.5 ft	1,200 mm	4.0 ft
<b>Cohesionless Soils</b>				
Friction Angle $\phi$ in Degrees	Pier Diameter		Pier Length	
	m	ft	m	ft
$\phi < 20^\circ$	600 mm	2.0 ft	2,100 mm	7.0 ft
$20^\circ \leq \phi \leq 30^\circ$	600 mm	2.0 ft	1,800 mm	6.0 ft
$\phi > 30^\circ$	500 mm	1.5 ft	1,800 mm	6.0 ft

**B11-3 EXISTING MOORING POINTS FOR ARMY.**

Existing mooring points will be tested for structural integrity and strength as detailed in Figure B11-2. If the existing mooring fails to meet the structural requirements listed herein, replacement of the mooring structure is required. If the existing mooring point has an attached ground rod, its electrical resistance value must be measured. If it fails to meet resistivity requirements, a new static ground rod is required.

**B11-3.1 Evaluation of Existing Mooring Points for Structural Adequacy.**

**B11-3.1.1 Adequate Mooring Points.**

Existing 19-millimeter (0.75-inch) -diameter bimetallic, copper-covered steel rods, 1,800 millimeters (6 feet) long are considered adequate for immediate aircraft protection, provided the following conditions are met:

- The existing rods are installed in rigid pavement.
- The existing rods do not show signs of deformation or corrosion.
- The existing rods are inspected for deformation and corrosion at least once a year and after each storm event with winds greater than 90 kilometers per hour (50 knots).

**B11-3.1.2 Inadequate Mooring Points.**

At Army facilities, any existing rods that exhibit deformation or corrosion will be considered inadequate and require replacement. All existing 19-millimeter (0.75-inch) - diameter, 1,800-millimeter (6-foot) -long rods in flexible (asphalt) pavement, including those with a Portland cement concrete (PCC) block at the surface, require replacement.

**B11-3.2 Evaluation of Existing Mooring Points for Resistance.**

The maximum resistance measured, in accordance with IEEE Standard 142, of existing grounding points, will not exceed 10,000 ohms under normally dry conditions. If this resistance cannot be obtained, an alternative grounding system will be designed.

**B11-4 STATIC GROUNDING POINTS FOR ARMY AND AIR FORCE FIXED- AND ROTARY-WING FACILITIES.**

See UFC 3-575-01 for static ground requirements. One static ground point shall be provided at each rotary-wing parking position, as shown in Figure B11-9.

CANCELLED

Figure B11-9. Mooring and Ground Point Layout for Rotary-Wing Parking Space

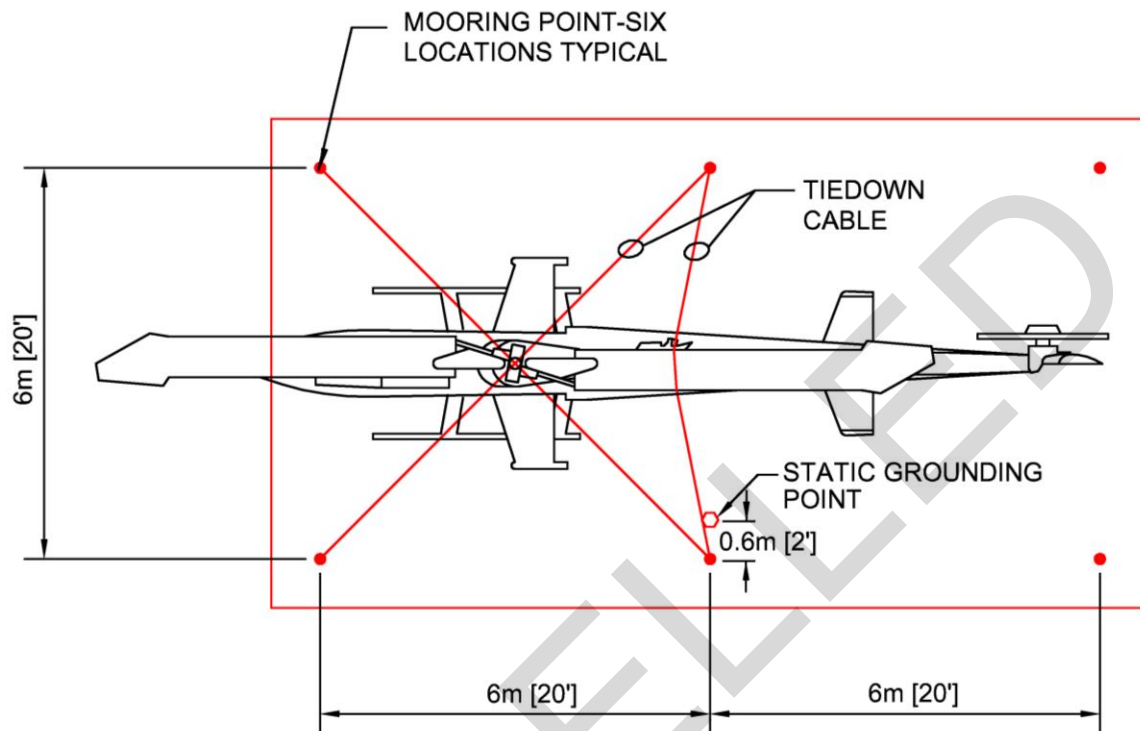

## B11-5 AIR FORCE TIEDOWNS.

### B11-5.1 General.

For the Air Force, tiedowns will be constructed in accordance with Figures B11-11 and B11-12 and may be used as a static ground provided they meet the requirements given in UFC 3-575-01. For maximum flexibility, they may be installed in 4.6-meter (15-foot), 6.1-meter (20-foot), or 9.1-meter (30-foot) grids, or offset grids. At minimum, place tiedowns as indicated in aircraft Technical Orders or Facility Requirements Documents. Ideally, tiedowns will be centered in slabs, but, at minimum, shall not be located less than 914 millimeters (3 feet) from any joint.

- B11-5.1.1 If tiedowns are intended to also be used as static grounds, soil conditions may require that a ground rod be installed. When a ground rod is included, bond it to the tiedown bar.
- B11-5.1.2 See UFC 3-575-01 for static ground requirements.

### B11-5.2 Layout.

Tiedowns shall be configured and spaced in accordance with the requirements of the mission aircraft and will vary from aircraft to aircraft. An example of a multiple fixed-wing aircraft tiedown layout is shown in Figure B11-10.

**Figure B11-10. Example of Air Force Multiple Tiedown Layout for Fixed-Wing Aircraft**

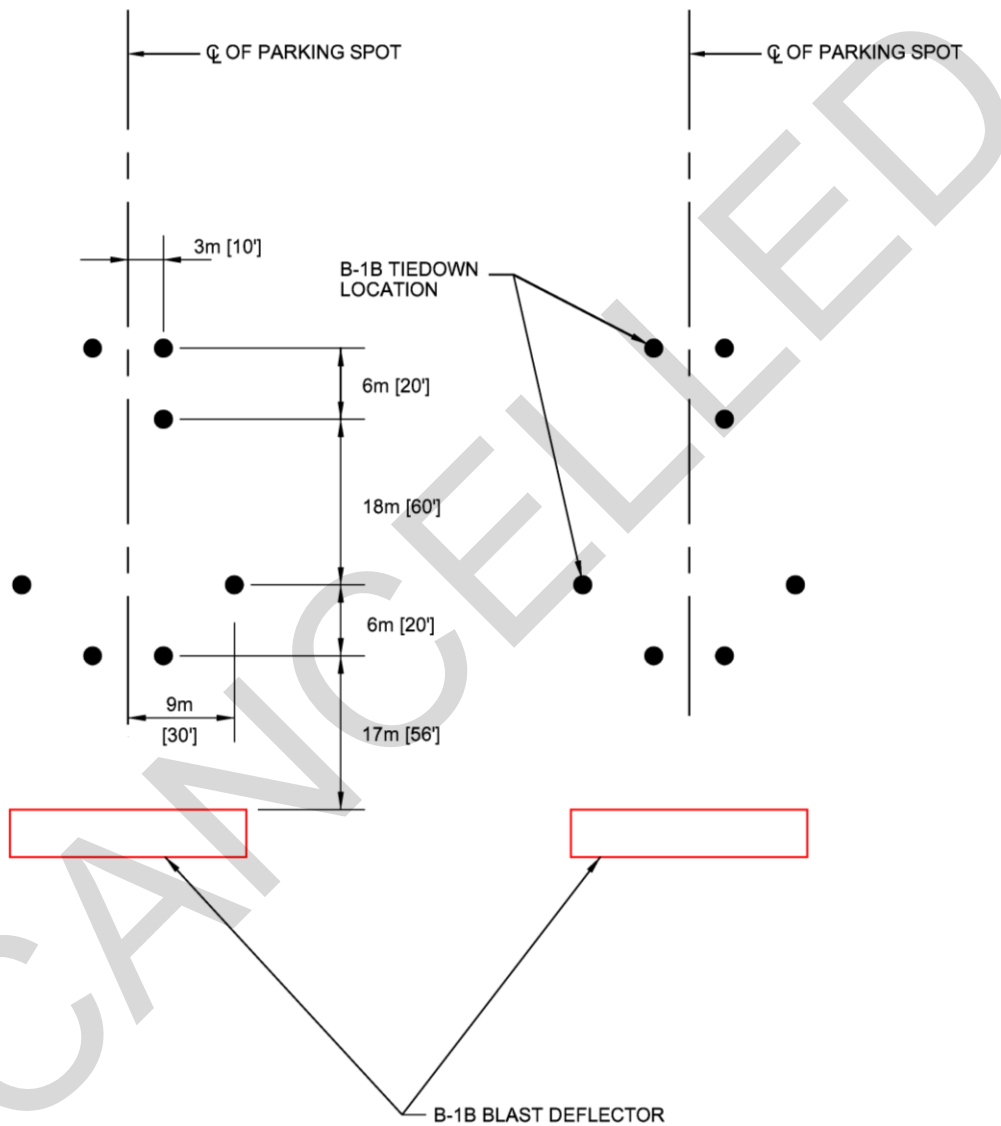

**NOTE:**  
THIS IS AN EXAMPLE FOR ONE AIRCRAFT (B-1B).  
FOR SPECIFIC AIRCRAFT DIMENSIONS REFERENCE  
THE AIRCRAFT TECHNICAL ORDER (T.O.)  
(AVAILABLE FROM MAINTENANCE ASSISTANCE  
PROGRAM OFFICE).

**B11-5.3 Installation.**

**B11-5.3.1 Pavement Recess Design.**

The top of the static ground will be set at pavement grade or not more than 6 millimeters (0.25 inch) below grade. A smooth, rounded-edge recess 75 millimeters (3 inches) wide and not more than 150 millimeters (6 inches) long will be provided in the pavement around the eye for accessibility and attachment of grounding cables. This is shown in Figure B11-12.

**Figure B11-11. Air Force Aircraft Tiedown, Profile**

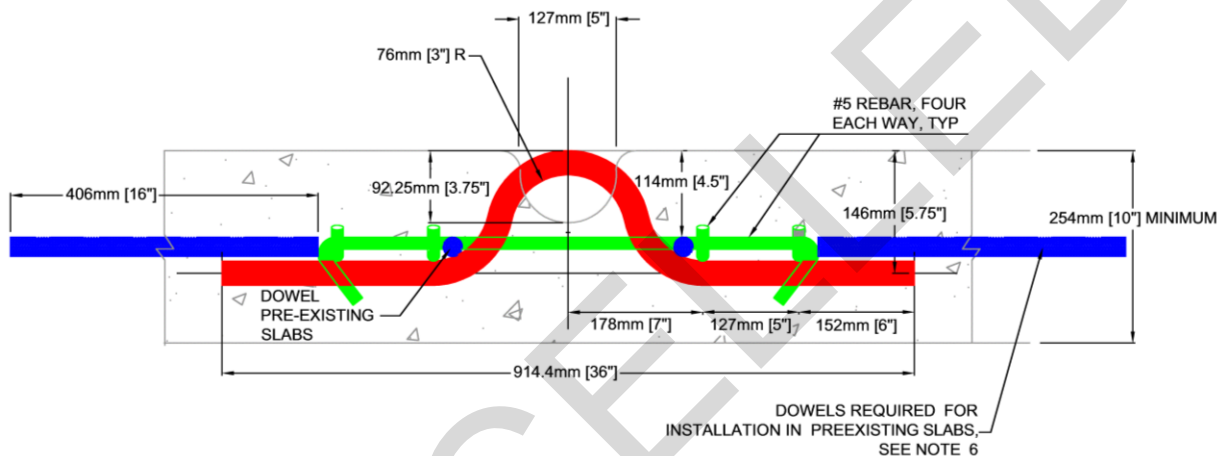

**NOTES:**

1. PLACE TIE DOWNS AS INDICATED IN AIRCRAFT TECHNICAL ORDER OR FACILITY REQUIREMENTS DOCUMENT. IF THE TIEDOWN IS INTENDED TO ALSO BE USED AS A STATIC GROUND, SOIL CONDITIONS MAY REQUIRE THAT A GROUND ROD BE INSTALLED. WHEN A GROUND ROD IS INCLUDED, BOND IT TO THE TIEDOWN BAR.
2. MINIMUM DISTANCE FROM TIEDOWN CENTER POINT TO AN UNDOWELED JOINT IS 914 mm (3'). WHEN TIE DOWNS OCCUR 914mm [3'] FROM A SINGLE JOINT, ORIENT BAR PARALLEL WITH THE JOINT. IF CENTER POINT OCCURS 914mm (3') FROM ADJACENT JOINTS, ORIENT BAR PARALLEL WITH EITHER JOINT.
3. BAR WILL BE NUMBER 7 (0.875") NON-DEFORMED AISI 8620H STEEL.
4. MINIMUM SLAB THICKNESS IS 254mm [10"].
5. PIER DIMENSIONS FOR ASPHALT PAVEMENTS MUST BE DESIGNED TO ACCOMMODATE ANTICIPATED UPLIFT FORCES. FOR 17,100 kg (37,700 LBS) MINIMUM PIER DIMENSIONS ARE 1.83m x 1.83m x 2.13m (6' x 6' x 7').
6. FOR INSTALLATION IN PREEXISTING SLABS, INSTALL 1" Ø x 16" DOWEL RODS CENTERED AT HALF SLAB DEPTH, ALL FOUR SIDES AS SHOWN IN THE PLAN VIEW. MINIMUM ANCHOR BLOCK DIMENSIONS IN THIS CASE ARE 254mm [10"] x 1,067mm [42"] x 1,067mm [42"].



Figure B11-12. Air Force Aircraft Tiedown, Plan

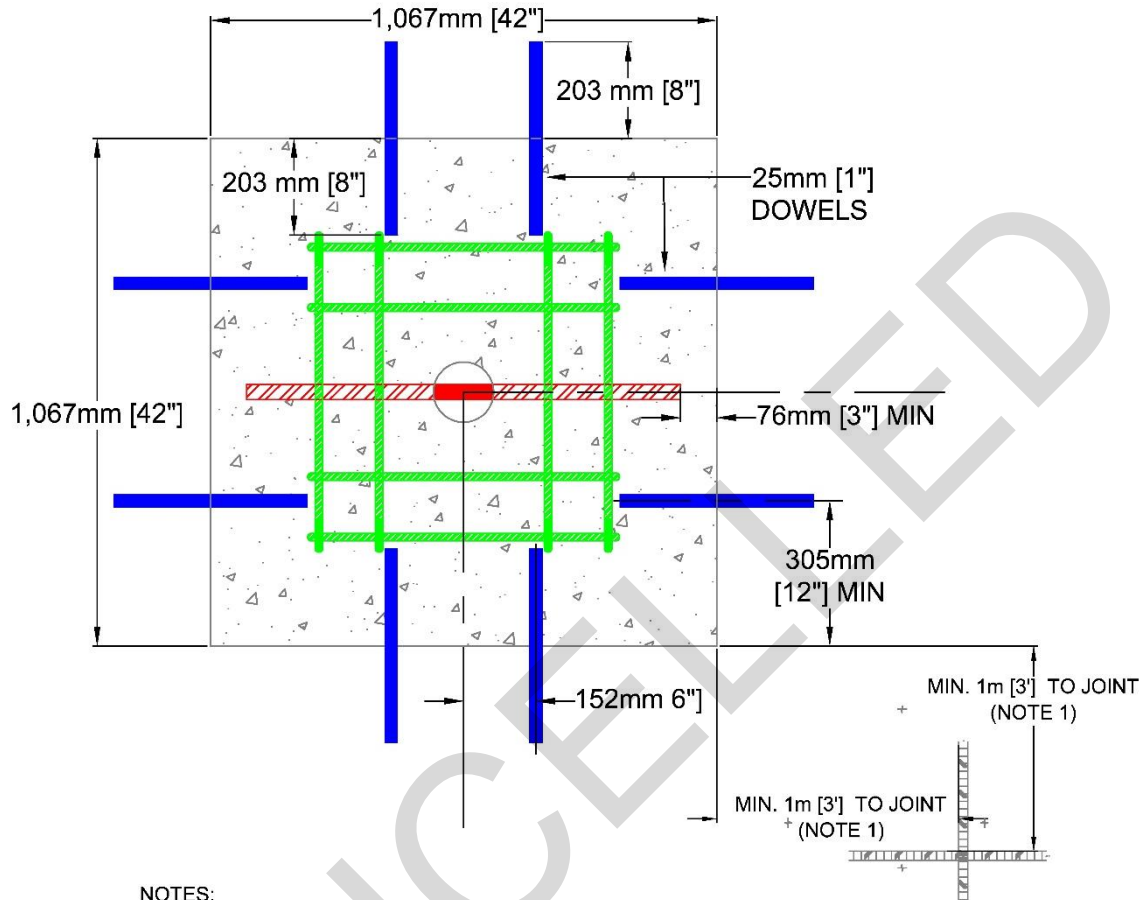

### B11-6 TIEDOWN MOORING EYES FOR NAVY AND MARINE CORPS.

Requirements, layout, and installation details for Navy and Marine Corps tiedown mooring eyes are found in Figures B11-13, B11-14 and B11-15. Requirements, layout, and installation details for Navy and Marine Corps grounding arrangements are found in UFC 3-575-01. A tiedown mooring eye must be placed at the center of every parking apron slab. For PCC with a thickness greater or equal to 254 mm (10"), the allowable uplift capacity of a T-56 tiedown is 167,698 Newtons (37,700 lbs). For PCC with a thickness greater or equal to 178 mm (7"), but less than 254 mm (10"), the allowable uplift capacity of a T-56 tiedown is 111,206 Newtons (25,000 lbs). These allowable uplift capacities assume a minimum of 40% load transfer efficiency across all doweled and non-doweled joints.

Figure B11-13. Navy and Marine Corps T-56 Mooring Eye/Tiedown Detail

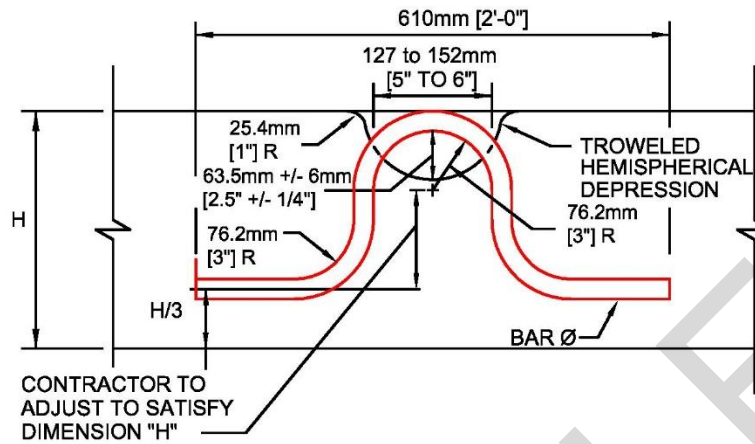

**TIEDOWN/MOORING EYE-TYPE A**

NOT TO SCALE

**NOTES**

1. PLACE MOORING EYES AS INDICATED ON PLANS.
2. WHEN REBAR FOR EYE OCCURS WITHIN 610mm (2') OF JOINT, ORIENT REBAR PARALLEL TO JOINT.
3. BAR MUST BE 23MM ( $\frac{7}{8}$ ") NON-DEFORMED AISI 8620H STEEL (SINGLE QUENCHED AND TEMPERED (230° C (450° F)), CARBURIZED).

Figure B11-14. Navy and Marine Corps T-56 Retrofit Detail Option 1

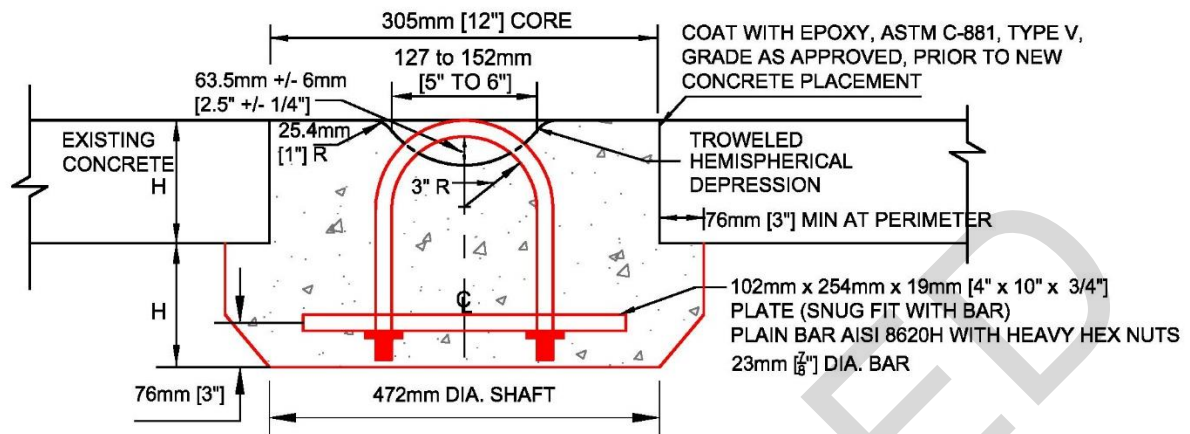

## TIEDOWN/MOORING EYE (RETROFIT) DETAIL

NOT TO SCALE

### NOTES

1. PLACE MOORING EYES AS INDICATED ON PLANS.
2. DO NOT PLACE MOORING EYE WITHIN 1M [3'] OF ANY CRACK OR JOINT.
3. TIEDOWNS MUST NOT BE PLACED WITHIN 1M (3') OF ANY CONTRACTION OR CONSTRUCTION JOINT AND MUST BE ORIENTED PARALLEL TO NEAREST JOINT.
4. BAR MUST BE 23MM (7/8") NON-DEFORMED AISI 8620H STEEL (SINGLE QUENCHED AND TEMPERED (230° C (450° F)), CARBURIZED).

### SEQUENCE

1. CORE PAVEMENT.
2. EXTEND SHAFT TO A MINIMUM DEPTH AND 76mm [3"] MINIMUM UNDERCUT SHOWN.
3. MAINTAIN SHAFT UNTIL PCC PLACEMENT.
4. PLACE BAR ASSEMBLY AND NEW CONCRETE (4,000 PSI MIN).

Figure B11-15. Navy and Marine Corps T-56 Retrofit Detail Option 2

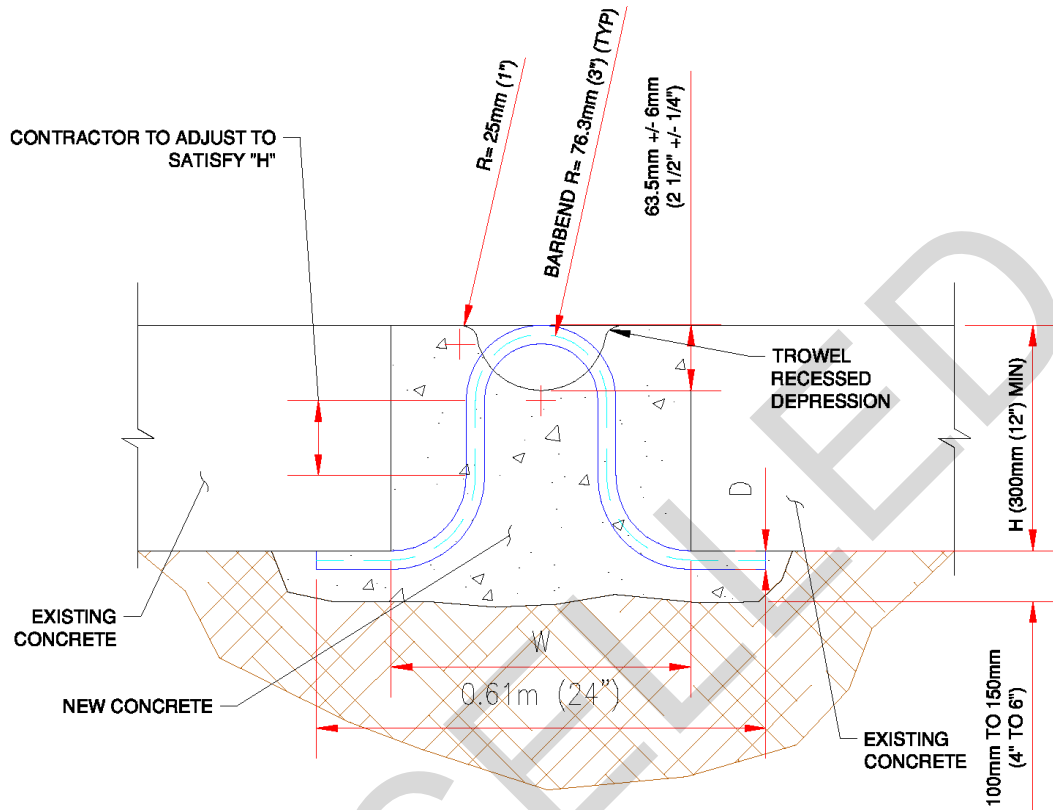

#### NOTES

1. THIS DETAIL IS NOT INTENDED FOR USE IN PAVEMENTS LESS THAN 300mm (12") THICK.
2. SAWCUT EXISTING CONCRETE. DIMENSIONS OF SAWCUT SHALL BE 300mm (12") WIDE ("W") BY 685mm (27") LONG.
3. EXCAVATE 100mm to 150 mm (4" TO 6") BELOW BASE OF SLAB WITH HAND TOOLS AS REQUIRED TO ROTATE HAT-SHAPED BAR 90 DEGREES.
4. PLACE HAT SHAPED BAR INTO HOLE.
5. ROTATE HAT-SHAPED BAR 90 DEGREES.
6. SUSPEND TOP OF HAT-SHAPED BAR SO THAT THE TOP OF BAR IS RECESSED APPROXIMATELY 6mm (1/4") BELOW TOP OF CONCRETE SLAB.
7. PLACE CONCRETE AND HAND TROWEL RECESSED DEPRESSION.
8. BAR MUST BE 23mm (7/8") NON-DEFORMED AISI 8620H STEEL (SINGLE QUENCHED AND TEMPERED (230° C (450° F)), CARBURIZED).
9. TIEDOWNS MUST NOT BE PLACED WITHIN 1m (3') OF ANY CONTRACTION OR CONSTRUCTION JOINT AND MUST BE ORIENTED PARALLEL TO NEAREST JOINT.

THIS PAGE INTENTIONALLY BLANK

**APPENDIX B  
SECTION 12  
JET ENGINE THRUST STANDOFF REQUIREMENTS FOR AIRFIELD ASPHALT  
EDGE PAVEMENTS**

**B12-1 PURPOSE.**

This section presents the standoff distances from jet aircraft during engine run-up required to prevent uplift forces from causing catastrophic failure of asphalt edge pavements. This Section supersedes ETL 07-3, *Jet Engine Thrust Standoff Requirements for Airfield Asphalt Edge Pavements*.

**B12-2 APPLICATION.**

The requirements of this section are mandatory for Air Force Installations.

**B12-2.1 Authority.**

Air Force policy directive (AFPD) 32-10, *Air Force Installations and Facilities*, and Air Force instruction (AFI) 32-1023, *Design and Construction Standards and Execution of Facility Construction Projects*.

**B12-2.2 Intended Users.**

- Air Force MAJCOM engineers.
- Base Civil Engineers (BCE), RED HORSE (Rapid Engineers Deployable - Heavy Operations Repair Squadron Engineers) squadrons, and other units responsible for design, construction, maintenance, and repair of airfield pavements.
- U.S. Army Corps of Engineers (USACE) and Navy offices responsible for Air Force design and construction.

**B12-2.3 Referenced Publications.**

**B12-2.3.1 Air Force.**

- AFPD 32-10, *Air Force Installations and Facilities*, available at <http://www.e-publishing.af.mil/2>
- AFI 32-1023, *Designing and Constructing Military Projects*
- AFI 32-1042, *Standards for Marking Airfields*, available at <http://www.e-publishing.af.mil/>

**B12-2.3.2 Army.**

- USACE TSC Report 13-2 *Aircraft Characteristics for Airfield Pavement Design and Evaluation*, May 2015, available at

<https://transportation.wes.army.mil/tsmcx/criteria.aspx> (CAC required for access).

**B12-2.3.3 Joint.**

- Unified Facilities Criteria 3-260-04, *Airfield Pavement Markings*.

**B12-2.3.4 Industry.**

- Boeing Document D6-58329 Rev C, 777 200/300 Airplane Characteristics for Airport Planning, July 2002, available at <http://www.boeing.com/commercial/airports/777.htm>

**B12-2.4 Background.**

Catastrophic failure of airfield edge pavement due to uplift forces from jet engine thrust has occurred at multiple locations, resulting in damage to aircraft, vehicles, and real property. The criteria in this Section are being issued due to tangible life safety and financial concerns. This phenomenon has been observed and studied in the past. In 1988, the Air Force Engineering and Services Center (AFESC) responded to MAJCOMs' requests for engineering data on this subject by providing safe standoff distances to edge pavements for numerous aircraft. This Section encompasses and updates previous guidance.

**B12-2.5 Analysis.**

Past guidance was based on both mechanistic air velocity–air pressure relationships, as defined by the Bernoulli equation, and empirical observation. Based on the following Bernoulli model, the critical air velocity would be limited to 218 kilometers per hour (kph) (136 miles per hour [mph] or 199.8 feet per second [fps])

$$V = \sqrt{\frac{2g\Delta p}{\rho}}$$

$$\rho = \frac{p}{RT}$$

where:

- $V$  = velocity
- $\Delta p$  = 1197 pascals (25 pounds per square foot [psf]) (51-millimeter [2-inch] thick asphalt mass)
- $g$  = 9.81 meters (32.2 feet) per second•second

- $\rho$  = 101.3 kilopascals (14.7 pounds per square inch absolute [psia]) at sea level
- $R$  = 53.3 (ft-lb/lb) / °Rankine (°R) (gas constant, air)
- $T$  = 985 °R (typical exhaust temperature at expected velocity and distance of interest)

However, empirical observation has indicated that the typical 51-millimeter (2-inch)-thick edge pavement can withstand velocities up to 362 kph (225 mph). This higher observed velocity was accepted as a valid basis for criteria development because the simple Bernoulli model ignored other forces which are difficult to model, such as friction, shear, and adhesion. Without being able to further refine the mechanistic model, guidance was issued based on empirical observations, with a safety factor of two applied. The active uplift force is a function of the velocity squared. Dividing the observed velocity of 362 kph (225 mph) by the square root of this safety factor yielded a threshold velocity of 257 kph (160 mph). This velocity was issued as criteria for establishing standoff distances.

**B12-2.6 Standoff Distances.**

Aircraft should be positioned so that jet blast velocities are below 257 kph (160 mph) at the edge of a typical 51-mm (2-in) -thick asphalt shoulder pavement. Table B12-1 lists the standoff distance aft of the aircraft tail where data indicates the engine exhaust velocity is reduced to 257 kph (160 mph). Where data indicates that the actual velocity would be lower than this threshold velocity value, a minimum standoff distance of 8 meters (m) (25 feet [ft]) is recommended. In locations where the Aircraft Tail Standoff Distance cannot be met, increasing the asphalt thickness can counteract the uplift force caused by jet blast; however, asphalt lifts must be well-bonded to each other and free of cracking to ensure jet blast cannot separate the top lift from the underlying lift(s).

**Table B12-1. Safe Standoff Distances Aft of Aircraft Tail (Based on 51-mm [2-in] Asphalt Shoulder Pavement Thickness)**

<b>Table B12-1. Safe Standoff Distances Aft of Aircraft Tail</b>			
<b>Aircraft</b>	<b>Aircraft Tail Standoff Distance</b>	<b>Jet Blast Velocity Data Source</b>	<b>Remarks</b>
B-1B	88 m (290 ft)	ETL 1110-3-394	
B-52H	8 m (25 ft)	ETL 1110-3-394	See Note 3
C-5A/B	23 m (75 ft)	ETL 1110-3-394	
C-9A	20 m (65 ft)	ETL 1110-3-394	
C-17	18m (60 ft)	ETL 1110-3-394	
C-20B	18m (60 ft)	ETL 1110-3-394	See Note 6

Table B12-1. Safe Standoff Distances Aft of Aircraft Tail			
Aircraft	Aircraft Tail Standoff Distance	Jet Blast Velocity Data Source	Remarks
C-21A	9 m (30 ft)	ETL 1110-3-394	
C-32 (Boeing 757-200)	55 m (180 ft)	ETL 1110-3-394	
C-37A	18 m (60 ft)	ETL 1110-3-394	See Note 6
C-40 (Boeing 737-700)	26 m (85 ft)	Boeing	
C-130	8 m (25 ft)	ETL 1110-3-394	See Note 3
KC-10	61 m (200 ft)	ETL 1110-3-394	3 engines
KC-135E/R EC-135A/G/L RC-135	32 m (105 ft)	ETL 1110-3-394	
KC-46	43 m (140 ft)	Boeing FRD	
VC-25A (Boeing 747-200)	26 m (85 ft)	Boeing	
F-15E	43 m (140 ft)	ETL 13-2	
F-16C/D	55 m (180 ft)	ETL 13-2	
F-22			
F-35A	71 m (232 ft)	FRD	
F-35B			
F-35C	71 m (232 ft)	FRD	
Boeing 707	35 m (115 ft)	Boeing	
Boeing 727	34 m (110 ft)	Boeing	
Boeing 737	26 m (85 ft)	Boeing	
Boeing 747	35 m (115 ft)	Boeing	
Boeing 757	49 m (160 ft)	Boeing	
Boeing 767	46 m (150 ft)	Boeing	
Boeing 777	94 m (310 ft)	Boeing	
DC-9	23 m (75 ft)	Boeing	
DC-10	73 m (240 ft)	Boeing	
MD-80	37 m (120 ft)	Boeing	



Table B12-1. Safe Standoff Distances Aft of Aircraft Tail			
Aircraft	Aircraft Tail Standoff Distance	Jet Blast Velocity Data Source	Remarks
Airbus A300F4-600	30 m (100 ft)	Airbus	
Airbus A318-100	12 m (40 ft)	Airbus	
Airbus A319	8 m (25 ft)	Airbus	See Note 3
Airbus A320	26 m (85 ft)	Airbus	
Airbus A321	8 m (25 ft)	Airbus	See Note 3
Airbus A330	76 m (250 ft)	Airbus	
Airbus A340	No jet blast data available for >102 mph		
Airbus A380	107 m (305 ft)	Airbus	
AN-124	No jet blast data available		
IL-76	No jet blast data available		

**NOTES**

1. If the design aircraft is not listed in Table B12-1, bases should contact their MAJCOM pavement engineer for additional guidance.
2. The information listed in the table is derived from the best information available at the time of publication. However, aircraft models and engines can change, resulting in changes to jet blast characteristics. Therefore, when designing or evaluating a site for a particular aircraft, always check for updated jet blast characteristics.
3. Data indicates jet blast velocities are less than 257 kph (160 mph) at the back of the aircraft tail. In such instances, it is recommended that a minimum 8 m (25 ft) standoff should be applied.
4. All reported distances are for maximum or takeoff engine power settings.
5. Where no specific aircraft model is listed, listed standoff distance is for the aircraft model with highest jet blast velocity.
6. Standoff distance is based on Gulfstream II jet blast data.

**B12-2.7 Run-Up Pad Design.**

When designing new or checking existing engine run-up pads, the following criteria should be applied:

- New and existing run-up pads should be designed/modified to provide the full standoff distance behind the tail of the aircraft, as listed in Table B12-1.
- When it is not possible or practical to meet the distances listed in Table B12-1, then a minimum 8 m (25 ft) of Portland cement concrete (PCC) pavement must be provided between the tail of the aircraft and the edge of the apron. However, be aware that damage to the asphalt shoulder pavement can be expected. To mitigate damage, PCC may be constructed in lieu of asphalt in the areas affected by jet blast.

- Consideration must be given to other objects in the jet blast wake (e.g., roads, parking lots, hangars, lights, cargo). Precautions should be taken to eliminate the potential for damage caused by flying debris.

#### **B12-2.8 Run-Up Pad Markings.**

Proper marking of engine run-up pads is critical to ensure aircraft positioning complies with required standoff distances. All markings should comply with service-specific instructions and UFC 3-260-04, *Airfield Pavement Marking*. The following guidance shall be followed on current and future run-up pad locations:

- Provide a centerline marking that runs parallel to the prevailing wind direction specific to the run-up pad.
- Provide a nose wheel stop-block marking for the primary assigned aircraft that will be using the run-up pad. If several different aircraft are assigned to the installation, provide a nose wheel stop-block marking for the most demanding aircraft. Aircraft may be parked on nose wheel stop-block markings that provide more standoff distance than required. However, aircraft must not be parked on nose wheel stop-block markings that provide less standoff distance.
- Label each nose wheel stop-block marking for the aircraft that are intended to use it. Only mark blocks for primary assigned aircraft. Transient aircraft requiring use of the run-up pad should be evaluated on a case-by-case basis.

**APPENDIX B  
SECTION 13  
DEVIATIONS FROM CRITERIA FOR AIR FORCE AND ARMY AIRFIELD SUPPORT  
FACILITIES**

**B13-1 WAIVERABLE AIRFIELD SUPPORT FACILITIES**

**B13-1.1 Contents.**

This section provides information for selected airfield support systems and facilities that are authorized to deviate from criteria presented in this UFC with a specific waiver from the IMSC Detachment or USAASA (USA) as applicable. See Appendix B, Section 1 for waiver processing procedures. The standard designs for these facilities and systems are not considered frangible and therefore must not be sited within the frangibility zones described within paragraph B13-2.2 and Chapter 3. See Air Force Technical Order (T.O.) 31Z3-822-2. When airfield NAVAIDs, support equipment, or weather systems are decommissioned, become obsolete, or are deactivated for other reasons, the systems and all related equipment, structures, and foundations must also be removed from the airfield environment and the grades restored to comply with criteria provided in this UFC. Unless otherwise specified, the criteria (distances) referenced in the paragraphs below are applicable to Class A and B fixed-wing runways.

**B13-1.2 Navy and Marine Corps Requirements.**

This section does not apply to the Navy, and Marine Corps.

**B13-1.3 Fixed Base Airport Surveillance Radar (ASR) or Fixed Base Digital Airport Surveillance Radar (DASR).**

Radar that displays range and azimuth typically is used in a terminal area as an aid to approach and departure control. Normally, ASR and DASR are used to identify and control air traffic within 60 nautical miles of the airfield. The antenna scans through 360 degrees to give the air traffic controller information on the location of all aircraft within line-of-sight range. The antenna, located adjacent to the transmitter or receiver shelter, is elevated to obtain the required line-of-sight distance. Fixed radar siting in the continental United States (CONUS) will be accomplished in accordance with FAA Order 6310.6.

**B13-1.4 Airport Rotating Beacon.**

Airport rotating beacons are devices that project beams of light, indicating the location of an air base/airfield/heliport/helipad. Detailed siting guidance is found in UFC 3-535-01.

**B13-1.5 Nondirectional Radio Beacon Facilities.**

Radio beacon facilities are nondirectional aids used to provide homing, fixing, and air navigation assistance to aircraft with suitable automated direction-finding equipment. They consist of two categories: a medium-power, low-frequency beacon and a medium-power, ultrahigh-frequency beacon.

### **B13-1.6 Air Traffic Control Tower (ATCT).**

The ATCT Control Cab must be correctly oriented so that the area to be controlled is visible from the cab. Air traffic controllers must have proper depth perception of the area under surveillance and there can be no electronic interference with equipment in the cab or with navigational equipment on the ground. A site survey must be conducted to determine the best siting. For these and other operational and technical aspects and considerations for selecting a site, consult Service-specific requirements in the early stages of planning. For Air Force installations, contact Air Force Flight Standards Agency (AFFSA), Requirements and Sustainment Directorate, HQ AFFSA/XR; or for Army installations, contact the United States Army Air Traffic Services Command (ATSCOM), Fixed Base Systems Division (AFAT-ATS-CB), Building 50301 Nevin Street, Cairns Army Airfield, Ft. Rucker, AL 36362-5265. Specific architectural, structural, mechanical, and electrical systems design requirements may be found in UFC 4-133-01, *Air Traffic Control and Air Operations Facilities*. Also, see paragraph B13-2.21.3.6 and Appendix B, Section 16, paragraph B16-4.3.

## **B13-2 PERMISSIBLE DEVIATIONS FROM DESIGN CRITERIA.**

### **B13-2.1 Contents.**

This section furnishes siting information for airfield support facilities that may not conform to the airfield clearance and airspace surface criteria elsewhere in this UFC. This list is not all-inclusive. Siting and design for airfield facilities and equipment must conform to these design and siting criteria, and must be necessary for support of assigned mission aircraft, or a waiver from the MAJCOM or USAASA is required. If the equipment renders satisfactory service at locations not requiring a clearance deviation, such locations should be selected to enhance the overall efficiency and safety of airfield operations. When airfield NAVAIDs, support equipment, or weather systems are decommissioned, become obsolete, or are deactivated for other reasons, the systems and all related equipment, structures, and foundations must also be removed from the airfield environment and the grades restored to comply with criteria provided in this UFC.

- a. Any facilities in this chapter installed on rotary-wing runways (IFR/VFR) cannot violate the lateral clearance criteria, but is permissible within the transitional surface.
- b. Clear zones are comprised of two separate areas that are treated differently. This is because initially the area known as the clear zone was defined as "the areas immediately adjacent to the ends of a runway, which have been cleared of all above ground obstructions and graded to

minimize damage to aircraft that undershoot or overrun the runway." In 1974, DoD implemented a requirement for the Services to control development near military airfields to protect the safety, health and welfare of personnel on base and in the surrounding communities. This action was also intended to preserve maximum mission flexibility. To accommodate these needs, the clear zone size was expanded and the allowable uses were published within the Air Installation Compatible Use Zone (AICUZ) Program guidance, DoDI 4165.57. It is important to understand that all objects located within the expanded area of clear zones are not necessarily obstructions and there are no specific grading requirements for this area. Review current AICUZ criteria for land uses in this area before initiating development.

**NOTE:** For Air Force operated airfields (including those at Joint Bases): AFI 32-7063, Air Installations Compatible Use Zones (AICUZ) Program, directs that Air Force facility sitings, construction and land use must be consistent with the land use recommendations in the AFI and provides specific guidance on what is and is not allowed in the Clear Zone. Essential navigation aids and operational facilities can be located in the clear zone if there are no feasible alternatives. Due to the high potential for accidents in the CZ, facilities/equip listed in this section that are not required to be located in this area, especially those with personnel/people (i.e. facilities with classrooms or offices) should be considered for locations outside the clear zone. If they must be located within the clear zone to support the safe operation of the airfield, documents supporting the need to locate these facilities/equipment within the clear zone should be kept on file (including other locations evaluated and found unsuitable in order to communicate the decision to locate these objects within Air Force controlled areas of the Clear Zone. Any other uses within the clear zone will require a clear zone variance be completed (see AFI 32-7063).

### **B13-2.2 Frangibility Requirements.**

All structures placed or constructed within the airfield environment must be made frangible (to the maximum extent practicable) or placed below grade unless otherwise noted in the definitions that follow or unless specifically described as exempt from frangibility requirements using the siting criteria in this UFC. This applies for any above ground construction within 76 meters (250 feet) of a fixed wing runway centerline and an extension of that dimension for 914 meters (3,000 feet) beyond the ends of the runway thresholds and within the taxiway clearance line (see Table 5-1, Item 10), but is limited to structures owned or controlled by DoD. For VFR helicopter runways/helipads (except limited use facilities) frangibility requirements apply within 30 meters (100 feet) of centerline/center of helipad and an extension of that dimension beyond the ends of the runway threshold/ approach/departure surface for 120 meters (400 feet) and within the rotary-wing taxiway clearance line (see Table 5-2, Item 5). For IFR helicopter runways/helipads (except limited use facilities) frangibility requirements apply within 53

meters (175 feet) of centerline/center of helipad. Frangibility implies that an object will collapse or fall over after being struck by a moving aircraft with minimal damage to the aircraft to the maximum extent practicable. The constructed object must not impede the motion or radically alter the path of the aircraft. Foundations for frangible structures shall be constructed flush with finished grade and the surrounding soil shall be compacted. Corrective action is required if more than 76 millimeters (3 inches) of the vertical surface of any foundation is exposed above finish grade. All structures shall be designed to allow performance of the structure to withstand wind loads less than 112 kilometers per hour (70 miles per hour). At wind speeds and icing conditions above permissible airfield operations conditions, deflections shall remain within the elastic performance of the structure. This concept does not include structures intended to house people. Integral fuel tanks should be used for necessary emergency power generator sets. If auxiliary fuel tanks are required for emergency generators, or integral fuel tanks are not available, place the fuel supply system below grade with other supporting utilities.

### **B13-2.2.1 Types of Frangible Devices and Structures.**

Essentially, there are three types of frangible devices and structures. These are normally related to the height of the structure. They are described below.

#### **B13-2.2.1.1 Frangible Support.**

A support for elevated fixtures or other devices composed of a supporting element with a fracture mechanism at its base. It is designed to present a minimum of mass and to break at the base when impacted. It is typically used when the mounting height is 2 meters (6 feet) or less above the mounting surface.

#### **B13-2.2.1.2 Low-Impact Resistant Support.**

A support for elevated fixtures or other devices designed to present a minimum mass and to break with a minimum resistance when impacted. Normally used for supporting lights or other devices between 2 meters and 12 meters (6 feet and 40 feet) above the mounting surface.

#### **B13-2.2.1.3 Semi-Frangible Support.**

A two-element support for light fixtures or other devices designed for use in applications where the mounting height is over 12 meters (40 feet) above the ground or the facility, or the device is constructed over a body of water. These type supports are comprised of a rigid base or foundation with a frangible or low-impact-resistant support used for the upper portion of the structure. The rigid portion of the structure must be no higher than required to allow performance and maintenance of the apparatus and the frangible or low-impact-resistant support.

### **B13-2.2.2 Frangibility Requirements.**

New designs for airfield equipment, systems, and other facilities must meet the design and testing criteria given in ICAO Document 9157, *Aerodrome Design Manual*, Part 6, "Frangibility," First Edition, 2006, as well as the following guidelines for acceptance as a permissible deviation. Siting criteria provided within this UFC shall be used in lieu of the siting standards provided within Part 6 of the *Aerodrome Design Manual*. These requirements do not apply to facilities that house people.

**B13-2.2.2.1 Frangible Structures.**

Construction above the ground surface that will collapse or shatter upon impact. The structure must be designed using materials of minimum mass that will either break into segments or shatter without impaling the aircraft skin or becoming an obstacle to the continued movement of the aircraft.

**B13-2.2.2.2 Frangible Support.**

Used for mounting fixtures or equipment items less than 2 meters (6 feet) in height. The structure will be of minimum mass and will separate at the base connection when struck by a moving aircraft. Upon separation of the base connection, the support must not alter the path or impede flight of the aircraft if a segment of the structure wraps around the aircraft. The structure also must not impale the aircraft.

**B13-2.2.2.3 Low-Impact-Resistant Support.**

Used for supporting elevated fixtures or equipment items more than 2 meters but less than 12 meters (6 to 40 feet) above the ground surface, typically towers or poles. Upon impact by aircraft, the structure will be designed to break away at or below the impact location and collapse without wrapping around the aircraft, impaling the aircraft, or causing significant structural damage to the aircraft. If the design is such that potential exists for a portion of the structure to wrap around the aircraft, it shall not significantly alter the path or flight trajectory, nor prevent the aircraft from completing a successful takeoff or landing. Collapse of the structure may occur at a single point of failure or may be a segmented collapse. The structure shall be designed such that service of the equipment must be accomplished by lowering the equipment. The design shall not include elements that permit climbing by means of a built-in ladder or other scaling devices.

**B13-2.2.2.4 Semi-Frangible Support.**

Semi-frangible supports are used for those elevated fixtures or equipment items that must be higher than 12 meters (40 feet) or constructed over a body of water. The foundation shall be no higher above grade or the surface of the water than necessary to allow performance and maintenance of the apparatus and the frangible or low-impact-resistant support. The upper portion of the structure will be constructed of multiple elements of low-impact-resistant supports. The supports may be in pairs that provide directional stability or groups that provide stability to the grouping as an element. Upon impact by aircraft, each of the supporting elements will be designed to collapse as a unit

or in segments independent of the grouping. The elements of the supporting structure will not impale the aircraft, wrap around the aircraft, or significantly change aircraft direction of travel upon impact. If the design is such that potential exists for a portion of the structure to wrap around the aircraft, it shall not significantly alter the path or flight trajectory, nor prevent the aircraft from completing a successful takeoff or landing. The group of elements may incorporate climb-to-service devices such as ladders, provided they comply with applicable safety criteria.

### **B13-2.3 Visual Air Navigational Facilities.**

This term identifies, as a type of facility, all lights, signs and other devices located on, and in the vicinity of, an airfield that provide a visual reference to pilots for guidance when operating aircraft in the air and on the ground. These facilities supplement guidance provided by electronic aids, such as tactical air navigation (TACAN) and precision approach radar (PAR). When constructed and sited in accordance with Air Force/Army standards, these components and systems are frangible. Systems and components not designed and constructed in accordance with Air Force/Army standards must be programmed for replacement. For detailed construction and siting criteria, see AFI 32-1044 and UFC 3-535-01.

### **B13-2.4 Radar Facilities.**

Services use various fixed-base radar facilities, such as Ground Control Approach (GCA), Radar Approach Control (RAPCON) (USAF), Army Radar Approach Control (ARAC) (Army) to support local radar air traffic control operations. The radar sets are situated for the best possible coverage of air traffic operations. The radar data may be relayed many miles between the radar set and the radar facility, so the site is very often separated from the operations facility. These facilities provide air traffic controllers information on aircraft alignment, rate of descent, and relative position in the approach. See paragraph B13-1.3 for fixed airport surveillance radar (ASR) and digital airport surveillance radar (DASR) siting guidance.

#### **B13-2.4.1 Permanent GCA/RAPCON/ARAC Facilities.**

Permanent GCA/RAPCON/ARAC facilities house the radar operations center, radar equipment room, training facilities, office spaces, emergency and standby power services, and telecommunications service connections. The fixed GCA/RAPCON/ARAC facilities are sited outside the airspace boundaries required for safe air traffic control operations.

#### **B13-2.4.2 Mobile GCA and Mobile RAPCON Systems.**

Mobile GCA and mobile RAPCON systems are designed to set up at remote deployed locations or stateside in garrison or at temporary training locations.

##### **B13-2.4.2.1 Mobile GCA.**



The GCA usually consists of two equipment shelters, one containing the precision approach and ASR and the other shelter containing the air traffic control operations center. Both shelters come with support generators, environmental control units, and remote communications equipment. The radar and operations shelters may be separated by up to 30 meters (100 feet). These units are non-frangible.

#### **B13-2.4.2.2 Mobile RAPCON.**

The mobile RAPCON usually consists of mobile ASR, mobile PAR, and one or two mobile operations shelters. The mobile ASR and the mobile PAR may be remotely located from the operations center by several miles via fiber optic cable. The siting of the mobile RAPCON system is dependent upon several factors and is determined before deployment by a survey team from the deploying unit. Each of the mobile RAPCON shelters comes with support generators, environmental control units, and communications remoting equipment. The footprint of the deployed systems is determined during pre-survey coordination meetings between the deploying unit and local airfield manager. These units are non-frangible.

#### **B13-2.4.3 GPM-22 PAR Units.**

PAR systems (AN/GPN-22) must be sited not less than 156 meters (512 feet) from the centerline of a runway to the near edge of the equipment. The reference reflector must be positioned so that the reflector and the radar antenna are parallel with runway centerline ( $\pm 0.005^\circ$ ), be in clear and unobstructed view of the radar antenna, and be located in an area where there are no large reflecting objects. Specific siting criteria for this system is provided in Air Force T.O. 31P5-2GPN22-12. When it is necessary to place units between parallel runways with insufficient distance to allow a 156-meter (512-foot) clearance to each runway centerline, the system shall be sited to provide the minimum distance to the centerline of the primary instrument runway and the lesser clearance to the centerline of the other runway. While it is desirable, from a safety standpoint, to keep these units as low as possible, the final elevation for the units will be determined by AFFSA ATCALs. The elevation is dependent on the necessary lines of sight between the unit and calibration reflectors and the touchdown areas of the runways. If it is necessary to change the existing ground elevation to provide a proper height for these units, follow grading requirements discussed in Chapter 3. These systems are non-frangible.

#### **B13-2.4.4 AN/TPN-31 or ATNAVICS (Air Traffic Navigation, Integration, and Coordination System).**

ATNAVICS is a highly mobile ground-controlled approach system that provides air traffic services where no operational airport control and landing system exists. It consists of an Airport Surveillance Radar (ASR), Precision Approach Radar (PAR), and Secondary Surveillance Radar (SSR).

The ATNAVICS system includes a sensor vehicle, sensor trailer with mounted generator, operations shelter, and an operations trailer with mounted generator. The

near edge of the sensor vehicle and sensor trailer with mounted generator will be sited no less than 300 feet from the runway centerline. The operations shelter and operations trailer with mounted generator will be sited no less than 500 feet from the runway centerline. See B13-2.7.2 for siting of reflectors.

**B13-2.4.5 AN/FPN-67 or FBPAR (Fixed Base Precision Approach Radar).**

The AN/FPN-67 is a modern, solid-state, reliable, ground-based, precision approach radar in a fixed-shelter (or integrated with the ATNAVICS system). AN/FPN-67 systems must be sited not less than 156 meters (512 feet) from the centerline of a runway to the near edge of the equipment. See B13-2.7.2 for siting of reflectors.

**B13-2.5 Emergency Generators, Maintenance and Personnel Facilities (Non-Frangible).**

These facilities may be collocated with GCA facilities and mobile RAPCON vans as follows:

- a. Trailers of standard mobile home construction or pre-engineered construction may be used for maintenance and personnel facilities. (Non-frangible)
- b. The entire GCA or RAPCON complex consisting of radar vans, emergency generators, maintenance and personnel trailers must be confined to a site not to exceed 45.7 meters long by 30.5 meters wide (150 feet by 100 feet), with the long side perpendicular to the main runway. The elevation of antennas and other projections will be held to the minimum essential for proper operation. Make every effort to keep the site as small as possible and to maintain the greatest possible distance from the runway. The perimeter of the site must be clearly marked and all future requirements contained within the area. Integral fuel tanks should be used for necessary mobile emergency power generator sets. If additional tanks are required or integral fuel tanks are not available, place the fuel supply system below grade with other supporting utilities.

**B13-2.6 Remote Microwave Link (Non-Frangible).**

This equipment provides remote operation and control of PAR and GCA facilities and must be sited adjacent to them. In siting the antenna, make sure that the increase in size of the total complex does not exceed the specified size of the area previously given for the GCA facility and RAPCON facility.

**B13-2.7 PAR Reflectors (Frangible and Non-Frangible).**

**B13-2.7.1 Air Force.**

For the Air Force, moving target indicator (MTI) reflectors, or "target simulators," may not be sited less than 45.7 meters (150 feet) from the near edge of a runway nor less

than 38.1 meters (125 feet) from the near edge of a taxiway or apron boundary marking to the centerline of the equipment. For the Army, MTI reflectors may not be sited less than 76.2 meters (250 feet) from the near edge of a runway nor less than 38.1 meters (125 feet) from the near edge of a taxiway or apron boundary marking to the centerline of the equipment. The height of these reflectors must be held to a minimum consistent with the operational requirements of the system. MTI reflectors sited less than 152.4 meters (500 feet) from the centerline of any runway must be of frangible construction, using breakaway sections in reflector masts. Tracking reference reflectors must not be installed closer than 152.4 meters (500 feet) to the centerline of any runway, nor exceed 18.3 meters (60 feet) in height above the centerline elevation of the nearest runway at the intersection of the equipment centerline perpendicular with the runway centerline.

**B13-2.7.2 Army.**

For Army, at least one reflector must be located within the AN/FPN67/AN/TPN-31 PAR azimuth angle coverage area in order to provide a horizontal reference point. Reflectors may not be sited less than 45.7 meters (150 feet) from the near edge of a runway nor less than 38.1 meters (125 feet) from the near edge of a taxiway or apron boundary marking to the centerline of the equipment. Reflectors sited less than 76.2 meters (250 feet) from the runway centerline must be of frangible construction, using breakaway sections of reflector masts, nor exceed 3 meters (10 feet) in height above the centerline elevation of the nearest runway at the intersection of the equipment centerline perpendicular with the runway centerline.

**B13-2.8 Airborne Radar Approach Reflectors (Non-Frangible).**

Airborne radar approach reflectors may be placed not less than 99.1 meters (325 feet) from the runway edge and not less than 121.9 meters (400 feet) nor more than 228.6 meters (750 feet) from the runway centerline to the edge of the equipment in a pattern parallel to the runway.

**B13-2.8.1 Army.**

For Army, at least one reflector must be located within the AN/FPN67/AN/TPN-31 PAR azimuth angle coverage area in order to provide a horizontal reference point. It can be sited within 250 feet of the runway centerline with an approved waiver. Reflectors sited less than 76.2 meters (250 feet) from the runway centerline must be of frangible construction, using breakaway sections of reflector masts, nor exceed 3 meters (10 feet) in height above the centerline elevation of the nearest runway at the intersection of the equipment centerline perpendicular with the runway centerline.

**B13-2.9 Instrument Landing System (ILS).**

Reference FAA Order 6750.16 for siting criteria for the ILS.

**B13-2.9.1 ILS Localizer Antennas (Frangible).**

The localizer array should be located between 304.8 meters (1,000 feet) and 609.6 meters (2,000 feet) beyond the stop end of the runway. As a rule, siting must conform to approach-departure clearance surface criteria discussed in Chapters 3 and 4. Refer to FAA order 6750.16 if standard localizer antenna placement is not an option.

**B13-2.9.1.1 Far Field Monitor (FFM) (Frangible if Mounted on Low-Impact-Resistant Supports, Non-Frangible if Mounted on Utility Poles).**

The FFM is not required for CAT I ILS systems; however, it is required for CAT II and above systems. The FFM is considered part of the localizer system. However, it is sited at the opposite end of the runway from the localizer antenna array. Typical locations are 365.8 meters (1,200 feet) to 914.4 meters (3,000 feet) prior to the landing threshold. FFM antenna height is determined by line of sight to the localizer antenna array. The line of sight requirement can be relaxed if satisfactory localizer signal reception is proven with a portable ILS receiver at the proposed lower height of the FFM site. Just as with the localizer antenna array, the FFM antenna shall not penetrate the approach-departure clearance surface criteria discussed in Chapters 3 and 4. Army siting requirements are contained in FAA Order 6750.16.

**B13-2.9.1.2 ILS Localizer Transmitter (Non-Frangible).**

The ILS localizer transmitter is sited adjacent to the localizer antenna array. It must be located at least 76.2 meters (250 feet) from the extended runway centerline or a waiver is required. Emergency power generators must be as close to the facilities they support as practical.

**B13-2.9.2 ILS Glide Slope Antenna (Non-Frangible).**

The antenna mast or monitor should be located a minimum distance of 121.9 meters (400 feet) from the runway centerline to the centerline of the antenna, and should not exceed 16.7 meters (55 feet) in height above the nearest runway centerline elevation. A mast height of over 16.7 meters (55 feet) is permitted if the minimum distance from the runway centerline is increased by 3.1 meters (10 feet) for each 305 millimeters (1 foot) the mast exceeds 16.7 meters (55 feet). When the mast cannot, for technical or economic reasons, be located at a minimum distance of 121.9 meters (400 feet) from the runway centerline, the minimum distance may be reduced to not less than 76.2 meters (250 feet) from the centerline, provided the basic mast height of 16.7 meters (55 feet) is reduced 305 millimeters (1 foot) for each 1.5 meters (5 feet) it is moved toward the runway from the 121.9-meter (400-foot) point. Glide slope monitor units are considered part of the parent equipment. Emergency power generators must be as close to the facilities they support as practical, but no closer than the glideslope main facility.

**B13-2.9.2.1 ILS End Fire Glide Slope Antenna (Frangible).**

Site in accordance with FAA Order 6750.16. For the end-fire glide slope, the antenna array typically extends to 25 feet from the runway edge. This is allowed due to antenna fragility.

**B13-2.9.3 Marker Beacons (Non-Fragible).**

Marker beacons support instrument approach procedures. They are located on the runway centerline extended as noted.

**B13-2.9.3.1 Outer Marker (OM) Beacon.**

The OM beacon marks the point where the aircraft should intercept the glide slope. When the OM beacon cannot be located at this point, it is located between this point and the landing threshold, as close to this point as possible.

**B13-2.9.3.2 Middle Marker (MM) Beacon.**

**B13-2.9.3.3 The MM beacon is located from 609.6 meters to 1,828.8 meters (2,000 to 6,000 feet) from the instrument runway threshold. Inner Marker (IM) Beacon.**

The IM beacon is located to mark the point where the glide slope angle intersects the DH point of a CAT II ILS. An inner marker beacon is not used on a CAT I ILS. Marker beacons must not penetrate airspace clearance surfaces defined in this UFC.

**B13-2.10 Microwave Landing System (MLS) and Mobile Microwave Landing System (MMLS) (Non-Fragible).**

Use FAA Order 6830.5 for selecting MLS sites. Criteria for siting MMLS are provided within AFI 11-230. All installations should be sited the maximum distance from the runway centerline allowed by operational requirements but not less than 60.96 meters (200 feet). MMLS may be required to be sited as near as 45.72 meters (150 feet). Additionally, if the MMLS will be required to remain in service for more than 30 days, the antenna and associated operational equipment should be removed from the trailer and installed on a small foundation that is placed so that the surface is no higher than 76 millimeters (3 inches) above grade. The anchors used to secure the equipment should be the minimum size required to meet local requirements.

**B13-2.11 Mobile Navigational Aids and Communication Facilities (Non-Fragible).**

These units (including UAS TALS) follow the same general siting criteria as their fixed facility counterpart and the same deviations from standard clearance criteria are permissible. Power generators for these facilities will be located as close to the equipment and in as small a site configuration as possible.

**B13-2.12 Mobile Air Traffic Control Towers (MATCT)/Mobile Tower System (MOTS) (Non-Fragible).**

At least a 152.4-meter (500-foot) distance must be maintained between the centerline of any runway and the near edge of the tower. Power generators may be located in positions adjacent to the MATCT/MOTS. Communication antennas to be used with these towers, which are not mounted on the facility, require the same separation from the runway centerline as the parent equipment, fixed or mobile.

**B13-2.13 Terminal Very High Frequency Omnidirectional Facility and Very High Frequency Omnidirectional Facility (Non-Frangible).**

TVOR and VOR facilities may be located not less than 152.4 meters (500 feet) for Air Force (76.2 m or 250 ft for Army) from the centerline of any runway to the edge of the facility, nor less than 61 meters (200 feet) for Air Force (45.72 m or 150 ft for Army) from the centerline of a taxiway.

**B13-2.14 Tactical Air Navigation (TACAN) Facility and Very High Frequency Omnidirectional Radio Range (VORTAC) Facility (Non-Frangible).**

When used as terminal navigational aids, the TACAN, VOR, and VORTAC facilities may be sited not less than 152.4 meters (500 feet) from the centerline of any runway to the edge of the facilities, provided the elevation of the antenna does not exceed 15.2 meters (50 feet) above the highest point of the adjacent runway centerline. For an on-base installation, the maximum angle of convergence between the final approach course and the runway centerline is 30 degrees (30°). The final approach course should be aligned to intersect the extended runway centerline 3,000 feet (914.4 meters) outward from the runway threshold. When an operational advantage can be achieved, this point of intersect may be established at any point between the threshold and a point 5,200 feet (1,584.96 meters) outward from the runway threshold. Also, where an operational advantage can be achieved, a final approach course which does not intersect the runway centerline or intersects at a point greater than 5,200 feet (1,584.96 meters) outward from the runway threshold may be established, provided that such a course lies within 500 feet (152.4 meters) laterally of the extended runway centerline at a point 3,000 feet (914.4 meters) outward from the runway threshold.

**B13-2.15 Non-Directional Beacon (NDB) (Non-Frangible).**

When used as terminal navigational aid for the Army, the facility may be sited not less than 76.2 meters (250 feet) from the centerline of any runway to the edge of the facilities, provided the elevation of the antenna does not exceed 7.62 meters (25 feet) above the highest point of the adjacent runway centerline.

**B13-2.16 Tactical Automated Landing System (TALS) (Non-Frangible).**

This paragraph provides siting information for UAS support facilities that do not conform to the airfield clearance and airspace surface criteria elsewhere in this document. The MQ-1C Tactical Automated Landing System (TALS) and supporting equipment shall be sited at a maximum distance from the runway centerline allowed by operational requirements but not less than 250 feet. When the TALS is required to be sited within

250 feet it must meet frangibility requirements and have an approved waiver IAW Appendix B, Section 1. All other supporting equipment shall be sited not less than 250 feet from the runway centerline. Under no conditions will the TALS be sited closer than 150 feet from the runway centerline. If line-of-sight is the basis of the waiver request then the waiver request will have a line-of-sight analysis justifying the operational distance from the runway centerline. Additionally, if the Tactical Automated Landing System-Tracking System (TALS-TS) will be required to remain in service for more than 30 days, the equipment should be installed on a small concrete foundation. No part of the TALS-TS foundation and any remaining structure attached to it will extend three inches or more above grade after the frangible connections fail.

**B13-2.17 Runway Supervisory Unit (RSU) (Non-Frangible) (USAF Only).**

An RSU is a transportable or permanent all-weather, control tower type facility used to control or monitor aircraft movement. The RSU complex, consisting of the facility and all support equipment, must be confined to a site not to exceed 15.2 meters (50 feet) long by 15.2 meters (50 feet) wide. A minimum distance of 76.2 meters (250 feet) must be maintained between the runway centerline and the RSU facility and support equipment. Integral fuel tanks should be used for necessary mobile emergency power generator sets. If additional tanks are required or integral fuel tanks are not available, place the fuel supply system below grade with other supporting utilities.

**B13-2.18 Fixed Base Weather Observing Systems (Non-Frangible).**

A permanently installed automated FBWOS (e.g., AN/FMQ-19, AN/FMQ-22, AN/FMQ-23, or ASOS) consists of a suite of weather sensors and processors capable of collecting, measuring or calculating and reporting a myriad of weather elements. These elements include, but are not limited to, wind direction and speed, prevailing visibility, present weather and visibility obstructions, cloud coverage and cloud base height, temperature, dew point, atmospheric pressure, lightning, and precipitation amounts. The observing system's primary sensor suite contains the majority of the sensors. Many locations also have additional discontinuity sensor suites. The discontinuity suite contains fewer sensors than the primary suite and is sited at the runway's roll out, midfield, or in the case of a multi-runway configuration, at an adjacent site along a parallel or intersecting runway in order to provide critical weather element readings that are representative of the respective location. Selecting appropriate locations to install sensor groups is a critical consideration for flight operations safety as well as to ensure the weather elements collected are representative of the meteorological conditions affecting flight operations. The primary and discontinuity sensor groups will be aligned parallel to the runway and must be not less than 300 feet (Class A/Rotary-Wing Runways) or 400 feet (Class B) from centerline of the runway as close as possible to the touchdown point (between 1000 and 3000 feet down from the runway threshold). Fixed base weather systems are mounted on concrete footings or foundations and may vary in dimension depending on type of system suite. The top surface of these concrete structures will be flush with the surrounding surface grade. For siting criteria of a FBWOS near taxiways and parking aprons on airfields and heliports, use Tables 5-1, 5-

2, and 6-1 in this manual. In cases where real-estate and/or terrain do not permit siting according to the UFC's direction, a waiver with supporting justification is required by Air Force IMSC Detachment or Garrison Commander at Army locations.

**B13-2.19 Wind Direction Indicators (Frangible and Non-Frangible).**

**B13-2.19.1 Wind Cones.**

See UFC 3-535-01 for appropriate siting.

**B13-2.19.2 Landing Direction Indicator (Landing "T" or Tetrahedron) (Non-Frangible).**

A landing "T" or tetrahedron must be located at least 83.82 meters (275 feet) from the edge of a runway to the centerline of the equipment.

**B13-2.20 UAS Support Equipment (Frangible and Non-Frangible).**

UAS support equipment is mobile and moved around the base to meet mission requirements. Equipment must be frangible whenever feasible. Acceptable runway centerline offset for support equipment is 250 ft. Acceptable taxiway centerline offset is 100 ft. Minimum 50 ft taxiway wingtip clearance is required for any non-local aircraft.

**B13-2.20.1 Ground Data Terminal (GDT).**

Line of Sight (LOS) Antenna that controls aircraft within LOS. The GDT must be elevated to avoid LOS signal interruption.

**B13-2.20.2 GDT Towers.**

Towers (mobile and fixed) that elevate the GDT above potential LOS interference.

**B13-2.20.3 Ground Control Station (GCS).**

Container/facility from where the Pilot and Sensor Operator control aircraft

**B13-2.20.4 Satellite Antenna (PPSL).**

Satellite antenna dish that controls aircraft beyond LOS.

**B13-2.20.5 HVAC.**

Equipment for cooling.

**B13-2.20.6 UHF/VHF Antennas.**

radio antenna to communicate with Tower and Crew Chiefs.

**B13-2.20.7 Concrete Pads.**



Concrete pads set in the turf or pavement for parking mobile equipment. Pads must be constructed flush with the surrounding grade.

**B13-2.21 General Information for Operational and Maintenance Support Facilities.**

Detailed siting information is furnished in this section, where appropriate.

**B13-2.21.1 Operational Facilities.**

**B13-2.21.1.1 Aircraft Arresting Systems and Barriers (Net Engaging Systems) (Non-Frangible).**

A series of components used to engage an aircraft and absorb the forward momentum of a routine or emergency landing (or aborted take-off). See AFI 32-1043 or NAVAIR 51-5-31 for detailed siting criteria and other information and requirements.

- a. Current aircraft arresting systems installed under previous criteria and standards may continue in service without waiver if they do not impair operational safety. The BCE's representative should identify such systems to flight safety and operations through the airfield manager, determine the proper risk mitigation, and program these systems for replacement. This should be done annually in conjunction with the annual waiver review. Such systems are: BAK-12 with two-roller deck sheave-type runway edge sheaves; BAK-12 systems with two-roller fairlead beam runway edge sheaves; on-grade BAK-12 systems installed before 1 July 1977 that are sited less than 76.2 meters (250 feet) from runway centerline (see grandfather allowance in AFI 32-1043); BAK-9 systems with two-roller deck-sheave runway edge sheaves; and BAK-13 systems; E-28 Arresting Gear Systems for Navy runways.
- b. BAK-12 energy absorbers installed on-grade may not be sited less than 83.82 meters (275 feet) from runway centerline. Slopes over tape tubes for all types of installations must comply with criteria for shoulder grading provided in Chapter 3. Fairlead and three-roller deck sheave foundations must be constructed in accordance with Air Force Typical Installation Drawings 67F2013A, applicable to three-roller fairlead beams (e.g., sloped 30H to 1V). Protective shelters constructed for on-grade installations must be constructed from lightweight framing materials and sheathing using connections that will allow the structure to break away and collapse if struck by an aircraft wing. The overall height of the structure must be kept to the absolute minimum to meet mission requirements. See Typical Installation Drawing 67F2013A for suggested sources. For structures that must be constructed to resist high wind or snow loads, consider internal bracing that can be quickly and easily installed when such weather events are forecast, rather than concrete masonry or heavy steel designs.

- c. BAK-15 barrier masts and hydraulic system components may be sited within 3 meters (10 feet) of the overrun edge. This is necessary to minimize the mast height needed to maintain the centerline height of the net. Foundations must be constructed flush with grade or grading surrounding the foundations shall be shaped to comply with the grading allowances provided for shoulders in Chapter 3, Table 3-4, Items 5 and 6.
- d. Textile brake aircraft arresting systems may be sited adjacent to the runway or overrun edges, whether in a paved or unpaved surface. Cable pretensioning devices should be sited as far from the overrun or runway edge as possible. All foundations shall be flush with grade except the leading edge of the module foundations which have a 76.2-millimeter (3-inch) or less vertical drop to provide jet blast protection for the modules. Unidirectional models of this system, such as the MB 60.9.9, are not sited between the thresholds.
- e. When aircraft arresting systems are decommissioned and removed from the airfield environment with no intent of replacement in the existing location, all related structures and foundations must be demolished and removed from the airfield. Grades in the area must be restored to comply with criteria provided in this UFC, as appropriate.

**B13-2.21.1.2 Warm-up or Holding Pad.**

The warm-up or holding pad is a paved area adjacent to the taxiway and the runway end. It provides a means of bypassing aircraft being held at the runway end for various reasons. For detailed design and siting criteria, see Chapter 6.

**B13-2.21.1.3 Arm/Disarm Pad.**

Arm/disarm pads are used for arming aircraft just before takeoff and for disarming weapons retained or not expended upon the aircraft's return. For detailed siting criteria and other information, see Chapter 6. When a personnel shelter is required, it is considered a part of the arm/disarm complex and must be sited to provide minimum wingtip/rotor clearance for the adjacent pavement type (taxiway or taxilane) and according to explosives quantity-distance criteria as discussed in Appendix B, Section 9 and AFMAN 91-201/DA PAM 385-64 for Air Force and Army respectively. Also see paragraph B13-2.21.2.8.

**B13-2.21.1.4 Helicopter Autorotation Lanes (Also Called "Slide Areas" or Skid Pads").**

Such lanes may be sited on or between active runways without a waiver. Ensure they are sited to prevent conflicts in operations (safety clearance zones must not overlap operational areas that will be used simultaneously).

**B13-2.21.1.5 Vehicle Control Signs and Traffic Lights (Frangible and**

**Non-Frangible).**

These signs and lights provide drivers with guidance on traffic routes, service yard areas, and similar places. They provide warning information at runway and taxiway crossings and other hazardous points. Vehicle control signs and traffic lights may be located on the airfield movement area (including apron) without a waiver to criteria. However, a traffic engineering study should be accomplished and coordinated with civil engineers, airfield management, and safety before traffic control devices are selected and installed. (Refer to Army Military Traffic Management Command [MTMC] Pamphlet 55-14 for information on obtaining assistance with traffic engineering studies.) In siting vehicle controls signs and traffic lights, make sure that they do not obstruct taxiing or towed aircraft. Incorporate frangibility into existing designs to the maximum extent practicable by saw-cutting wood posts on opposing sides to a depth of approximately one-third the cross-section of the post, or chain-drilling metal posts to provide an intended break point near the base. Modifications of this type must be made at a point no more than 76.2 millimeters (3 inches) above grade. Incorporate more precise frangible designs as these devices are replaced. See paragraph B13-2.2.2 for further guidance.

**B13-2.21.1.6 Runway Distance Remaining (RDR) Signs (Frangible).**

These signs are required for runways used by jet aircraft and are recommended for runways used by propeller-type aircraft. For detailed siting and design guidance, see AFI 32-1044 and UFC 3-535-01.

**B13-2.21.1.7 Aircraft Security System (Frangible and Non-Frangible).**

If a security system or fence is approved by the Air Force for airfield security, such as the microwave fence sensor or similar system as required by AFI 31-101, approval of the siting by the AFIMSC Detachment operation and safety offices will allow siting the system without waiver. No fence shall be allowed to penetrate the primary or approach-departure clearance surfaces without a waiver.

- a. Flightline security sensor supports originally developed for the tactical area security system (TAAS) were tested and qualified as acceptable frangible mounting supports for various types of security sensors. These supports may be used over the entire airfield if sited to comply with the following guidelines.
  - **Taxiways.** Conformance with criteria for taxiway signs must be met (distance and height).
  - **Aprons.** TAAS security sensor mounts will be allowed on aprons, provided minimum taxiway wingtip clearance (as described in Chapter 6 for peripheral, through, and interior taxiways) is maintained. There is no height restriction for supports up to 3 meters (10 feet) tall.

- **Runway/Overrun.** The closest distance from runway and paved overrun edge will be 30 meters (100 feet); closest distance to threshold (longitudinally) within the CZ will be 300 meters (1,000 feet). No penetrations of the approach-departure clearance surface will be allowed.

#### **B13-2.21.1.8 Defensive Fighting Positions (Non-Frangible).**

Although primarily used at deployed locations, base defense plans may require temporary defensive fighting positions (DFP) during base operational readiness exercises or increased force protection levels. DFPs are allowed to be sited within the primary surface and land use control area of the clear zone; however, they must not penetrate the approach-departure clearance surface or the runway/taxiway mandatory zone of frangibility. When temporary DFPs are not in use or are no longer required, they must be removed from the airfield and grades restored.

#### **B13-2.21.2 Maintenance Facilities.**

##### **B13-2.21.2.1 Jet Blast Deflectors (Non-Frangible).**

Jet blast deflectors are installed where continual jet engine run-up interferes with the parking or taxiing of aircraft, the movement of vehicles, the activities of maintenance personnel, or where it causes the erosion of pavement shoulders. To provide maximum efficiency, jet blast deflectors must be positioned at their optimum distance from the aircraft. They should be located to maintain nominal aircraft taxiing clearance distance as described in Table 6-1.

##### **B13-2.21.2.2 Floodlights (Non-Frangible).**

Floodlights illuminate aprons, alert stubs, specialized pads and other paved areas used for aircraft maintenance, loading/unloading, area security, and other reasons. Floodlights may be located on or near the apron, but must provide the minimum aircraft wingtip clearance in Table 6-1. They are not, however, exempt from the vertical restriction imposed by the transitional surface. Any deviation from this restriction must be waived, as discussed in Appendix B, Section 1.

##### **B13-2.21.2.3 Fire Hydrants (Non-Frangible).**

Fire hydrants may be installed within the apron clearance distances discussed in Chapter 6, provided the height is no more than 762 millimeters (30 inches) above the ground, and not more than 610 millimeters (24 inches) above the elevation of the adjacent load-bearing pavement. Hydrants must also be sited at least 25.6 meters (84 feet) from taxiway centerline. This is to provide the minimum clearance required by AFI 11-218 and is based on the geometry of a KC-135 aircraft positioned off taxiway centerline toward the hydrant, but with the outermost main gear still on the load-bearing pavement. Fire hydrants that violate the apron or taxiway lateral clearances will be completely painted with reflective paint or have a minimum 4" wide retro-reflective tape or paint surrounding stripe to ensure visibility during night operations. Normally bollards

are not required for hydrants located adjacent to aprons. Per UFC 3-600-01, they are required only for hydrants located near roads, streets, and parking lots. If unique circumstances dictate that bollards be installed to protect hydrants located adjacent to the apron, they must be sited at the minimum distance and maximum height provided above. For aprons not intended to support the KC-135, this distance must be computed for the most critical aircraft that will use the apron taxilane. In cases where hydrants were sited prior to the date of publication of this UFC and are found to be sited too close to the peripheral taxilane centerline, the painted taxilane centerline and apron boundary marking or the fire hydrant locations should be adjusted to provide a minimum of 3 meters (10 feet) from the hydrant or bollard to the nearest point on the most demanding aircraft that will use the apron, with the outermost main gear positioned at the edge of the load-bearing pavement. For additional siting criteria and other information on the location of fire hydrants, see UFC 3-600-01.

#### **B13-2.21.2.4 Explosives Safety Barricades (Non-Frangible).**

When barricades are an element in an aircraft alert complex, they may be located on or near the apron, but must be sited to provide minimum wingtip clearance distances in Table 6-1. For information on explosives safety standards, see AFMAN 91-201/DA PAM 385-64 for Air Force and Army respectively.

#### **B13-2.21.2.5 Ground Support Equipment (Mobile) (Non-Frangible).**

Mobile ground support equipment may be located on aprons, but must be positioned to provide minimum wingtip clearance distances prescribed in Table 6-1 for all aircraft other than those being serviced with the equipment. Examples of ground support equipment exempt under this category are: aerospace ground equipment; electrical carts; forklifts; tow bar trailers; fire extinguisher carts; material-handling equipment; flightline maintenance stands; stair trucks; and portable floodlights. Similar equipment may be included in this category. When such equipment is not in use, it must be removed from the aircraft parking area and stored in areas that do not violate aircraft clearance requirements for normal operating routes (marked taxilanes or taxiways) or other imaginary surfaces. For the purpose of this UFC, equipment in use is defined as support equipment in place not more than three hours before aircraft arrival or three hours after aircraft departure. Support equipment may remain on the ramp in an Ops Group approved location indefinitely. These locations should be marked on the pavement to ensure equipment is stored to meet aircraft wingtip clearance and any other operational criteria to provide for safe operations.

#### **B13-2.21.2.6 Flightline Vehicles (Non-Frangible).**

Motor vehicles are allowed, based on approved operational/mission requirements, to operate on or near the flight line, including runways, taxiways, aprons, and service roads, in accordance with the provisions of TC 21-305-20, Chapter 20, *Operation of Motor Vehicles on Flight Lines*, and applicable Service airfield/flightline driving regulations/guidelines. When not required, these vehicles are relocated away from the vicinity of the parked aircraft.

**B13-2.21.2.7 Ground Support Equipment (Stationary) (Non-Frangible).**

Stationary ground support equipment and the associated safety and security components are necessarily sited on and near aprons, but must be sited to provide the minimum wingtip clearance prescribed in Table 6-1, defined by the wingtip trace of the most demanding aircraft that will use the apron. This type of equipment should not be sited in a way that will require any part of the aircraft to overhang the equipment unless the components are located below grade and the access points meet applicable grading criteria and are designed to withstand wheel loads and jet blast as defined within Chapter 6 of this UFC and Appendix B, Section 7. Fuel safety shut-off switches may be sited in accordance with the siting criteria for fire hydrants or in accordance with siting criteria for airfield signs if they incorporate a frangible coupling at the base (see UFC 3-535-01). Examples of stationary ground support equipment are centralized aircraft support systems and pantograph refueling systems. This also includes markers for petroleum, oil, and lubricant (POL) supply lines, communications and utility lines, and property demarcation. Ensure proper lighting and fire safety features are included.

**B13-2.21.2.8 Crew Chief Shack (Non-Frangible).**

This facility, sometimes identified as an airfield maintenance unit, is a trailer or permanent prefabricated structure that may be located at the end of the runway, close to the arm/disarm pad or the apron edge. It may also be located on the apron, but must meet wingtip clearance requirements provided in Table 6-1. Although these shelters are allowed in the graded area of the clear zone, no shelter shall penetrate the approach-departure clearance surface, nor the runway or taxiway mandatory zone of frangibility. Explosive quantity distance criteria in AFMAN 91-201/DA PAM 385-64 applies to Air Force and Army respectively.

**B13-2.21.2.9 Service Roads.**

Service roads may be located on the perimeter of alert aprons, around specialized aircraft parking pads, or for access to NAVAIDs, aircraft arresting systems, weather sensors, and other similar areas on the airfield. Service roads are not permitted in the runway (graded) clear zones, unless access is controlled by air traffic control (Tower). In locating these roads, the wing overhang and appropriate safe clearance distance for the largest aircraft using the facility must be taken into account, and they must be marked or signed to identify VFR and instrument holding positions, to prevent encroachment into NAVAID critical areas or violation of the approach-departure clearance surface. The distance from the peripheral taxilane on an apron to the edge of the road is computed from the centerline of the aircraft's path, plus the minimum wingtip clearance given in Table 6-1, items 4, 5, and 6 (except at intersections with operational pavement). See UFC 3-260-04 for placement of runway holding positions and instrument landing system (ILS) or precision approach radar (PAR) critical areas. Ensure service roads are appropriately marked to control vehicular movement along and within the roadway. Markings shall be in accordance with AFI 32-1042 and the *Manual on Uniform Traffic Control Devices* (MUTCD), published by the Department of Transportation, Federal Highway Administration.

**B13-2.21.2.10 Fencing and Barricades (Jersey Barriers) (Frangible and Non-Frangible, respectively).**

Fencing and barricades are erected on airfields for a variety of purposes. They may be located on the perimeter of alert aprons, around specialized aircraft parking pads or NAVAIDs, and other similar areas on the airfield when necessary for security or force protection. When siting fences or barricades, the wing overhang and appropriate safe clearance distance for the largest aircraft using the facility must be taken into account. The distance from the nearest taxiway on an apron to the fence or barricade is computed from the centerline of the aircraft's path, plus the minimum wingtip clearance given in Table 6-1, items 4, 5, and 6. **Exception:** Barricades may not be located within the mandatory zone of frangibility for runways or taxiways without a waiver, and fences that must be constructed within these areas must meet wingtip clearance requirements and must be made frangible. No fence or barricade shall penetrate the primary or approach-departure clearance surfaces or the graded area of the clear zone. Installation perimeter fencing shall not be sited within the graded area of the clear zone (1,000 ft) but may be sited outside of it in the land-use area of the Clear Zone/Mandatory Zone of Frangibility to comply with required installation boundary security/force protection requirements. Fencing within the MFZ must be frangible or require a waiver. Penetrations to the 7:1 transitional surface are allowed without waiver for base boundary (property line) fences if they have no impact to existing or planned instrument procedures (TERPS). Barricades located on aprons within the primary surface must be marked and lighted as obstructions unless they are shielded by other obstructions that are marked and lighted, or are located on the outer periphery of the apron away from the runway, behind an aircraft parking area with an exempt status or approved waiver.

- a. **Snow Fencing.** This type of structure may be installed within the Runway Primary Surface or Transitional Surface(s) however it must be located outside of the Mandatory Frangibility Zone. Fencing will be of a sturdy yet non-permanent construction, of a height not exceed 6 feet tall and all fencing components will be removed during the season(s) when snow is not probable. Snow fencing location(s) will be selected in coordination with the installation Flight Safety and Airfield Management office concurrence. Snow fencing is not permitted in any location that will violate aircraft wingtip clearances criteria or that will interfere with NAVAIDs or METNAV devices

**B13-2.21.2.11 Wildlife Control Devices.**

Various devices such as propane cannons, sirens, and traps may require siting within the airfield environment for wildlife control. Ensure these devices are sited at least 30.5 meters (100 feet) from the near edge of runways and overruns. When sited along taxiways and aprons, ensure these devices do not pose a hazard to taxiing or towed aircraft and, as a minimum, conform to distance and height criteria for airfield signs (see UFC 3-535-01). For guidelines on wildlife control fences, see paragraph B13-2.21.2.10 above.

#### **B13-2.21.2.12 Bird Aircraft Strike Hazard (BASH) Radar Systems.**

Aircraft bird-strike avoidance radar systems should be sited off the airfield when possible. However, when no alternatives exist, these facilities are authorized as permissible deviations to airfield criteria, provided they are sited so they do not impact existing or planned instrument procedures (TERPS). They also must not be sited within 122 meters (400 feet) of runway centerline, the graded area of the clear zone, as a penetration to the approach-departure clearance surface, nor within any of the mandatory frangibility zones (see Tables 3-2 and 3-5). These areas include taxiway clearance distances and taxilane wingtip clearance distances (see Tables 5-1 and 6-1). Care must also be taken to ensure they are sited so they will not interfere with NAVAID critical areas or other airfield radar systems. Coordinate with the METNAV shop and communications to ensure these requirements are met.

#### **B13-2.21.2.13 Fuel Hydrants.**

Fuel hydrants may be installed within the apron clearance distances discussed in Chapter 6, provided the height is no more than 762 millimeters (30 inches) above the ground, and not more than 610 millimeters (24 inches) above the elevation of the adjacent load-bearing pavement. Fuel Hydrants must also be sited at least 25.6 meters (84 feet) from taxilane centerline. This is to provide the minimum clearance required by AFI 11-218 and is based on the geometry of a KC-135 aircraft positioned off taxilane centerline toward the hydrant, but with the outermost main gear still on the load-bearing pavement. Normally bollards are not required for hydrants located adjacent to aprons. If unique circumstances dictate that bollards be installed to protect hydrants located adjacent to the apron, they must be sited at the minimum distance and maximum height provided above. For aprons not intended to support the KC-135, this distance must be computed for the most critical aircraft that will use the apron taxilane. In cases where hydrants were sited prior to the date of publication of this UFC and are found to be sited too close to the peripheral taxilane centerline, the painted taxilane centerline and apron boundary marking or the fuel hydrant locations should be adjusted to provide a minimum of 3 meters (10 feet) from the hydrant or bollard to the nearest point on the most demanding aircraft that will use the apron, with the outermost main gear positioned at the edge of the load-bearing pavement.

#### **B13-2.21.3 Miscellaneous.**

##### **B13-2.21.3.1 Telephone and Fire Alarm Systems.**

Telephone and fire alarm system boxes may be located on or in the vicinity of aprons, provided the height of the structure does not constitute an obstruction to the most demanding aircraft that will use the apron.

##### **B13-2.21.3.2 Trash Collection Containers.**



Dumpsters and similar equipment may be located in the vicinity of an apron, provided appropriate wingtip clearance requirements given in Table 6-1, items 4, 5, and 6 are provided, and the location does not constitute a hazard to pedestrian or vehicular traffic from the debris.

**B13-2.21.3.3 Landscaping Around Flightline Facilities.**

Shrubs and other landscaping should conform to the height restriction discussed in paragraph B13-2.21.3.1 or must be located to provide the minimum wingtip clearances provided in Chapter 6.

**B13-2.21.3.4 Other Apron Facilities.**

Facilities other than those previously mentioned within this section may require siting near or on aprons due to their function and purpose. In these cases, ensure wingtip clearance shown in Table 6-1 is provided. Some examples of these type facilities are hangars, aircraft sunshades, wash racks, taxi-through alert shelters, air passenger terminals, movable passenger access platforms (jetways), base operations facilities, squadron operations facilities, airfield maintenance unit facilities, fire stations, fuel or groundwater recovery systems, material-handling equipment storage facilities, airfreight terminals, and weather shelters for sentries. Facilities must not penetrate imaginary surfaces without an approved waiver.

**B13-2.21.3.5 Utility Access Points.**

Utility handholes and manholes should be constructed flush with grade. These utility access points do not require a waiver if the drop-off at the edge of the top surface is 76 millimeters (3 inches) or less.

**B13-2.21.3.6 Air Traffic Control Towers.**

Air Traffic Control Towers may be considered permissible deviations to the transitional surface if it meets the siting criteria given in Appendix B, Section 16. For Army, Air Traffic Control Towers are not considered permissible deviations.

**B13-2.21.3.7 Runway Ice Detection System (RIDS).**

RIDS consists of four functional elements: in-pavement sensors; supporting power supply/signal processor units; terminal data processing units; and data display units/printers. The components sited within the airfield environment are authorized as a permissible deviation to airfield criteria provided in this UFC when sited as follows:

- a. The in-pavement sensors are installed in the runway pavement flush with and in the plane of the pavement surface. The head surface texture shall be similar to that of the surrounding pavement surface and approximate the flow and pooling characteristics of water on the surrounding pavement. The remote field units that provide power to the in-pavement sensor head, processes raw surface condition input data, collect air temperature and

related atmospheric data, and transmit the processed data to the terminal data processing unit are fixed by function and must be sited on the airfield.

- b. Where practical, these units should be collocated with other air navigational aids outside the mandatory frangibility zone (MFZ) so they do not conflict with other electronic and visual air navigational aids. If collocation is not possible, the units must be equipped with obstruction lights and shall be sited along the runway and taxiway, outside the MFZ but not within the last 304 meters (1,000 feet) of the runway. The height must be kept to the minimum practicable and the units must be equipped with a frangible coupling at the base. See FAA AC 150/5220-13 for more detailed information on these systems.

**B13-2.21.3.8 Utility Risers.**

Utility risers located near runways, taxiways and aprons supporting facilities listed as permissible deviations in this Section are authorized. Utility risers within the MFZ must be frangible. Utility riser must be lower than 4-ft tall. Utility riser shall have obstruction light installed when required per UFC 3-535-01.

CANCELLED

**APPENDIX B  
SECTION 14  
CONSTRUCTION PHASING PLAN AND OPERATIONAL SAFETY  
ON AIRFIELDS DURING CONSTRUCTION**

**B14-1 CONTENTS.**

A construction phasing plan must be included in the contract documents. The purpose of a phasing plan is to establish guidelines and constraints the contractor must follow during construction. It is recommended that the construction phasing plan be submitted for coordination and review at the concept and design stage. At minimum, the plan must be coordinated with airfield management, airfield operations, communications, ground and flight safety, environmental, security forces, contracting and logistics.

**B14-2 NAVY AND MARINE CORPS REQUIREMENTS.**

This section does not apply to the Navy and Marine Corps.

**B14-3 INFORMATION TO BE SHOWN ON THE CONSTRUCTION PHASING PLAN.**

The phasing plan will include, but is not necessarily limited to, the following:

**B14-3.1 Phasing.**

All construction activities will be separated into phases. The phasing plan will show or describe the sequence of construction activity for each phase. The phasing plan will be incorporated into the contractor's management plan and reflected in the progress schedule. The work area limits (to define required aircraft and worker safety and security clearances), barricades, maximum equipment height, and temporary fencing requirements will be clearly delineated for each phase. The work area limits will include identification of restricted areas requiring escorts and free zones with secure areas.

**B14-3.2 Aircraft Operational Areas.**

The phasing plan will identify active aircraft operational areas and closed pavement areas for each phase.

**B14-3.3 Additional Requirements.**

If required, the location of flagmen, security guards, and other personnel should be shown. These locations should be supplemented in the specifications.

**B14-3.4 Temporary Displaced Thresholds.**

Temporary displaced thresholds and temporary displaced threshold lighting requirements should be shown. These details will be presented in the drawings and supplemented in the specifications.

**B14-3.5 Access.**

Construction vehicle access roads, including access gates and haul routes, will be shown.

**B14-3.6 Temporary Marking and Lighting.**

Temporary pavement marking and lighting details will be presented on the phasing plan. Marking and lighting details are presented in UFC 3-260-04, UFC 3-535-01, and applicable FAA guidance.

**B14-3.7 Safety Requirements and Procedures.**

The construction phasing plan must include a section outlining safety requirements and procedures for activities on the airfield during the planned period of construction.

**B14-3.8 FOD Checkpoints.**

Location of foreign object debris (FOD) checkpoints, when required, should be included in the phasing plan.

**B14-4 OTHER ITEMS TO BE SHOWN IN THE CONTRACT DRAWINGS.**

The following items are not necessarily a part of the phasing plan, but will be included in the contract documents.

**B14-4.1 Storage.**

The contractor's equipment and material storage locations.

**B14-4.2 Parking.**

The contractor's personnel vehicle parking area and access routes to the work area.

**B14-4.3 Buildings.**

Location of the contractor's offices and plants.

**B14-4.4 Designated Waste and Disposal Areas.**

Off-site disposal should be included in the specifications.

**B14-5 MAXIMUM EQUIPMENT HEIGHT.**

The maximum height of construction equipment expected to be in use during construction must be included in the contract documents, the work order project requirements checklist, or other project guidance documents. This information must also be included on FAA Form 7460-1, *Notice of Proposed Construction or Alteration*. This

form must be submitted to the FAA 30 days before the start of construction if the maximum equipment height penetrates any of the surfaces described in FAR Part 77.

## **B14-6 OPERATIONAL SAFETY ON THE AIRFIELD DURING CONSTRUCTION.**

This section provides the minimum risk mitigation standards for Army and Air Force airfield construction projects and guidelines concerning operational safety on airfields during construction. This information is intended to assist civil engineers, airfield management, and safety personnel in maintenance of a safe operating environment. The principal guidelines provided here were taken from FAA AC 150/5370-2, latest version, but have been modified to better relate to Army and Air Force needs and terminology. Construction activity is defined as the presence and movement of personnel, equipment, and materials in any location that could infringe upon the movement of aircraft. Normal maintenance activities are exempt from these requirements. Some examples of exempt maintenance activities are grass cutting, minor pavement repairs, inspection, calibration, and repair of NAVAIDs and weather equipment, aircraft arresting systems maintenance, and snow removal operations.

### **B14-6.1 General Requirements.**

Construction activities on the airfield, in proximity to, or affecting aircraft operational areas or navigable airspace, must be coordinated with all airfield users before initiating such activities. In addition, basic responsibilities must be identified and assigned and procedures developed and disseminated to instruct construction personnel in airport procedures and for monitoring construction activities for conformance with safety requirements. These and other safety considerations must be addressed in the earliest stages of project formulation and incorporated in the contract specifications, the work order project requirements checklist, and/or other project guidance documents developed for in-house construction projects. Construction areas located within the aircraft movement area requiring special attention by the contractor or in-house construction activity must be clearly delineated on the project plans. The quality assurance personnel, airfield manager, and contract administrator should closely monitor construction activity throughout its duration to ensure continual compliance with safety requirements. At minimum, comply with the requirements in paragraphs B14-6.1.1 through B14-6.1.4. Otherwise, alternative safety mitigation plans must be developed and included in the construction waiver request for the installation commander's approval.

#### **B14-6.1.1 Runways.**

Activities within the graded areas of the clear zone will require threshold displacement sufficient to protect the approach-departure clearance surface, and adjustment to the departure runway end location to provide a minimum 305-meter (1,000-foot) safety area between the stop end of the runway and construction activities. Construction activities must not be conducted within a distance equal to the normal VFR holding position distance from the near edge of any active segment of a runway.

### **B14-6.1.2 Taxiways, Taxilanes and Aprons.**

Construction activity setback lines must be located at a distance to provide the minimum wingtip clearance required in Table 6-1, items 5 or 6, as appropriate, for the largest aircraft that will use the taxiway, taxilane or apron.

### **B14-6.1.3 Jet Blast.**

You must also consider jet blast effects on personnel, equipment, facilities, and other aircraft. Maintain a distance behind aircraft sufficient to dissipate jet blast to 56 kilometers per hour (35 miles per hour) and temperatures to a maximum of 38 degrees Celsius (100 degrees Fahrenheit), or ambient, whichever is more, or provide jet blast protection with a deflector.

### **B14-6.1.4 Marking and Lighting.**

Threshold displacements and runway end relocation must be marked and lighted in accordance with UFC 3-260-04, and UFC 3-535-01. Additionally, alternate temporary taxi routes on taxiways or aprons must be marked either with temporary paint markings or with frangible edge markers. They must also be lighted if they will be used during periods of darkness or during instrument flight rule operations. Closed taxiways or taxilanes on aprons must be marked or barricaded and normal lighting circuits disabled. Temporary obstructions, such as cranes, must be marked and lighted in accordance with FAA AC 70/7460-1. All hazardous areas (such as excavations or stockpiled materials) on the airfield must be delineated with lighted barricades on all exposed (visible or accessible) sides.

### **B14-6.2 Formal Notification of Construction Activities.**

Any entity, including the military, proposing any kind of construction or alteration of objects that may affect navigable airspace, including military airspace, as defined in FAR Part 77, is required to notify the FAA. FAA Form 7460-1 is used for this purpose.

### **B14-6.3 Safety Considerations.**

The following is a partial list of safety considerations which experience indicates will need attention during airport construction.

- a. Minimum disruption of standard operating procedures for aeronautical activity.
- b. Clear routes from firefighting and rescue stations to active airport operations areas.
- c. Chain of notification and authority to change safety-oriented aspects of the construction plan.
- d. Initiation, currency, and cancellation of Notice to Airmen (NOTAM).

- e. Suspension or restriction of aircraft activity on affected airport operations areas.
- f. Threshold displacement and appropriate temporary lighting and marking.
- g. Installation and maintenance of temporary lighting and marking for closed or diverted aircraft routes and disabling the normal lighting circuits for closed runways, taxiways, and taxilanes.
- h. Revised vehicular control procedures or additional equipment and manpower.
- i. Marking/lighting of construction equipment.
- j. Storage of construction equipment and materials when not in use.
- k. Designation of responsible representatives of all involved parties and their availability.
- l. Location of construction personnel parking and transportation to and from the work site.
- m. Marking/lighting of construction areas.
- n. Location of construction offices.
- o. Location of contractor's plants.
- p. Designation of waste areas and disposal.
- q. Debris cleanup responsibilities and schedule.
- r. Identification of construction personnel and equipment.
- s. Location of haul roads.
- t. Security control on temporary gates and relocated fencing.
- u. Noise pollution.
- v. Blasting regulation and control.
- w. Dust control.
- x. Location of utilities.
- y. Provision for temporary utilities and/or immediate repairs in the event of disruption.

- z. Location of power and control lines for electronic/visual navigational aids.
- aa. Additional security measures required if AFI 31-101 is impacted (relocation or reconstruction of fences or security sensors).
- bb. Marking and lighting of closed airfield pavement areas.
- cc. Coordination of winter construction activities with the snow removal plan.
- dd. Phasing of work.
- ee. Shutdown, relocation and/or protection of airport electronic and or visual navigational aids.
- ff. Smoke, steam, vapor, and extraneous light controls.
- gg. Notification to crash/fire/rescue and maintenance personnel when working on water lines.
- hh. Provide traffic directors/wing walkers, etc., as needed to assure clearance in construction areas.

**B14-6.4 Examples of Hazardous and Marginal Conditions.**

Analyses of past accidents and incidents identified many contributory hazards and conditions. A representative list follows:

- a. Excavation adjacent to runways, taxiways, and aprons.
- b. Mounds or stockpiles of earth, construction material, temporary structures, and other obstacles near airport operations areas and approach zones.
- c. Runway surfacing projects resulting in excessive lips greater than 25.4 millimeters (1 inch) for runways and 76.2 millimeters (3 inches) for edges between old and new surfaces at runway edges and ends.
- d. Heavy equipment, stationary or mobile, operating or idle near airport operations areas or in apron, taxiway, or runway clearance areas.
- e. Proximity of equipment or material which may degrade radiated signals or impair monitoring of navigational aids.
- f. Tall but relatively low-visibility units such as cranes, drills, and the like in critical areas such as aprons, taxiways, or runway clearance areas and approach zones.
- g. Improper or malfunctioning lights or unlighted airport hazards.



- h. Holes, obstacles, loose pavement, trash, and other debris on or near airport operations areas.
- i. Failure to maintain fencing during construction to deter human and animal intrusions into the airport operation areas.
- j. Open trenches alongside operational pavements.
- k. Improper marking or lighting of runways, taxiways, and displaced thresholds.
- l. Attractions for birds such as trash, grass seeding, or ponded water on or near the airfield.
- m. Inadequate or improper methods of marking temporarily closed airport operations areas, including improper and unsecured barricades.
- n. Obliterated markings on active operational areas.
- o. Encroachments to apron, taxiway, or runway clearance areas, improper ground vehicle operations, and unmarked or uncovered holes and trenches in the vicinity of aircraft operating surfaces are the three most recurring threats to safety during construction.

#### **B14-6.5 Vehicles on the Airfield.**

Vehicular activity on the airfield movement areas should be kept to a minimum. Where vehicular traffic on airfield operational areas cannot be avoided, it should be carefully controlled. A basic guiding principle is that the aircraft always has the right-of-way. Some aspects of vehicle control and identification are discussed below. It should be recognized, however, that every airfield presents different vehicle requirements and problems and therefore needs individualized solutions so vehicle traffic does not endanger aircraft operations. Personnel required to drive on the airfield must be knowledgeable of and comply with the procedures outlined in the installation airfield driving program.

##### **B14-6.5.1 Visibility.**

Vehicles which routinely operate on airport operations areas should be marked and/or flagged for high daytime visibility and, if appropriate, lighted for nighttime operations. Vehicles which are not marked and lighted may require an escort by one that is equipped with temporary marking and lighting devices. (See Air Force T.O. 36-1-191 and FAA AC 150/5210-5.)

##### **B14-6.5.2 Identification.**

It is usually desirable to be able to visually identify specific vehicles from a distance. It is recommended that radio-equipped vehicles which routinely operate on airfields be

permanently marked with identifying characters on the sides and roof. Vehicles needing intermittent identification could be marked with tape or magnetically attached markers. Such markers are commercially available. However, select markers that can perhaps be mounted inside the vehicle or tethered to the vehicle so they do not fall off during vehicle operation and present potential foreign object damage (FOD) to aircraft.

#### **B14-6.5.3 Noticeability.**

Construction vehicles and equipment should have automatic signaling devices to sound an alarm when moving in reverse.

#### **B14-6.5.4 Movement.**

The control of vehicular activity on airfield operations areas is of the highest importance. Airfield management is responsible for developing procedures and providing training regarding vehicle operations to ensure aircraft safety during construction. This requires coordination with airfield users and air traffic control. Consideration should be given to the use of two-way radio, signal lights, traffic signs, flagman, escorts, or other means suitable for the particular airfield. The selection of a frequency for two-way radio communications between construction contractor vehicles and the Air Traffic Control Tower (ATCT) must be coordinated with the ATC tower chief. At non-tower airfields, two-way radio control between contractor vehicles and fixed-base operators or other airport users should avoid frequencies used by aircraft. It should be remembered that even with the most sophisticated procedures and equipment, systematic training of vehicle operators is necessary to achieve safety. Special consideration should be given to training intermittent operators, such as construction workers, even if escort service is being provided.

#### **B14-6.6 Inspection.**

Frequent inspections should be made by the airfield manager, civil engineering contract inspectors, and other representatives during critical phases of the work to ensure the contractor is following the prescribed safety procedures and there is an effective litter control program.

#### **B14-6.7 Special Safety Requirements during Construction.**

Use the following guidelines to help develop a safety plan for airfield construction.

##### **B14-6.7.1 Runway Ends.**

Construction equipment will not penetrate the approach-departure clearance surface.

##### **B14-6.7.2 Runway Edges.**

Construction activities normally will not be permitted within 30 meters (100 feet) of the runway edge. However, construction may be permitted within 30 meters (100 feet) of

the runway edge on a case-by-case basis with a temporary waiver approved by the installation commander.

### **B14-6.7.3 Taxiways and Aprons.**

Normally, construction activity setback lines will be located at a distance to provide the minimum wingtip clearance required from Table 6-1, items 5 or 6, as appropriate, plus one-half the wingspan of the largest predominant aircraft that will use the taxi route from the centerline of the active taxiway or apron. However, construction activity may be permitted up to the taxiway and aprons in use, provided the activity is approved by the installation commander and NOTAMs are issued; marking and lighting provisions are implemented; and it is determined the height of equipment and materials is safely below any part of the aircraft using the airfield operations areas which might overhang those areas. Alternate taxi routes and procedures for wing-walkers should be included in the safety plan if adequate wingtip clearance cannot be provided.

### **B14-6.7.4 Excavation and Trenches.**

Excavations and open trenches may be permitted along runways up to 30 meters (100 feet) from the edge of an active runway, provided they are adequately signed, lighted and marked. In addition, excavation and open trenches may be permitted within 30 meters (100 feet) of the runway edge on a case-by-case basis; that is, cable trenches, pavement tie-ins, etc., with the approval of the installation commander. Along taxiways and aprons, excavation and open trenches may be permitted up to the edge of structural taxiway and apron pavements, provided the drop-off is adequately signed, lighted and marked.

### **B14-6.7.5 Stockpiled Materials.**

Extensive stockpiled materials should not be permitted within the construction activity areas defined in the preceding four paragraphs.

### **B14-6.7.6 Maximum Equipment Height.**

FAA Form 7460-1 shall be submitted when equipment is expected to penetrate any of the surfaces described in Appendix B, Section 5, FAR Part 77.9.

### **B14-6.7.7 Proximity of Construction Activity to Navigational Aids.**

Construction activity in the vicinity of navigational aids requires special considerations. The effect of the activity and its permissible distance and direction from the aid must be evaluated in each instance. A coordinated evaluation by the airfield manager, civil engineer, safety, and communications personnel is necessary. Particular attention needs to be given to stockpiling materials as well as to the movement and parking of equipment which may interfere with line-of-sight from the tower or interfere with electronic emissions.

### **B14-6.7.8 Proximity of Construction to Explosives QD Arc.**

Wing Explosive safety must obtain a waiver for any construction falling inside an explosives QD Arc.

#### **B14-6.8 Construction Vehicle Traffic.**

With respect to vehicular traffic, aircraft safety during construction is likely to be endangered by four principle causes: increased traffic volume; nonstandard traffic patterns; vehicles without radio communication and marking; and operators untrained in airfield procedures. Because each construction situation differs, airfield management must develop and coordinate a construction vehicle traffic plan with airfield users, air traffic control and the appropriate construction engineers and contractors. The plan, when signed by all participants, should become a part of the contract, the work order project requirements checklist, and/or other project guidance documents developed for in-house projects. Airfield management, quality assurance, and safety are responsible for coordinating and enforcing the plan.

#### **B14-6.9 Limitation on Construction.**

Open-flame welding or torch cutting operations are prohibited unless adequate fire and safety precautions are provided and have been approved by the fire chief. All vehicles are to be parked and serviced behind the construction restriction line and/or in an area designated by the contract, the work order project requirements checklist, and/or other project guidance documents developed for in-house projects. Open trenches, excavations, and stockpiled material at the construction site should be prominently marked with orange flags and lighted with flashing red or yellow light units during hours of restricted visibility and/or darkness. Under no circumstances are flare pots to be near aircraft operating areas. Stockpiled material should be constrained in a manner to prevent dislocation that may result from aircraft jet blast or wind. Material should not be stored near aircraft operating areas or movement areas.

#### **B14-6.10 Marking and Lighting Closed or Hazardous Areas on Airfields.**

To ensure adequate marking and lighting is provided for the duration of the project, the construction specifications, the work order project requirements checklist, and/or other project guidance documents must include a provision requiring the contractor or other construction activity to have a person on-call 24 hours a day for emergency maintenance of airport hazard lighting and barricades. See AFI 32-1042, UFC 3-260-04 and UFC 3-535-01 for marking and lighting requirements for closed pavement areas.

#### **B14-6.11 Temporary Runway Threshold Displacement.**

Identification of temporary runway threshold displacements must be provided as indicated in UFC 3-260-04, and UFC 3-535-01. The extent of the marking and lighting should be directly related to the duration of the displacement as well as the type and level of aircraft activity. Temporary visual aids must be placed to provide an unobstructed approach-departure clearance surface with a 3-meter (10-foot) buffer between the surface and the tallest equipment in the construction zone, and a 304.8-

meter (1,000-foot) -long overrun safety area beyond the departure end of the runway. Runway threshold displacements must be coordinated with the TERPS office as the displacement will require discontinuation of precision instrument procedures and may affect landing minima for non-precision procedures. Departure procedures will also have to be evaluated to determine the effects of the runway threshold displacements.

CANCELLED

THIS PAGE INTENTIONALLY BLANK

CANCELLED

**APPENDIX B  
SECTION 15  
ARMY AND AIR FORCE AIRCRAFT TRIM PAD AND THRUST ANCHOR FOR 267  
KILONEWTONS (60,000 POUNDS) AND 445 KILONEWTONS (100,000 POUNDS)  
THRUST**

**B15-1 PURPOSE.**

This Section presents design details for two aircraft trim pad anchoring systems designed to support working loads of 267 kN (60,000 lb) and 445 kN (100,000 lb) of thrust. This Section supersedes Air Force ETL 01-10, *Design and Construction of High-Capacity Trim Pad Anchoring Systems*.

**B15-2 BACKGROUND.**

A thrust anchor is constructed by embedding a steel anchor block trim pad into a large reinforced concrete block tie to the surrounding anchor concrete slab, and used to constrain fighter aircraft during power checks and routine engine maintenance procedures. Many existing aircraft anchor blocks were designed to withstand loads associated with F-4 operations and 267 kN (60,000 lb) thrust; however, the newer generation of fighter aircraft employs engines with much greater thrusts. At locations supporting those aircraft, the 445 kN (100,000 lb) anchor block must be used. At locations where only aircraft with lower thrust loads, smaller anchor blocks may be designed. **All anchors shall be clearly labeled with the design load rating.**

**B15-3 ANALYSIS AND VISUAL INSPECTIONS.**

Analyses of anchor block designs have concluded that the likely mode of failure will be rupture of the metal link; however, other modes could occur. Therefore, the critical areas for routine visual inspection should include the surface at the steel-concrete interfaces, the top of the weld between the curved bar and the web plate, and the weld on the metal link. Observable permanent deformation of the steel bar would indicate that appreciable plastic stains have occurred and that the strength of the anchor block system should be reviewed more carefully.

**B15-4 CONSTRUCTION.**

**B15-4.1 Materials and Manufacturing.**

The anchor steel shall be high-strength alloy with a yield strength of at least 689.5 MPa (100 kips per square inch). A high strength alloy must be used to keep the thickness of the bar to a diameter than can be bent 180-degrees at an inside radius of 101 mm (4 inches). Also, a thicker bar would make connection design more difficult.

**B15-4.2 Placement of Rebar.**

For the 445 kN (100,000 lb) anchor block, the rebar is designed so that pulling out the steel anchor would require pulling out the top layer of rebar. The top layer of rebar is set

over the 63-millimeter (2.5-inch) steel dowels that go through the web of the steel anchor. A minimum cover of 203 millimeters (8 inches) should be provided and checked before the concrete is poured.

**B15-4.3 Pouring and Finishing Concrete.**

Approximately 15,300 liters (20 yards) of concrete is needed for the 445 kN (100,000 lb) anchor block. Concrete must be placed evenly on both sides of the anchor so the anchor will not move while pouring. Minimum 34.4-megapascal (5000-psi) compressive strength concrete shall be used in anchor blocks.

CANCELLED



Figure B15-1. Example of 267 kN (60,000 LB) Square Aircraft Anchor Block and Cross Section

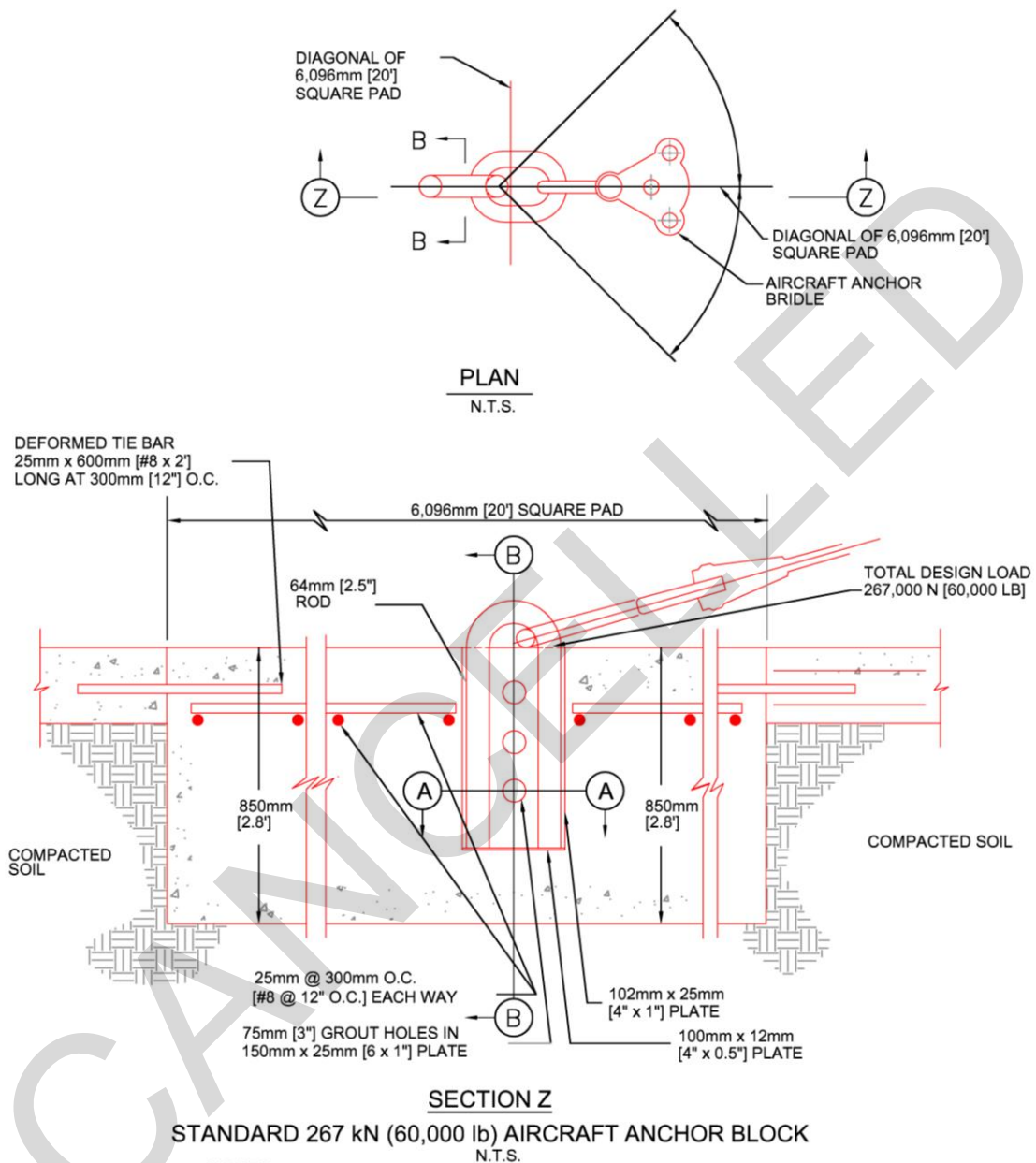

NOTES

1. THIS DESIGN IS FOR UP TO 267,000 N [60,000 LB] THRUST AND WILL ACCOMMODATE FIGHTER AIRCRAFT UP TO AND INCLUDING F-15E. THE DESIGNER MUST VERIFY STRUCTURAL DESIGN FOR THRUST OF DIFFERENT AIRCRAFT AND ENGINE TYPES.
2. DESIGN MAY BE SCALED DOWN TO MEET MISSION AIRCRAFT THRUST LOAD REQUIREMENTS. IF SCALED DOWN, THE ANCHOR MUST BE LABELED WITH THE MAXIMUM THRUST IT IS DESIGNED TO HOLD.
3. SEE FIGURE B15-2 FOR SECTION VIEW.

Figure B15-2. Example of 267 kN (60,000 lb) Square Anchor Block, Cross Section A-A and B-B

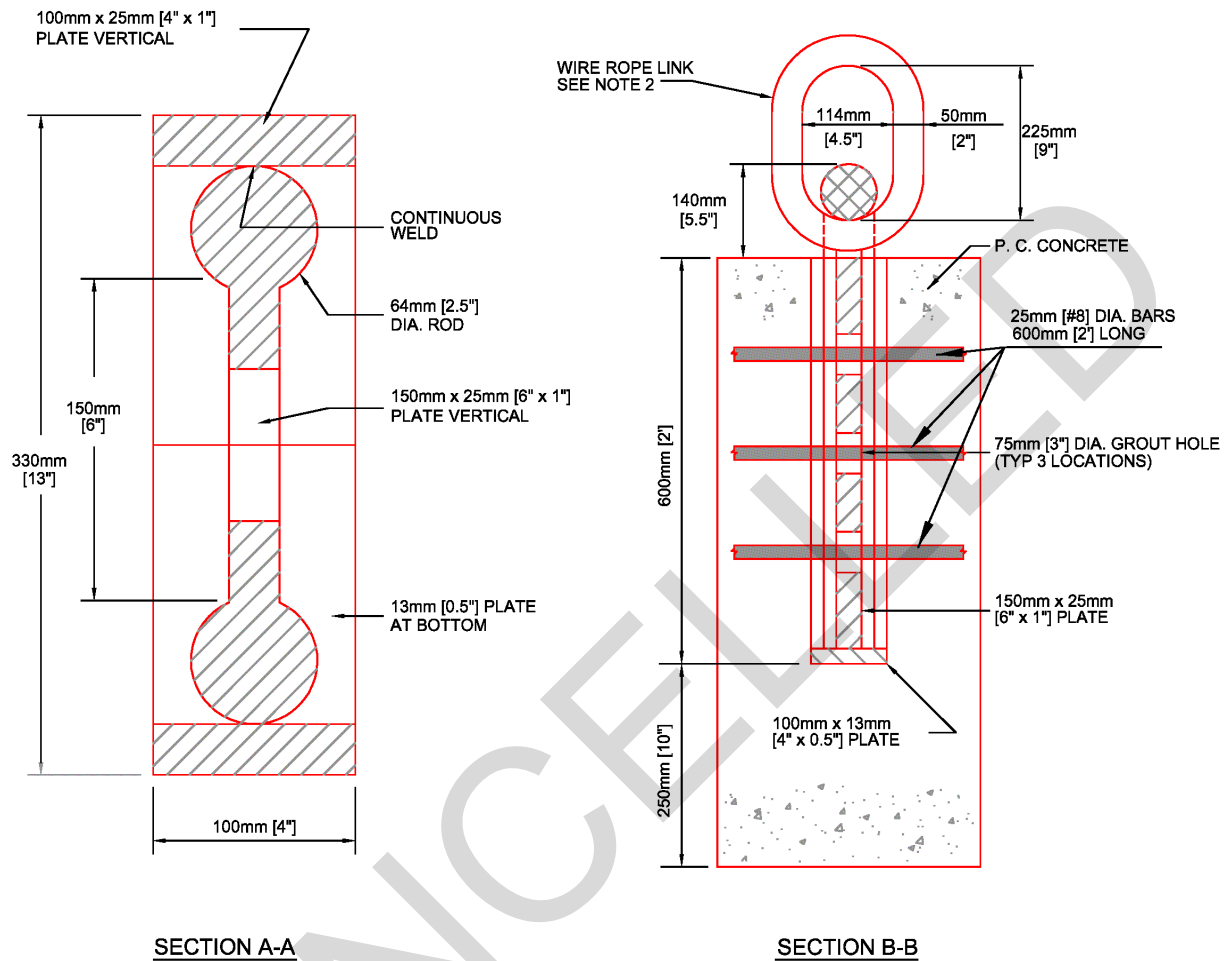

NOTES

1. THIS DESIGN IS FOR UP TO 267,000 N [60,000 LB] THRUST AND WILL ACCOMMODATE FIGHTER AIRCRAFT UP TO AND INCLUDING F-15E. THE DESIGNER MUST VERIFY STRUCTURAL DESIGN FOR THRUST OF DIFFERENT AIRCRAFT AND ENGINE TYPES.
2. DESIGN MAY BE SCALED DOWN TO MEET MISSION AIRCRAFT THRUST LOAD REQUIREMENTS. IF SCALED DOWN, THE ANCHOR MUST BE LABELED WITH THE MAXIMUM THRUST IT IS DESIGNED TO HOLD.
3. WIRE ROPE LINK TO BE CONSTRUCTED OF HIGH-STRENGTH ALLOY WITH MINIMUM YIELD OF 100 KSI, OR USE A LOAD-CERTIFIED COMMERCIAL SHACKLE. ONE SOURCE FOR LOAD-CERTIFIED SHACKLES IS THE CROSBY GROUP INC.
4. ALL STEEL COMPONENTS USED ARE ASTRALLOY V WITH 1,000 MEGAPASCALS [145,000 PSI] YIELD AND 360 MIN BRINELL HARDNESS EXCEPT FOR SHACKLES AND REINFORCING STEEL.
5. ANCHOR ROD SHOULD HAVE A MINIMUM YIELD OF 100 KSI, BE CORROSION RESISTANT, BENDABLE TO THE SPECIFIED RADIUS WITHOUT LOSS OF STRENGTH, HAVE CONSTANT ENGINEERING PROPERTIES TO 537° C, AND POSSESS GOOD FATIGUE CHARACTERISTICS.

Figure B15-3. Example of 267 kN (60,000 lb) Octagonal Anchor Block

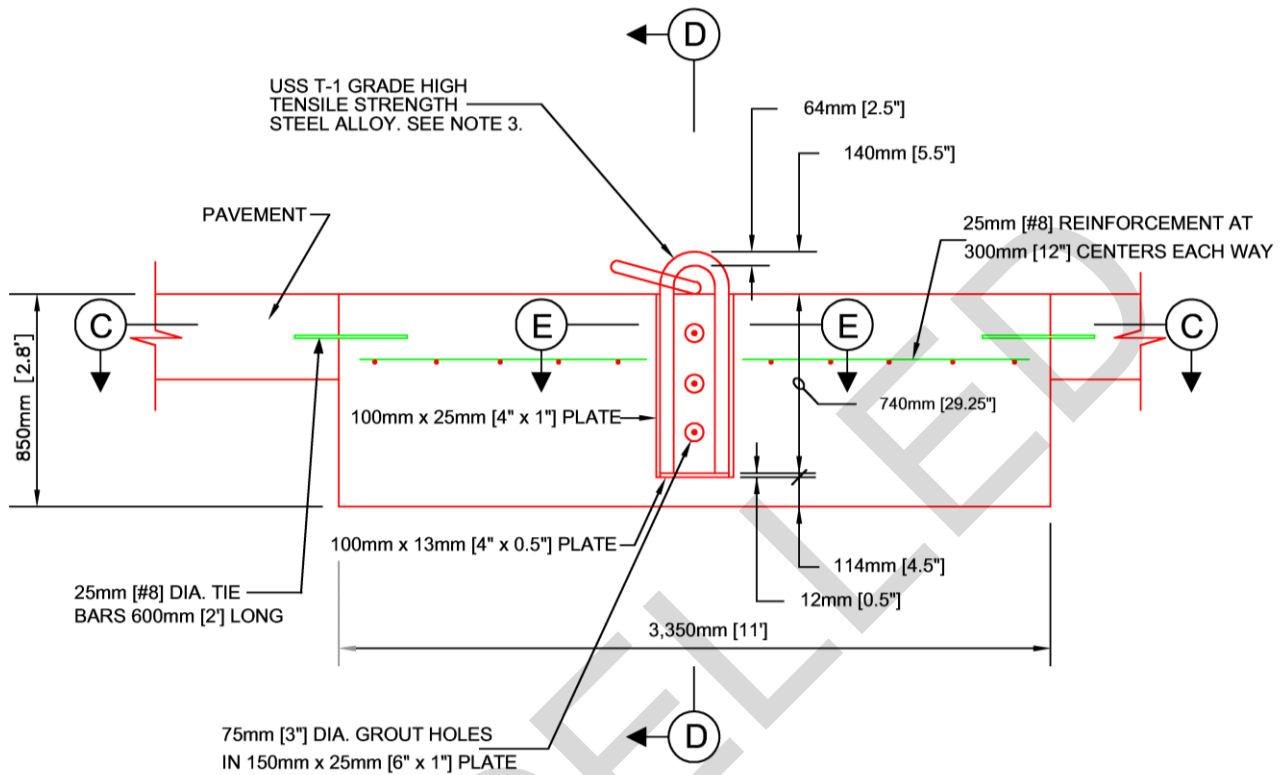

NOTES

1. THIS DESIGN IS FOR UP TO 267,000 N [60,000 LB] THRUST AND WILL ACCOMMODATE FIGHTER AIRCRAFT UP TO AND INCLUDING F-15E. THE DESIGNER MUST VERIFY STRUCTURAL DESIGN FOR THRUST OF DIFFERENT AIRCRAFT AND ENGINE TYPES.
2. SEE FIGURE B15-4 FOR SECTION VIEWS.
3. ANCHOR ROD SHOULD HAVE A MINIMUM YIELD OF 100 KSI, BE CORROSION RESISTANT, BENDABLE TO THE SPECIFIED RADIUS WITHOUT LOSS OF STRENGTH, HAVE CONSTANT ENGINEERING PROPERTIES TO 537° C, AND POSSESS GOOD FATIGUE CHARACTERISTICS.

Figure B15-4. Example of 267 kN (60,000 lb) Octagonal Anchor Block, Cross-Sections C-C, D-D, and E-E

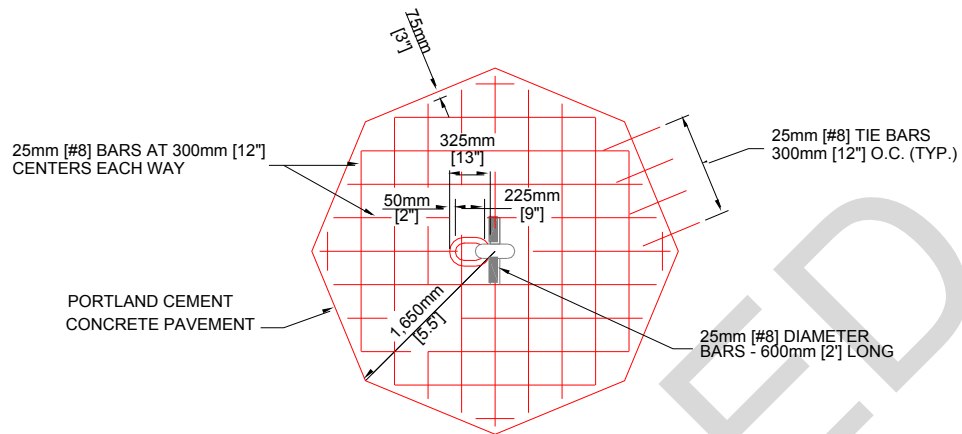

SECTION C-C  
N.T.S.

NOTE

THIS DESIGN IS FOR UP TO 267,000 N [60,000 LB] THRUST AND WILL ACCOMMODATE FIGHTER AIRCRAFT UP TO AND INCLUDING F-15E. THE DESIGNER MUST VERIFY STRUCTURAL DESIGN FOR THRUST OF DIFFERENT AIRCRAFT AND ENGINE TYPES.

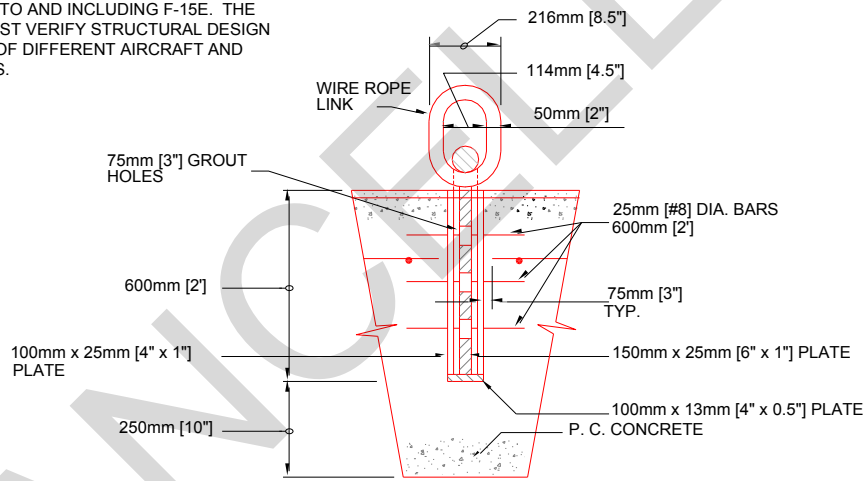

SECTION D-D  
N.T.S.

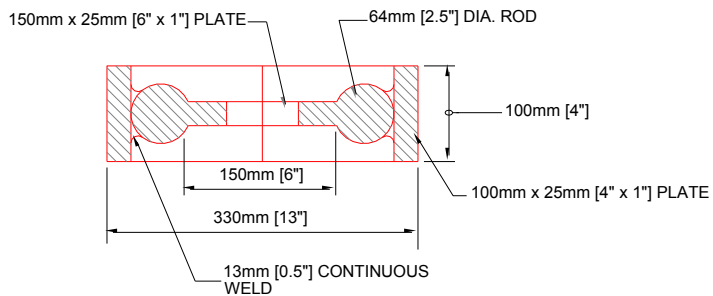

SECTION E-E  
N.T.S.

Figure B15-5. Standard 445 kN (100,000 lb) Thrust Block Steel Anchor

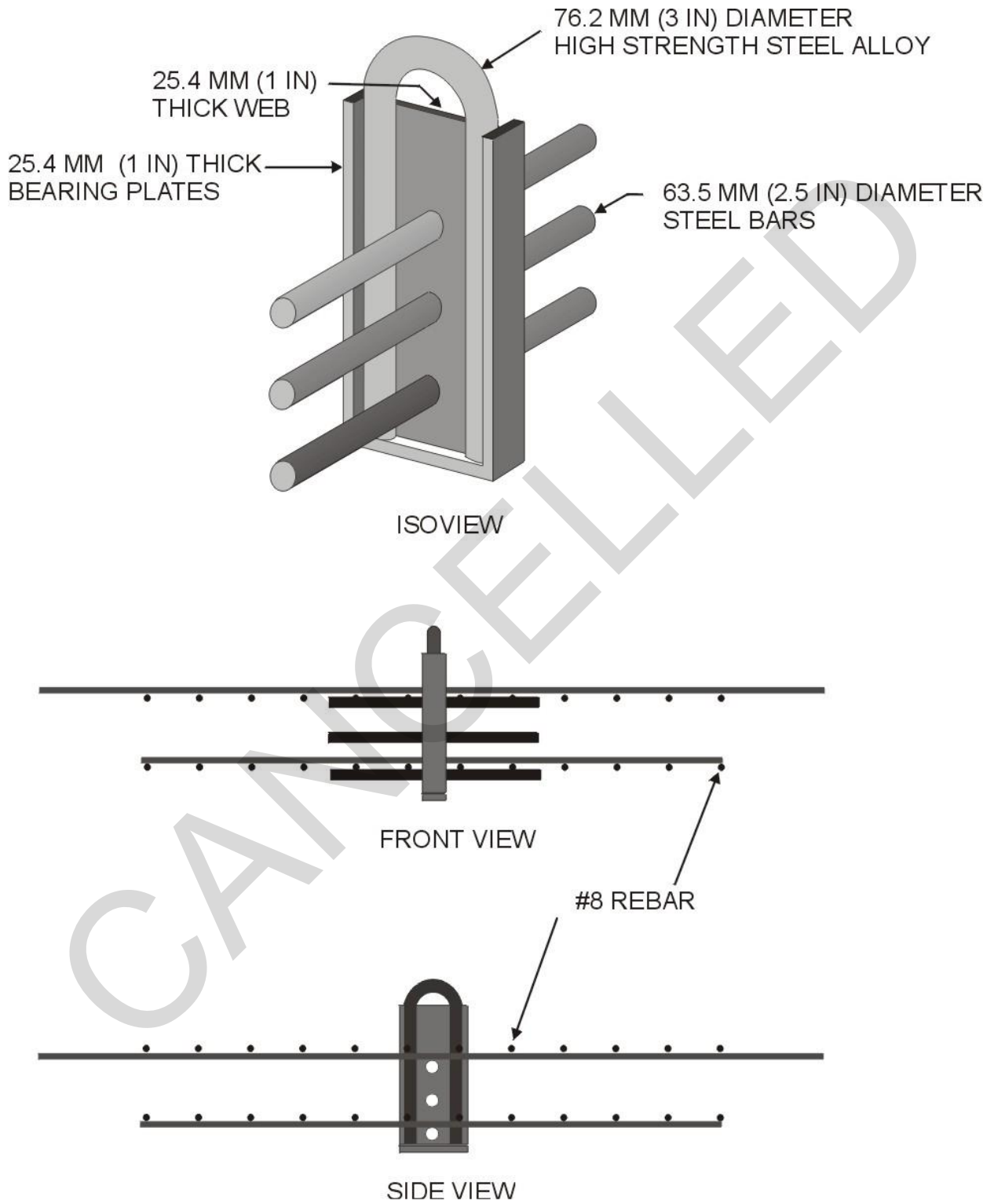

Figure B15-6. Standard 445 kN (100,000 lb) Thrust Block Steel Anchor Dimensions

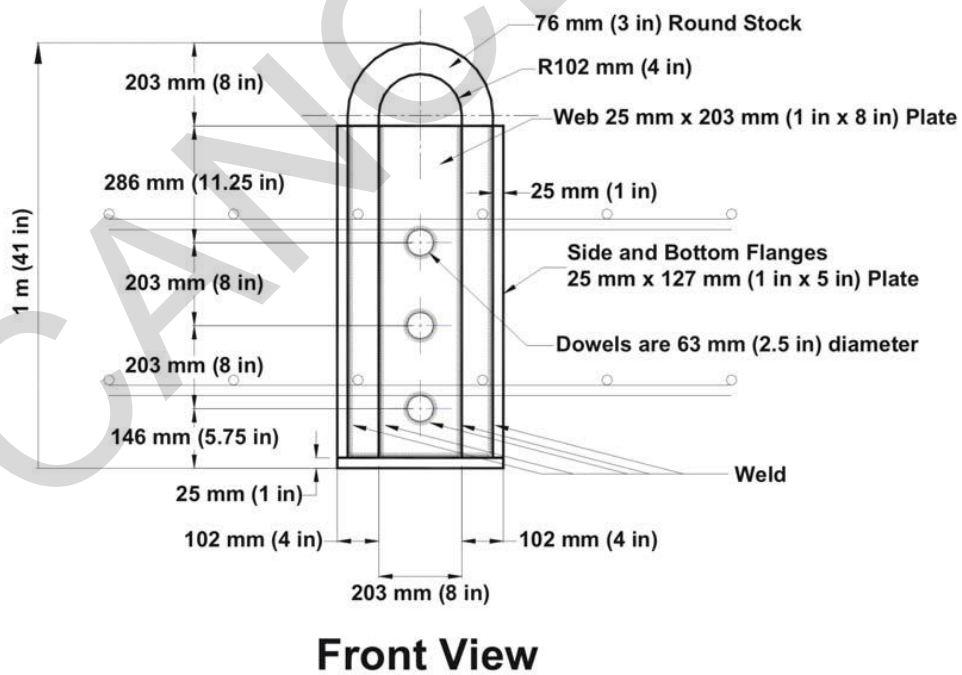
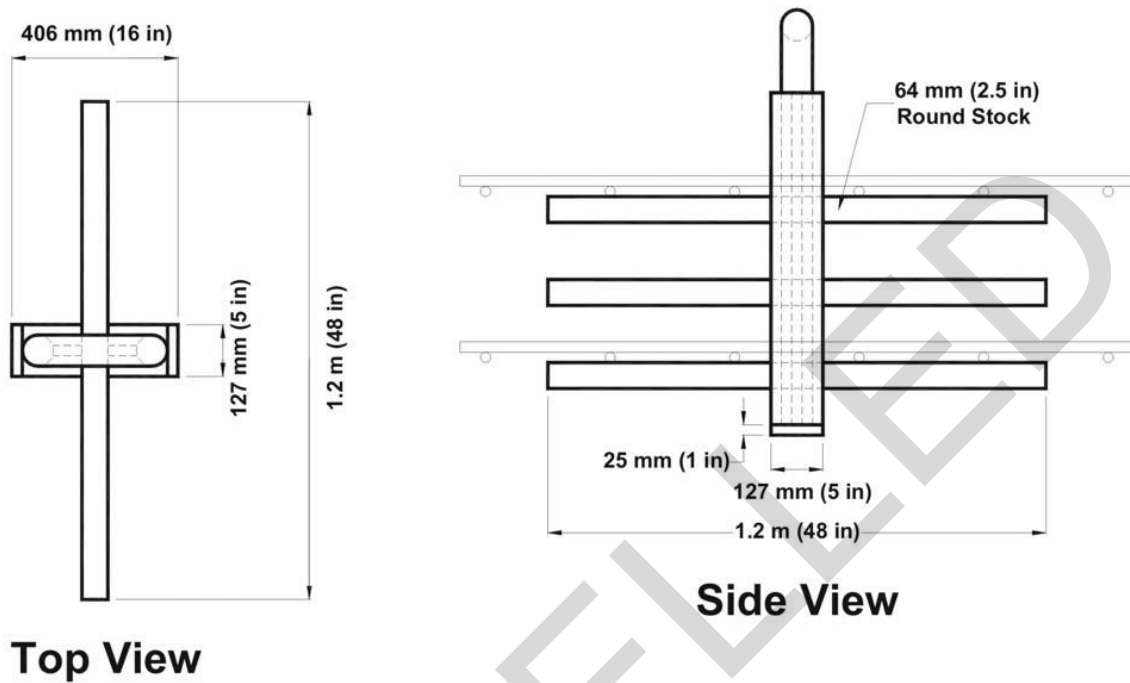

Figure B15-7. Standard 445 kN (100,000 lb) Thrust Concrete Block - Plan View

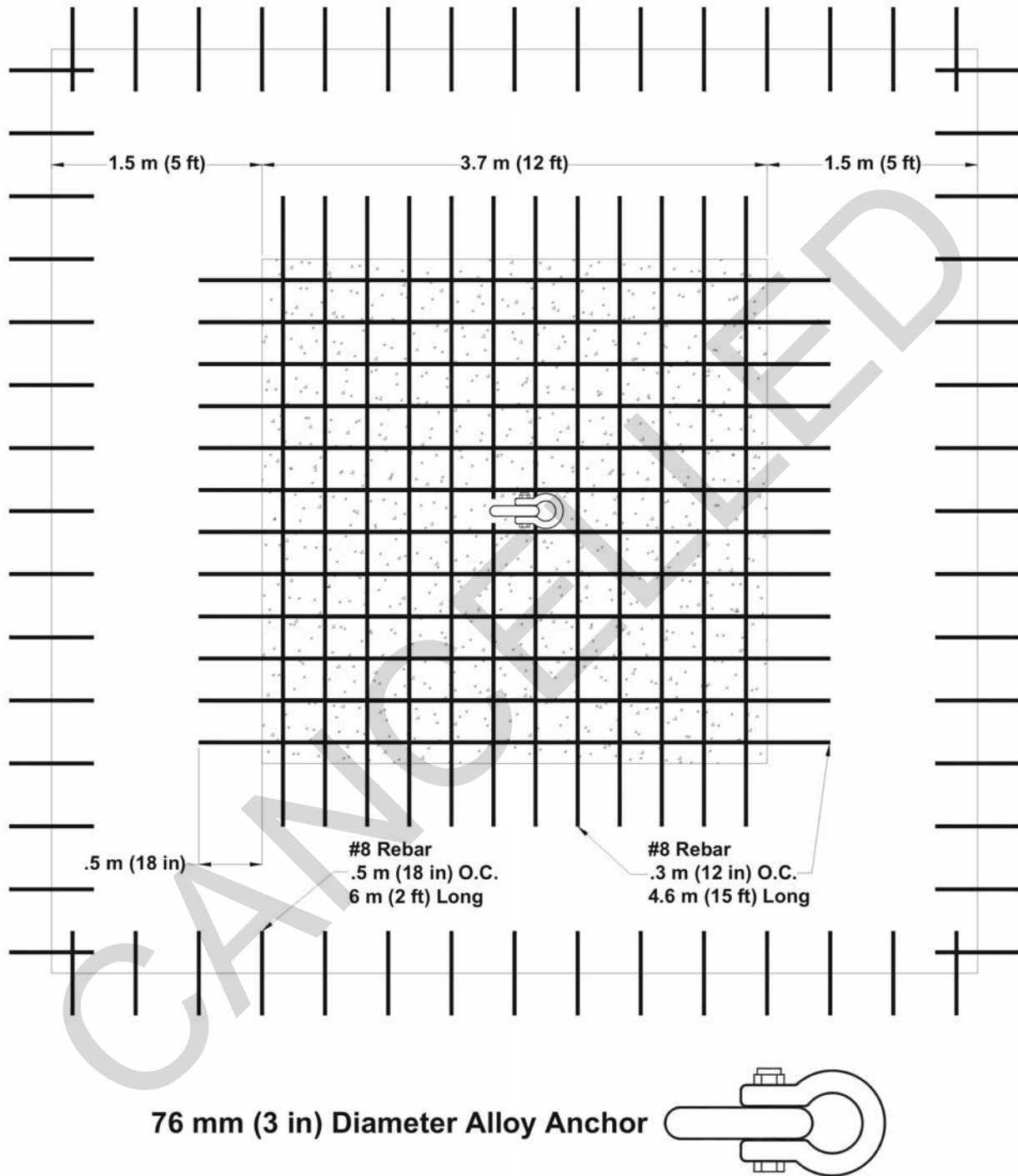
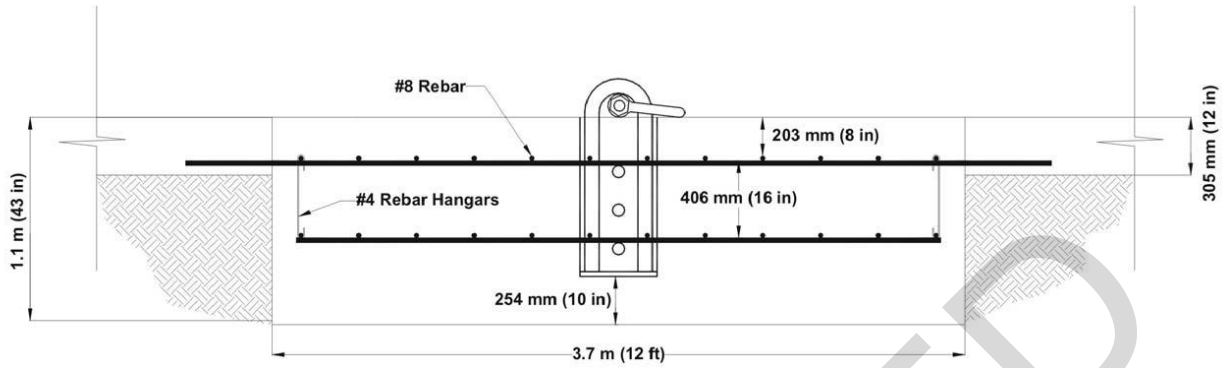

Figure B15-8. Standard 445 kN (100,000 lb) Thrust Concrete Block - Profile View



CANCELLED



**APPENDIX B  
SECTION 16  
AIR TRAFFIC CONTROL TOWER SITING CRITERIA**

**B16-1 GENERAL INFORMATION.**

The Air Traffic Control Tower (ATCT) is the focal point for flight operations within the designated airspace of the installation and for controlling aircraft and vehicles on the airport movement area. Locating and siting an ATCT is a complex procedure that involves many operational and technical requirements. The tower cab must be correctly oriented. The area to be controlled must be visible from the cab. The air traffic controller must have proper depth perception of the area under surveillance, and there can be no electronic interference with equipment in the cab or with navigational equipment on the ground. For these considerations and other operational and technical aspects of selecting a site, consult UFC 4-133-01, *Air Traffic Control and Air Operations Facilities for Service-specific requirements* in the early stages of planning. A site survey will be conducted to determine the best siting for the proposed ATCT. For accurate planning and design considerations, the site survey should be conducted within five (5) years of the projected ATCT construction completion date. See UFC 4-133-01 for specific architectural, structural, mechanical, electrical, and other systems design requirements.

**B16-2 SITING CRITERIA.**

ATCT siting and height determination requires sound engineering principles and close coordination with the host base. Siting project engineers must consider factors that relate to the economics of each candidate site, such as accessibility to utilities, subsoil and ground water conditions, expansion possibilities, as well as selecting a site requiring a tower of the minimum height necessary to meet the specific requirements. The following specific guidelines must be followed:

**B16-2.1 Unobstructed View.**

The air traffic controllers operating this facility must have a clear, unobstructed, and direct view to all operating positions of the airport traffic area; to the approach end of the primary instrument runway; and all other active runways, taxiways, parking aprons, test pads, and similar areas. The ATCT should be located close to runway midpoints and equidistant from other airfield areas to the greatest extent possible.

**B16-2.2 Site Area Requirements.**

The site must provide sufficient area to accommodate the initial building and any planned expansions, including vehicle parking, fuel storage tanks, and exterior transformers.

**B16-2.3 Quantity Distance Criteria.**

See Chapter 1, Paragraph 1-4.1 and Appendix B, Section 9 for additional siting and facility requirements.

#### **B16-2.4 Obstruction Clearance.**

As a minimum, the site must conform to ground system and obstruction clearance criteria for Category II Instrument Landing Operations (see FAA Handbook [FAAH] 7110.65 and AFI 11-230).

#### **B16-2.5 Siting Effects on NAVAIDS.**

The ATCT must be sited where it will not detract from the performance of existing or planned electronic air navigational facilities (terminal very high frequency omnirange [TVOR], airport surveillance radar [ASR], and tactical air navigation [TACAN]). There are no criteria that establish minimum distances from electronic air navigational facilities. However, the facilities most likely to be affected are the TVOR, TACAN, and ASR. The ATCT should be no closer than 450 meters (1,500 feet) from these three facilities. Other electronic air navigation facilities (e.g., precision approach radar, ILS) are not as likely to be affected because their usage is more directed along the runway's major axis. However, care should be taken in siting the ATCT so it does not conflict with proper operation of these facilities.

#### **B16-2.6 Siting for Proper Depth Perception.**

Sufficient depth perception of all surface areas to be controlled must be provided. This is the ability to differentiate the number and type of grouped aircraft and ground vehicles and to observe their movement and position relative to the airfield surface areas. Proper depth perception is provided when the controller's line-of-sight is perpendicular or oblique to the line established by aircraft and ground vehicle movement, and where the line-of-sight intersects the airfield surface at a minimum vertical angle of 35 minutes, with an objective target of 48 minutes vertical angle. Required eye level elevation is determined using the following formula:

$$E_e = E_{as} + D \tan (VA + G_s)$$

Where:

$E_e$  = Eye-level elevation (1.5 m [5 ft] above control cab floor).

$E_{as}$  = Average elevation for section of airfield traffic surface in question.

$D$  = Distance from proposed tower site to section of airfield traffic surface in question.

$G_s$  = Angular slope of an imaginary line from the surface of the airfield to the base of the tower, determined by the difference in elevation and the distance between, measured in minutes) (negative value if slope is downward towards the tower, positive value if slope is upward towards the tower).

$VA$  = Line of Sight Vertical Angle. 35 minutes minimum, 48 minutes optimum.

**B16-2.7 Compliance with Airfield Standards.**

Siting should conform to airfield and airspace criteria in Chapter 3. Deviations should only be considered when they are absolutely necessary. Any siting deviations that would normally require a waiver must be subjected to a TERPS analysis performed by the appropriate service specific office. If the analysis reveals that the ATCT will not adversely affect instrument procedures, the ATCT siting may be considered a permissible deviation with proper service-specific coordination per Chapter 1, Paragraph 1-7.

**B16-2.8 Orientation of the Control Cab.**

Siting should provide an acceptable orientation of the ATCT Control Cab. The preferred Cab orientation in relation to the runway is obtained when the long axis of the equipment console is parallel to the primary runway. The reason for this orientation is to allow controllers to face the runway and the ATCT instrument panel without frequently turning their heads to observe events on the runway. Preferred direction should be north (or alternatively, east, south, or west, in that order of preference) when sited in the Northern Hemisphere. Locations that place the runway approach in line with the rising or setting sun should be avoided.

**B16-2.9 Extraneous Lighting.**

Siting should be such that visibility is not impaired by external lights such as floodlights on the ramp, rotating beacons, reflective surfaces, and similar sources.

**B16-2.10 Weather Phenomena.**

Siting should consider local weather phenomena to keep visibility restriction due to fog or ground haze to a minimum.

**B16-2.11 Exhaust Fumes and other Visibility Impairments.**

Siting should be in an area relatively free of jet exhaust fumes and other visibility impairments such as industrial smoke, dust, and fire training areas.

**B16-2.12 Avoid Sources of Extraneous Noise.**

The ATCT should be sited in an area where exterior noise sources are minimized. Special efforts should be made to separate the ATCT from aircraft engine test cells, engine run-up area, aircraft parking areas, and other sources of noise.

**B16-2.13 Personnel Access Considerations.**

Efforts should be made to site the ATCT so that access can be gained without crossing areas of aircraft operations.

**B16-2.14 Compliance with the Comprehensive Plan.**

Siting should be coordinated as much as possible with the base comprehensive plan. Particular attention should be given to future construction (including additions or extensions) of buildings, runways, taxiways, and aprons to preclude obstructing controller visibility at a future date.

**B16-2.15 Consider the Effects on Meteorological and Communications Facilities.**

The ATCT should be sited so it is free of interference from or interference with existing communications-electronics meteorology or non-communications-electronics meteorology facilities. If an acceptable location is not otherwise obtainable, consider relocating these facilities.

**Figure B16-1. Runway Profile and New Control Tower**

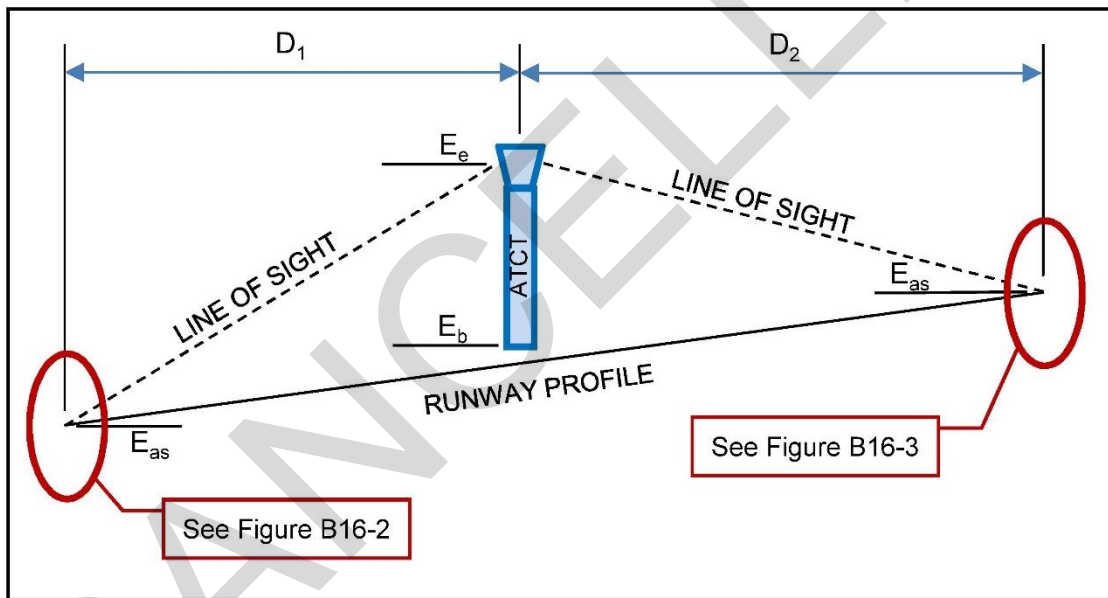
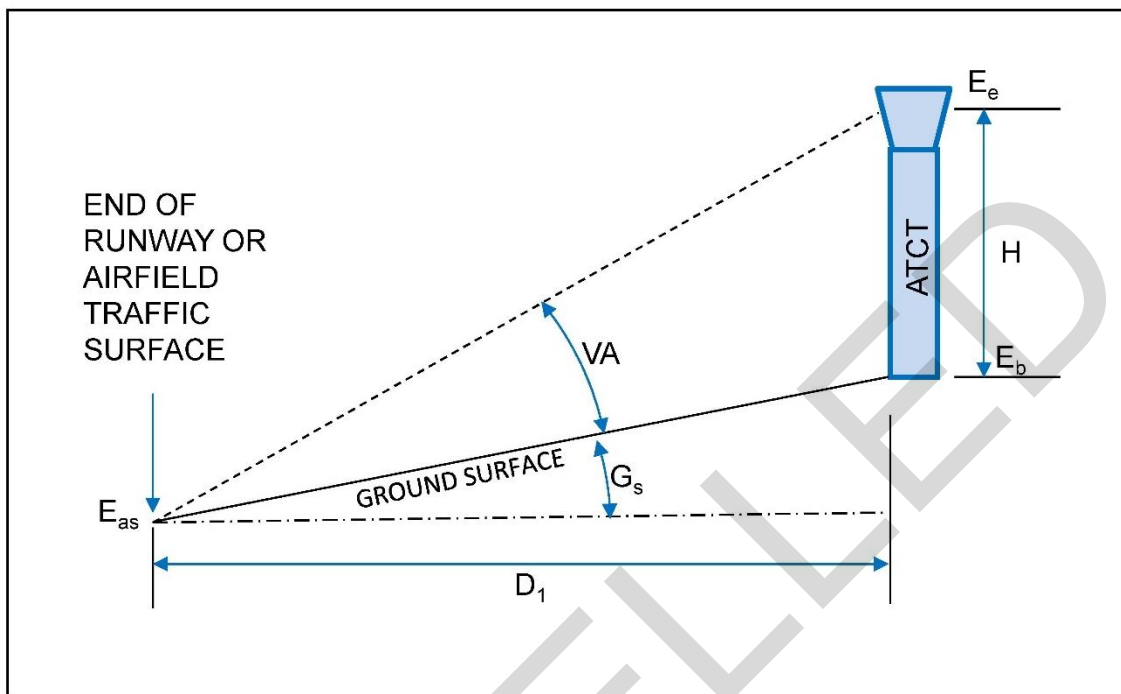

Figure B16-2. Minimum Eye-Level Determination – Tower Higher than Runway End



Given:  $E_{as} = 30.5 \text{ m (100') MSL}$   $E_b = 32.3 \text{ m (106') MSL}$   
 $D_1 = 1,828.8 \text{ m (6,000')}$   
 $G_s = +2 \text{ min}$   
 $VA = 35 \text{ minutes (to reflect minimum requirement)}$

Find  $E_e$  :

$$\begin{aligned} E_e &= 30.5 \text{ m (100')} + H \\ &= 30.5 \text{ m (100')} + (1,828.8 \text{ m (6,000')} \times \tan (35 \text{ min} + 2 \text{ min})) \\ &= 30.5 \text{ m (100')} + (1,828.8 \text{ m (6,000')} \times 0.01076) \\ &= 30.5 \text{ m (100')} + 19.7 \text{ m (64.6')} \\ &= 50.2 \text{ m (164.6') MSL} \end{aligned}$$

Minimum Required Eye Level Height =  $E_e - E_b = 50.2 \text{ m (164.6')} - 32.3 \text{ m (106.0')} = 17.9 \text{ m (58.6')}$

Figure B16-3. Minimum Eye-Level Measurement – Tower Lower than Runway End

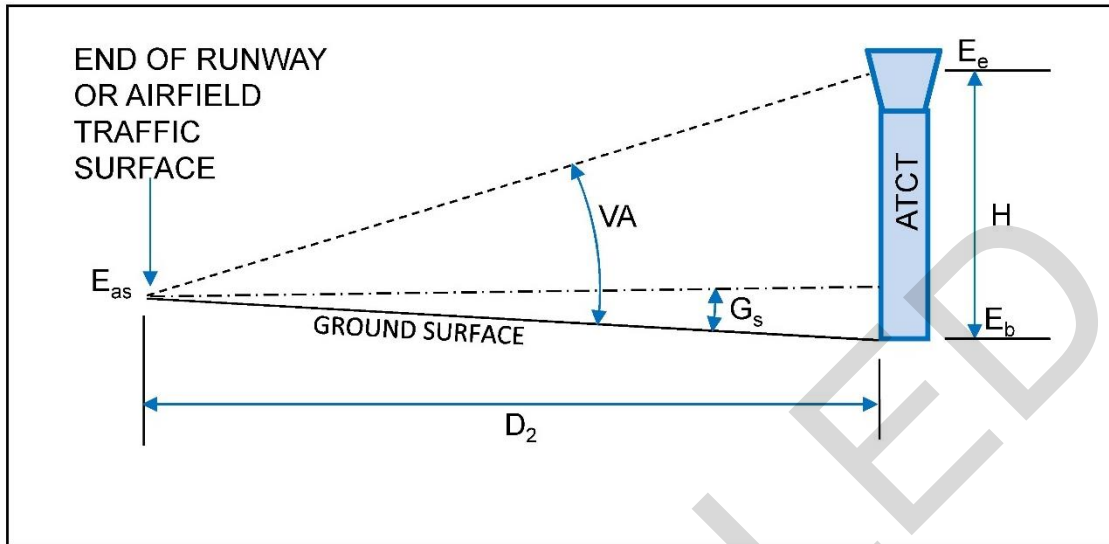

Given:  $E_{as} = 33.5 \text{ m (110') MSL}$   $E_b = 32.3 \text{ m (106.0') MSL}$   
 $D_2 = 1,828.8 \text{ m (6,000')}$   
 $G_s = -2 \text{ min}$   
 $VA = 35 \text{ minutes (to reflect minimum requirement)}$

Find  $E_e$  :

$$\begin{aligned}
 E_e &= 33.5 \text{ m (110')} + H \\
 &= 33.5 \text{ m (110')} + (1,828.8 \text{ m (6,000')} \times \tan (35 \text{ min} - 2 \text{ min})) \\
 &= 33.5 \text{ m (110')} + (1,828.8 \text{ m (6,000')} \times 0.0096) \\
 &= 33.5 \text{ m (110')} + 17.6 \text{ m (57.6')} \\
 &= 51.1 \text{ m (167.6') MSL}
 \end{aligned}$$

Minimum Required Eye Level Height =  $E_e - E_b = 51.1 \text{ m (167.6')} - 32.3 \text{ m (106.0')} = 18.8 \text{ m (61.6')}$

CONCLUSIONS:

- 18.8 m (61.6') height is larger and therefore controls.
- Eye height to cab ceiling is 2.1 m (7'); therefore, the overall height is 2.1 m (7') + 18.8 m (61.6') = 20.9 m (68.6').
- In this case, minimum tower height of 20.4 m (67') will not satisfy requirements (see Figure B16-3). Therefore, in order to meet the minimum 35-minute depth perception requirement, an additional floor must be added to increase the overall height of the proposed control tower.

**B16-3 MINIMUM REQUIRED FLOOR LEVELS.**

See UFC 4-133-01, *Air Traffic Control and Air Operations Facilities* for specific architectural, structural, mechanical, electrical and other systems design requirements.

**B16-4 SITING PROCEDURES**

The project siting engineer, in determining the site recommendation, should fix the ATCT siting and height to the cab floor with assistance from and concurrence of base communications (plans and programs), base airfield operations flight (control tower and airfield management), and base civil engineering offices. The project engineer for support equipment installation will establish internal ancillary equipment requirements based on an assessment of operational needs. Suggested procedures for selecting an ATCT site are in paragraphs B16-4.1 and B16-4.2.

**B16-4.1 Office Study by Siting Engineers.**

- a. Using elements of the most up-to-date base comprehensive plan, make tentative site selections. Using elements of the base comprehensive plan and the 35-minute depth perception requirements, determine the approximate ATCT height for each tentative site selected.
- b. Analyze more than one tentative site if appropriate.

**B16-4.2 Field Study by Siting Engineers.**

- a. Conduct field review of the office-selected tentative sites plus other sites that merit consideration based on discussions with base organizations and the on-location surveys. Consider both siting requirements and siting considerations previously discussed.
- b. Consider in the survey of each site the availability and cost of access roads, utility extensions, and communications cable relocations. Also, evaluate each site to determine the adequacy of ground conditions for structural support of the ATCT, drainage characteristics, and availability of utilities.
- c. Use profile drawings and shadow maps to determine areas of visibility restrictions due to other structures.
- d. If available and practical, obtain panoramic pictures taken at the proposed ATCT Control Cab eye level at each tentative site. Photographs should be in color and oriented to true north to allow precise interpretation of the surfaces and objects viewed and for complete 360-degree horizontal plane around the site. Suggested methods of taking pictures are from a helicopter, cherry picker, or crane boom.

- e. Consider the environmental impact of each site. The Environmental Impact Analysis Process (EIAP) is accomplished through the local installation.

#### **B16-4.3 TERPS Analysis.**

To determine if a new ATCT will be an obstruction factor, TERPS shall evaluate the proposed ATCT location and final elevation and determine its effect on all existing or planned instrument procedures. Penetrations of the transitional surface may not necessarily affect instrument procedures.

**NOTE:** ATCTs will not be sited within the primary surface from a runway centerline except at locations required to operate under International Civil Aviation Organization (ICAO) standards. At these locations, the ATCT must be located at least 228.6 meters (750 feet) from the runway centerline.

#### **B16-5 SITE RECOMMENDATIONS.**

On completing the field study, siting participants should evaluate each alternative location and should recommend a site. The project siting engineer should then compile all siting data, comparisons, and determinations (including the siting recommendation) in a Statement of Intent (SOI). If practical, the SOI should be signed by all participating personnel, the base communications officer, and the base commander. If practical, the SOI must be completed and signed by appropriate personnel before completing the field study. The SOI should include the following:

- Siting recommendation: location, orientation, and height.
- Data comparisons and determinations made during field study.
- Reasons for deviations, if any, from siting requirements.
- Panoramic pictures, if available.
- Economic evaluations, if applicable.
- Major construction requirements to support communications-electronic (C-E) equipment, if applicable.
- Other special considerations.

#### **B17-6 SOI DISTRIBUTION.**

The SOI should be distributed to all signatories. Copies should be retained by the appropriate installation planning, communications, and airfield operations flight offices. Copies should be sent to the appropriate Service program authorities. After agreement to a siting recommendation, the host base submits the siting plan to the appropriate Service program authorities for approval. A sample of an SOI is shown below.

#### **B17-7 SAMPLE SOI.**



This is a Statement of Intent (SOI) between (enter name of Service program authority) and (enter name of appropriate installation entity) as it pertains to the (enter date) Site Survey for the proposed new Air Traffic Control Tower at (enter appropriate installation).

The purpose of this SOI is to reserve the area required for this project, to note the major allied support requirements needed for later installation of the project equipment, and to serve as a source document for preparation of the planning documents.

This survey considers (enter appropriate number) possible ATCT locations:

- Site No. 1: (describe location)
- Site No. 2: (describe location)
- Site No. 3: (describe location)

#### **B16-7.1 Site Numbers.**

(Insert appropriate numbers) were rejected for the following reasons:

Site No. \_\_\_\_\_: (Insert reasons for rejection)

Site No. \_\_\_\_\_: (Insert reasons for rejection)

Based on the results of this survey, it is recommended that Site Number \_\_\_\_\_ be selected for the new ATCT location. The following rationale supports this recommendation: (Insert rationale.)

The ATCT will be designed using the \_\_\_\_\_ ATCT as a guide. The height of the control ATCT will be (insert height in meters [feet]). See attached sketch. This height is necessary to provide adequate visibility for taxiways/runways and to provide the minimum angle of 35 minutes for depth perception to the farthest aircraft traffic surface on the airdrome.

#### **B16-7.2 Allied Support Requirements**

##### **B16-7.3 Utilities.**

Electrical power shall be (insert appropriate voltage and frequency), plus or minus 10 percent, three-phase, four wire to the ATCT. Other electrical utility power for mechanical systems shall be (insert appropriate voltage and frequency) to support requirements.

##### **B16-7.3.1 Environmental Requirements.**

Environmental control is required in the ATCT Control Cab and the electronic equipment rooms in order to sustain effective and continuous electronic equipment operation. The operational limits and the amount of heat dissipated by the equipment are as follows:

Room Heat Dissipated Temp/Humidity

ATCT Control Cab \_\_\_\_\_ BTU \_\_\_\_\_ / \_\_\_\_\_

Upper Equipment Room \_\_\_\_\_ BTU \_\_\_\_\_ / \_\_\_\_\_

Lower Equipment Room \_\_\_\_\_ BTU \_\_\_\_\_ / \_\_\_\_\_

Other Equipment Room \_\_\_\_\_ BTU \_\_\_\_\_ / \_\_\_\_\_

**B16-7.3.2 Field Lighting Panel.**

A field lighting panel, connected to the night lighting vault, will be required for this new structure.

**B16-7.3.3 Communications.**

All existing communication lines/circuitry for NAVAID monitors and radio transmitters/receivers now terminated in the existing ATCT shall be provided to the new ATCT.

**B16-7.3.4 Underground Duct.**

The existing base duct system must be extended to the proposed ATCT site for the field lighting cables, primary power cables, control cables, telephone cables, and meteorological cables.

- a. After the ATCT project has become a firm MCP item, programming action should be initiated by the base Communications department to relocate the electronic equipment from the existing ATCT to the new ATCT.
- b. Points of contact concerning the survey are \_\_\_\_\_.

**APPENDIX B  
SECTION 17  
GUIDELINES FOR ESTABLISHING BUILDING  
RESTRICTION LINE AT AIR FORCE BASES**

**B17-1 OVERVIEW.**

In January 2000, the Chief of Staff directed formation of an Air Force tiger team to address reducing the number of airfield obstructions. To facilitate this effort, the Deputy Chiefs of Staff for Operations, Safety, and Civil Engineering directed that the MAJCOMs provide a listing of airfield obstructions at their bases, along with a cost estimate to remove them. Because many of the obstructions listed were high-cost facilities that were constructed under previous less-stringent standards, and therefore exempt from compliance with current standards, HQ USAF/XOO and ILE issued a policy memorandum directing that all bases must establish building restriction lines (BRL) at the predominant line and height of flight-line facilities. This policy memorandum also authorized further development within the boundaries established by the BRLs without waiver. The guidelines they established for creating the BRLs are provided below to establish a record of the rationale used to accomplish this work and the policy for continued growth within the exempt area. Policy for future modification of BRLs was added to these guidelines for publication within this UFC. See paragraph B17-7.

**B17-1.1 General Information.**

The BRL is defined as "a line which identifies suitable building area locations on airports." For civilian airports, it is described in FAA AC 150/5300-13. For Air Force installations, the BRL will have the same meaning; however, it will be established at a different location than at civilian airports. Generally, the distance from the runway centerline will be greater. However, in some cases, it may be slightly less than it would be if established in accordance with civil standards.

**B17-1.2 Purpose.**

The purpose in establishing BRLs on Air Force bases is to identify the area where facilities were constructed under previous standards (exempt facilities) and eliminate waivers for other facilities constructed within this area after the lateral clearance distance standards changed in 1964. (Facilities constructed under previous standards that were consciously omitted from the confines of the BRL must be carried as waivers.) This clarifies existing policy for exempt facilities and creates new policy for new construction and land use to allow continued but controlled development without waiver. This will significantly reduce the administrative burden imposed by the airfield waiver program without increasing risk to flight or ground safety. It will allow continued growth at bases with land constraints and will continue to protect existing airspace. Use the following information to establish the BRL.

**B17-2 ESTABLISHING THE BRL AT A BASE.**

Establish the BRL laterally from the runway centerline at the predominant line of facilities. The lateral line may have right angles that form indentations or pockets but must exclude all objects and/or facilities that affect existing or planned Terminal Approach and Departure Procedures (TERPS) criteria for your runway, and the 914-meter by 914-meter (3,000-foot by 3,000-foot) clear zone area. See Figure B17-1 for a plan view of a typical BRL. Using the same methodology as described above, establish an elevation control line at the predominant roofline of the facilities within the area formed between the lateral BRL and the lateral clearance distance boundary or the transitional surface, as applicable. The longitudinal slope of the elevation control line should match the slope of the primary surface. This elevation control line will terminate laterally at its intersection with the transitional surface, or at the base boundary, whichever occurs first. See Figure B17-2 for a profile view of a typical BRL.

**B17-3 STATUS OF EXISTING AND FUTURE FACILITIES AND OBSTRUCTIONS WITHIN THE AREA.**

All facilities beyond and beneath the control lines will be exempt from waiver and obstruction marking and lighting requirements. However, it is imperative that obstruction lighting be maintained along the periphery of the BRL control line. Therefore, maintain obstruction marking and lighting on the facilities used to form the BRL. New facilities constructed at the outer or uppermost limits of the BRL must also be marked and lighted, and appurtenances that extend above the elevation control line must be marked and lighted as obstructions, regardless of their location. Waivers must be maintained for facilities or obstructions that affect instrument procedures (TERPS) and these obstructions must be marked and lighted in accordance with AFI 32-1042 and UFC 3-535-01. Obstacles that are behind and beneath the facilities may not need obstruction lights if they are shielded by other obstacles.

**B17-4 FUTURE DEVELOPMENT OF AREA WITHIN BRL CONTROL LINES.**

**B17-4.1 Future Construction.**

Future construction within this area is allowed, but only for flightline-related facilities within the following category groups:

- 11, Airfield Pavements
- 12, Petroleum Dispensing and Operating Facilities
- 13, Communications, Navigational Aids, and Airfield Lighting
- 14, Land Operations Facilities
- 21, Maintenance Facilities
- 44 and 45, Storage Facilities Covered, Open and Special Purpose
- 61, Administrative Facilities
- 73, Personnel Support

- 85, Roadway Facilities
- 86, Railroad Trackage
- 87, Ground Improvement Structures.

Utilities and ancillary systems for these types of structures are authorized. See AFH 32-1084 for additional information.

**B17-4.2 Existing Facilities.**

Existing facilities that are not within the category groups listed above may remain within the exempt zone created by establishing the BRL control lines. However, they must be relocated outside of this area when the facility is replaced.

**B17-5 FUTURE MODIFICATION TO BRL.**

BRLs may not be modified after they are established except to remove them from the airfield obstruction map if and when all exempt facilities are eventually relocated or to reduce the size of the area encompassed by the BRL as buildings are relocated.

CANCELLED

Figure B17-1. BRL – Plan View

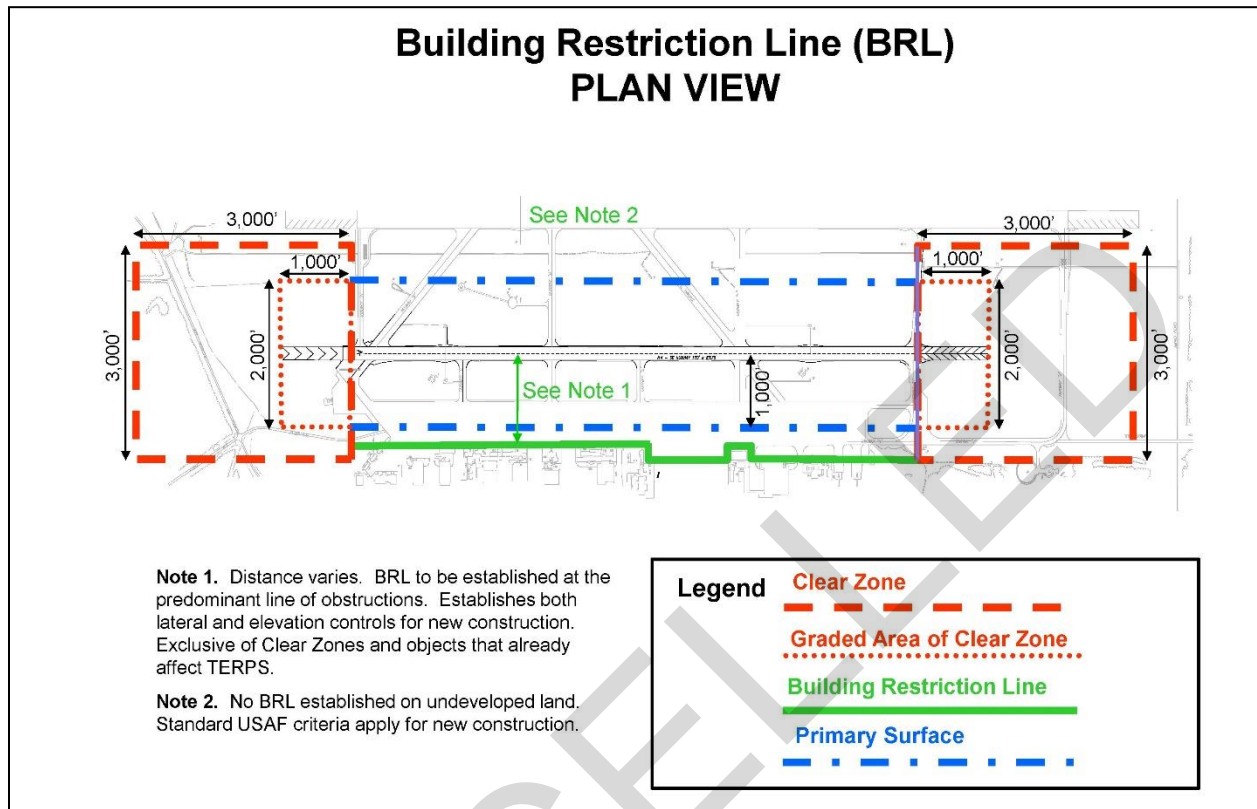
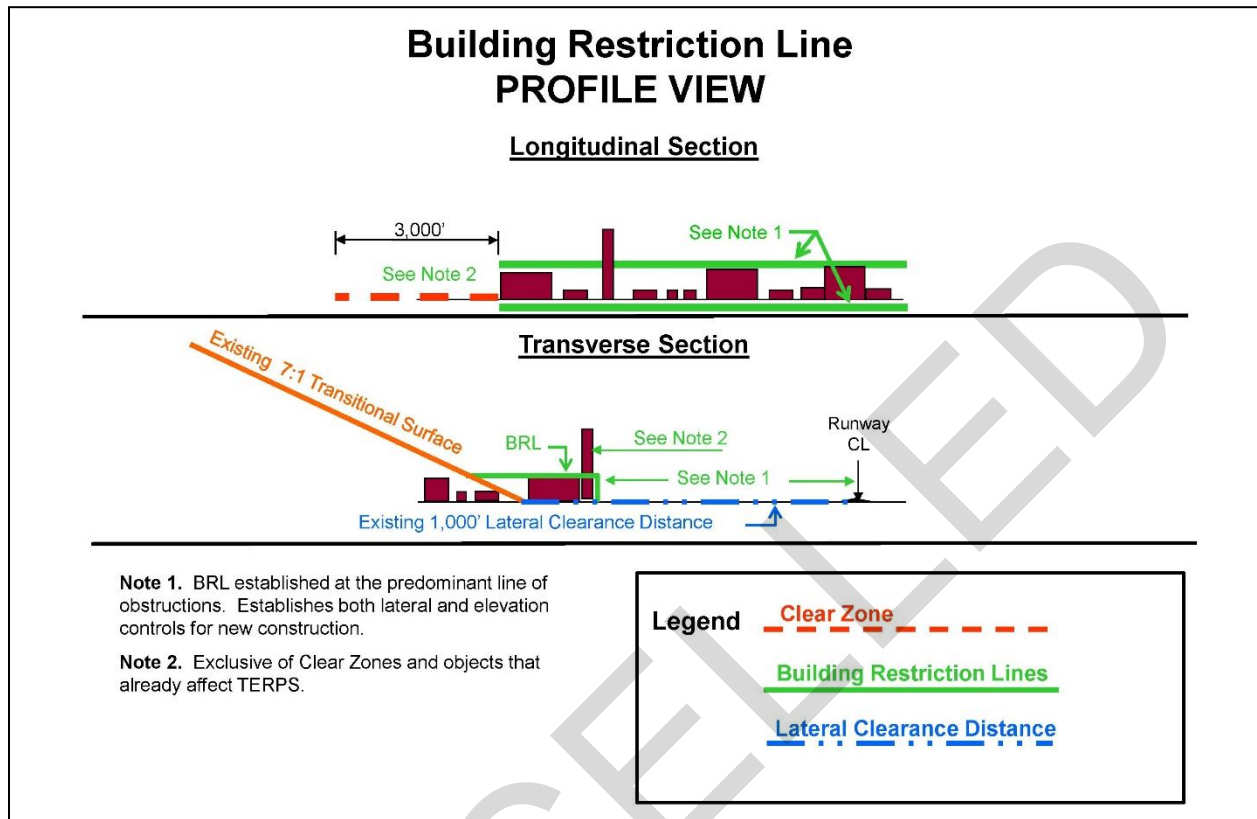

Figure B17-2. BRL – Profile View



THIS PAGE INTENTIONALLY BLANK

CANCELLED



**APPENDIX C  
GLOSSARY**

**AASHTO**—American Association of State Highway and Transportation Officials

**AAF**—Army Airfield

**AC**—Advisory Circular

**AC**—alternating current

**ACN**—Aircraft Classification Number

**ACOM**—Army Command

**ADCS**—Approach-Departure Clearance Surface

**AFCEC**—Air Force Civil Engineer Center

**AFB** – Air Force Base

**AFFSA**—Air Force Flight Standards Agency

**AFH**—Air Force handbook

**AFI**—Air Force instruction

**AFIMSC**—Air Force Installation Mission Support Center (Air Force)

**AFJMAN**—Air Force joint manual

**AFJPAM**—Air Force joint pamphlet

**AFM**—Air Force manual

**AFMAN**—Air Force manual

**AFPD**—Air Force Policy Directive

**AFR**—Air Force regulation

**AFRC**—Air Force Reserve Command

**AGL**—above ground level

**A/G**—arresting gear

**AH**—attack helicopter

**AICUZ**—air installations compatible use zones

**ALZ**—assault landing zone

**AM**—airfield manager

**AMC**—Air Mobility Command

**AMSL**—above mean sea level

**AMP**—airfield marking pattern

**ANG**—Air National Guard

**AOA**—aircraft operating area

**AORI**—Airfield Obstruction Reduction Initiative

**APOE**—aerial ports of embarkation

**APOE/D**—aerial ports of embarkation/debarkation

**APOD**—aerial ports of debarkation

**APZ**—accident potential zone

**APZ I**—accident potential zone I

**APZ II**—accident potential zone II

**APZ-LZ**—accident potential zone—landing zone

**AR**—Army regulation

**ARAC**—Army Radar Approach Control

**ARNG**—Army National Guard

**ASC/658 AESG** – Aeronautical Systems Center, 658 Aeronautical Systems Group

**ASCC**—Army Service Component Command

**ASOS**—automatic surface observation station

**ASR**—airport surveillance radar

**ASV**—annual service volume

**AT&A**—air traffic and airspace

**ATC**—air traffic control

**ATCAL**S—air traffic control and landing systems

**ATCT**—air traffic control tower

**ATIS**—automatic terminal information service

**ATNAVICS**—Air Traffic Navigation, Integration and Coordination System

**ATSCOM**—Air Traffic Services Command

**AVGAS**—aviation gasoline

**AVIM**—Aviation Intermediate Maintenance

**AVUM**—Aviation Unit Maintenance

**AWS**—air weather service

**BAK**—barrier, arresting kit

**BASH**—bird/animal strike hazard

**BCE**—base civil engineer

**BRL**—building restriction lines

**CAIMOD2**—close-in approach indicator

**CARC**—chemical agent-resistant coating

**CAT I ILS**—category I instrument landing system

**CAT II ILS**—category II instrument landing system

**CATEX**—categorical exclusion

**CBR**—chemical, biological, radiological

**CCA**—carrier controlled approach

**CCP**—compass calibration pad

**C-E**—communications-electronic

**CFR**—Code of Federal Regulations

**CH**—cargo helicopter

**CIP**—common installation picture

**CNO/CMC**—Chief of Naval Operations/Commandant Marine Corps

**COE TSC**—Corps of Engineers Transportation Systems Center

**CONOPS**—concept of operations

**CONUS**—continental United States

**CRHTC**—continuously reinforced high temperature concrete

**CVN**—aircraft carrier

**CVW**—carrier air wing

**CZ**—clear zone **DA**—decision altitude

**DA**—Department of the Army

**DAPAM**—Department of the Army pamphlet

**DASR**—digital airport surveillance radar

**dB(a)**—decibel

**DC**—direct current

**DFP**—defensive fighting position

**DH**—decision height

**DIA**—diameter

**DM**—design manual

**DME**—distance measuring equipment

**DNL**—Day-night average sound level

**DO**—director of operations

**DOB**—deployed operating base

**DoD**—Department of Defense

**DoDD**—DoD Directive

**DoDI**—DoD Instruction

**DPTM**—Aviation Division, Directorate of Plans, Training and Mobilization (Army)

**DPW**—Department of Public Works

**DRMO**—Defense Reutilization and Marketing Office

**DRU**—Direct Reporting Unit

**Du/Ac**—dwelling units per acre

**EA**—environmental assessment

**EAIP** – Environmental Impact Analysis Process

**EALS**—emergency airfield lighting system

**EID**—electrically initiated devices

**EIP**—equipment in place

**EIS**—Environmental Impact Statement

**EMC**—electromagnetic compatibility

**EMR**—electromagnetic radiation

**ENT**—ear, nose, throat

**EOR**—end of runway

**ETL**—engineering technical letter

**FAA**—Federal Aviation Administration

**FAA AC**—Federal Aviation Administration Advisory Circular

**FAAH**—Federal Aviation Administration Handbook

**FAR**—Federal Aviation Regulations

**FAR**—floor area ratio

**FBO**—forward base operations

**FBPAR**—Fixed Base Precision Approach Radar

**FBWOS**—Fixed Base Weather Observing Systems, formerly known as AWOS

**FCLP**—field carrier landing practice

**FCS**—flight control systems

**FFM**—far field monitor

**FHWA**—Federal Highway Administration

**FIM**—facility investment metric

**FM**—field manual (US Army)

**FOB**—forward operating base

**FONSI**—Finding of No Significant Impact

**FOD**—foreign object damage/foreign object debris

**FPS**—facility planning system

**FPS**—foot per second

**FSL**—flashing strobe light

**FSSZ**—fuel servicing safety zone

**ft**—foot

**ft-lb/lb**—foot-pound per pound

**gal**—gallon

**GCA**—ground control approach

**GCS**—Ground Control Station

**GDT**—Ground Data Terminal

**GM**—gallons per minute

**GPI**—ground point of intercept

**GPM**—gallons per minute

**GPS**—Global Positioning System

**G/S-3**—Operations Section (Army)

**GTOW**—Gross Takeoff Weight

**HH**—heavy helicopter

**HIRL**—high intensity runway edge lights

**HMA**—hot mix asphalt

**HMMWV-ECV**—High Mobility Multipurpose Wheeled Vehicles-Expanded Capacity Vehicles

**HPI**—hover position indicator

**HQ AFCEC**—Headquarters, Air Force Civil Engineer Center

**HQDA**—Headquarters, Department of the Army

**HQ USAFE**—Headquarters United States Air Forces in Europe

**HTC**—high temperature concrete

**HVAC**—heating, ventilation and air conditioning

**ICAO**—International Civil Aviation Organization

**ICUZ**—Installation Compatible Use Zone

**IEEE**—Institute of Electrical and Electronic Engineers

**IESNA**—Illuminating Engineering Society of North America

**IFR**—instrument flight rules

**ILS**—instrument landing system

**IMC**—instrument meteorological conditions

**IM**—inner marker

**in**—inch

**INST**—instruments

**IPL**—integrated priority list

**IR**—infrared

**LID**—low impact development

**JSF**—joint strike fighter

**k**—modulus of subgrade reaction

**kg**—kilogram  
**kHz**—kilohertz  
**km**—kilometer  
**km/h, kph**—kilometers per hour  
**kN**—kilonewton  
**kPa**—kilopascal  
**kW**—kilowatt  
**L**—liter  
**lb**—pound  
**LDA**—localizer type directional aid  
**LDIN**—lead-in lighting system  
**Ldn**—day/night average noise level  
**LHA**—landing, helicopter, assault  
**LHD**—landing, helicopter, deck  
**LM**—liters per minute  
**LOS**—line of sight  
**L/S**—liters per second  
**LSO**—landing signals officer  
**LSS**—landing site supervisor  
**LTA**—lighter-than-air  
**LZ**—landing zone  
**m**—meter  
**MAAS**—mobile aircraft arresting system  
**MAJCOM**—major command (Air Force)  
**MAJCOM/A7C**—major command civil engineer



**MAJCOM/CD**—major command deputy commander

**MALSF**—medium-intensity approach lighting system with sequenced flashers

**MALS**—medium-intensity approach lighting system

**MALSR**—medium-intensity approach lighting system with runway alignment indicator lights

**MATCT**—mobile air traffic control tower

**max**—maximum

**MCA**—military construction, Army

**MDA**—minimum descent altitude

**METNAV**—meteorological NAVAIDS detachment

**MFZ**—mandatory frangibility zone

**MHz**—megahertz

**MILCON**—military construction

**MIL-HDBK**—military handbook

**min**—minimum

**min**—minute

**MIRL**—medium-intensity runway edge lights

**MLG**—Main Landing Gear

**MLS**—microwave landing system

**mm**—millimeter

**MM**—middle marker

**MMLS**—mobile microwave landing system

**MOA**—military operating area

**MOB**—main operating base

**MOG**—maximum on ground

**MOTS**—Mobile Tower System

**mph**—miles per hour

**MQ**—Multi-role unmanned aircraft system

**MSL**—mean sea level

**MTI**—moving target indicator

**MTMC**—Military Traffic Management Command

**MUTCD**—Manual on Uniform Traffic Control Devices

**N/A**—not applicable

**NAFIG**—Navy Flight Information Group

**NATO**—North Atlantic Treaty Organization

**NAVAID or NavAIDS**—navigational aids

**NAVAIR**—Naval Air Systems Command

**NAVFAC**—Naval Facilities Engineering Command

**NAVFACENGCOM**—Naval Facilities Engineering Command

**NAVFACINST**—Naval Facilities Engineering Command instruction

**NAVFAC P**—Naval Facilities Engineering Command publication

**NAVFIG**—Naval Flight Information Group

**NAVSEA OP**—Naval Sea Operations Command operating instruction

**NDB**—non-directional beacon

**NEPA**—National Environmental Policy Act

**NFPA**—National Fire Protection Association

**NGB**—National Guard Bureau

**NLG**—Nose Landing Gear

**NOTAM**—Notice to Airmen

**N.T.S.**—not to scale

**NVG**—night vision goggles

**O&M**—operations and maintenance

**OCONUS**—outside the continental United States

**ODALS**—omnidirectional approach lighting system

**OH**—observation helicopter

**OIS**—obstacle identification surfaces

**OLF**—outlying field

**OLS**—optical landing system

**OM**—outer marker

**OPNAVINST**—operations naval instruction

**OPR**—office of primary responsibility

**PACAF/CD**—Pacific Air Forces Deputy Commander

**PAPI**—precision approach path indicator

**PAR**—precision approach radar

**PCASE**—Pavement-Transportation Computer Aided Structural Design and Evaluation

**PCC**—Portland cement concrete

**pci**—pound per cubic inch

**PCN**—Pavement Classification Number

**PES**—potential explosive site

**PGCS**—portable ground control station

**PGDT**—portable ground data terminal

**PI**—point of intersection

**PJHTC**—plain jointed high temperature concrete

**PJPCC**—plain jointed Portland cement concrete

**PPSL**—Predator primary satellite link

**POL**—petroleum, oil, lubricants

**Prime BEEF**—Prime Base Engineer Emergency Force

**psf**—pounds per square foot

**psi**—pounds per square inch

**psia**—pounds per square inch absolute

**psig**—pound per square inch gauge

**PUD**—planned unit development

**Q-D**—quantity-distance

**°R** —degree Rankine

**RAIL**—runway alignment indicator lights

**RAPCON**—radar approach control

**RCR**—runway condition reading

**RDO**—runway duty officer

**RDT&E**—research, development, testing, and evaluation

**RED HORSE**—Rapid Engineers Deployable Heavy Operations Repair Squadron

**REIL**—runway end identifier light

**RF**—radio frequency

**RIDS**—runway ice detection system

**RNM**—rotorcraft noise model

**ROD**—record of decision

**RPLANS**—real property planning and analysis system

**RQ**—Reconnaissance unmanned aircraft system

**RSU**—runway supervisory unit

**RSZ**—refueling safety zone

**RVL**—rolling vertical landing

**RVR**—runway visual range

**RWOS**—representative weather observation station

**SALS**—short approach lighting system

**SI**—International System of Units

**SLUCM**—Standard Land Use Coding Manual

**SOI**—statement of intent

**SPAWARS**—Space and Naval Warfare Systems Center

**SPAWARSYSCEN**—Space and Naval Warfare Systems Center

**SPR**—single-point receptacle

**SSALR**—simplified short approach lighting system with runway alignment indicator lights

**SSR**—Secondary Surveillance Radar

**STO**—short take-off

**STOVL**—short take-off, vertical landing

**STT**—Special Tactics Team

**T.O.**—technical order

**TAAS**—tactical area security system

**TACAN**—tactical air navigation

**TALS**—Tactical Automated Landing System

**TALS-TS**—Tactical Automated Landing System – Tracking System

**TDA**—tables of distribution and allowances

**TDZ**—touchdown zone

**TDP**—touchdown point

**TERPS**—terminal instrument procedures

**TM**—technical manual

**T/O**—Take-Off

**TO&E**—tables of organization and equipment

**TSC**—Transportation Systems Center

**TVOR**—terminal very high frequency omnidirectional range

**UAS**—Unmanned Aircraft System(s)

**UPS**—uninterruptible power supply

**UFC**—unified facilities criteria

**UH**—utility helicopter

**UHF**—ultra high frequency

**US**—United States

**USA**—United States Army

**USAASA**—US Army Aeronautical Services Agency

**USAASDE**—United States Army Aeronautical Services Detachment, Europe

**USACC**—U.S. Army Communication Command

**USACE**—U.S. Army Corps of Engineers

**USACE TSC**—U.S. Army Corps of Engineers Transportation Systems Center

**USACRC**—US Army Combat Readiness/Safety Center

**USAF**—United States Air Force

**USAFEI**—United States Air Forces in Europe Instruction

**USG**—United States Government

**USMC**—United States Marines Corps

**USN**—United States Navy

**USTRANSCOM**—U.S. Transportation Command

**VAP**—visual aid panel

**VASI**—visual approach slope indicator

**VCSA**—Vice Chief of Staff of the Army

**VF**—fixed-wing fighter

**VFR**—visual flight rules

**VGSI**—visual glide slope indicator

**VHF**—very high frequency

**VID**—visual identification

**VIP**—very important person

**VL**—vertical landing

**VLZMP**—visual landing zone marker panel

**VMC**—visual meteorological conditions

**VOR**—very high frequency omnidirectional range (radio)

**VORTAC**—very high frequency omnidirectional range (radio) and tactical air navigation

**V/STOL**—Vertical/Short Take-Off and Landing

**VTOL**—Vertical Takeoff and Landing

### ***Terms***

**Aborted Takeoff**—An unsuccessful takeoff operation due to power or other mechanical failures.

**Accident Potential Zone I (APZ I)**—The area beyond the clear zone that possesses a significant potential for accidents.

**Accident Potential Zone II (APZ II)**—The area beyond APZ I that has a measurable potential for accidents.

**AICUZ (Air Installations Compatible Use Zones)**—A DoD program designed to promote compatible development around military airfields and to protect the integrity of the installation's flying mission.

**Air Traffic**—Aircraft in operation anywhere in the airspace and within that area of an airfield or airport normally used for the movement of aircraft.

**Aircraft**—Fixed-wing (F/W) (airplane) and rotary-wing (R/W) (helicopter).

**Aircraft, Class A**—Aircraft listed under Class A Runways in Table 3-1 of this manual.

**Aircraft, Class B**—Aircraft listed under Class B Runways in Table 3-1 of this manual.

**Aircraft Arresting Barrier**—A device, not dependent on an aircraft hook, used to engage and absorb the forward momentum of an emergency landing or an aborted takeoff.

**Aircraft Arresting Cable**—That part of an aircraft arresting system which spans the runway surface or flight deck landing area and is engaged by the aircraft arresting gear.

**Aircraft Arresting Gear**—A device used to engage hook-equipped aircraft to absorb the forward momentum of a routine or emergency landing or aborted takeoff.

**Aircraft Arresting System**—A series of components used to engage and absorb the forward momentum of a routine or emergency landing or an aborted takeoff.

**Aircraft Operating Area**—For the purpose of this manual, the aircraft movement area is defined as that area of the airfield encompassed by the primary surface and the clear zones, as well as all apron areas and taxiways, regardless of their location. See paragraph 3-16.1 for the specific use of this term.

**Aircraft Wash Area**—A specially designed paved area for washing and cleaning aircraft.

**Aircraft Wash Rack**—Paved areas provided at all facilities to clean aircraft in conjunction with periodic maintenance.

**Aircraft Rinse Facility**—Paved areas provided at facilities to clean aircraft returning from flight and en route to the parking area.

**Airfield**—Area prepared for the accommodation (including any buildings, installations, and equipment), of landing and takeoff of aircraft.

**Airfield Elevation**—Established elevation, in terms of the nearest 300 mm (1 ft) above mean sea level, of the highest point of the usable landing area.

**Airfield Reference Point**—Designated geographical location of an airfield. It is given in terms of the nearest hundredth of a second of latitude and longitude. The position of the reference point must be as near to the geometric center of the landing area as possible, taking future development of the airfield into account.

**Airport**—Refers to a civil or municipal airfield.

**Airside Facilities**—Facilities associated with the movement and parking of aircraft. These include runways, taxiways, apron areas, associated navigational aids and imaginary surfaces.



**Airspace**—Space above ground or water areas which is or is not controlled, assigned, and/or designated.

**Airspace Boundaries**—The limits of imaginary surfaces.

**Air Traffic Navigation, Integration and Coordination System (ATNAVICS/AN/TPN-31)** — Provides air traffic control services for the rapid deployment of troops and equipment to remote locations where no operational airport control and landing system exists. Often deployed on Army airfields for training purposes.

**Alert Aircraft Parking**—Exclusive paved area for armed aircraft to park and have immediate, unimpeded access to a runway.

**Alert Pad**—Small paved areas provided for single alert aircraft parking.

**Approach Control**—Service established to control flights, operating under instrument flight rules (IFR), arriving at, departing from, and operating in the vicinity of airports by direct communication between approach control personnel and aircraft operating under their control.

**Approach-Departure Clearance Surface**—Inclined plane or combined inclined and horizontal planes arranged symmetrically about the runway centerline extended. The first segment or the beginning of the inclined plane is coincident with the ends and edges of the primary surface, and the elevation of the centerline at the runway end. The surfaces flare outward and upward from these points. See Chapter 3 for fixed-wing ADCS, Chapter 4 for rotary-wing ADCS and Chapter 7 for LZ ADCS dimensions.

**Apron**—A defined area, on an airfield, intended to accommodate aircraft for the purposes of loading or unloading passengers or cargo, refueling, parking or maintenance.

**Apron, Aircraft Access**—See Apron, Hangar Access.

**Apron, Alert**—A designated area for multiple alert aircraft parking.

**Apron Edge**—See Edge of Apron.

**Apron, Hangar Access**—Hangar access aprons are paved areas connecting hangars with adjacent aircraft aprons when the hangar is located at the outer boundary of the apron clearance distance. Hangars located beyond the apron clearance distance may be connected to the main apron with a taxiway or a towway.

**Apron, Holding (Engine Run up Area)**—A paved area adjacent to the taxiway near the runway ends where final preflight warm-up and engine and instrument checks are performed.

**Apron, Parking**—Parking apron is a designated paved area on an airfield intended to accommodate fixed-and rotary-wing aircraft for parking.

**Arming and Disarming**—Loading and unloading of missiles, rockets, and ammunition in aircraft.

**Arrestment Capable Aircraft**—Aircraft whose flight manual specifies arrestment procedures.

**Autorotation Lane**—A helicopter landing lane or designated area on a runway used for practicing landings under simulated engine failure or certain other emergency conditions. Also known as a slide area when designed specifically for skid-type helicopters.

**Aviation Facility**—Combination of land, airspace, pavements and buildings which are needed to support an aviation movement or action. An aviation facility can be an airfield, heliport, or helipad. The aviation facility includes “airside” and “landside” facilities.

**Aviation Intermediate Maintenance (AVIM)**—For Army, units that provide mobile, responsive “one-stop” maintenance and repair of equipment to return to user.

**Aviation Movement or Action**—An aviation movement or action includes but is not limited to: the landing and takeoff of aircraft; readiness of aircraft; flight training of pilots; loading and unloading of aircraft; and the maintenance and fueling of aircraft.

**Aviation Unit Maintenance (AVUM)**—For Army, activities staffed and equipped to perform high frequency “on aircraft” maintenance tasks required to retain or return aircraft to a serviceable condition.

**Avigation Easement**—A legal right obtained from a property owner to operate aircraft over that property and to restrict the height of any construction or growth on that property.

**Beam Wind Component**—Wind velocities perpendicular to the axis of the runway centerline used to measure the degree by which a runway pattern covers incident wind.

**Blast Protective Area**—Area at the ends of the runways and taxiways protected by pavement construction against jet blast erosion.

**Circling Approach Area**—Area in which aircraft circle to land under visual conditions.

**Clear Zone**—Surface on the ground or water beginning at the runway end and symmetrical about the runway centerline extended.

**Compass Calibration Pad**—A paved area in an electromagnetically quiet zone where an aircraft's compass is calibrated.

**Compass Rose**—A graduated circle, usually marked in degrees, indicating directions and printed or inscribed on an appropriate medium.

**Conical Surface**—An imaginary surface that extends from the periphery of the inner horizontal surface outward and upward at a slope of 20 horizontal to one for a horizontal distance of 2,133.6 m (7,000 ft) to a height, 152.4 m (500 ft) above the established airfield elevation. The conical surface connects the inner horizontal surface with the outer horizontal surface. It applies to fixed-wing installations only.

**Construction Waiver**—A temporary airfield waiver used to identify, coordinate, and approve construction activity on or near the airfield. The installation commander, or equivalent, is the construction waiver approval authority. Construction waivers apply to airfield systems, facilities, and on-base facilities where construction will require equipment or stockpile areas that may adversely affect flying operations. For more information about construction waivers, see Appendix B, Section 1.

**Controlling Obstacle**—Highest obstacle relative to a prescribed plane within a specified area. In precision and non-precision approach procedures where obstacles penetrate the approach surface, the controlling obstacle is the one which results in the requirement for the highest decision height (DH) or minimum descent altitude (MDA). For departure procedures, the obstacle that drives the highest climb gradient to the highest climb to altitude.

**Correctable Obstruction**—An obstruction to aircraft operations or air navigation that can be removed, modified, or relocated to comply with airfield safety criteria with a reasonable level of effort as determined by the MAJCOM or USAASA as applicable.

**Crosswind Runway**—A secondary runway that is required when the primary runway orientation does not meet crosswind criteria (see Appendix B, Section 4.).

**Decision Height (DH) / Decision Altitude (DA)**— Specified for a precision approach, at which a missed approach procedure must be initiated if the required visual reference has not been established. Decision altitude (DA) is referenced to mean sea level (MSL) and decision height (DH) is referenced to the threshold elevation.

**Displaced Threshold**—A runway threshold that is not at the beginning of the full-strength runway pavement. Displacement of a threshold reduces the length of runway available for landings. The portion of the runway behind a displaced threshold may be available for takeoffs and, depending on the reason for the displacement, may be available for takeoffs and landings from the opposite direction.

**Edge of Apron**—Boundary of an apron, marked by painted stripe in accordance with pavement marking manual.

**Exemption (Air Force only)**—A facility or other item constructed under a previous standard. Exemptions must be programmed for replacement away from the airfield environment at the end of their useful life cycle. Also, see Chapter 1.

**Fixed-Wing Aircraft**—A powered aircraft that has wings attached to the fuselage so that they are either rigidly fixed or swing-wing, as distinguished from aircraft with rotating wings, like a helicopter.

**Flight Path**—Line connecting the successive positions occupied, or to be occupied, by an aircraft, missile, or space vehicle as it moves through air or space.

**Fuel Servicing Safety Zone (FSSZ)**—The FSSZ is the area required for safety around pressurized fuel carrying servicing components; i.e. servicing hose, fuel nozzle, single point receptacle (SPR), hydrant hose car, ramp hydrant connection point, etc. and around aircraft fuel vent outlets. The fuel servicing safety zone is established and maintained during pressurization and movement of fuel.

**Full Stop Landing**—Touchdown, rollout, and complete stopping of an aircraft to zero speed on runway pavement.

**Grade—Also Gradient**—A slope expressed in percent. For example, a 0.5 percent grade means a 0.5-meter (-foot) slope in 100 meters (feet). All grades may be positive or negative unless otherwise specifically noted.

**Ground Point of Intercept (GPI)**—A point in the vertical plane of the runway centerline or center of a helipad at which it is assumed that the straight line extension of the glide slope (flight path) intercepts the approach surface base line (TM 95-226).

**Hardstand**—A term used synonymously with Apron. See Apron definition.

**Helicopter**—Aircraft deriving primarily elements of aerodynamic lift, thrust and control from one or more power driven rotors rotating on a substantially vertical axis.

**Helicopter(Light)**— Helicopters with a gross weight of 2,722 kg (6,000 lb) or less.

**Helicopter(Medium)**— Helicopters with a gross weight of 2723 to 5,443 kg (6,001 to 12,000 lb).

**Helicopter(Heavy)**— Helicopters with a gross weight over 5,443 kg (12,000 lb).

**Helicopter Parking Space, Type 1 (Army Only)**—In this configuration, rotary-wing aircraft are parked in a single lane, which is perpendicular to the taxilane.

**Helicopter Parking Space, Type 2 (Army Only)**—In this configuration, rotary-wing aircraft are parked in a double lane, which is parallel to the taxilane.

**Helicopter Runway**—A prepared surface used for the landing and takeoff of helicopters requiring a ground run.

**Helipad**—A prepared area designated and used for takeoff and landing of helicopters (includes touchdown and hoverpoint.)

**Helipad, IFR**—Helipad designed for IFR. IFR design standards are used when an instrument approach capability is essential to the mission and no other instrument landing facilities, either fixed-wing or rotary-wing, are located within an acceptable commuting distance to the site.

**Helipad, Limited Use**—A VFR rotary-wing facility for use by AH, OH, HH and UH helicopters. These type helipads support only occasional operations at special locations such as hospitals, headquarters facilities, missile sites, and other similar locations. They may also be located on airfields where one or more helipads are required to separate operations of helicopters such as OH, UH, HH and AH) from fixed-wing or other helicopter operations.

**Heliport**—A facility designed for the exclusive operating, basing, servicing and maintaining of rotary-wing aircraft (helicopters). The facility may contain a rotary-wing runway and/or helipads.

**Heliport or Helipad Elevation**—Established elevation, in terms of the nearest 300 mm (1 ft) above mean sea level, based on the highest point of the usable landing area.

**High-Speed Taxiway Turnoff**—A taxiway leading from a runway at an angle which allows landing aircraft to exit a runway at a high speed.

**Holding Position**—A specified location on the airfield, close to the active runway and identified by visual means, at which the position of a taxiing aircraft is maintained in accordance with air traffic control instructions.

#### **Horizontal Surfaces, Fixed-Wing:**

**Inner Horizontal Surface**—An imaginary plane 45.72 m (150 ft) above the established airfield elevation. The inner boundary intersects with the approach-departure clearance surface and the transitional surface. The outer boundary is formed by scribing arcs with a radius 2,286.0 m (7,500 ft) from the centerline of each runway end, and interconnecting those arcs with tangents.

**Outer Horizontal Surface**—An imaginary plane 152.4 m (500 ft) above the established airfield elevation extending outward from the outer periphery of the conical surface for a horizontal distance of 9,144.0 m (30,000 ft).

**Horizontal Surface, Rotary-Wing**—An imaginary plane at 45.72 m (150 ft) above the established heliport or helipad elevation. The inner boundary intersects with the approach-departure clearance surface and the transitional surface. The outer boundary is formed by scribing an arc at the end of each runway, and connecting the arcs with tangents, or by scribing the arc about the center of the helipad. See Chapter 4 for dimensions.

**Hover**—A term applied to helicopter flight when the aircraft: (1) maintains a constant position over a selected point (1 to 3 m (3 to 10 ft) above ground), and (2) is taxiing (airborne) (1 to 3 m (3 to 10 ft) above ground) from one point to another.

**Hoverlane**—A designated aerial traffic lane for the directed movement of helicopters between a helipad or hoverpoint and the servicing and parking areas of the heliport or airfield.

**Hoverpoint**—Prepared and marked surface at a heliport or airfield used as a reference or central point for arriving or departing helicopters.

**Imaginary Surfaces.** Surfaces in space established around airfields in relation to runway(s), helipad(s), or helicopter runway(s) that are designed to define the obstacle free airspace around the airfield. The imaginary surfaces for DoD airfields are the primary surface, the approach-departure clearance surface, the transitional surface, the graded area of the clear zone, the inner horizontal surface, the conical surface (fixed-wing only), and the outer horizontal surface (fixed-wing only).

**Ingress/Egress, Same Direction**—One approach-departure route to and from the helipad exists. The direction from which the rotary-wing aircraft approaches the helipad (ingress) is the only direction which the rotary-wing aircraft departs (egress) from the helipad. Typically, the helipad is surrounded by obstacles on three sides which make approaches from other directions impossible. For example, if the rotary-wing aircraft approaches from the southwest, it must also depart to the southwest.

**Ingress/Egress, Two Direction**—Rotary-wing aircraft can approach and depart the helipad from two directions (one direction and the opposite direction). (See also Ingress/Egress, Same Direction.)

**Instrument Runway**—Runway equipped with electronic navigation aids for which a precision or non-precision approach procedure is approved.

**Instrument Flight Rules (IFR)**—Rules that govern the procedure for conducting instrument flight. Also see Instrument Meteorological Conditions.

**Instrument Landing System**—System of ground equipment designed to provide an approach path for exact alignment and descent of an aircraft on final approach to a runway. The ground equipment consists of two highly directional transmitting systems and, along the approach, three (or fewer) marker beacons. The directional transmitters are known as the localizer and glideslope transmitters.

**Instrument Meteorological Conditions**—Meteorological conditions expressed in terms of visibility, distance from cloud, and ceiling; less than minimums specified for visual meteorological conditions.

**Intermediate Area**—Area between runways and between runways and taxiways that is graded or cleared for operational safety.

**Joint/Shared Use Airfield**—Airports that are shared by a civilian DoD agency covered under the *Airports and Airway Improvement Act of 1982* (Public Law 97-248, Sep 3, 1982, 49 USC, APP 2201). Only those facilities (i.e., runways/taxiways) that are used by both civilian and DoD agencies are considered shared/joint use. All other facilities (parking ramps, hangars, terminals, and so forth) are the sole property of the using agency. An installation where agreements exist among the DoD, civil, and host nation authorities for joint use of all or a portion of airfield facilities.

**Landing Area**—See Takeoff and Landing Area.

**Landing Field**—Any area of land consisting of one or more landing strips, including the intermediate area, that is designed for the safe takeoff and landing of aircraft.

**Landing Lane**—A defined lane on the airfield used for simultaneous takeoff and landings of multiple (up to four at one time) helicopters. Landing lanes are used at airfields or heliports when a high density of helicopters are parked on an apron or in the process of takeoff and landings.

**Landing Rollout**—Distances covered in stopping the aircraft, when loaded to maximum landing weight, following touchdown using standard operation and braking procedures on a hard, dry-surfaced, level runway with no wind.

**Landing Strip**—Portion of an airfield that includes the landing area, the end zones, and the shoulder areas; also known as a flight strip.

**Landing Zone (LZ)**—A prepared or semi-prepared (unpaved) airfield used to conduct operations in an airfield environment similar to forward operating locations. LZ runways are typically shorter and narrower than standard runways.

**Landside Facilities**—Landside facilities are facilities not associated with the movement and parking of aircraft but are required for the facilities' mission. These include aircraft maintenance areas, aviation support areas, fuel storage and dispensing, explosives and munitions areas and vehicular needs.

**Large Transport Aircraft**—Transport aircraft with a wing span of 33.5 m (110 ft) or greater.

**Light Bar**—Set of lights arranged in a row perpendicular to the light system centerline.

**Line Vehicle**—Vehicle used on the landing strip, such as a crash fire truck or tow tractor.

**Localizer**—Directional radio beacon which provides to an aircraft an indication of its lateral position relative to a predetermined final approach course.

**Localizer Type Directional Aid (LDA)**—A NAVAID used for non-precision instrument approaches with utility and accuracy comparable to a localizer but which is not part of a

complete ILS. The LDA is not aligned with the runway. The alignment is greater than 3 degrees ( $3^\circ$ ) and less than 30 degrees ( $30^\circ$ ) from the runway centerline.

**Magnetic North**—Direction indicated by the north-seeking pole of a freely suspended magnetic needle, influenced only by the earth's magnetic field.

**Magnetic Variation**—At a given place and time, the horizontal angle between the true north and magnetic north measured east or west according to whether magnetic north lies east or west of true north.

**Magnetically Quiet Zone**—A location where magnetic equipment, such as a compass, is only affected by the earth's magnetic forces.

**Non-Precision Approach**—Approach flown by reference to electronic navigation aids in which glideslope information is not available.

**Non-Instrument Runway**—Runway intended for operating aircraft under VFR.

**Obstacle**—An existing object, natural growth, or terrain, at a fixed geographical location, or which may be expected at a fixed location within a prescribed area, with reference to which vertical clearance is or must be provided during flight operations. *Fixed Obstacles* include man-made or natural features such as buildings, trees, rocks and terrain irregularities. *Mobile Obstacles* include parked aircraft, parked and moving vehicles, railroad cars and similar equipment. Taxiing aircraft are exempt from this restriction. Vehicles in performance of official duties, such as emergency vehicles, maintenance vehicles and inspection vehicles, are exempt from this restriction only when authorized by Airfield Management and operating the vehicle in accordance with local driving rules and regulations.

**Obstacle Clearance**—Vertical distance between the lowest authorized flight altitude and a prescribed surface within a specified area.

**Obstruction**—Natural or man-made object that violates airfield or heliport clearances or projects into imaginary airspace surfaces. Navy and Marine Corps see UFC 2-000-05N.

**Overrun Area**—Area the width of the runway plus paved shoulders extending from the end of the runway to the outer limit of the end zone. This portion is a prolongation of the runway which is the stabilized area.

**Parking, Aircraft Undergoing Maintenance**—Apron parking space is provided for parking aircraft which must undergo maintenance.

**Parking, Alert Aircraft**—Parking for aircraft that must be in flight upon short notice.

**Parking, Operational Aircraft**—Parking for operational aircraft assigned to a particular installation.



**Parking, Transient Aircraft**—Parking for transient aircraft (non-operational) at the installation, but not assigned there.

**Parking, Transport Aircraft**—Parking for transport aircraft carrying cargo and personnel which must be loaded and unloaded.

**Pass**—The movement of an aircraft over a specific spot or location on a pavement feature.

**Pavement (Paved Surface)**—A durable weather and abrasion resistant surface made from a prepared or manufactured material placed on an established base. General categories of pavements are flexible and rigid.

**Permanent Waiver**—See **Waiver, Permanent**.

**Permissible Deviation (Air Force and Army only)**—Airfield support facilities that are not required to meet airfield clearance criteria; however, they must meet siting criteria specified in Appendix B, Section 13, of this UFC.

**Power Check**—Full power test of an aircraft engine while the aircraft is held stationary.

**Power Check Pad**—Aircraft power check pad is a paved area, with an anchor block in the center, used to perform full-power engine diagnostic testing of aircraft engines while the aircraft is held stationary.

**Precision Approach**—Approach in which azimuth and glideslope information are provided to the pilot.

**Primary Surface (Fixed-Wing Runways)**—An imaginary surface symmetrically centered on the runway, extending 60.96 m (200 ft) beyond each runway end. The width varies depending upon the class of runway and coincides with the lateral clearance distance. The elevation of any point on the primary surface is the same as the elevation of the nearest point on the runway centerline.

**Primary Surface (Rotary-Wing Runways and Landing Lanes)**—Imaginary surface symmetrically centered on the runway, extending beyond the runway ends. The width and length depends upon whether the runway/landing lane is to accommodate VFR or IFR operations. The lateral clearance distance coincides with the width of the primary surface. The elevation of any point on the primary surface is the same as the elevation of the nearest point on the runway centerline.

**Relocated Threshold**-- A threshold that is located at a point on the runway other than the beginning of the full-strength pavement and the paved area between the former threshold and the relocated threshold is no longer used for landing or takeoff of aircraft, but may be used for taxiing aircraft.

**Runway**—A defined rectangular area of an airfield or heliport, with no curves or tangents, prepared for the landing and takeoff run of aircraft along its length.

**Runway (Class A)**—Class A runways are primarily intended for small light aircraft. Ordinarily, these runways have less than 10 percent of their operations involving aircraft in the Class B category. These runways are normally less than 2,440 m (8,000 ft).

**Runway (Class B)**—Class B runways are all fixed-wing runways that accommodate normal operations of Class B Aircraft.

**Runway End**—As used in this manual, the runway end is where the normal threshold is located. When the runway has a displaced threshold, the responsible airfield authority will evaluate each individual situation and, based on this evaluation, will determine the point of beginning for runway and airspace imaginary surfaces.

**Runway Exit**—Taxiway pavement provided for turnoffs from the runway to a taxiway either at normal or high speed.

**Runway, Parallel**—Two or more runways at the same airport whose centerlines are parallel. In addition to runway number, parallel runways are designated as L (left) and R (right) or, if three parallel runways exist, L (left), C (center), and R (right).

**Runway, Rotary-wing**—Runway for rolling landings and takeoff of rotary-wing aircraft. The rotary-wing runway allows for a helicopter to quickly land and roll to a stop compared to the hovering stop used during a vertical helipad approach.

**Runway Threshold**—A line perpendicular to the runway centerline designating the beginning of that portion of a runway usable for landing.

**Runway Visual Range**—The maximum distance in the direction of takeoff or landing from which the runway, or the specified lights or markers delineating it, can be seen from a position above a specified point on its centerline at a height corresponding to the average eye-level of pilots at touchdown.

**Service Point**—Receptacle, embedded in certain airfield pavements, containing outlets for utilities required to service aircraft.

**Short Takeoff And Vertical Landing (STOVL)**— a fixed-wing aircraft capable of clearing a 15 m (50 ft) obstacle within 450 m (1,500 ft) of commencing take-off run, and capable of landing vertically. This term only applies to F-35B aircraft.

**Shoulder**—Prepared (paved or unpaved) area adjacent to the edge of an operational pavement.

**Slide Area, Helicopter**—Specially prepared but usually unpaved area used for practicing helicopter landings under simulated engine failure or certain other emergency conditions. VFR Helicopter runway criteria apply to these type facilities. (Also known as a Skid Pad.)

**Slope Ratio**—Slope expressed in meters (feet) as a ratio of the horizontal to the vertical distance. For example, 50:1 means 50 m horizontal to 1 m vertical (50 ft horizontal to 1 ft vertical).

**Standard VFR Helipad**—Helipad designed to VFR. VFR design standards are used when no requirement exists or will exist in the future for an IFR helipad.

**Standby Parking Pad**—At individual helipad sites where it is necessary to have one or more helicopters on standby, an area adjacent to the helipad, but clear of the landing approach and transitional surfaces.

**Sunshade**—A cover, usually semi-circular in shape, to protect aircraft from the sun's ultraviolet rays. For Air Force, see AFI 21-136 *Aircraft Sunshade Management*.

**Suppressed Power Check Pad**—Enclosed power check pad, referred to as a "hush house," where full power checks of jet engines are performed.

**Takeoff and Landing Area**—Specially prepared or selected surface of land, water, or deck designated or used for takeoff and landing of aircraft.

**Takeoff Safety Zone**—Clear graded area within the approach-departure zone of all VFR rotary-wing facilities. The land use of this area is comparable to the clear zone area applied to fixed-wing facilities.

**Taxilane**—Designated path marked through parking, maintenance or hangar aprons, or on the perimeter of such aprons to permit the safe ground movement of aircraft operating under their own power.

**Taxilane, Interior (secondary taxi routes)**—Taxilane which provides a secondary taxi route to individual parking positions or a hangar and is not intended or used as a primary taxi route for through traffic.

**Taxilane, Peripheral**—Taxilane located along the periphery of an apron that may be considered a primary or a secondary taxi route. Provide wing tip clearance commensurate with the intended use. See Taxilane, Interior; Taxilane, Through; and Table 6-1, Items 5 and 6.

**Taxilane, Through (primary taxi routes)**—A taxilane providing a route through or across an apron which is intended as a primary taxi route for access to other taxilanes, aprons, taxiways or the runway.

**Taxitrak**—A specially prepared or designated path, on an airfield other than mass parking areas, on which aircraft move under their own power to and from taxiways to dispersed platforms.

**Taxiway**—A specially prepared or designated path, on an airfield or heliport other than apron areas, on which aircraft move under their own power to and from landing, service and parking areas.

**Taxiway, Apron Entrance**—Taxiway which connects a parallel taxiway and an apron.

**Taxiway, End Turnoff (Entrance Taxiway) (Connecting Taxiway) (Crossover Taxiway)**—A taxiway located at the end of the runway that serves as both an access and departure location for aircraft at the runway thresholds.

**Taxiway, High-Speed Turnoff (High-Speed Exit) (Acute-angled Exit Taxiway)**—A taxiway located intermediate of the ends of the runway and "acute" to the runway centerline to enhance airport capacity by allowing aircraft to exit the runways at a faster speed than normal turnoff taxiways allow. Aircraft turning off runways at high speeds (maximum 100 km/h (55 knots)) require sufficient length for a high-speed turnoff taxiway to decelerate to a full stop before reaching the parallel taxiway.

**Taxiway, Normal Turnoff (Ladder Taxiway) (Intermediate Taxiway) (Exit Taxiway)**—A taxiway located intermediate of the end of the runway, typically perpendicular to the runway centerline that allows landing aircraft to exit and clear runways as soon as possible.

**Taxiway, Parallel**—Taxiway which parallels the runway. The curved connections to the end of the runway permit aircraft ground movement to and from the runway and are considered part of the parallel taxiway when there are no other taxiway exits on the runway.

**Taxiway Turnoff**—A taxiway leading from a runway to allow landing aircraft to exit and clear the runway after completing their initial landing roll.

**Temporary Waiver**—See **Waiver, Temporary**.

**Threshold Crossing Height**—Height of the straight-line extension of the guide slope above the runway at the threshold.

**Tie-down Anchor**—A device, installed in certain airfield pavements, to which lines tying down an aircraft are secured. Electrical grounding may be provided. This is not to be confused with the aircraft trim pad and thrust anchor shown in Appendix B, Section 15.

**Touchdown Point**—Designated location on a landing lane, taxiway, or runway for permitting more rapid launch or recovery of helicopters in a high-density area.

**Towway**—Paved surface over which an aircraft is towed.

**Transitional Surface**— An imaginary surface that extends outward and upward at right angles to the runway centerline and the runway centerline extended at a slope ratio of 7H:1V. The transitional surface connects the primary and the approach-departure clearance surfaces to the inner horizontal, the conical, and the outer horizontal surfaces.

**Transitional Surfaces (Rotary-Wing)**—The imaginary plane which connect the primary surface and the approach-departure clearance surface to the horizontal surface,

or extends to a prescribed horizontal distance beyond the limits of the horizontal surface. Each surface extends outward and upward at a specified slope measured perpendicular to the runway centerline or helipad longitudinal centerline (or centerlines) extended.

**True North**—Direction from an observer's position to the geographic North Pole. The north direction of any geographic meridian.

**Unsuppressed Power Check Pad**—A power check pad without an enclosure or other type of noise suppressor. It is generally used as a backup or interim facility to a suppressed power check pad. The unsuppressed power check pad, in its simplest form, is a paved area on which full power engine diagnostic testing can be performed without noise or jet blast limitations.

**Visual Flight Rules (VFR)**—Rules that govern the procedures for conducting flight under visual conditions. Also see Visual Meteorological Conditions.

**Visual Meteorological Conditions (VMC)**—Weather conditions in which visual flight rules apply; expressed in terms of visibility, ceiling height, and aircraft clearance from clouds along the path of flight. When these criteria do not exist, instrument meteorological conditions prevail and IFR must be complied with. Also see Visual Flight Rules.

**Vertical Sight Distance**—The longitudinal distance visible from one location to another. Usually, a height above the pavement surface is also defined.

**Vertical/Short Takeoff and Landing (V/STOL)**—A tilt-rotor vertical takeoff and landing aircraft that has the ability to operate as either a fixed- or rotary-wing aircraft. This applies to V-22 and AV-8 aircraft.

**Waiver, Construction**—A temporary airfield waiver used to identify, coordinate and approve construction activity on or near the airfield. The installation commander is the approval authority for construction waivers. See Appendix B, Section 1, for additional information.

**Waiver, Permanent (Army)**—An airfield waiver established for violations that cannot be reasonably corrected and pose little or no risk to flying operations. Such violations are typically caused by natural topographic features. See Appendix B, Section 1 for approval authority.

**Waiver, Permanent (Air Force)**—Permanent waivers are established for criteria violations that cannot be reasonably met. See Paragraph B1-2.1.2 for details.

**Waiver, Temporary (Army)**—An airfield waiver established to address safety mitigation for correctable obstructions or violations of other airfield criteria such as grades. See Appendix B, Section 1 for approval authority.

**Waiver, Temporary (Air Force)**— Temporary waivers are established for criteria violations that can be corrected within eight years. See Section B1-2.1.3 for details.

**Wind Rose**—A diagram showing the relative frequency and strength of the wind in correlation with a runway configuration and in reference to true north. It provides a graphic analysis to obtain the total wind coverage for any runway direction.

**Wind Direction**—Direction from which the wind is blowing in reference to true north.

CANCELLED